

Owner's Manual

Model
XR-7

MULTITRACKER

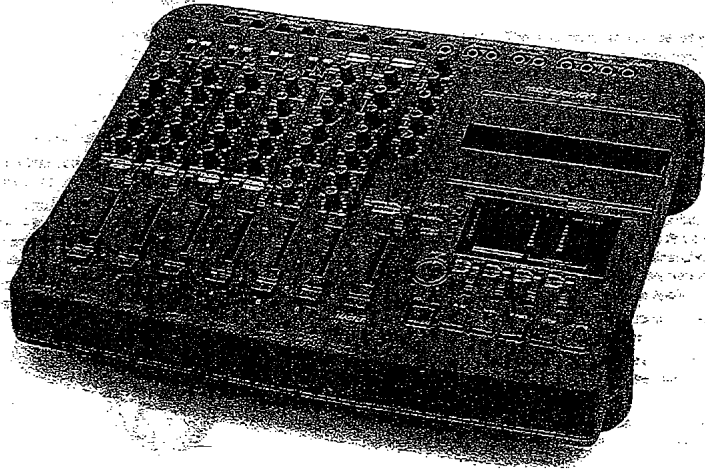

Fostex

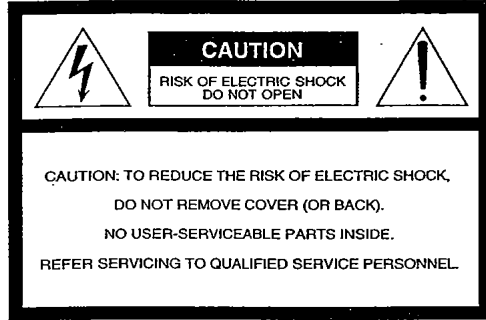

CAUTION:
TO PREVENT ELECTRIC SHOCK, MATCH WIDE BLADE OF PLUG TO WIDE SLOT, FULLY INSERT.

ATTENTION:
POUR ÉVITER LES CHOC ÉLECTRIQUES, INTRODUIRE LA LAME LA PLUS LARGE DE LA FICHE DANS LA BORNE CORRESPONDANTE DE LA PRISE ET POUSSER JUSQU'AU FOND.



The lightning flash with the arrowhead symbol, within an equilateral triangle, is intended to alert the user to the presence of uninsulated "dangerous voltage" within the product's enclosure that may be of sufficient magnitude to constitute a risk of electric shock to persons.



The exclamation point within an equilateral triangle is intended to alert the user to the presence of important operating and maintenance (servicing) instructions in the literature accompanying the appliance.

"WARNING"

"TO REDUCE THE RISK OF FIRE OR ELECTRIC SHOCK, DO NOT EXPOSE THIS APPLIANCE TO RAIN OR MOISTURE."

SAFETY INSTRUCTIONS

1. Read Instructions – All the safety and operating instructions should be read before the appliance is operated.
 2. Retain Instructions – The safety and operating instructions should be retained for future reference.
 3. Heed Warnings – All warnings on the appliance and in the operating instructions should be adhered to.
 4. Follow Instructions – All operating and use instructions should be followed.
 5. Water and Moisture – The appliance should not be used near water – for example, near a bathtub, washbowl, kitchen sink, laundry tub, in a wet basement, or near a swimming pool, and the like.
 6. Carts and Stands – The appliance should be used only with a cart or stand that is recommended by the manufacturer.
-
- A appliance and cart combination should be moved with care. Quick stops, excessive force, and uneven surfaces may cause the appliance and cart combination to overturn.
7. Wall or Ceiling Mounting – The appliance should be mounted to a wall or ceiling only as recommended by the manufacturer.
 8. Ventilation – The appliance should be situated so that its location or position does not interfere with its proper ventilation. For example, the appliance should not be situated on a bed, sofa, rug, or similar surface that may block the ventilation openings; or placed in a built-in installation, such as a bookcase or, cabinet that may impede the flow of air through the ventilation openings.
 9. Heat – The appliance should be situated away from heat sources such as radiators, heat registers, stoves, or other appliances (including amplifiers) that produce heat.
 10. Power Sources – The appliance should be connected to a power supply only of the type described in the operating instructions or as marked on the appliance.
 11. Grounding or Polarization – The precautions that should be taken so that the grounding or polarization means of an appliance is not defeated.
 12. Power Cord Protection – Power supply cords should be routed so that they are not likely to be walked on or pinched by items placed upon or against them, paying particular attention to cords at plugs, convenience receptacles, and the point where they exit from the appliance.
 13. Cleaning – The appliance should be cleaned only as recommended by the manufacturer.
 14. Nonuse Periods – The power cord of the appliance should be unplugged from the outlet when left unused for a long period of time.
 15. Object and Liquid Entry – Care should be taken so that objects do not fall and liquids are not spilled into the enclosure through openings.
 16. Damage Requiring Service – The appliance should be serviced by qualified service personnel when:
 - A. The power supply cord or the plug has been damaged; or
 - B. Objects have fallen, or liquid has been spilled into the appliance; or
 - C. The appliance has been exposed to rain; or
 - D. The appliance does not appear to operate normally or exhibits a marked change in performance; or
 - E. The appliance has been dropped, or the enclosure damaged.
 17. Servicing – The user should not attempt to service the appliance beyond that described in the operating instructions. All other servicing should be referred to qualified service personnel.

Introduction

Thank you for purchasing the Fostex XR-7.

The XR-7 is a multitracker that combines a multi-function mixer with six inputs (two of which accept mic signals) and AUX of "B1 alternate mechanism," and a high-performance four-track cassette recorder with full-logic controls, a high-quality, double-speed (9.5cm/s) tape transport, and Dolby C Noise Reduction system.

The XR-7 offers versatility and advanced functionality, including four-track simultaneous recording, punch in/out by footswitch (with the rehearsal function), zero return/auto-playback, operation indicators (that show operation status), and instrument rehearsal mode at half speed (4.75cm/s).

The XR-7 allows you to create high-quality sounds easily, using techniques such as playing four different instruments by yourself, track bouncing (ping-pong), using the AUX send/return jacks for effect processing, and tape sync mixdown by MIDI/TAPE multi-mix function.

To take full advantage of the XR-7, please read this manual carefully before using the recorder and retain it for future reference.

Table of Contents

Introduction	2	STEP 1: Direct Recording	20
Precautions (please read before use)	2	STEP 2: Recording Six Sound Sources to Track 1 and 2	22
CHAPTER 1. How to use the XR-7		STEP 3: Overdubbing - 1	24
Some things you can do with the XR-7	3	STEP 4: Overdubbing - 2	26
Some important terms used in this manual	4	STEP 5: Mixdown	28
About cassette tapes for the XR-7	7	CHAPTER 5. Advanced Operations	
CHAPTER 2. Control panel and front and rear panels		(After you have mastered basic operation)	30
Control panel	9	STEP 6: Punch in/out	30
Input/output jacks	12	STEP 7: Ping-pong recording	32
CHAPTER 3. Preparation		STEP 8: Tape Sync Recording (MIDI/TAPE Multi-mix function)	34
Key points of operation and settings	14	STEP 8-1:	34
CHAPTER 4. Basic Operation (Start Recording)		STEP 8-2:	35
One step at a time	19	Troubleshooting	37
Initial settings on the XR-7	19	Maintenance	38
		Specifications	39
		Block Diagram	40

Precautions (please read before use)

Power supply

- When unplugging the AC adaptor from the outlet, be sure to grasp the adaptor. Attempting to unplug it by pulling on the AC cable may damage the wiring.
- It is hazardous to use a power cable which has been cut or frayed. If the power cable becomes damaged, immediately stop using it, and have it repaired.
- Do not plug in or unplug the AC adaptor when your hands are wet. Doing so may result in dangerous electric shock.
- Do not open the unit or touch the parts inside. Doing so may result in dangerous electric shock, and may damage the unit.
- Do not allow water or other liquids, flammable materials, or metal objects such as pins to get inside the unit. These things may cause electrical shock, and may damage the unit. If the unit should become wet, unplug the AC adaptor from the AC outlet, and contact your authorized service station.
- When turning the power on, turn this unit on before turning on other equipment connected to this unit. Doing so will avoid possible damage to the other

equipment. Also, when connecting or disconnecting cables to or from the unit's input or output jacks, make sure that the INPUT fader and AUX volume of that channel are turned down to a level of 0.

- When the AC adaptor is connected to an AC outlet, it will continue to draw small amounts of power even if the switch is set turned off (STANDBY). If you will not be using the unit for an extended length of time, be sure to unplug the AC adaptor from the outlet.

Location

- Avoid using the unit in the following types of location.
 - * Locations of extreme low or high temperatures, or extreme changes in temperature.
 - * Locations with excessive moisture or dust.
 - * Locations where direct sunlight falls for an extended time, or near a stove or other source of heat.
 - * Locations where electrical voltage is not steady.
 - * Unstable locations or where there is heavy vibration.
 - * Near strong magnetic fields (on top of a television or speaker).

How to use the XR-7

Some things you can do with the XR-7

Radio cassette players and stereo cassette decks record and play back stereo sound on both sides of a tape: side A and side B. As shown in the diagram, a cassette tape is divided into four tracks. Two are used for side A and two for side B.

However, the XR-7 uses all four tracks at once (i.e., as a single side) and is able to record each track independently, allowing you to record instruments or vocal parts separately.

This chapter provides examples of the possibilities of the XR-7, and explains some basic concepts you should understand.

Standard Cassette Deck

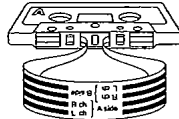

Model XR-7

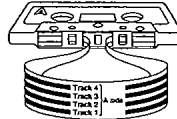

Recording a four-piece band

The XR-7 has four tracks, and a different sound source can be recorded independently on each track.

Here's how you might record a four-piece band (drums, bass, guitar, and keyboard). Record the drums on one track. Then, while you play back the drum part you recorded, record the bass part on a second track. (This process is called "overdubbing.") As shown below, use the same procedure to record the guitar and then the keyboard on the remaining tracks to complete a four track recording.

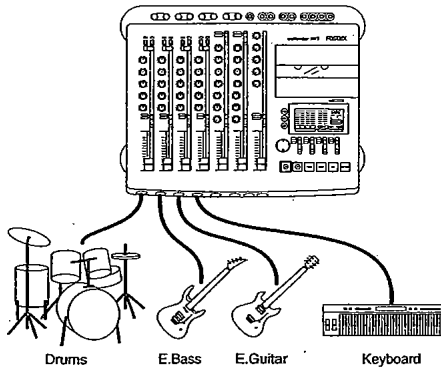

Direct recording

The XR-7 allows you to overdub four tracks one by one, and also to record four different sound sources on four tracks simultaneously. This is called "direct recording."

Recording a multitrack performance by yourself

If you are able to play more than one instrument, a multitrack recorder can be a very valuable music-making tool. For example, six channels carrying six different sounds can be routed to two tracks. If you are able to use MIDI instruments, you can use the tape sync function to create large orchestral arrangements. This manual will explain first how to record one sound source on a single track, and gradually move on to more complex possibilities.

Once you understand the basic principles, multitrack recording is quite simple and easy.

Using professional recording techniques

You may record a favorite song by your favorite professional musician, then record your own performance on a different track, accompanying the song. By using the pitch control to slow down the tape speed, you can more easily transcribe and learn how to play rapid phrases. You can also practice your part to your satisfaction using the instrument rehearsal mode (*) with a normal tape speed. If you make a few mistakes, these can be easily corrected using the punch in/out function with the rehearsal function. Try out these professional techniques.

(*) Refer to the Rehearsal button section on page 11 to learn how to switch the tape speed to normal speed. However, "Rehearsal" and "Pitch control" do not function when normal speed is selected.

Some important terms used in this manual

This section explains some of the important terms used in this manual, which you need to understand in order to take advantage of the XR-7.

Sound source

Instruments or microphones connected to the XR-7 are collectively called "sound sources."

Signal

The XR-7 is able to record not only sound from sound sources, but also FSK signals used by the tape sync function. Thus, sounds and signals are collectively explained as "input signals" or "output signals."

Overdubbing

The process of playing back a previously-recorded signal on one track while recording a different signal on another track is called "overdubbing."

On cassette radio players or stereo cassette decks, it is not possible to listen to the sound recorded on the left track while recording a new sound on the right track. However, the XR-7's overdubbing capabilities allow you to successively record new sounds on empty tracks.

Monitoring

As explained above, "overdubbing" includes the act of listening to a previously-recorded sound. This "listening to a previously-recorded sound" is often referred to as "monitoring." The word "monitor" means to check or verify, and in this manual's explanation of the recording process, listening to a previously-recorded track or checking the input signal to be newly recorded is referred to as "monitoring."

The difference between Tracks and Channels

Tracks and Channels are often confused. In this manual, they mean different things. Channels refer primarily to the input/output system of the mixer section. For example, this manual tells you that "the bass connected to channel 1" should be "output from the Left channel." Tracks, on the other hand, refer mainly to the recorder section (the tape). For example, this manual may tell you to "mixdown tracks 1, 2, 3, and 4." In other words, the XR-7 contains a four-channel mixer section and a four-track recorder section.

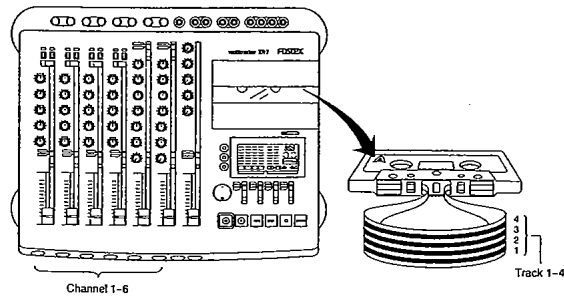

Input monitor and Tape monitor

"Monitoring the output from the recorder section" is often interpreted as "listening to the tape playback." However, to be precise, it has two meanings as follows:

Tape monitor:	Listening to the tape playback.
Input monitor:	Listening to each track signal that is directly output from the recorder section while recording or while in recording standby mode.

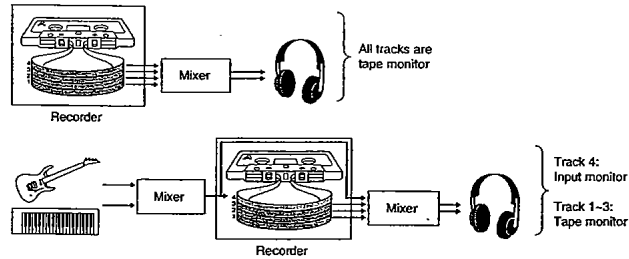

★ **Useful Tip 1 — About the [PAN] knobs and the stereo bus**

The XR-7 contains a six channel mixer. This means that you can mix six sound sources to stereo.

It is not possible to see from the outside how the signals flow. So, we have included a diagram below that explains the signal routing of the XR-7. The thick pipe in the diagram is called the stereo bus, and the signals from each [PAN] knob are collected here. After the [MASTER] fader makes the final level adjustment, the signals are output from the [STEREO OUT L] and [R] jacks.

The [PAN] knobs have the function of routing signals to the stereo bus. The output of the stereo bus is also sent to the recorder section. As shown in the diagram, the output of the L side is sent to tracks 1 and 3, and the output of the R side is sent to tracks 2 and 4. For example, if you wish to record the signals from all channels 1–6 on track 1, you should set the [REC SELECT] switch to “L”, and set the [PAN] knobs for all channels to the far “L” position.

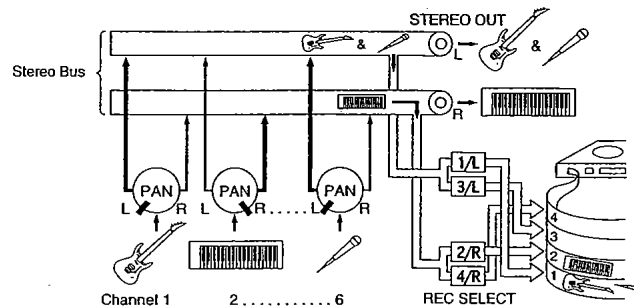

★ **Useful Tip 2 — About the [AUX] system**

The [AUX] (auxiliary) system is an auxiliary or supplementary input system. On the XR-7, however, it is used mainly for effect processing.

The [AUX] signals are provided in addition to the stereo bus explained in the preceding note. Since all channels 1–6 of the XR-7 can send to the [AUX] system, it is easy to perform effect processing. It is also possible to apply effect to foldback [FB] signals using the [AUX SEL] switch. So, you can apply effects to the tape signal during mixdown using tape sync(Post Foldback Send function).

★ **Useful Tip 3 — About foldback [FB]**

[FB] is used mainly to monitor the playback signal from the tape during overdubbing. The reason for using [FB] for monitoring is that the signal from [FB] is sent neither to the stereo bus nor to the recorder section. The [FB] signal is sent directly out the [FB] jack, and can be monitored but not recorded. This means that you can monitor the signal from a tape track without “using up” an input or allowing the monitored signal to get into the track you are newly recording. By setting the [MON SEL] switch to “ST+FB” or “FB”, you can monitor the [FB] signal through headphones or your monitor speaker. For details on using [FB], refer to STEP 3 and 4 “Overdubbing.”

About cassette tapes for the XR-7

Suitable types of cassette tape

The XR-7 is designed to use high-position cassette tapes (Chrome, type II), and will give the best performance when used with tapes such as Maxell XLII or TDK SA cassettes. We recommend that you use either these tapes or other tapes of equivalent quality. Since C-120 cassettes use thinner tape, they are not suitable for multitrack recording, where repeated recording and playback takes place. Avoid using anything longer than a C-90 with the XR-7.

Using the erase-protect tabs

Cassette tapes have "tabs" that can be broken off to prevent valuable recordings from being accidentally erased. Since the XR-7 uses all four tracks as a single side, break off the tabs for both side A and side B to prevent a completed recording from accidental erasure. If you later decide to record over the tape, you apply a piece of tape (duct tape or electrician's tape, etc.) over the broken-off tab holes so that the cassette can be re-recorded.

CHAPTER
2

Control panel and front and rear panels

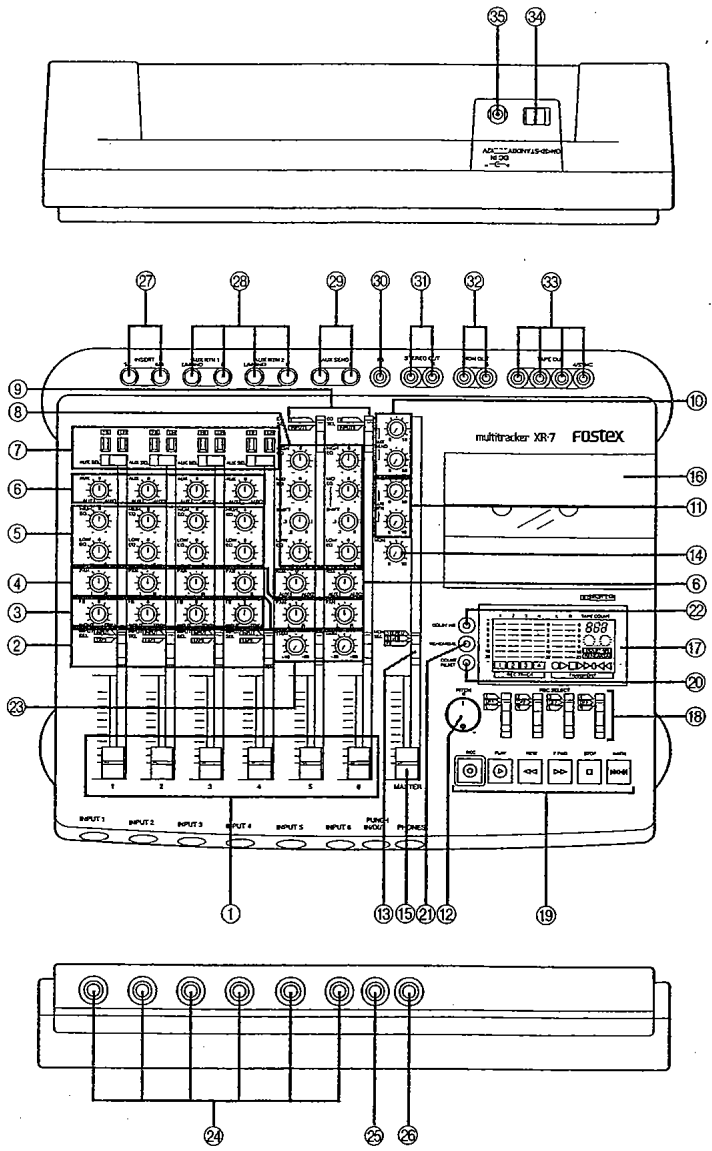

The words in square brackets [] refer to the printing on the front and rear panel.

Control panel

① Input faders [INPUT 1–6]

These faders adjust the level of the signals that are input from [INPUT] jacks 1–6.

② Input select switches [INPUT SEL]

These switches select the signal to be sent to the [INPUT] fader of each channel, then to the stereo bus.

INPUT:	The signal connected to the [INPUT] jacks 1–4 will be controlled by the [INPUT] fader.
TAPE:	The playback signal of the tape will be controlled by the [INPUT] fader. The signals of tracks 1–4 are routed to channels 1–4 respectively.

③ Foldback knobs [FB]

These knobs control the signal that is sent to the [FB] jack.

INPUT:	The input signal received at the [INPUT] jack will be sent to the [FB] jack without being affected by the [INPUT] fader.
TRK:	The tape playback signal (from tracks 1–4) will be sent to the [FB] jack.

④ Panpot knobs [PAN]

The panpot knobs have the following two functions.

- ① The panpot knobs are used to assign the sound sources connected to each [INPUT] jack to tracks 1–4. For this purpose, the panpot knobs are tuned either full right or full left.
- ② When playing back tracks 1–4 during mixdown etc., the panpot knobs are used to place each track in the desired position within the stereo image.

⑤ Shelving equalizer knobs [LOW/HIGH]

These knobs control the low frequency range (100Hz \pm 12dB) and high frequency range (10kHz \pm 12dB) of the input signal of each channel.

⑥ AUX send knobs [AUX]

The AUX send knobs determine the level of the input signal that will be sent to [AUX SEND 1] or [AUX SEND 2] jacks. The signal adjusted by these knobs and [AUX SEND] master knob can be sent to an external device, such as an effect unit.

AUX 1:	Send the signal to the [AUX SEND 1] jack.
AUX 2:	Send the signal to the [AUX SEND 2] jack.
0:	The signal is not sent to either output.

⑦ AUX send select switches [AUX SEL]

These switches select the signal to be sent to AUX send.

CH:	The signal from the [INPUT] fader will be sent to AUX send.
FB:	The signal from [FB] will be sent to AUX send.

⑧ Parametric equalizer knobs [LOW/MID/HIGH]

These knobs control the low frequency range (100Hz \pm 12dB), middle range (200Hz–5kHz \pm 12dB), and high frequency range (10kHz \pm 12dB) of either the channel 5, 6 signal, or the stereo bus L/R signal for fine tonal adjustment.

The [EQ SEL] switch determines which signal is affected by these knobs.

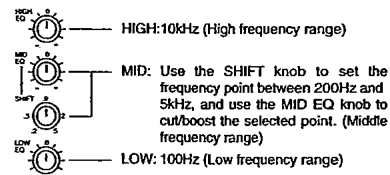

⑨ Equalizer select switches [EQ SEL]

This switch selects the signal that is controlled by the parametric equalizer.

INPUT 5, INPUT 6:	The signal input to [INPUT] jacks 5 and 6 will be controlled by the equalizer.
L, R:	The stereo bus L/R signal will be controlled by the equalizer.

⑩ **AUX send master level knobs [AUX SEND 1] [AUX SEND 2]**

These knobs adjust the level of the mix signal after the channel [AUX] send knobs, before it is sent to the external effect unit via [AUX SEND 1] and [AUX SEND 2].

Note:

If these knobs are set to 0, no signal is sent to the effect unit even if the channel [AUX] send knobs are raised.

⑪ **AUX return 1, 2 knobs [AUX RTN 1] [AUX RTN 2]**

These knobs control the signal sent to the stereo bus L/R from external devices (such as effect units) connected to the [AUX RTN 1] and [AUX RTN 2] jacks. That is, the signal processed by the effect unit is sent to the stereo bus L/R.

⑫ **Pitch control knob [PITCH]**

This knob allows you to adjust the tape speed within a range of $\pm 10\%$. When the knob is in the center position ("0"), the tape speed will be high (9.5cm/s). This control does not function when the normal speed (4.75cm/s) is selected.

⑬ **Monitor select switch [MON SEL]**

This switch selects the signal to monitor through the headphones or monitor speakers.

STEREO:	The signal that is output from the [STEREO OUT L] and [R] jacks will be monitored.
ST+FB:	The signals from [STEREO OUT L] and [R] jacks and from the [FB] jack will be monitored together.
FB:	The signal from the [FB] jack will be monitored.

⑭ **Monitor level knob [MON]**

This knob controls the volume of the external monitor or headphones.

⑮ **Master fader [MASTER]**

This fader controls the signal that is output from [STEREO OUT L] and [R]. This is also used to control the output level or recording level for tracks during mixdown.

⑯ **Deck transport**

This is where the cassette tape is inserted. When you install a cassette tape, the transport indicator [c] lights up.

⑰ **Operation indicator**

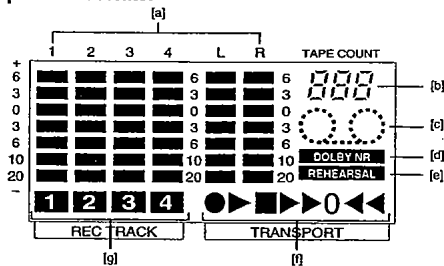

[a]: Bargraph level meters

Track level 1-4: These meters indicate the level of each track input signal, and playback signal. Stereo bus L, R: These meters indicate the level of STEREO OUT L and R, and stereo bus output signal.

[b]: Tape counter [TAPE COUNT]

This displays the tape location. To reset the counter to [000], press the [COUNT RESET] key.

[c]: Tape transport indicator

This indicator lights up when you insert a cassette tape, indicating the transport status (direction/speed/stop).

[d]: Dolby C NR indicator

This indicator lights up when you press the [DOLBY NR] switch to turn the Dolby C noise reduction system ON.

[e]: Rehearsal indicator

This indicator lights up when you press the [REHEARSAL] button to turn rehearsal mode ON.

[f]: Transport indicator

STOP = ■

PLAY = ►

F FWD = ►►

REWIND = ◀◀

REC= ● (flashing: recording stand-by, lit: recording)

0 RTN= ►►0 or 0◀◀

[g]: Record track indicators

These indicators display the recording status of tracks 1-4.

Flashing=recording stand-by

Lit=recording

The indicator of the track for which the [REC SELECT] switch is ON will flash.

Pressing the [PLAY] button while holding down the [REC] button will change the indicator from flashing to lit, indicating that recording mode is entered.

⑱ Record track select switches [REC SELECT]

These switches select the track(s) that will be recorded.

If these are set to "OFF", the signal will not be recorded on any track.

Select "1-4" to make direct recording of the instruments connected to [INPUT] jacks 1-4. Select "L, R" if you are recording the signal output from the stereo bus L and R. Tracks 1 and 3 will record the stereo bus L signal, and tracks 2 and 4 will record the stereo bus R signal.

⑲ Transport control buttons

● Record button [REC]

Pressing only this button will allow you to monitor the signal input to the track for which the [REC SELECT] switch is ON. Pressing this button repeatedly will turn this input monitor ON/OFF. (When the input monitor is ON, the REC indicator flashes.)

Pressing the [PLAY] button while holding down this button will allow you to start recording. (If all the REC SELECT switches are set to OFF, you cannot enter recording mode.)

Note:

Turning the [REC SELECT] switch OFF during input monitoring will cancel the input monitor. Turning the [REC SELECT] switch ON again will not turn the input monitor on. In this case, press the [REC] button ON again.

● Play button [PLAY]

● Rewind button [REW]

● Fast-forward button [F FWD]

● Stop button [STOP]

● 0 return button [0 RTN]

Pressing this button will advance the tape to the "000" position, or rewind the tape and stop. Pressing the [PLAY] button during the fast-forward or rewind operation will cause the [PLAY] indicator (►) to flash, and automatic playback will start from the "000" position.

⑳ Counter reset button [COUNT RESET]

Pressing this button will reset the tape counter to "000."

㉑ Rehearsal mode button [REHEARSAL]

This button switches rehearsal mode ON/OFF.

When rehearsal mode is ON and the footswitch is connected to the XR-7, you can repeatedly rehearse parts using the footswitch without actually punching in, (more clear, without recording). When rehearsal mode is ON, the display [REHEARSAL] indicator lights up. (For detail, refer to STEP 6 "Punch-in/out.")

Pressing this button and the [STOP] button simultaneously while tape transport is stopped will switch the tape speed from high speed to normal speed. (The [REHEARSAL] indication the display will flash.)

Press this button again to switch back to high speed.

Note:

Rehearsal mode is effective only when high speed is selected; it does not function when normal speed is selected.

⑳ **Dolby C noise reduction switch [DOLBY NR]**

This switch turns Dolby C noise reduction ON or OFF.
To enjoy recording and playing back high-quality sound, set this switch to the ON position.
When Dolby C NR is on, the [DOLBY NR] indicator on the display lights up.

㉑ **Input trim knobs [TRIM]**

This knob is used to adjust the signal level according to the output level of the sound sources connected to [INPUT] jacks 5 and 6.
Turn this knob toward $-60(\text{dBV})$ when a low-level instrument such as a microphone is connected, and turn this toward $-10(\text{dBV})$ when a high-level instrument such as an electronic instrument is connected.

Front panel input/output jacks

㉒ **Input jacks [INPUT 1–6]**

Sound sources you wish to input can be connected to these jacks.
[INPUT] jacks 1–4 are able to accept only line signals such as electronic instruments, and [INPUT] jacks 5 and 6 are able to accept either line or mic signals.

㉓ **Punch in/out jack [PUNCH IN/OUT]**

When using the punch in/out function, connect a Fostex 8051 footswitch (sold separately) to this jack.

㉔ **Headphone jack [PHONES]**

A set of headphones can be connected to this jack for monitoring. Use the [MON] knob to adjust the headphone level.

Rear panel input/output jacks

㉕ **Insert jacks [INSERT 5/L, 6/R]**

These jacks can be used when you wish to do independent effect processing of the signals that are input into channels 5 and 6, or of the mix signals on the stereo bus L and R (Use the [EQ SEL] switch to select a signal).

This capability is especially convenient when you are inputting an acoustic instrument or microphone to channel 5 or 6, and wish to process it with a compressor or effect unit. Use a cable as shown in the following diagram.

㉖ **AUX return 1, 2 jacks [AUX RTN 1][AUX RTN 2]**

The signal processed by effect units can be input to these line-level (-20dBV) jacks to route to the stereo bus L and R. If you are using an effect unit that has a mono output, connect it to the [L/MONO] jack.

㉗ **AUX send 1, 2 jacks [AUX SEND 1][AUX SEND 2]**

The output signal from these jacks can be sent to an effect unit, etc.
Connect these jacks to the input jacks of your effect unit or other device.
The level of mixed signal adjusted by [AUX] send knobs 1–6 will subsequently be controlled by the [AUX SEND] master knob.

㉘ **Foldback jack [FB]**

This jack outputs the signal controlled by the [FB] jack.
This jack can output the input signal unaffected by the [INPUT] faders, or it can output the playback signal from the tape. The [FB] knob determines which signal is output. Foldback is used primarily to provide a monitor sound for the musicians.

㉙ **Stereo out jacks [STEREO OUT L, R]**

These jacks output the stereo L and R signals.
During mixdown, connect these jacks to the inputs of your master recorder.

㉚ **Monitor out jacks [MON OUT L, R]**

These jacks output the monitor signal that is selected by the [MON SEL] switch. Connect these jacks to your monitor amp/speaker system, etc.

③③ **Tape out jacks [TAPE OUT 1-4/SYNC]**

These jacks output the signals from tape tracks 1-4.

Use these jacks when you wish to use an external mixer, or for effect processing. Jack 4 can also be used as a [SYNC OUT] jack to transmit a synchronization signal to a MIDI sequencer, etc.

③④ **Power switch [POWER ON/STANDBY]**

This switch turns the XR-7's power on or off (standby).

Note:

When the AC adaptor is connected to an outlet, it will continue drawing a small amount of AC power even if you turn the power switch off (STANDBY). If you will not be using the XR-7 for a while, be sure to disconnect the AC adaptor from the outlet.

③⑤ **AC adaptor connector [DC IN --- 12V]**

Connect the included AC adaptor to this connector.

Be sure to use the AC adaptor that comes in the package with the XR-7.

Preparation

Key points of operation and settings

This manual explains the basic operation of the XR-7 in a sequence from STEP 1 to STEP 8. This chapter explains important points and tips for XR-7 operation, such as connection of sound sources (instruments and microphones), connection of effect units, switch and knob controls, adjustment of input signal level.

Connecting the sound sources

Using the [INPUT SEL] switches

[REC SELECT] switch [PAN] knob settings

How to monitor the signal

[MON SEL] switch settings

Adjusting the input signal

Equalizer settings (Tonal adjustment)

Using AUX send/return for effect processing

[FB] knob settings

Using the Insert jack

Connecting the sound sources

The [INPUT] jacks to which you connect the sound sources differ depending on the step. Connect the sources correctly following the instructions in each step.

You can connect up to six sound sources to the XR-7. Take special note that you can adjust the level using the TRIM knobs for the sound sources connected to the [INPUT] jacks 5 and 6, which allows you to connect either mic level or line level instruments.

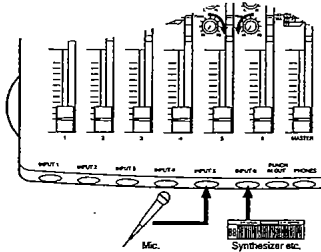

Using the [TRIM] knobs:

You can adjust the level of the signal input to the [INPUT] jacks 5 and 6 according to the output level of the connected sound sources. We recommend you connect the microphone to the [INPUT] jack 5 or 6 and adjust the level using the TRIM knobs as follows:

When a low-level source such as a microphone is connected:

Rotate the knob clockwise (toward “+60”).

When a line-level source such as a synthesizer is connected:

Rotate the knob counter-clockwise (toward “-10”).

Using the [INPUT SEL] switches

Set the [INPUT SEL] switches as follows according to the signal routed to the [INPUT] faders. The signal adjusted by the [INPUT] fader goes from the [INPUT] fader through [EQ] and [PAN], to the stereo bus. (However, in direct recording, the signal is routed directly to the recording section from the [EQ] section, and it is not sent to the stereo bus.)

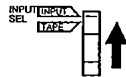

“INPUT”: The signal input from the [INPUT] jacks is controlled. This setting is usually used to record the sound source connected to the corresponding [INPUT] jack.



“TAPE”: The tape playback signal is controlled. This setting is usually used to adjust each track signal and record to a master recorder.

[REC SELECT] switch [PAN] knob settings

[REC SELECT] switch settings

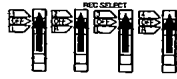

"1, 2, 3, 4"

Use this setting when you are recording the [INPUT] jack 1-4 signal directly to tracks 1-4.



"L, R"

Use this setting when you are recording the signal to tracks 1-4 via the stereo bus. Stereo bus L signal is recorded to track 1 or 3, and stereo bus R signal is recorded to track 2 or 4. Use the [PAN] knobs to route the signal to each track.

[PAN] knob settings



Rotate the knob far left to send the signal to the stereo bus L.



Rotate the knob far right to send the signal to the stereo bus R.

Basically, the [PAN] knobs are used to route the input signal to stereo bus L (track 1 and 3) and stereo bus R (track 2 and 4).

Rotate the knobs far left or far right to send the input signal to stereo bus L or R, respectively.



Adjust the stereo image as you wish.

During mixdown, use the [PAN] knobs to determine the stereo image of the tape playback signal routed to channels 1-4. In direct recording, use these knobs only to adjust the stereo image of the monitoring signal.

Relationship between the [PAN] knobs and [REC SELECT] switches

Usually, the channel signal via stereo bus is routed by the [PAN] knob and [REC SELECT] switch settings to the tape.

The following table shows the relationship between the [PAN] knobs and [REC SELECT] switches:

	PAN knobs	REC SELECT switches
Direct recording of channel 1-4 signal to tracks 1-4	It is not affected by the PAN settings Channel 1-4	
Recording the input channel 1-4 signal to track 1	 Channel 1-4	
Recording the channel 1-3 signal to track 3, and channel 4-6 signal to track 4	 Channel 1-6	

How to monitor the signal

To monitor the signal, connect your headphones to the [PHONES] jack; or connect an amp with a built-in speaker or a power amp/speaker combination to the [MON OUT] jack. To adjust the monitoring level, raise the [MASTER] fader and rotate the [MON] knob.

[MON SEL] switch settings

Select one of the following settings according to the type of monitor signal:

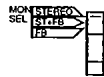

"STEREO"

Use this setting most of the time. You can monitor only the stereo bus L/R signal.

"ST+FB"

This setting allows you to monitor the mix of the stereo bus signal and the [FB] signal. For example, during overdubbing, you can monitor the tape playback signal and recording signal simultaneously.

"FB"

You can monitor only the [FB] signal.

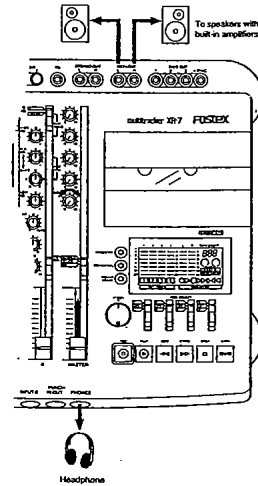

Adjusting the input signal

You need to obtain an appropriate recording level before you start recording. It is important to set the recording track to input monitor in order to adjust the input signal as follows:

Select a recording track.



Press the [REC] button to set the recording track to input monitor.



Raise the [MASTER] fader to about 7 or 8.



Raise the [INPUT] fader gradually while playing the instrument, and check the level meter. (For INPUTs 5 and 6, raise the [INPUT] faders to 7 or 8 and adjust the [TRIM] knob.)

Equalizer settings (Tonal adjustment)

The XR-7 has two types of equalizer: shelving and parametric. They have the following functions:

Shelving equalizer

This allows you to equalize only channel 1-4 signal, controlling the low frequency range of 100Hz \pm 12dB, and high range of 10kHz \pm 12dB.

Parametric equalizer (Assignable Parametric EQ function)

This equalizer is used to equalize the channel 5 and 6 signal, or the stereo bus L and R. Use the [EQ SEL] switch to determine which signal is controlled.

The parametric equalizer allows for a fine equalizing of the middle frequency range of 200Hz - 5kHz, in addition to the low and high frequency ranges. Connect the sound source for a subtle tonal adjustment to the [INPUT] jacks 5 and 6.

Since in multitrack recording the sounds can be layered and re-recorded many times, the high frequencies may eventually begin sounding dull. For this reason it is a good idea to boost the high frequencies a bit when recording.

Using AUX send/return for effect processing

Connecting an effect unit

You will need to use the AUX send/return function to route the signal to an effect processor such as a reverb unit.

The XR-7 has two pairs of AUX sends (mono output) and AUX returns (stereo input), allowing you to connect two effect processors.

Refer to the diagram when connecting effect units to the XR-7.

If you are using an effect unit that has a mono output, connect it to the "L/MONO" jack of the [AUX RTN 1] and [AUX RTN 2] jacks. (Connecting the unit to the L/MONO jack automatically causes the identical signal to be sent to the R bus.)

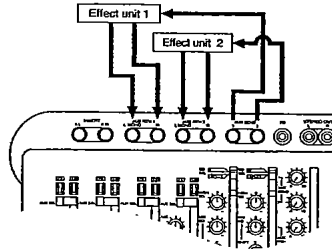

Note on multitrack recording using the stereo bus (refer to STEP 2):

When you are using two effect processors that both have only mono outputs for multitrack recording using the stereo bus, remember the following when making connections:

To send a mono signal from each effect unit to the stereo bus L and R, connect a dummy plug to the [AUX RTN] jack R of the stereo bus L. Otherwise, the signal input at the L/MONO jack will also be routed to the stereo bus R.

[AUX SEL] switch settings

This switch is used to select signals for effect processing.



"CH"

Use this setting to apply effects to the [INPUT] fader signal.



"FB"

Use this setting to apply effects to the [FB] signal (Post Foldback Send function). For example, select this option when you wish to apply effects to the tape signal during a tape sync mixdown. (Refer to STEP 8 for detailed procedure.)

[AUX] send, [AUX SEND] master, and [AUX RTN] knob settings

The signal is sent to the connected effect processor and back to the XR-7 via each knob as shown in the diagram below. Remember that applying an effect to a signal requires adjustment of three types of knobs.

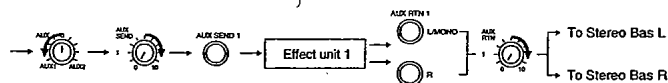

[FB] knob settings

The signal sent to [FB] is not routed to the recorder section, but output to the [FB] jack. These knobs are mainly used to control the tape monitor signal during overdubbing, or to send the monitoring signal to the players.

Adjusting the knobs as shown in the diagram below will send either signal to [FB].



Rotating the knob counter-clockwise (toward the "INPUT" side) will send the [INPUT] jack signal to [FB].



Rotating the knob clockwise (toward the "TRK" side) will send the tape playback signal to [FB].

Using the Insert jack

Use a cable as shown below to connect your effect processor to the Insert jack.

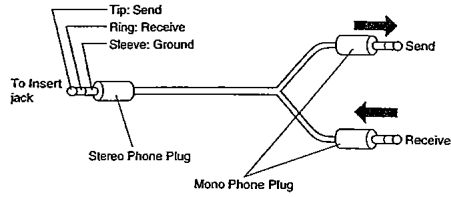

e.x.: When you wish to apply effects only to the sound source connected to [INPUT] jack 5

Use an effect unit that has a mono input/mono output.
Set the [EQ SEL] switch of channel 5 to "INPUT 5."
Adjust the signal level on the effect unit.

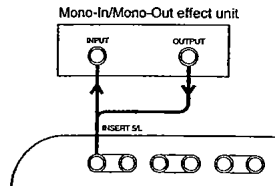

e.x.: When you wish to apply an effect separately to stereo bus L and R

Use an effect unit that has a stereo input/stereo output.
Set the [EQ SEL] switch to "L", and "R."
Adjust the signal level on the effect unit.

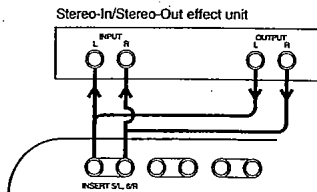

Basic Operation (Start Recording)

One step at a time

By now you should understand the function of each knob and switch on the XR-7. This chapter and following chapter explain the operation of the XR-7 in eight steps. In this manual, STEPS 1–5 explain the XR-7's basic functions. STEPS 6–8 explain somewhat more advanced techniques.

Once you have mastered STEPS 1–8, you can go ahead and develop your own recording methods.

- STEP 1: Direct recording
- STEP 2: Record six sound sources on track 1 and 2
- STEP 3: Overdubbing - 1
- STEP 4: Overdubbing - 2
- STEP 5: Mixdown
- STEP 6: Punch in/out
- STEP 7: Ping-pong recording
- STEP 8: Orchestration using tape sync (MIDI/TAPE Multi-mix function)

Initial settings on the XR-7

After completing a step, you should reset the sliders and switches before proceeding to the next step. Resetting the knobs and switches that were used in a previous step will prevent mistakes (such as erasing a recorded track) that may result from inappropriate settings. The process of setting the controls to the positions given in the following list is referred to in this manual as "initializing."

Remember to initialize the controls before beginning each step.

How to initialize the controls

- * Lower the [INPUT] faders for all channels and the [MASTER] fader.
- * Set all knobs to "0." (Set the [PAN] knobs to the center position and set the [AUX SEND] master and [AUX RTN] knob to the minimum value.)
- * Set the [INPUT SEL] switches of channels 1–4 to "INPUT."
- * Set the [AUX SEL] switch of channels 1–4 to "CH."
- * Set each of the [REC SELECT] switches to "OFF."
- * Set the [EQ SEL] switches of channels 5 and 6 to "INPUT 5" and "INPUT 6" respectively.
- * Set the Dolby C NR switch to "OFF."
- * Set the [REHEARSAL] button to "OFF."

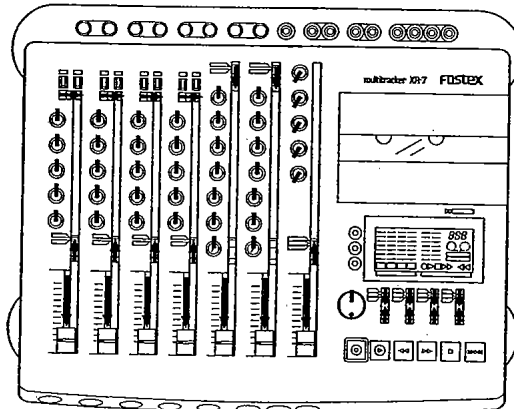

STEP 1: Direct Recording

In STEP 1, we will explain how to record four different sound sources to four tracks simultaneously using a direct recording technique. You can also record one sound source to track 1, then record a second sound source to track 2 while monitoring the recorded data on track 2. This overdubbing technique is explained in STEP 3 and 4.

What is direct recording?

In direct recording, the input signal is sent directly to the recorder section.

Use of the [REC SELECT] switch is different from that in normal multitrack recording. This technique is very useful in recording channel 1-4 input signals to four tracks simultaneously, such as the recording of a four-piece band (drums, bass, keyboard, and guitar, etc.).

The example here has the following relationship between the input sound sources and recording tracks:

Channel 1 input signal (drums)	→	Track 1
Channel 2 input signal (bass guitar)	→	Track 2
Channel 3 input signal (guitar)	→	Track 3
Channel 4 input signal (keyboard)	→	Track 4

Preparation and tips

- ☆ Turn the power on to the XR-7.
- ☆ Before you begin, initialize the controls of the XR-7.
- ☆ Insert the tape and rewind it to the location at which you want to begin recording.

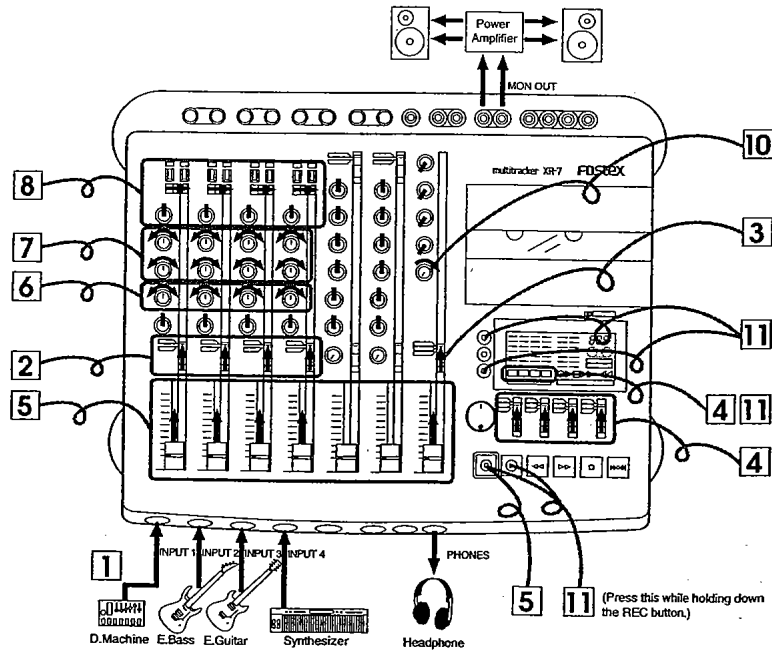

-
- 1 Connect the sound sources.**
 - Connect the sound sources to the [INPUT] jacks 1–4.

- 2 [INPUT SEL] switch settings**
 - Set the channels 1–4 [INPUT SEL] switches to “INPUT.”

- 3 [MON SEL] switch settings**
 - Set the switch to “STEREO.”

- 4 [REC SELECT] switch settings**

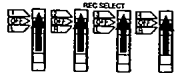

The track 1–4 [REC TRACK] indicators **1 2 3 4** will flash.

- 5 Adjusting the input signal**
 - Press the [REC] button to turn the input monitor on. (The [REC] indicator will flash.)
 - Raise the [MASTER] fader to about 7 or 8.
 - While playing all four instruments simultaneously, gradually raise the channel [INPUT] faders until the level meter moves to an appropriate level.

- 6 [PAN] knob settings**
 - The [PAN] knobs do not affect any signal in direct recording. However, you can adjust the pan position in the stereo image of the monitoring signal.

- 7 Equalizer settings**
 - Use the equalizer knobs to adjust the tone of each input signal.

- 8 AUX settings**
 - You will not use the [AUX] send/return knobs in direct recording.
 - Set the [AUX SEL] switches to “CH”, [AUX] send knobs to “0”, and [AUX SEND] master knobs to minimum.

- 9 [FB] knob settings**
 - You will not use the [FB] knobs in direct recording. Set these switches to the center position.

- 10 Adjusting the monitor level**
 - Rotate the [MON] knob gradually, and you will hear the monitor sound.

- 11 Start recording.**
 - Press the [COUNT RESET] button to reset the counter to [000].
 - Press the [DOLBY NR] switch to turn Dolby C noise reduction on.
 - After adjusting the input signal, press the [PLAY] button while holding down the [REC] button to start recording. (The [REC] and [REC TRACK] indicators become lit.)
 - When you finish recording, press the [STOP] button and the tape will stop.

- 12 Playback**
 - Press the [O RTN] button to rewind the tape.
 - Set all the [REC SELECT] switches to OFF.
 - Change the channel 1–4 [INPUT SEL] switch settings from “INPUT” to “TAPE.”
 - Press the [PLAY] button to start playback.
 - Use the channel 1–4 [INPUT] faders to adjust the level of tracks 1–4 signal.
 - Refer to “STEP 5” for information on mixing down to your master recorder.

STEP 2: Recording Six Sound Sources to Track 1 and 2 (Multitrack Recording Using the Stereo Bus)

STEP 2 explains how to record six sound sources on two tracks via the stereo bus. Here, you will use the [REC SELECT] switch in a different manner from direct recording. In this example, the six sound sources will be recorded on two tracks as shown below.

Sound sources A, B, C, and D → Track 1
 Sound sources E and F → Track 2

Preparation and tips

- ☆ Before you begin, initialize the controls of the XR-7.
- ☆ Insert the tape you wish to record on, and rewind it to the location at which you want to begin recording.
- ☆ In this example, different effects are applied to sound sources A/B, and sound sources E/F.

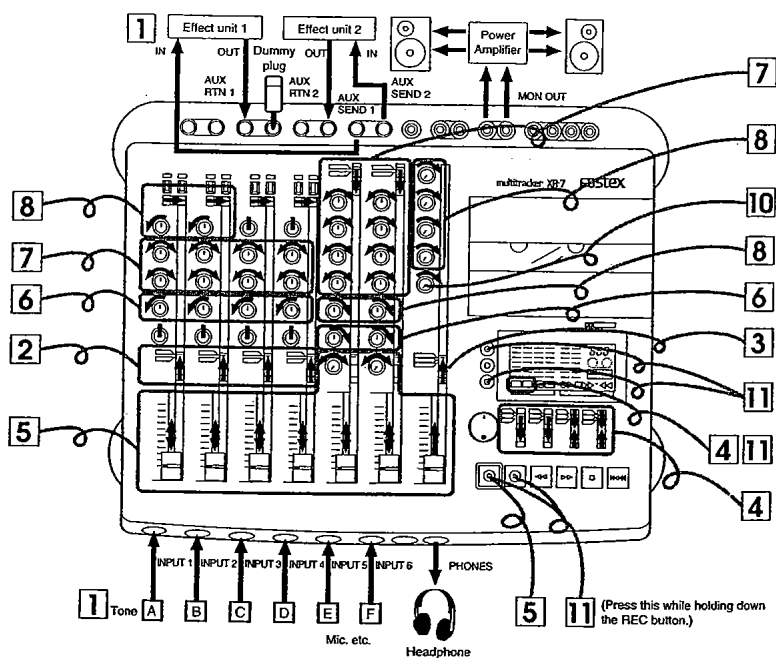

1 Connect the sound sources and the effect unit.

- Connect the six sound sources (A, B, C, D, E, F) to the [INPUT] jacks 1–6.
- It is recommended to connect low-output sound sources such as a microphone to [INPUT] jacks 5 and 6, and use the [TRIM] knob, if necessary, to adjust the level.
- Connect effect unit 1 to the L/MONO jack of [AUX SEND 1] and [AUX RTN 1]. (Insert a dummy plug to the R jack.)
- Connect effect unit 2 to the R jack of [AUX SEND 2] and [AUX RTN 2].

2 [INPUT SEL] switch settings

- Set the channel 1–4 [INPUT SEL] switches to "INPUT."

3 [MON SEL] switch settings

- Set the switch to "STEREO."

4 [REC SELECT] switch settings



The track 1, 2 [REC TRACK] indicators **1 2** will flash.

5 Adjusting the input signal

- Press the [REC] button to set tracks 1 and 2 to input monitor. (The [REC] indicator will flash.)
- While playing each instrument, gradually raise the channel [INPUT] faders until the level meter is moving at an appropriate level.

6 [PAN] knob settings

- Turn the channel 1–4 [PAN] knobs far left.
- Turn the channel 5, 6 [PAN] knobs far right.

7 Equalizer settings

- Use the shelving equalizer to adjust the tone of the input channel 1–4 signal.
- For channels 5 and 6, set the [EQ SEL] switches to "INPUT 5" and "INPUT 6" respectively. Then use the parametric equalizer to adjust the tone.

8 AUX settings

- Set the channel 1 and 2 [AUX SEL] switches to "CH."
- Gradually rotate the channel 1 and 2 [AUX] send knobs toward the "AUX 1" side, and adjust the entire level using the [AUX SEND 1] master knob.
- Gradually rotate the channel 5 and 6 [AUX] send knobs toward the "AUX 2" side, and adjust the entire level using the [AUX SEND 2] master knob.
- Adjust the effect return signal level using the [AUX RTN 1] and [AUX RTN 2] knobs.

9 [FB] knob settings

- You will not use the [FB] knobs in this step.

10 Adjusting the monitor level

- Rotate the [MON] knob gradually to adjust the monitor level.

11 Start recording.

- Press the [COUNT RESET] button to reset the counter to [000].
- Press the [DOLBY NR] switch to turn Dolby C noise reduction on.
- After adjusting the input signal, press the [PLAY] button while holding down the [REC] button to start recording. (The [REC] and [REC TRACK] indicators become lit.)
- When you finish recording, press the [STOP] button and the tape will stop.

12 Playback

- Press the [0 RTN] button to rewind the tape.
- Set all the [REC SELECT] switches to OFF.
- Change the channel 1 and 2 [INPUT SEL] switch settings from "INPUT" to "TAPE."
- Press the [PLAY] button to play back the recorded tracks 1 and 2.
- Use the channel 1 and 2 [INPUT] faders to adjust the level of tracks 1 and 2.
- Use the [PAN] knobs to adjust the stereo image of tracks 1 and 2.

STEP 3: Overdubbing – 1

In STEP 3, we will explain how to overdub track 1 and 2 signals to track 3 while monitoring the signal. STEP 4 explains how to overdub track 1–3 signals to track 4 while monitoring the signal.

In this example, we will overdub a new sound source to track 3 while monitoring track 1 and 2 signals that have already been recorded in STEP 2.

Each sound source is recorded to a track as shown below.

- Sound sources A, B, C, and D → Track 1 (already recorded)
- Sound sources E and F → Track 2 (already recorded)
- New sound sources G and H → Track 3

What is overdubbing?

As explained on page 4, overdubbing is the process of recording a new sound source on a track while you monitor the signal of a different, previously recorded track.

Preparation and tips

- ☆ Before you begin, initialize the controls of the XR-7.
- ☆ Insert the tape you wish to record on, and rewind it to the location at which you want to begin recording.
- ☆ To monitor the playback signal, it will be routed to the [FB].
- ☆ In this example, effect unit 1 applies an effect to sound source G and effect unit 2 applies an effect to sound source H.

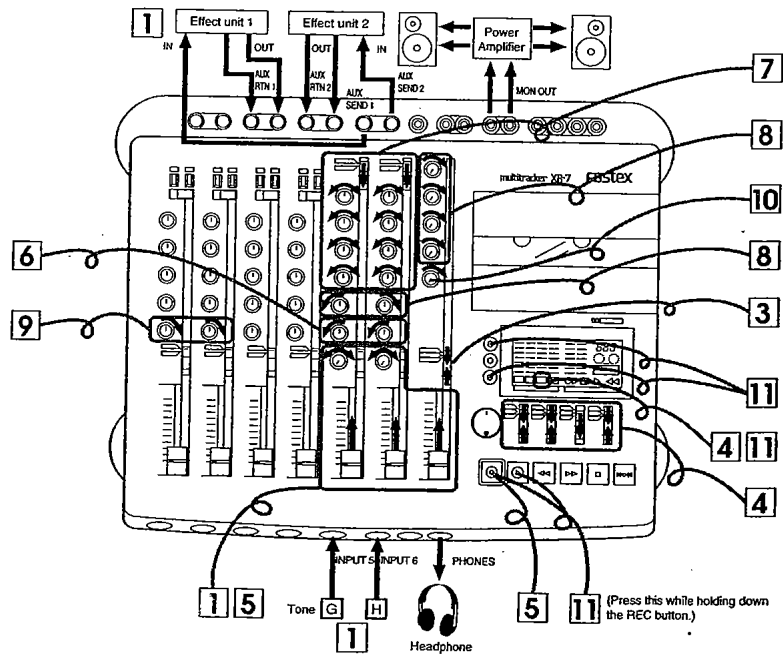
**1 Connect the sound sources and the effect unit.**

- Connect new sound sources (G and H) to [INPUT] jacks 5 and 6.
- Use the [TRIM] knob according to the input level of the connected sound source.
- Connect effect unit 1 to the [AUX SEND 1] and [AUX RTN 1] jacks, and connect effect unit 2 to the [AUX SEND 2] and [AUX RTN 2] jacks.

2 [INPUT SEL] switch settings

- You do not need to set the [INPUT SEL] switches.

3 [MON SEL] switch settings

- Set the switch to "ST+FB."

4 [REC SELECT] switch settings



The track 3 [REC TRACK] indicator **3** will flash.

5 Adjusting the input signal

- Raise the [MASTER] faders to about 7 or 8.
- Press the [REC] button to set tracks 3 to input monitor. (The [REC] indicator will flash.)
- While playing each sound source, gradually raise the channel 5 and 6 [INPUT] faders until the level meters moves to an appropriate level.

6 [PAN] knob settings

- Turn the channel 5 and 6 [PAN] knobs far left.

7 Equalizer settings

- For channels 5 and 6, set the [EQ SEL] switches to "INPUT 5" and "INPUT 6" respectively. Then use the equalizer to adjust the tone.

8 AUX settings

- To adjust the amount of effect, rotate the channel 5 [AUX] send knobs toward the "AUX 1" side, and gradually rotate the channel 6 send knobs toward the "AUX 2" side, then adjust the entire level using the [AUX SEND 1] and [AUX SEND 2] master knobs.
- Adjust the effect return signal level using the [AUX RTN 1] and [AUX RTN 2] knobs.

9 [FB] knob settings

- Gradually rotate the channel 1 and 2 [FB] knobs toward "TRK." You will hear track 1 and 2 playback signal through the monitor speaker.

10 Adjusting the monitoring level

- Rotate the [MON] knob gradually to adjust the monitoring level. The track 1 and 2 signal is positioned at center, and the signals of sound sources G and H are positioned on the left in the stereo image.

11 Start recording

- Press the [COUNT RESET] button to reset the counter to [000].
- Press the [DOLBY NR] switch to turn Dolby C noise reduction on.
- After adjusting the input signal, press the [PLAY] button while holding down the [REC] button to start recording.
- When recording starts, the signal from tracks 1 and 2 (sound sources A-F) will be heard at the level determined by the [FB] knob setting. Play along with the signal from tracks 1 and 2.
- From time to time, check that the level meter is not going all the way to the top.
- When you finish recording, press the [STOP] button.

12 Playback

- Press the [0 RTN] button to rewind the tape to [000].
- Change the channel 1-3 [INPUT SEL] switch settings from "INPUT" to "TAPE."
- Press the [PLAY] button to play back the tape.
- Use the channel 1-3 [INPUT] faders to adjust the level of tracks 1-3.
- Use the channel 1-3 [PAN] knobs to change the stereo image.

STEP 4: Overdubbing – 2

In STEP 3, we have recorded new sound sources on track 3 while monitoring the signal from tracks 1 and 2. In STEP 4, we will record four sound sources on track 4 while monitoring the signals from tracks 1, 2, and 3.

Each sound source is recorded on a track as follows:

- Sound sources A, B, C, and D → Track 1 (already recorded)
- Sound sources E and F → Track 2 (already recorded)
- Sound sources G and H → Track 3 (already recorded)
- New sound sources I, J, K, and L → Track 4

Preparation and tips

- ☆ Before you begin, initialize the controls of the XR-7.
- ☆ Insert the tape and rewind it to the location at which you want to begin recording.
- ☆ To monitor the playback signal, it will be routed to the [FB].
- ☆ In this example, effect unit 1 applies an effect to sound sources I and J.

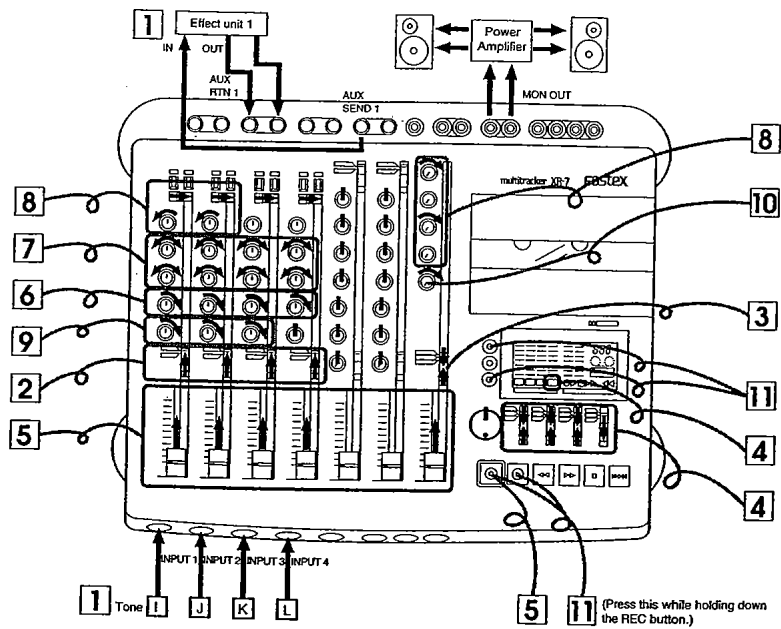

- 1 Connect new sound sources**
 - Connect new sound sources (I, J, K, L) to the [INPUT] jacks 1–4.
- 2 [INPUT SEL] switch settings**
 - Set the channel 1–4 [INPUT SEL] switches to "INPUT."
- 3 [MON SEL] switch settings**
 - Set the switch to "ST+FB."

4 [REC SELECT] switch settings



The track 4 [REC TRACK] indicator **4** will flash.

5 Adjusting the input signal

- Raise the [MASTER] faders to about 7 or 8.
- Press the [REC] button to set track 4 to input monitor.
- While playing each sound source, gradually raise the channel [INPUT] faders until the level meters are moving at an appropriate level.

6 [PAN] knob settings

- Turn the channel 1–4 [PAN] knobs far right.

7 Equalizer settings

- Use the channel 1–4 shelving equalizers to adjust the tone.

8 AUX settings

- Turn the channel 1 and 2 [AUX] send knobs toward "AUX1" and use the [AUX SEND 1] master knob to adjust the amount of the effect.
- Use the [AUX RTN 1] knob to adjust the amount of the signal sent from the effect unit to the stereo bus R.

9 [FB] knob settings

- Gradually rotate the channel 1, 2 and 3 [FB] knobs toward "TRK." You can monitor the track 1, 2 and 3 playback signal.

10 Adjusting the monitoring level

- Rotate the [MON] knob gradually to adjust the monitoring level. The track 1, 2 and 3 signals are positioned at center, and the signals of sound sources I, J, K, and L are positioned on the right in the stereo image.

11 Start recording

- Press the [COUNT RESET] button to reset the counter to [000].
- Press the [DOLBY NR] switch to turn Dolby C noise reduction on.
- After adjusting the input signal, press the [PLAY] button while holding down the [REC] button to start recording.
- When recording starts, the signal from tracks 1, 2 and 3 will be heard at the level determined by the [FB] knob setting. Play along with the signal from tracks 1 and 2.
- From time to time, check that the level meter is not going all the way to the top.
- When you finish recording, press the [STOP] button.

12 Playback

- Press the [0 RTN] button to rewind the tape to [000].
- Change the channel 1–4 [INPUT SEL] switch settings from "INPUT" to "TAPE."
- Press the [PLAY] button to play back the tape.
- Use the channel 1, 2, 3, and 4 [INPUT] faders to adjust the level of tracks 1, 2, 3, and 4.
- Use the channel 1–4 [PAN] knobs to change the stereo image.

STEP 5: Mixdown

STEP 5 explains how to mix down the signals from tracks 1–4 that you overdubbed in STEPS 2–4 to a master recorder.

Mixdown allows you to make fine adjustments to the level of each track, and add effect processing to create a finished sound.

What is mixdown?

Mixdown refers to the process of playing back the signals recorded on two or more tracks, combining these to a stereo or mono signal, and recording the result on a separate master tape. This is the final step in creating a multitrack recording.

Preparation and tips

- ☆ Before you begin, initialize the controls of the XR-7.
- ☆ Insert the tape and rewind it to the location at which you want to begin recording.
- ☆ Two effect processors will be connected and effects will be applied to each track as follows:

Track 1	→	Effect unit 1
Track 2	→	Effect unit 2
Track 3	→	Effect unit 1
Track 4	→	Effect unit 2

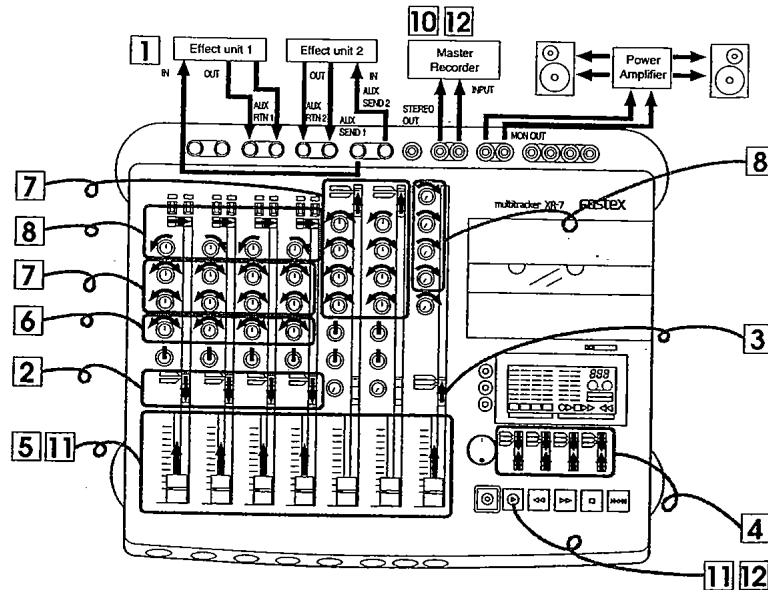

1 Connecting the master recorder and the effect units

- Connect the XR-7's STEREO OUT L and R jacks to the master recorder's [INPUT] jacks.
- Connect two effect units as shown in the diagram.

2 [INPUT SEL] switch settings

- Set the channel 1–4 [INPUT SEL] switches to "TAPE."

3 [MON SEL] switch settings

- Set the switch to "STEREO."

4 [REC SELECT] switch settings

- Set all the [REC SELECT] switches to "OFF."

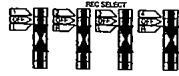

5 Adjusting the playback signal

- While playing back four tracks, gradually raise the channel 1–4 [INPUT] faders and check the level meter for the entire level balance.

6 [PAN] knob settings

- Rotate the [PAN] knob of each channel to the desired stereo position.

7 Equalizer settings

- Use the equalizer knobs of channels 1–4 to equalize the tone.
- To equalize the mix signal of tracks 1–4, first set the [EQ SEL] switches to "L" and "R", then use the parametric equalizer to adjust the tone.

8 AUX settings

- Set the channel 1–4 [AUX SEL] switches to "CH."
- Gradually rotate the channel 1 and 3 [AUX] send knobs toward "AUX 1" and turn the [AUX SEND 1] master knob to adjust the signal sent to effect unit 1.
- Gradually rotate the channel 2 and 4 [AUX] send knobs toward "AUX 2" and turn the [AUX SEND 2] master knob to adjust the signal sent to effect unit 2.
- Rotate the [AUX RTN 1] and [AUX RTN 2] knobs to adjust the input level from the effect units.

9 [FB] knob settings

- You do not need to use the [FB] knob.

10 Master recorder settings

- Insert the tape on which the master recording will be made, and rewind it to the location at which you want to begin recording.
- Set the master recorder to the REC-PAUSE status so that you can check the master recorder's input level.

11 Rehearsal

- Press the [PLAY] button to start the tape.
- Use the channel 1–4 [INPUT] faders to adjust the volume of each track.
- Use the [MASTER] faders to adjust the output level at the STEREO OUT L and R jacks, and check the input level on the master recorder.
- After finishing rehearsal, rewind the tape.

12 Start the mixdown

- First start recording on the master recorder.
- Press the [PLAY] button on the XR-7 to start the tape.
- If necessary, fade-in or fade-out the recording.

Advanced Operations (After you have mastered basic operation)

At this point, you have worked through Steps 1–5 and have learned the basic techniques for operating the XR-7. In this section, you will learn more advanced multitrack recording techniques, such as punching in/out and using tape synchronization.

STEP 6: Punch in/out

In this Step we will explain how to monitor the signals from tracks 1–4 and punch in/out a guitar solo recorded on track 1.

What is punch in/out?

Punch in/out refers to a technique in which you re-record only a specific part of a previously recorded track. For example, this technique can be used to re-record just a few measures of a guitar solo. You can playback the tape, and when you reach the section you want to re-record, press a footswitch to enter record mode without having to stop the tape. This is called “punching in.” Then when you reach the end of the section you want to re-record, press a footswitch to return to play mode. This is called “punching out.”

Convenient Rehearsal function

The XR-7’s Rehearsal function allows you to rehearse punching in/out as many times as you wish. In Rehearsal mode, recording is muted (no recording is made). Practice as much as you like before starting a real punch in/out recording.

Preparation and tips

- ☆ Before you begin, initialize the controls of the XR-7.
- ☆ Insert the tape and rewind it to a location shortly before the point where you want to begin punch in recording.
- ☆ Route the track 1–4 signals to [FB].
- ☆ You will need a Fostex 8051 footswitch (sold separately).

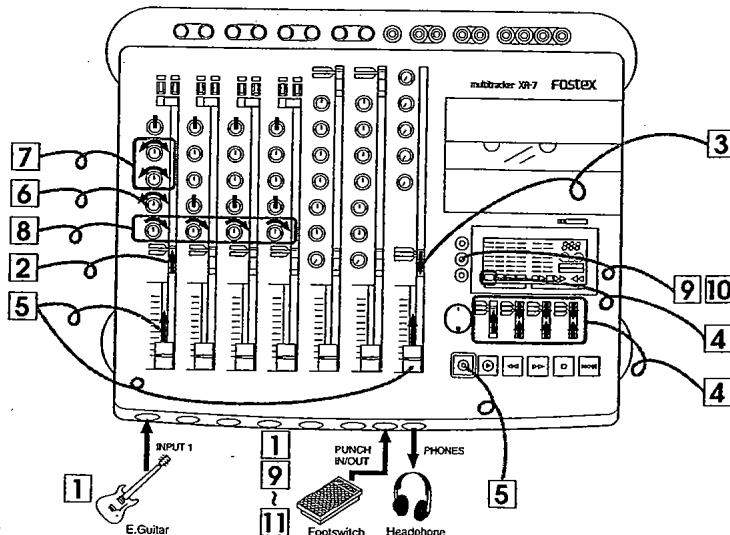

1 Connect the sound source and footswitch

- Connect the guitar to the [INPUT] jack 1.
- Connect the footswitch to the [PUNCH IN/OUT] jack.

2 [INPUT SEL] switch settings

- Set the channel 1 [INPUT SEL] switch to "INPUT."

3 [MON SEL] switch settings

- Set the switch to "FB."

4 [REC SELECT] switch settings

The track 1 [REC TRACK] indicator  will flash.



5 Adjusting the input signal

- Press the [REC] button to set track 1 to input monitor.
- Raise the [MASTER] faders to about 7 or 8.
- While playing the guitar, move the channel [INPUT] fader and check the level meter.

6 [PAN] knob settings

- Using the channel 1 [PAN] knob allows you to adjust the balance between the left and right monitor sounds.
- The channel 2–4 [PAN] knobs are not used.

7 Equalizer settings

- Use the channel 1 equalizer to adjust the guitar tone.

8 [FB] knob settings

- Gradually rotate the channel 1–4 [FB] knobs toward "TRK" to adjust the track 1–4 playback signals.

9 Rehearsal

- Press the [REHEARSAL] button. (When Rehearsal mode is ON, the [REHEARSAL] indicator will light up.)
- Play back the tape, and press the footswitch immediately before the section you wish to punch in.
Track 1 is temporarily muted. Play the guitar solo with the playback. (Adjust the recording level while rehearsing.)
- When the section you wish to re-record ends, press the footswitch again. The original track 1 signal will be heard.

10 Punch in

- Press the [REHEARSAL] button to turn Rehearsal mode OFF. (The [REHEARSAL] indicator will turn off.)
- Play back the tape, and press the footswitch precisely at the beginning of the section you wish to punch in. Only track 1 will enter record mode, and the sound of your guitar performance will be recorded on track 1.
- You can monitor the new recording signal on track 1 between punch in and punch out time.

11 Punch out

- When the section you wish to re-record ends, immediately press the footswitch again. Recording will end, and you will be able to monitor the playback signal from track 1.

12 Playback

- Leave the control panel settings as they are, rewind the tape and play it back.
- Gradually rotate each channel's [FB] knob toward the "TRK" side to monitor the tape signal.
- If the results are not satisfactory, try the punch in/out procedure again.

STEP 7: Ping-pong recording

What is ping-pong recording?

Ping-pong recording refers to a technique in which the playback from two or more previously-recorded tracks is mixed and recorded onto a different track. Ping-pong recording can be used to free up tracks so that more sound sources can be recorded on them, allowing you to create recordings with more parts than actual tape tracks.

[Example] A seven-part ensemble using ping-pong recording

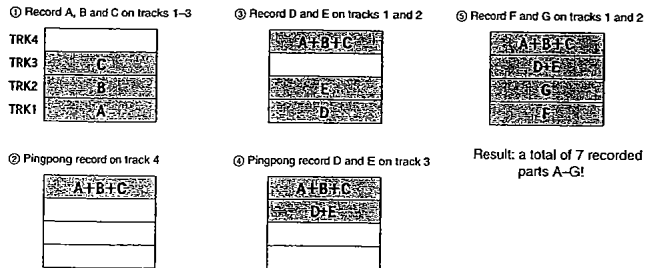

Preparation and tips

- ☆ In this Step, we will explain how you can combine tracks 1-4, add new sound sources A, B, and C to the mix, and process it with an effect while being re-recorded onto track 4.
- ☆ Before you begin, initialize the controls of the XR-7.

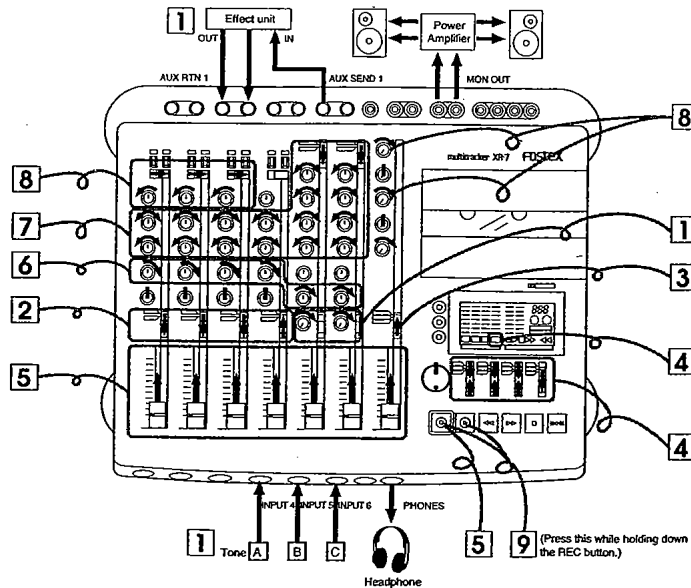

1 Connecting sound sources and effect unit

- Connect sound sources A, B, and C to the [INPUT] jacks 4, 5, and 6.
- Use the [TRIM] knobs, if necessary, to adjust the level of the sound sources connected to the [INPUT] jacks 5 and 6.
- Connect the effect unit to the [AUX SEND 1] and [AUX RTN 1] jacks.

2 [INPUT SEL] switch settings

- Set the channel 1–3 [INPUT SEL] switches to “TAPE.”
- Set the channel 4 [INPUT SEL] switch to “INPUT.”

3 [MON SEL] switch settings

- Set the switch to “STEREO.”

4 [REC SELECT] switch settings

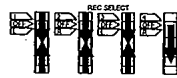

The track 4 [REC TRACK] indicator **4** will flash.

5 Adjusting the input signal

- Raise the [MASTER] faders to about 7 or 8.
- Press the [REC] button to set track 4 to input monitor. (The [REC] indicator will flash.)
- Adjust the track 1–3 playback signals using the channel 1–3 [INPUT] faders.
- Adjust the input signals of sound sources A, B, and C using the channel 4–6 [INPUT] faders.

6 [PAN] knob settings

- Turn the channel 1–6 [PAN] knobs fully toward “R.”

7 Equalizer settings

- Use the channel 1–3 equalizers to adjust the tone of tracks 1–3.
- Use the channel 4–6 equalizers to adjust the tone of sound sources A, B, and C (Set the [EQ SEL] switches to “INPUT 5” and “INPUT 6.”)

8 AUX settings

- Set the channel 1–3 [AUX SEL] switches to “CH.”
- Gradually rotate the channel 1–3 [AUX] knobs toward “AUX 1”, and adjust the entire level using the [AUX SEND 1] master knob.
- Use the [AUX RTN 1] knob to adjust the input level from the effect unit.

9 Start ping-pong recording

- When you finish adjusting the volume, tone, and effect for each track, press the [REW] button to rewind the tape to the beginning of the song.
- Press the [COUNT RESET] button to set the counter to “000.”
- Press the [PLAY] button while holding down the [REC] button to start ping-pong recording.
During recording, watch the level meters and make sure that they do not go all the way to the top. If they do, adjust the levels, and re-do the ping-pong recording.
- When you finish recording, press the [STOP] button.

Note:

Be aware that excessively high levels or excessively high equalizer settings can interfere with adjacent tracks, causing oscillation.

10 Playback

- Press the [0 RTN] button to rewind the tape.
- Change the channel 4 [INPUT SEL] switch settings to “TAPE.”
- Press the [PLAY] button to play back the tape.
- Use the channel 4 [INPUT] fader to adjust the volume level. (Leave the other channel’s [INPUT] faders to the minimum level.)
- Use the channel 4 [PAN] knob to change the stereo image.

STEP 8: **Tape Sync Recording (MIDI/TAPE Multi-mix function)**

What is tape sync recording?

Tape sync is a technique by which a performance recorded on tape can be synchronized to the automatic playback of a sequencer or drum machine (or other MIDI device). This provides the following advantages:

- Since there is no need to record the sound of the MIDI device's playback on tape, you can conserve tracks.
- Since the MIDI instrument (synthesizer, drum machine, etc.) is recorded directly to the master tape, the sound retains its original dynamic range and high quality.
- Additional advanced editing techniques are made possible, such as overdubbing the automatic playback, or re-arranging drum machine rhythm patterns.

When you use tape sync, one of the tape tracks is used to record and playback a synchronization signal known as an FSK signal. The track containing the FSK signal performs a role similar to an orchestra conductor. When the FSK signal is played back and sent to the sequencer or drum machine, the sequencer or drum machine will play back in synchronization with the tempo map recorded in the signal, and will cause the other connected MIDI devices to play back as well.

Note:

Some MIDI devices are not able to input or output FSK signals. If this is the case with your MIDI device, you will need a separate MIDI/FSK converter. For details, consult the manual for your MIDI device.

STEP 8-1:

Before you begin tape sync (Recording the sync signal)

- ☆ Before beginning tape sync, you need to record the sync signal on track 4.
- ☆ Before you begin, initialize the controls of the XR-7.

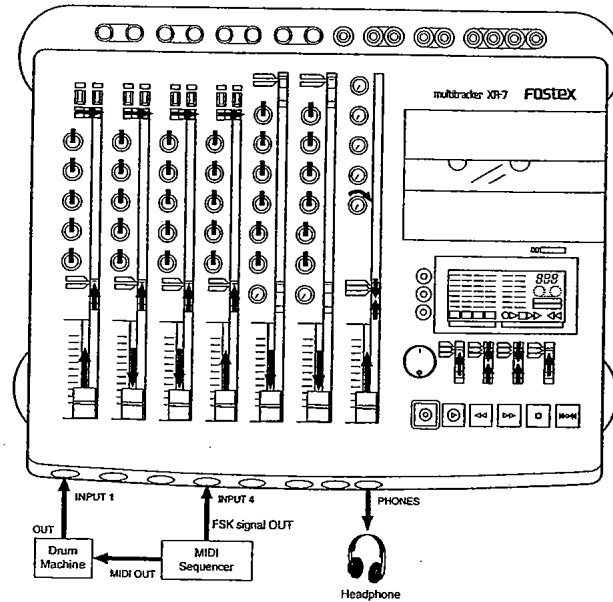

1 Connections between the XR-7 and the MIDI devices

- Connect the XR-7 to the MIDI devices as shown in the left diagram.

2 Record the FSK signal

- First you must create a rhythm program on your drum machine or sequencer.
- Specify the tempo and record the FSK signal onto track 4.
- At this time, record the sound of the drum machine onto track 1 to use as a reference track. (Be sure to record at an appropriate tempo, since the tempo cannot be changed later.)
- * Refer to the manual of your MIDI device regarding the appropriate level for the FSK signal. The manual of your MIDI device will also give the required length of the pilot tone (the high pitched pure tone of the FSK signal that indicates the standby condition before recording begins).

3 Overdubbing to tracks 2 and 3

- While monitoring the guide rhythm on track 1, overdub other sound sources to tracks 2 and 3. Refer to STEP 3 for details about overdubbing.

STEP 8-2:

Preparation and tips

- ☆ In this example we will synchronize six MIDI sound sources with the sounds recorded on tracks 1-3, and mix down to the master recorder (MIDI/TAPE Multimix mode).
- ☆ You can apply effects to the input signals and tape playback signals, if you like (Post Foldback Send function).
- ☆ Before you begin, initialize the controls of the the XR-7.

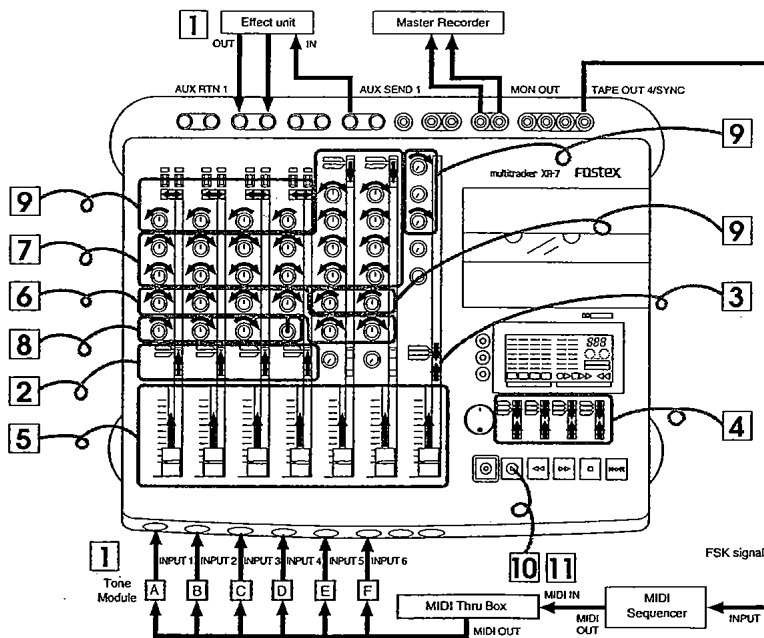

1 Connections between the XR-7 and master recorder and effect unit

- Connect the six MIDI sound sources to [INPUT] jacks 1–6.
- Connect the [MON OUT L], [R] jacks to the master recorder's [INPUT] jacks.
- Connect the effect unit to the XR-7's [AUX SEND 1] and [AUX RTN 1] jacks.

2 [INPUT SEL] switch settings

- Set the channel 1–4 [INPUT SEL] switches to "INPUT."

3 [MON SEL] switch settings

- Set the switch to "ST+FB."

4 [REC SELECT] switch settings

- Set all the switches to "OFF."

**5** Adjusting the input signal

- Raise the [MASTER] faders to about 7 or 8.
- While manually playing the MIDI sound sources A–F, gradually raise the channel 1–6 [INPUT] faders to adjust the overall balance, and check the recording level on the meters.

6 [PAN] knob settings

- Use the channel 1–6 [PAN] knobs to adjust the stereo position of each MIDI sound source.

7 Equalizer settings

- Use the channel 1–6 equalizers to adjust the tone of sound sources A–F. (Set the [EQ SEL] switches to "INPUT 5" and "INPUT 6.")

8 [FB] knob settings

- Gradually rotate the channel 1–3 [FB] knobs in the "TRACK" direction to adjust the signals from tracks 1–3.
- Set the track 4 [FB] knob to "0" (center position).

9 AUX settings

- Processing the signals of sound sources A–F with effects:
Set the channel 1–3 [AUX SEL] switches to "CH."
- Processing the tape playback signal: (Post Foldback Send function)
Set the channel 1–3 [AUX SEL] switches to "FB."
- Gradually rotate the channel [AUX] send knobs toward "AUX 1", and adjust the entire level using the [AUX SEND 1] master knob.
- Use the [AUX RTN 1] knob to adjust the input level from the effect unit.

10 Rehearsal

- Press the [PLAY] button to play back the XR-7, and start the MIDI device.
- Use the [FB] knobs to adjust the signal of tracks 1–3, and use the [INPUT] faders to adjust the volume balance of the MIDI sound sources.
- Adjust the amount of effect, if necessary.
- After finishing rehearsal, rewind the tape to the beginning.

11 Mixdown the tape sync playback

- First start recording on the master recorder.
- Play back the XR-7 and start the MIDI device.
- Use the [MASTER] fader to control the overall volume, and to fade-in or fade-out, if necessary.

Troubleshooting

	Problem	Points to check	Action
Sound trouble	• Sound is unsteady or interrupted.	Are the pinch roller or capstan dirty? Is the tape damaged?	Clean the pinch roller and capstan. Use a new, good-quality tape.
	• Sound quality or volume is significantly different than when recorded.	Is the head dirty?	Clean the head.
		Are you using other than a high-position tape? What is the setting of the Dolby NR switch?	Use a high-position tape (Chrome, type II) Restore the same setting as recording.
	• Sound is distorted or noisy.	Are the TRIM knobs and INPUT faders set appropriately? Are the level meters peaking or at an extremely low level?	Adjust the INPUT fader to appropriate level settings.
	• Playback pitch is different than when recorded.	Is the PITCH control at the same setting as when you recorded?	Set the PITCH control to the same setting as for recording.
Recording trouble	• Cannot send sound to the desired track; cannot record.	Are the REC SELECT switches set correctly? Are the PAN knob settings correct?	Check the settings. Stereo bus L is routed to tracks 1 and 3, and stereo bus R is routed to tracks 2 and 4.
	• Oscillation occurs during ping-pong recording.	Is the recording level too high, or is the EQ control for the high frequency range set too high?	Lower the level as appropriate.
	• The sound recorded on a track is re-recorded on the current recording track during overdubbing.	Is the recorded data routed to the stereo bus during overdubbing?	Route the pre-recorded data to FB instead of to the stereo bus.
	• Cannot record.	Are the record-protect tabs of the cassette broken off? Is the MASTER fader raised?	Put sticky tape over the record-protect depressions of the cassette. Raise the MASTER fader.
	• Sound sources connected to INPUT jacks 1-4 cannot be recorded.	Are the INPUT SEL switches set to [TAPE]?	Set the INPUT SEL switches to [INPUT].
Transport trouble	• Tape does not move.	Is the cassette inserted correctly? Inserted all the way?	Insert the cassette correctly.
	• Power does not come on.	Is the AC adaptor connected correctly?	Connect the AC adaptor correctly.
Effect processing trouble	• Effects are not applied even if you turn each channel's AUX send knob.	Are the AUX SEND master knob and AUX RTN knob raised?	Set these knobs to an appropriate position.
	• Tape sync operation does not work.	Is the level of the recorded FSK signal at an appropriate level? Has the tape dropped out?	Refer to your sequencer or drum machine manual to record the signal at an appropriate level. If the tape is defective, replace it with a new tape.

Maintenance

1. Cleaning the exterior

- **For normal cleaning, use a soft dry cloth.**

For stubborn dirt, moisten a cloth in diluted detergent, wring it out firmly, and wipe the dirt off. Then polish with a dry cloth.

Never use solvents such as alcohol, thinner or benzene, since these will damage the printing and finish of the exterior.

2. Cleaning the head, roller and capstan

- **Record/playback head**

As the XR-7 is used, the record/playback head will become coated with oxide residue from the tapes. If this residue is allowed to build up, recordings will contain more noise, and dropouts may occur during playback. To prevent this, regular cleaning is important. Use a commercially available cleaning kit etc. to clean the head. If cleaning the head does not restore the sound quality, it is possible that the head is worn. Contact an authorized service station for repair.

- **Capstan and pinch roller**

The capstan and pinch roller are important parts that hold the tape and move it along at the correct speed. As with the head, these parts can also become dirty with oxide residue and dust, which will cause increased wow or flutter, or even damage the tape by pulling it out of the cassette.

Since cassette tape is very thin, it is especially dangerous to use a cassette deck with dirty pinch rollers. As with the head, it is important to always keep these parts clean. Clean them using a cotton swab or gauze soaked in cleaning solution or isopropyl alcohol. Never use organic solvents such as lacquer thinner, since this will severely damage the pinch rollers.

3. Demagnetizing the head

After long periods of use, the head begins to develop a magnetic field in addition to the oxide residue described above. This can also occur if a magnet or a magnetized object (scissors, etc.) is allowed to come near the head or touch it. If the head or capstans become magnetized, frequency response will be degraded and noise will increase. In extreme cases, noise can be created on previously recorded tapes that you playback, rendering them useless.

Once a month or so, you should use a demagnetizer (head eraser) to demagnetize the head. Carefully read and follow the instructions included with your demagnetizer, and do not allow it to come near recorded tapes.

Specifications

Mixer

Inputs (x6)	
Inputs 1-4	
Input impedance	10 k Ω
Normal input level	-10 dBV
Inputs 5, 6	
Microphone impedance	Less than 10 k Ω
Input impedance	20 k Ω
Normal input level	-60 dBV--10 dBV
AUX RTN 1, 2 (L, R)	
Input impedance	8 k Ω
Normal input level	-20 dBV
INSERT 5/L, 6/R	
SEND (tip)	
Output load impedance	10 k Ω or higher
Normal output level	-10 dBV
RETURN (ring)	
Input impedance	10 k Ω
Normal input level	-10 dBV
STEREO OUT L, R	
Output load impedance	10 k Ω or higher
Normal output level	-10 dBV
AUX SEND 1, 2	
Output load impedance	10 k Ω or higher
Normal output level	-10 dBV
Foldback (FB)	
Output load impedance	10 k Ω or higher
Normal output level	-10 dBV
Monitor output (MON OUT L, R)	
Output load impedance	10 k Ω or higher
Normal output level	-10 dBV
Tape output (TAPE OUT 1-4/SYNC)	
Output load impedance	10 k Ω or higher
Normal output level	-10 dBV
Headphone output (PHONES)	
Output load impedance	40 Ω
Normal output level	80 mW
Equalizer	
Shelving	HIGH: 10 kHz \pm 12 dB LOW: 100 Hz \pm 12 dB
Parametric	HIGH: 10 kHz \pm 12 dB MID: 200 Hz-5 kHz \pm 12dB LOW: 100 Hz \pm 12 dB
Frequency response	20 Hz-20 kHz
Crosstalk	60 dB (1 kHz)
Distortion	Less than 0.05%

Recorder

Recording tape	C-60, C-90 (Type II / High (CrO ₂) position) TDK SA, MAXELL XLII equivalent
Record tracks	4 tracks, one direction (simultaneous recording of up to four tracks possible)
Noise reduction	Dolby C NR (internal) (switchable on/off)
Tape speed	9.5 cm/s, 4.75 cm/s (switchable)
Wow/flutter	\pm 0.07% (IEC/ANSI, 9.5 cm/s)
Fast wind time	120 seconds (C-60 tape)
Pitch control	\pm 10% (9.5 cm/s only)
Recording time	22.5 minutes (C-90 tape, 9.5 cm/s)
Frequency response	
Mixer	20 Hz-20 kHz
Recorder	40 Hz-18 kHz (9.5 cm/s)
Signal/noise ratio	65 dB (Dolby C NR IN, IHF-A)
Crosstalk	higher than 50 dB (1 kHz)
Erasure ratio	70 dB or higher (1 kHz)
Distortion	Less than 2.0% (1 kHz, 0dB)
Heads	
Rec/Play	4-channel record/playback (hard permalloy)
Erase	4-channel (ferrite)
Power Requirement	DC12V (12-16V), 13W (Fostex AC adaptor, AD-12T)
Weight	3 kg (excludes AC adaptor)
Dimensions (mm)	405 (W) \times 321 (D) \times 105 (H)

- * Specifications and appearance are subject to change without notice for product improvement.
- * Dolby Noise Reduction is manufactured under license from Dolby Laboratories Licensing Corporation.
- * Dolby and the double-D symbol are trademarks of Dolby Laboratories Licensing Corporation.

Block Diagram

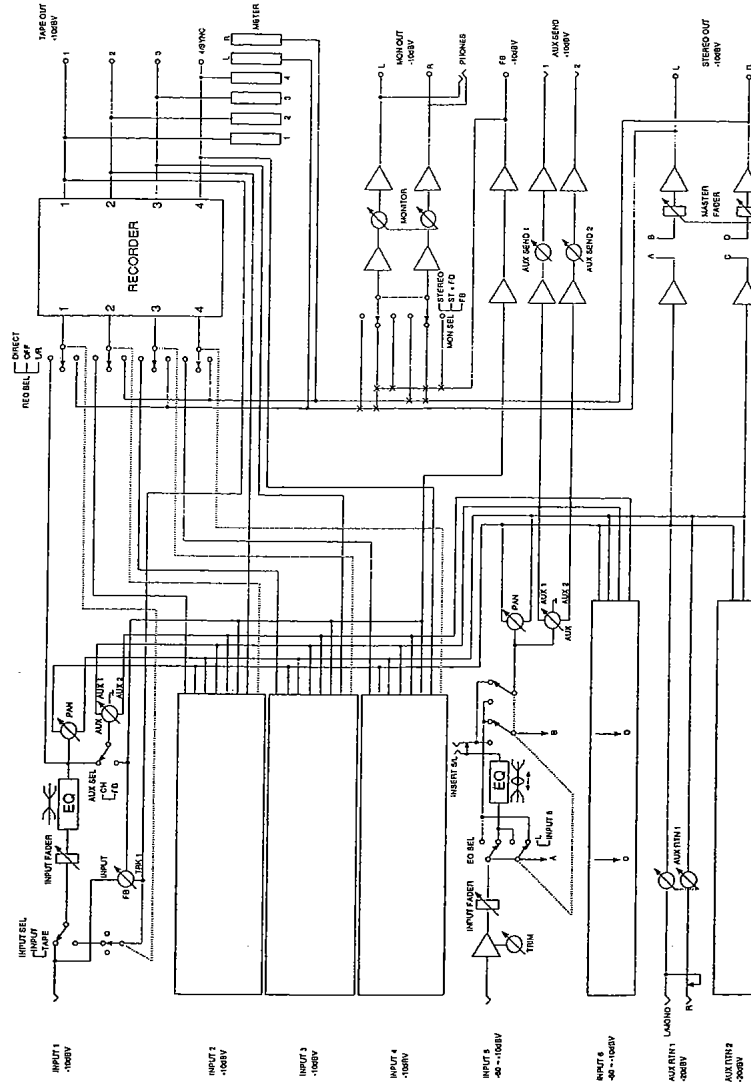

Fostex

FOSTEX CORPORATION 3-2-35 Musashino, Akishima-shi, Tokyo, Japan 196

FOSTEX CORPORATION OF AMERICA 15431, Blackburn Ave., Norwalk, CA 90650, U.S.A.

© PRINTED IN JAPAN DEC. 1994 8288 345 000 F
