





LOCATION RECORDER
Model **PD204**



Owner's Manual

FOSTEX

	CAUTION	
RISK OF ELECTRIC SHOCK DO NOT OPEN		
<p>CAUTION: TO REDUCE THE RISK OF ELECTRIC SHOCK, DO NOT REMOVE COVER (OR BACK). NO USER - SERVICEABLE PARTS INSIDE. REFER SERVICING TO QUALIFIED SERVICE PERSONNEL.</p>		

<p>CAUTION: TO PREVENT ELECTRIC SHOCK, MATCH WIDE BLADE OF PLUG TO WIDE SLOT, FULLY INSERT.</p> <p>ATTENTION: POUR ÉVITER LES CHOCS ÉLECTRIQUES, INTRODUIRE LA LAME LA PLUS LARGE DE LA FICHE DANS LA BORNE CORRESPONDANTE DE LA PRISE ET POUSSER JUSQU' AU FOND.</p>



The lightning flash with arrowhead symbol, within an equilateral triangle, is intended to alert the user to the presence of uninsulated "dangerous voltage" within the product's enclosure that may be of sufficient magnitude to constitute a risk of electric shock to persons.



The exclamation point within an equilateral triangle is intended to alert the user to the presence of important operating and maintenance (servicing) instructions in the literature accompanying the appliance.

"WARNING"

"TO REDUCE THE RISK OF FIRE OR ELECTRIC SHOCK, DO NOT EXPOSE THIS APPLIANCE TO RAIN OR MOISTURE."

SAFETY INSTRUCTIONS

1. Read Instructions - All the safety and operating instructions should be read before the appliance is operated.
2. Retain Instructions - The safety and operating instructions should be retained for future reference.
3. Heed Warnings - All warnings on the appliance and in the operating instructions should be adhered to.
4. Follow Instructions - All operating and use instructions should be followed.
5. Water and Moisture - The appliance should not be used near water - for example, near a bathtub, washbowl, kitchen sink, laundry tub, in a wet basement, or near a swimming pool, and the like.
6. Carts and Stands - The appliance should be used only with a cart or stand that is recommended by the manufacturer.



An appliance and cart combination should be moved with care. Quick stops, excessive force, and uneven surfaces may cause the appliance and cart combination to overturn.

7. Wall or Ceiling Mounting - The appliance should be mounted to a wall or ceiling only as recommended by the manufacturer.
8. Ventilation - The appliance should be situated so that its location or position does not interfere with its proper ventilation. For example, the appliance should not be situated on a bed, sofa, rug, or similar surface that may block the ventilation openings; or, placed in a built-in installation, such as a bookcase or cabinet that may impede the flow of air through the ventilation openings.
9. Heat - The appliance should be situated away from heat sources such as radiators, heat registers, stoves, or other appliances (including amplifiers) that produce heat.
10. Power Sources - The appliance should be connected to a power supply only of the type described in the operating instructions or as marked on the appliance.
11. Grounding or Polarization - The precautions that should be taken so that the grounding or polarization means of an appliance is not defeated.

12. Power Cord Protection - Power supply cords should be routed so that they are not likely to be walked on or pinched by items placed upon or against them, paying particular attention to cords at plugs, convenience receptacles, and the point where they exit from the appliance.
13. Cleaning - The appliance should be cleaned only with dry cloth.
14. Nonuse Periods - The power cord of the appliance should be unplugged from the outlet when left unused for a long period of time.
15. Object and Liquid Entry - Care should be taken so that objects do not fall and liquids are not spilled into the enclosure through openings.
16. Damage Requiring Service - The appliance should be serviced by qualified service personnel when:
 - A. The power supply cord or the plug has been damaged; or
 - B. Objects have fallen, or liquid has been spilled into the appliance; or
 - C. The appliance has been exposed to rain; or
 - D. The appliance does not appear to operate normally or exhibits a marked change in performance; or
 - E. The appliance has been dropped, or the enclosure damaged.
17. Servicing - The user should not attempt to service the appliance beyond that described in the operating instructions. All other servicing should be referred to qualified service personnel.
18. The appliance should be situated away from drops of water or spray of water.
19. Objects containing liquid such as vase must not be put on the appliance.
20. The appliance is not completely isolated from the power supply even if the power switch is at off position.
21. Appliance shall not be exposed to dripping or splashing and no objects filled with liquids, such as vases, shall be placed on the appliance.
22. Only use attachments/accessories specified by the manufacturer.
23. An appliance with a protective earth terminal should be connected to a mains outlet with a protective earth connection.
24. An appliance should be placed in a position where an AC plug/inlet can be easily pulled out by hand.
25. Main plug is used as the disconnection device. It shall remain readily operable and should not be obstructed during intended use. To be completely disconnected the apparatus from supply mains, the mains plug of the apparatus shall be disconnected from the mains socket outlet completely.

Important Safety Instructions

- 1) Read these instructions.
 - 2) Keep these instructions.
 - 3) Heed all warnings.
 - 4) Follow all instructions.
 - 5) Do not use this apparatus near water.
 - 6) Clean only with dry cloth.
 - 7) Do not block any ventilation openings. Install in accordance with the manufacturer's instructions.
 - 8) Do not install near any heat sources such as radiators, heat registers, stoves, or other apparatus (including amplifiers) that produce heat.
 - 9) Do not defeat the safety purpose of the polarized or grounding-type plug. A polarized plug has two blades with one wider than the other. A grounding type plug has two blades and a third grounding prong. The wide blade or the third prong are provided for your safety. If the provided plug does not fit into your outlet, consult an electrician for replacement of the obsolete outlet.
 - 10) Protect the power cord from being walked on or pinched particularly at plugs, convenience receptacles, and the point where they exit from the apparatus.
 - 11) Only use attachments/accessories specified by the manufacturer.
 - 12) Use only with the cart, stand, tripod, bracket, or table specified by the manufacturer, or sold with the apparatus. When a cart is used, use caution when moving the cart/apparatus combination to avoid injury from tip-over.
- 
- 13) Unplug this apparatus during lightning storms or when unused for long periods of time.
 - 14) Refer all servicing to qualified service personnel. Servicing is required when the apparatus has been damaged in any way, such as power-supply cord or plug is damaged, liquid has been spilled or objects have fallen into the apparatus, the apparatus has been exposed to rain or moisture, does not operate normally, or has been dropped.

Table of contents

Introduction of this manual	11
Precautions	11
Cautions for use	13
Precautions of installation	13
Chapter-1: Main features	15
Main features and functions	16
What is in the box?	19
PD204 options and related Fostex products	19
Chapter-2: Preparation before using the PD204	21
Preparation of power supply	22
Mounting the battery	23
Important settings for using the battery	24
Battery priority setting (essential when using more than one battery)	24
Low battery warning setting	24
Power supply priority setting (essential when using both [DC-IN] and a battery)	25
Protector adjustment	25
Saving the battery power	26
Battery condition display	26
Dismounting the battery	27
Using [DC-IN] (Connecting the AC adaptor)	28
Important settings for using [DC-IN]	28
Low battery warning setting	28
Power supply priority setting (essential when using both [DC-IN] and a battery)	28
Turning on the power	29
Display backlight and contrast	30
Turning on the display backlight	30
Adjusting the display contrast	30
Turning off the power	30
Internal clock setting	31
Preparation of a DVD-RAM disk	33
Inserting a disk	33
Initial format of a DVD-RAM disk	34
Replacing the internal hard disk drive	37

Chapter-3: Names and functions	39
Left side panel (inputs/outputs)	40
Right side panel (inputs/outputs)	42
Front panel	44
Top panel	52
Rear panel	54
LCD display details	55
Home screen	55
Time display	55
Status information	56
File name/Next file name	57
Disk remaining	57
Current drive/file number	57
Protect icon	57
Screen examples	58
MENU list screen	58
SYS SETUP menu screen	58
BATTERY SETUP menu screen	58
TC SETUP menu screen	58
DISK UTILITY menu screen	58
USB to PC menu screen	58
EDIT EDL FILE menu screen	59
Audio file select screen	59
Drive select screen	59
CUE LIST screen	59
Contrast adjustment screen	59
Chapter-4: Basic connections	61
Input connection	62
Analog audio input connection	62
Digital audio input connection	63
Time code input connection	63
Sync signal connection	63
External audio signal connection for monitoring	63
Output connection	64
Analog audio output connection	65
Digital audio output connection	65
Time code output connection	65
Word clock output connection	65
Other connections	66
USB keyboard connection	66
PC connection	68
External controller connection	68
Power connection	69

Connection examples	70
Connection example for recording (1)	70
Connection example for recording (2)	71
Chapter-5: Recording/playback	73
Preparation before recording	74
Setup for recording in quick setup mode	74
How to make settings in the quick setup mode	74
Frame rate selection for LTC (or external time code)	75
System clock reference selection	75
Sampling frequency and bit length selection	76
TC recording mode setting	76
Clock pull up/pull down setting	76
Power source priority selection	77
Setting in the MENU mode	77
Default file name setting	77
Maximum file size setting	77
Partition link setting	77
Error tone output setting	78
Mixer settings	78
Input signal selection	79
High-pass filter setting	79
Limiter setting	79
Adjusting the input gain (for channels 1 through 4)	80
Phase setting (for channels 1 through 4)	82
Controlling signals sent to the stereo bus	82
Monitoring recording signals	83
Selecting the drive for recording	84
Recording analog audio	85
Starting recording	85
About overloading during recording	86
Canceling recording (False Start)	86
Recording in Pre rec mode	87
Recording a slate tone/slate mic signal	88
Recording digital audio	89
Selecting the sampling frequency/bit length	89
Selecting the system clock	89
Recording time code	90
Selecting the TC frame rate	90
Selecting the TC generator mode (TC recording mode)	90
Automatic record start by external time code	91
Setting the time code output	91
Force jam to external time code	92

Cue point setting	93
Setting a cue point on the fly during audio recording	93
Viewing the cue point list	93
Editing a cue point	94
Editing a cue label	94
Editing cue point data	94
Deleting a cue point	95
Adding a new cue point to the cue point list	95
Basic playback	96
Normal audio playback	96
Cueing playback	97
Time code playback	97
Skip/locate functions	98
Skipping by file	98
Skipping by cue point	98
Locating to the beginning (ABS 0) of a file	99
Locating to the end (REC END) of a file	99
Locating to the previous locate point	99
Locating to the desired time	100
Locating to the desired cue point	101
Chapter-6: Advanced operations	103
Auto copy function	104
Setting a partition	104
Selecting auto copy mode	105
Making auto copy	106
Disk copy function	107
Selecting source drive	107
Making disk copy	108
File copy function	110
Selecting source drive	110
Making file copy	111
Dual drive recording	113
Formatting in the “DDR” mode	113
Making dual drive recording	115
Data export to PC	116
Connecting PC to the unit	117

How to unmount the PD204 from the PC	117
Example of copying data to a computer hard disk	118
Example of exporting data to a computer application	118
Chapter-7: Creating and editing ALE files (EDIT EDL FILE menu)	121
Creating a new ALE file	122
Adding audio file entries to an ALE file	125
Viewing and editing audio file entries	127
Viewing audio file entries	127
Adding an audio file entry to an existing ALE file	128
Deleting an audio file entry	128
Editing an ALE file	129
Editing an ALE file name	129
Remarking an ALE file	130
Deleting an ALE file	131
Chapter-8: MENU mode	133
About MENU mode	134
SYS SETUP menu	136
Project name setting [Set project name]	137
Default file name setting [Default file name]	138
Default track name setting [Default TrkName]	140
Next event number setting [Next event No]	141
Recording FS/bit length setting [Record FS&Bit]	142
Pull up/down setting [Pull up/down]	143
Digital output signal format selection [Digital out]	144
Diagnoses file setting [Diagnoses]	145
Peak hold time setting [Peak hold]	146
Slate tone/pop tone recording mode setting [Tone rec mode]	147
Pause cancel time setting [Pause time]	149
USB keyboard type setting [Keyboard]	150
Pre recording time setting [Pre rec time]	151
Maximum file length setting [Max file length]	152
Continuous recording function [Auto part. link]	153
False start mode setting [False start]	155
Limiter parameter setting [Limiter parameter]	156

ANALOG OUT nominal level setting [Stereo out level]158

Monitor speaker mute setting [Speaker mute]159

Error tone output setting [Error tone]160

Chain play mode setting [Chain play]163

ROM version checking [Version]164

BATTERY SETUP menu165

 Battery low voltage warning setting [BATT. warning]166

 DC-IN low voltage warning setting [DC-IN warning]167

 Power supply priority setting [Power priority]168

 Battery priority setting [Active battery]169

 Battery setting examples170

 Battery remaining time [BATT. Remain]172

 Battery status [BATT. status]173

TC SETUP menu174

 System clock selection [Sync clock]175

 TC frame rate selection [Frame rate]176

 Generator mode selection [Gen mode]177

 Internal TC generator setting [Set Gen. TC]178

 User bit setting [Set Gen Ubit]180

 Jam mode setting [JAM mode]182

 Time code output source selection [Sel. TC Out]183

 Default LTC start time setting [Default LTC start]184

 LTC start time editing [Edit LTC start]185

 UBIT setting of playback time code [Ref TC Ubit]186

 Time code output while paused [Rep pause TC]187

 Automatic recording start by external TC [Recin via ExtTC]188

 Internal TC generator power-off timer setting [TC PWR Timer]189

DISK UTILITY menu190

 Editing a file name [Edit file name]191

 Viewing a file information and editing descriptor information [File info.]192

 Editing descriptor information194

 Adding descriptor information194

 Deleting descriptor information194

 Viewing iXML Chunk data information195

 Editing iXML Chunk data information195

 Deleting an unnecessary audio file [Delete file]196

 Restoring a deleted audio file [Restore Del. file]197

 Formatting a disk (or a hard disk partition) [Format]198

 Editing the reel number (Volume label) [Reel No.]202

 Record protection On/Off setting [Rec protect]203

Resume function On/Off setting [Resume]	204
Partition protection On/Off setting [Part. protect]	205
HDD operating time display [HDD Ope. Time]	206
LOAD SETUP menu	207
SAVE SETUP menu	208
Chapter-9: Specifications	209
Inputs/outputs	210
Recording/playback	211
General	211
Physical dimensions	212
Block diagram	213
INDEX	214

Introduction of this manual

This manual is a guidebook for using the Fostex PD204 Location Recorder. This manual is intended for users who have experience and knowledge of using a professional digital recorder.

You may roughly understand how to use the PD204 by reading "Chapter 1: Main features" and "Chapter 3: Names and functions".

"Chapter 3: Names and functions" describes names and functions of keys, controls and connectors, as well as reference pages. So you can refer to this chapter as index for detail information.

"Chapter 2: Preparations before using the PD204" contains the necessary information when using the PD204 for the first time, such as "About power supply" and "Initial format of a DVD-RAM disk".

Precautions

- For supplying the power to the unit from an AC outlet, only use the Fostex authorized AC adaptor (optional).
If you use any unauthorized AC adaptor, the unit may not work correctly and there is a serious risk of damage to the unit.
- Make sure that the voltage of your AC power outlet matches the voltage requirements printed on the AC adaptor.
If you wish to use the unit in a country where the voltage of the AC power outlet does not match your AC adaptor, ask your local Fostex dealer or service station for purchasing an appropriate AC adaptor. Note that the AC adaptor can be used both in 50 Hz and 60 Hz areas.
- Never supply voltage other than DC12V to the unit.
- Only use the IDX ENDURA or NP-1 type battery (if you use the NP-1 type battery, the dedicated holder and holder plate are needed).
* IDX, IDX (logo), ENDURE, V-Mount, V-Plate, Digi-View and i-Trax are the trademarks of IDX Company Ltd..
- When inserting/replacing batteries or disconnecting the AC adaptor, make sure that the unit main power is off. Otherwise, memory data may be damaged because the unit always handles data while the power is on.
- While the unit is accessing to a disk, never turn off the power. Make sure that the unit completely stops accessing to the disk before you turn off the power. Otherwise, recorded data may be lost, as well as the internal hard disk or DVD drive may be damaged.

<Note>: Fostex assumes no responsibility on data loss or whatsoever due to use of the unit.

<Note>: Fostex is not responsible for any "direct damage" or "indirect damage" caused by using the unit.

- Do not let water or other liquid, or metal objects such as pins, accidentally enter the inside of the unit (especially inside of the disk tray) because this may lead to electric shock or damage. Should water enter the inside of the unit, turn off the power, unplug the AC adaptor and remove batteries, and consult your dealer or the nearest FOSTEX service station.
- Do not drop the unit or give it a strong shock. Doing so may damage the internal circuits, display or panels. Handle the unit with great care because it is a precision mechanical device.
- Do not open the case or touch inside the unit because of the danger of electric shock and failure.
- Do not give a strong shock to the LCD display. The liquid used inside the LCD display is toxic. If the liquid is spilled, do not suck it in. If it is stained to your hand or skin, wash immediately with plenty of water.
- Though the unit is designed to be used outside, it is not perfectly waterproofed. So do not use the unit where it catches the rain or spray directly.

<About replacing the lithium battery>

The unit contains the internal lithium battery for running the internal clock. The battery should be replaced approximately every five years. To replace the battery, ask your dealer or the nearest FOSTEX service station. If the battery is not correctly replaced, there may be a risk of explosion, etc.

<Important!>

The model name, power requirement and serial number for the PD-204 are indicated on the bottom side.



Cautions for use

If you make recording or playback using a DVD-RAM disk, do not hang the unit using the shoulder belt, which may damage the DVD drive. Put the unit on a horizontal surface within the adjustable range of the height adjustment arm.

* You can put the unit vertically when you make recording to the internal hard disk.

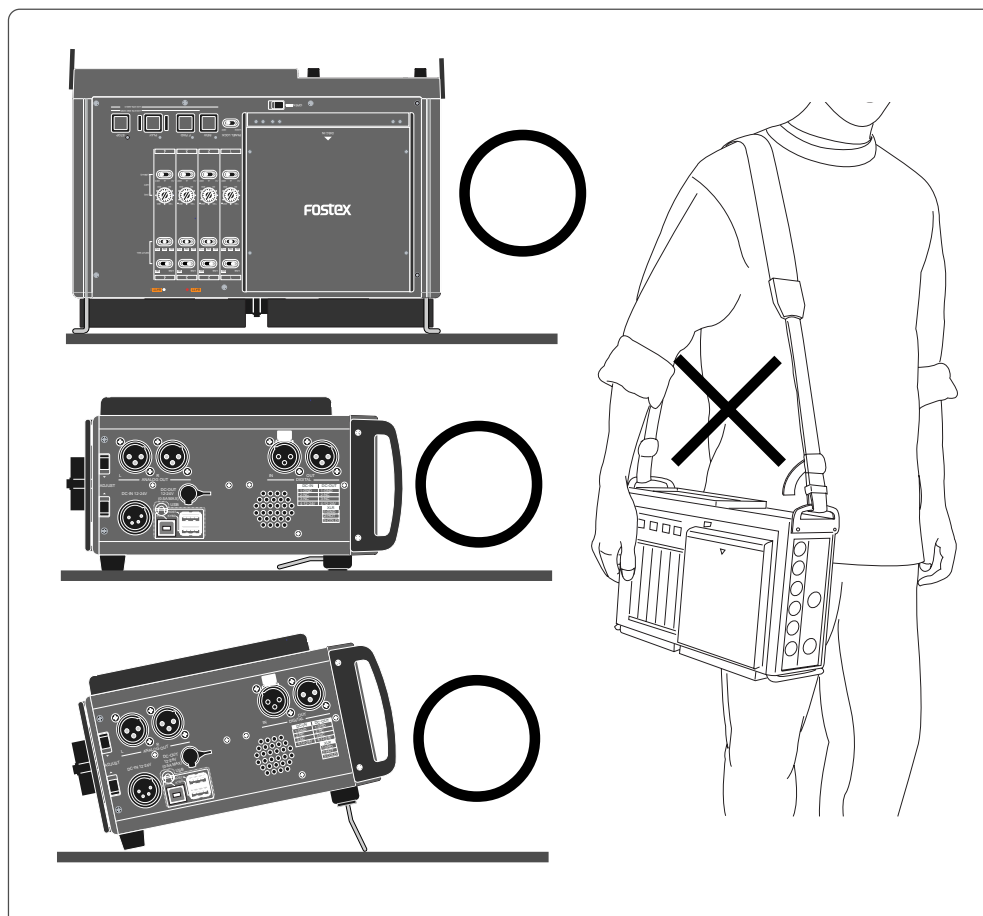

Precautions on installation

- **Do not install the unit in the following conditions**
 - * In an extremely hot or cold place
 - * In a moist place
 - * In a vibrated place
 - * In a dusty place
 - * In a strong magnetic field or near a device which generates a magnetic field
 - * In the direct sunshine
 - * In the direct shower or rain
- **Notes on moisture condensation**

When you bring the unit from a cold place to a warm place, moisture may condense on the drive, display, panels, etc. In such a case, leave the unit for a while until it warms up and evaporates any moisture.

Chapter 1: Main features

Main features and functions

- Equipped with four analog inputs and two analog outputs as well as two-channel digital input and output. You can record signals from these inputs in stereo. Two Aux analog inputs are also provided for monitoring the audio track of a camera via headphones. (Note that the Aux inputs are provided for monitoring only and you cannot record the Aux input signals.)

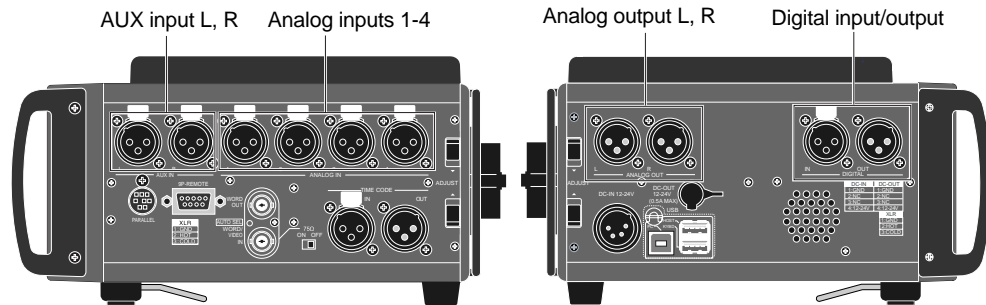

- Equipped with a 1.8-inch hard disk drive (80GB) and a 12-cm DVD multi drive as standard. You can directly make recording to the hard disk partition or DVD-RAM disk. In addition, you also can make "Auto copy", "File Copy" and "Disk Copy" between a DVD-RAM disk and a hard disk partition, as well as "Dual Drive Recording".

The internal hard disk drive can be replaced with the optional hard disk drive unit (Model EX-HD1) by a user. The DVD multi drive is the slot loading type and can accept a 4.7GB, non-cartridge DVD-RAM, DVD-R or DVD-RW disk (only a DVD-RAM disk can be used for direct recording).

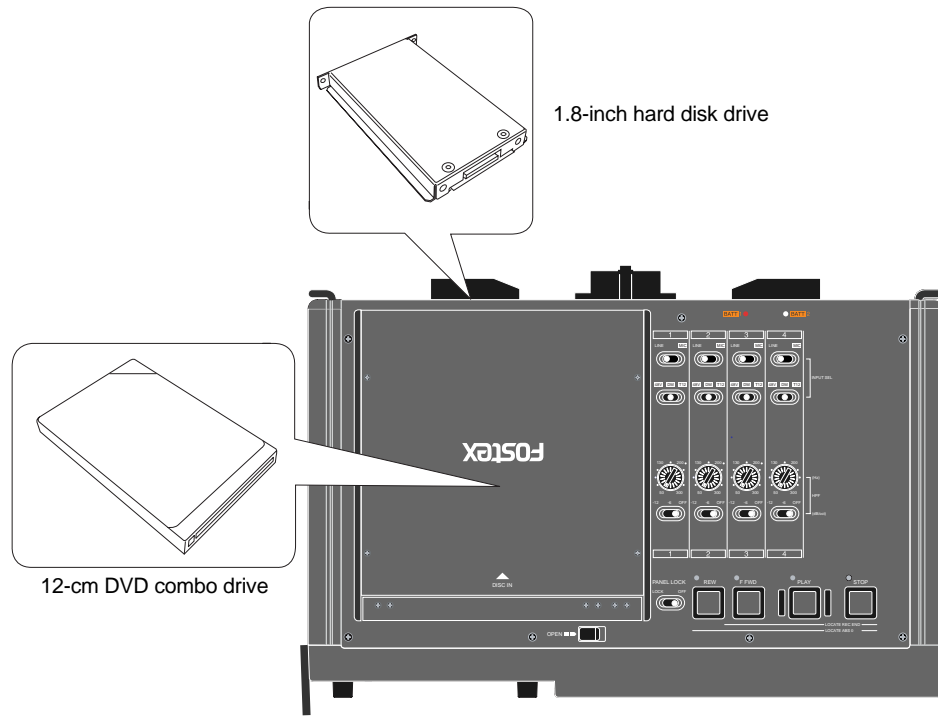

For the optional hard disk drive unit for replacement, ask your local Fostex dealer or service station.

- The DVD-RAM disk format is conformed to "UDF Rev1.5", which ensures great compatibility with personal computers.
- The recording file format is conformed to the versatile BWF format. You can export a recorded file including time code information to a BWF-compatible application.
- Can be used with the optional AC adaptor or IDX ENDURA battery (V-mount type). You can stack up to four batteries for longer recording time.
- Built in the internal generator with the jam sync function. The unit is equipped with the time code input/output connectors (XLR), so you can stripe not only the internal time code but also an external time code.

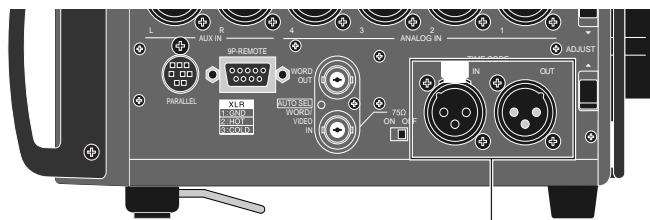

TIME CODE IN/OUT connectors

- Provides the word sync function, allowing synchronization with external digital equipment.

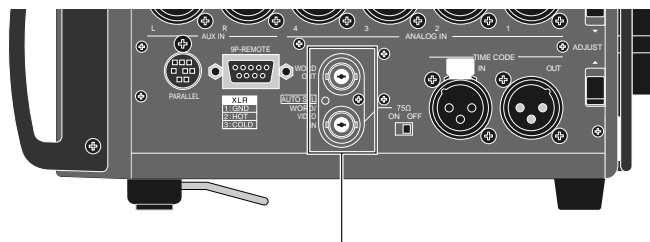

WORD/VIDEO IN and WORD OUT connectors

- Equipped with the [USB PC] port for PC connection. You can directly connect to a PC, allowing to mount the internal hard disk and DVD drives to the PC. The unit also provides the [USB HOST] port for future expansion. In addition, the [USB KYBD] port is also provided for USB keyboard connection, which allows you to enter file names and volume labels from a USB keyboard.

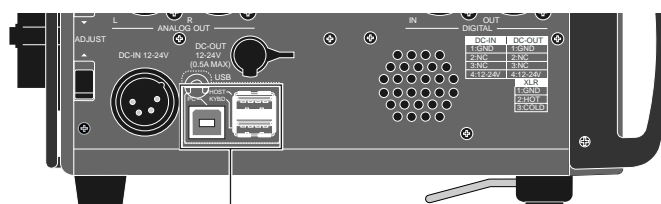

USB port

- You can export a recorded audio file to the AVID system by creating the ALE file.
- The Mark/Cue function allows to store markers (cue points) during recording. You can locate or skip to a cue point quickly.
- The "False start" function allows to cancel recording easily.
- "Pre Record" function allows glitch-free recording. When this function is active, recent audio data is pooled in the buffer and recording starts from the audio data in the buffer.
- During recording, the audio file is automatically saved every minute in background.
- Equipped with the digital mixer which you can enjoy intuitive analog-like operation.

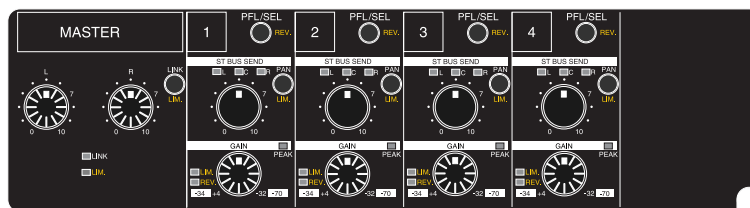

Mixer section

- In 24-bit/48kHz mode, you can record up to approximately 256 minutes onto two tracks.
* The times shown above are the recording times on a DVD-RAM disk (4.7GB) or a partition (approx. 4.5GB) of the hard disk.
- In 24-bit mode, you can make recording with sampling frequencies of 44.1/48 kHz, 88.2 kHz, 96 kHz, 176.4 kHz and 192 kHz.

In 16-bit mode, you can make recording with sampling frequencies of 44.1 kHz and 48 kHz.

What is in the box?

Make sure that the box contains the following. If any of them are missing, please contact your dealer.

PD204	1
Shoulder belt	1
Operation manual (this manual)	1
Driver software (CD)	1

PD204 options and related Fostex products

The following PD204 options and related products are available. Ask your local Fostex dealer or sale office for details about them such as prices, specifications, etc.

You can also get product information from our web site below.

<http://www.fostex.com>

Options

- AC adaptor: Model AD15-4300 or AD-15C
- 1.8-inch hard disk drive: Model EX-HD1
- Battery plate: Model EX-BP1
- Soft case: Model ZP-62

Related products

- Location recorder: Model PD606
- DVD multitrack recorder: Model DV824
- Portable location recorder: Model FR-2LE
- Personal powered monitor: Model 6301B/BX/BE
- Stereo headphones: Model T20RPMkII/T-5/T-7/T40RPMkII/T50RP

Chapter 2: Preparation before using the PD204

This chapter explains what you should do before using the PD204 for the first time, including power connection, internal clock setting and preparation of the DVD-RAM disk. It also explains how to replace the internal hard disk drive.

Chapter 2 - Table of contents

Preparation of power supply	22
Mounting the battery	23
Important settings for using the battery	24
Battery priority setting (essential when using more than one battery)	24
Low battery warning setting	24
Power supply priority setting (essential when using both [DC IN] and battery) ..	25
Protector adjustment	25
Saving the battery power	26
Battery condition display	26
Dismounting the battery	27
Using [DC IN] (Connecting the AC adaptor)	28
Important settings for using [DC IN]	28
Low battery warning setting	28
Power supply priority setting (essential when using both [DC IN] and battery) ..	28
Turning on the power	29
Display backlight and contrast	30
Turning on the display backlight	30
Adjusting the display contrast	30
Turning off the power	30
Internal clock setting	31
Preparation of a DVD-RAM disk	33
Inserting a disk	33
Initial format of a DVD-RAM disk	34
Replacing the internal hard disk drive	37

Preparation of power supply

The unit can operate on the mobile IDX ENDURA or NP-1 type battery, as well as the dedicated AC adaptor.

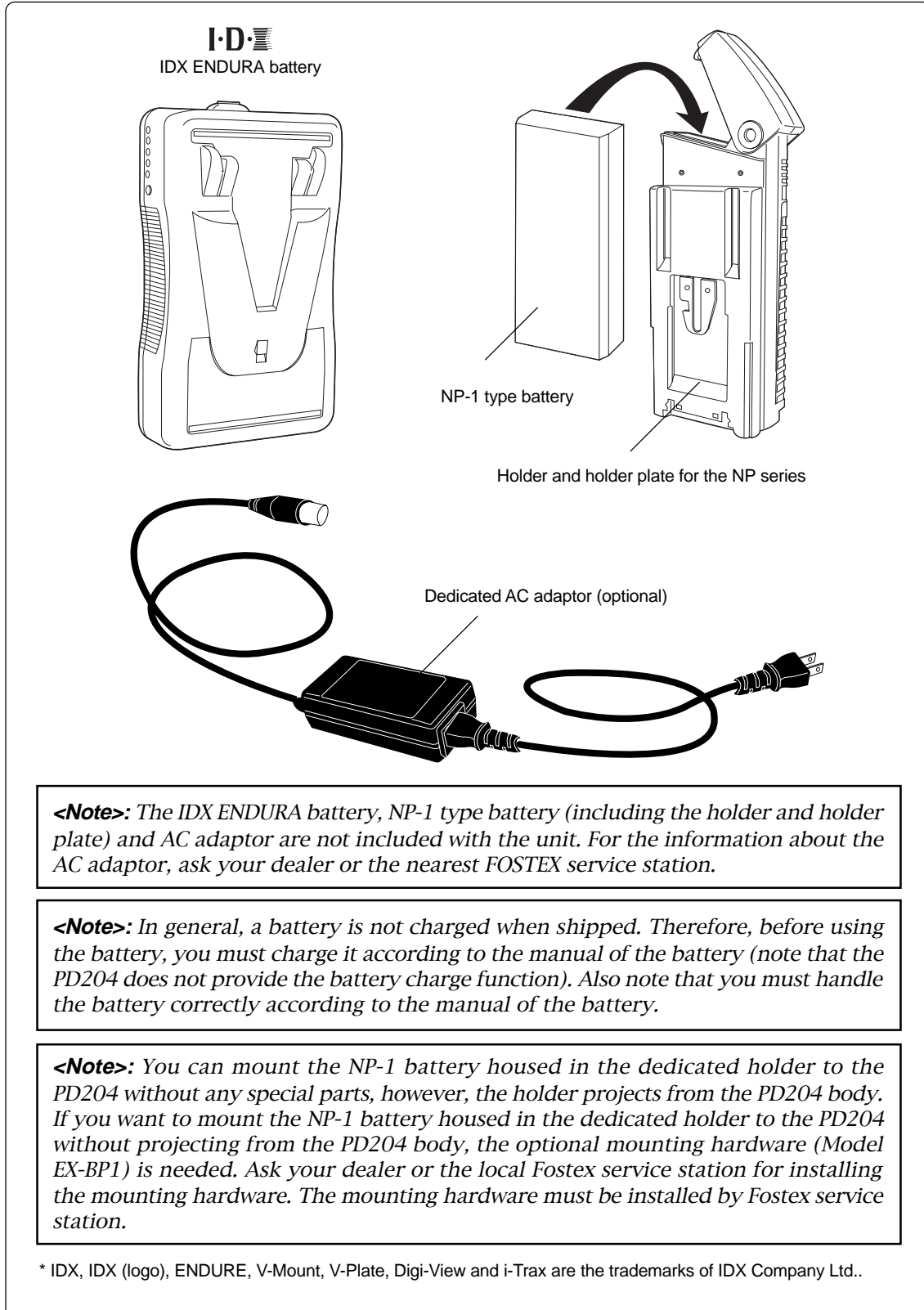

Mounting the battery

The ENDURA battery is mounted to the bottom of the PD204. There are two mounts for mounting the batteries. If you use the non-PowerLink type batteries, you can mount one battery for each base. If you use the PowerLink type batteries, you can mount up to four batteries (two batteries for each base).

<Note>: When you mount or replace the battery, make sure that the unit power is off. By sudden power failure, memory data may be reset or the unit may be damaged because the unit handles data while the power is on. However, note that, if you set two batteries, you can replace a battery which is not currently active.

<Note>: If you use the IDX ENDURA battery, read the operation manual supplied with the battery and handle it correctly. The PD204 does not provide battery charge function. Charge the IDX ENDURA battery correctly according to the battery manual.

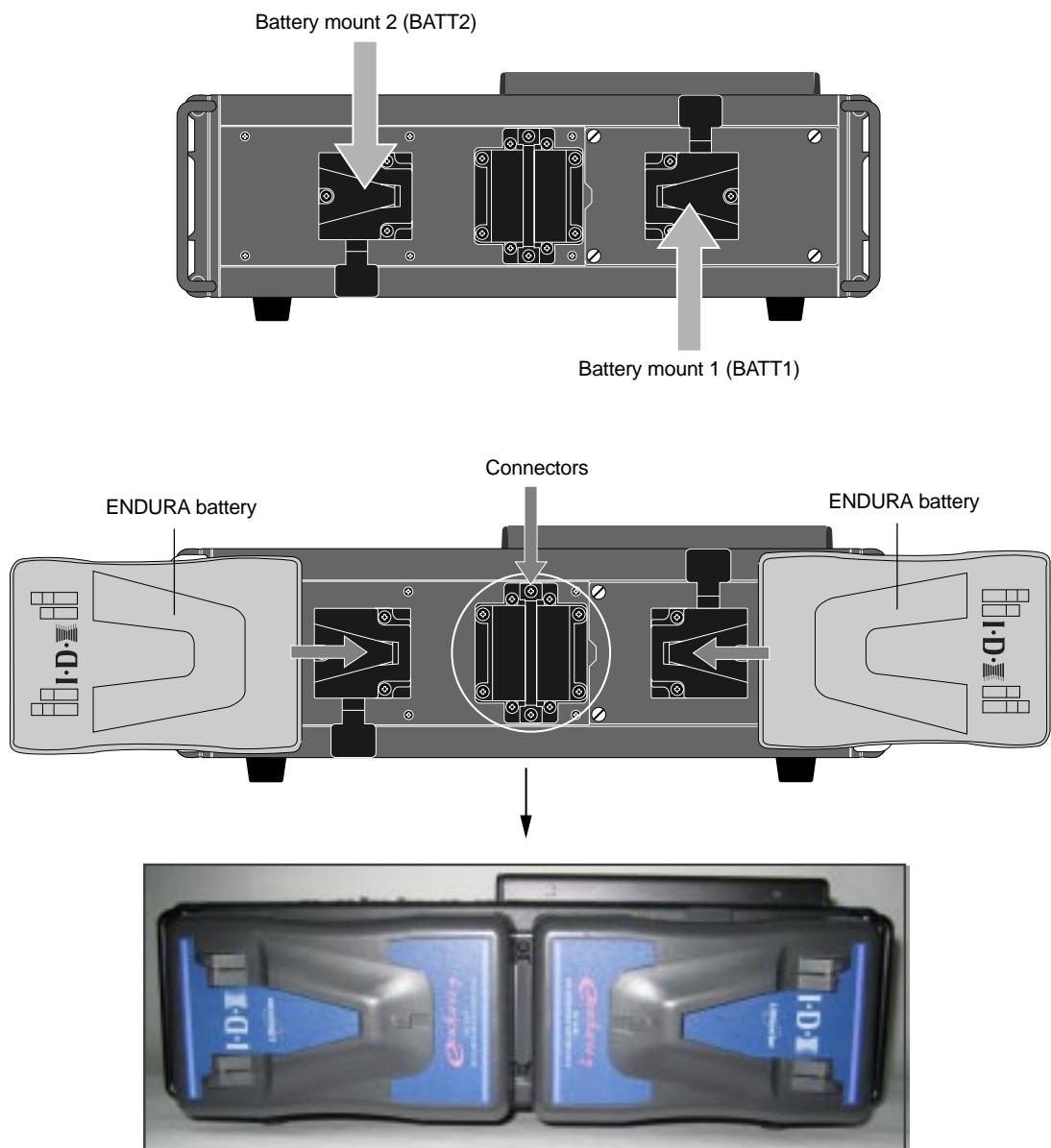

<Example of mounting the ENDURA batteries to the both battery mounts>

When you use PowerLink batteries, you can mount up to four batteries (two batteries for each base, as shown on the right).

<Note>: When you mount four batteries, you cannot use the protector on the bottom panel. Use the unit horizontally.

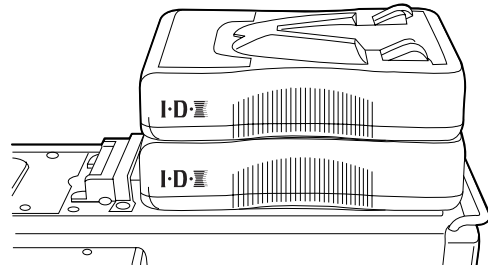

<Notes for using PowerLink batteries>

- When you use PowerLink batteries, use batteries of the same charging condition. If the charging conditions are significantly different, the PowerLink function may not operate correctly resulting the PD204 powered off.
- You cannot mount more than two batteries. Each battery mount can accept up to two batteries.

Important settings for using the battery

Battery priority setting (essential when using more than one battery)

When you use two batteries or four PowerLink batteries, you must set the battery priority (BATT1 or BATT2).

You can specify the battery to be used preferentially. When the preferential battery gets empty, the display shows the warning popup window and the other battery automatically takes over.

You can make setting via the quick setup mode or via the "Active battery" item in the "BATTERY SETUP" menu of the MENU mode (see pages 77 and 169).

Low battery warning setting

Whether you use a battery with or without BMS (Battery Management System), you can set the threshold voltage for warning low battery.

When the battery voltage gets lower than the threshold voltage you set, the warning tone is output from the headphones connected to the unit.

By default, the threshold voltage is set to 13.2V for battery with BMS or 13.0V for battery without BMS. However, you can set the desired threshold voltage via the "BATT. warning" item in the "BATTERY SETUP" menu of the MENU mode (see page 166).

<Note>: When you use a battery with BMS (Battery Management System), you can check the battery information via the "BATT. status" item in the "BATTERY SETUP" menu of the MENU mode (see page 173).

<Note>: When you use a battery with BMS (Battery Management System), you can check the remaining time until the battery voltage reaches the threshold voltage in one-minute steps via the "BATT. Remain" item in the "BATTERY SETUP" menu of the MENU mode (see page 172).

<Note>: While the battery has power, the output voltage is between 13 V to 15 V. When the remaining power gets short, the output voltage rapidly drops. Therefore, to replace the battery well in advance, we recommend setting the threshold voltage to 13 V or around.

Power supply priority setting (essential when using both [DC IN] and a battery)

When you use both a battery and the [DC IN] connector, you must set the power supply priority ("DC-IN" or "BATT"). For example, if you set it to "DC-IN", the battery automatically takes over only when the power supply from the "DC-IN" jack is cut off (power failure, disconnection, etc).

Note that, if you use only batteries, you do not need to make this setting.

You can make setting via the "Power priority" item in the "BATTERY SETUP" menu of the MENU mode (see page 168).

Protector adjustment

When the battery is mounted, pull out the protector to protect the battery, as shown below. While sliding the [ADJUST] levers on left and right side panels to the arrow direction, pull out the protector. There are two locked positions for the protector. Set it to the appropriate position. Note that you should push it down when replacing the battery.

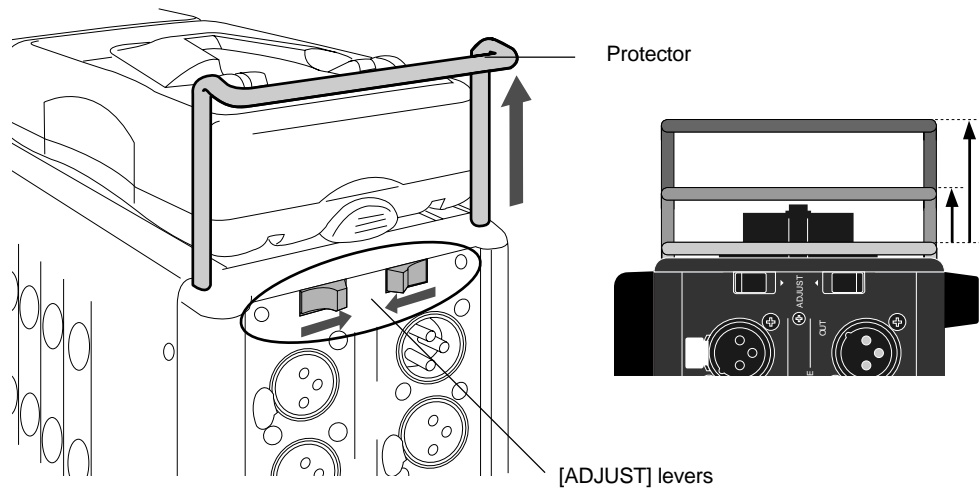

<Note>: The protector can protect the IDX ENDURA-7 and ENDURA-7S. When you use the ENDURA-10 or ENDURA-10S, or PowerLink is active, we recommend using the PD204 horizontally.

Saving the battery power

The PD204 offers the following measures for saving the battery power to extend the battery life.

- Pressing the [STOP] key stops the disk rotation to save the power consumption. It is also possible to set the desired pause release time using the "Pause time" item in the SYS SETUP menu of the MENU mode (the default pause time is three minutes).
- When the internal monitor speaker is not used or when a headphone plug is inserted to the [PHONES] jack, no power is supplied to the amplifier for the speaker.

The following describes some tips for saving the battery power, as well as some notes on using the battery.

- When you do not operate the unit on battery power for a long period of time, remove the battery. Even if the [POWER] switch is set to "OFF", a small amount of electric power is consumed.
- Set the monitor level as lower as possible (regardless of whether using headphones or the internal monitor speaker).
- You should use the display backlight only when needed.
- When you do not use a DVD-RAM disk, remove the disk.
- The load impedance connected to PD204 output connectors should be greater than 10k ohm.
- When converting a balanced output to an unbalanced output, you should not connect the unused pin to the ground pin and leave it open. Though it lowers the output level by 6dB, it does not influence to the audio characteristics.

You can check the current battery remaining amount in realtime by following the procedure described below.

Battery condition display

You can check the battery remaining amount in realtime from the [ST BUS] bargraph meters beside the LCD display on the front panel.

By pressing and holding down the [EXIT/BATT] key when you use a BMS battery and the display shows the Home screen (in stop, playback or record mode), the [ST BUS] bargraph meters show the battery remaining amount in % and the display pops up the battery power voltage in V. Releasing the [EXIT/BATT] key returns the meters to the stereo buss level monitoring and dismiss the popup window).

When you use a non-BMS battery, only the display pops up the battery power voltage.

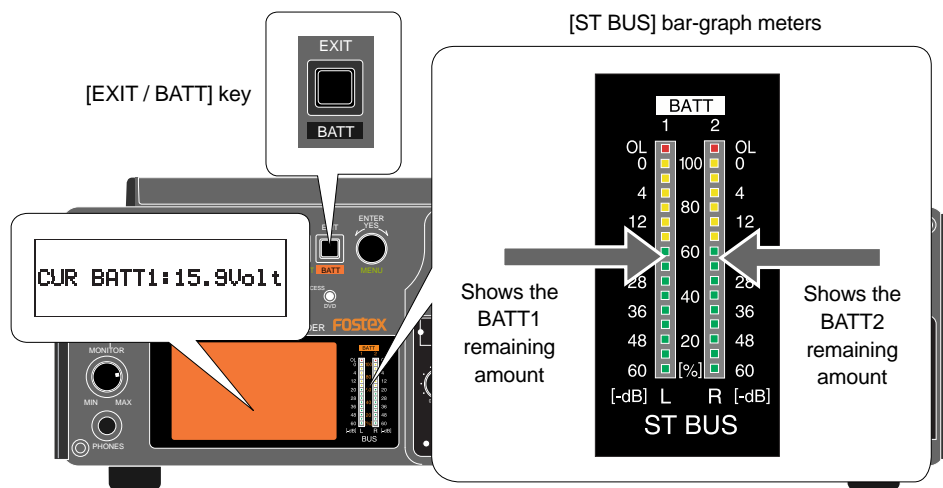

Dismounting the battery

To dismount the battery, make sure that the power is off, and remove the battery while pressing the release button on the IDX ENDURA battery or press down the eject lever on the PD204.

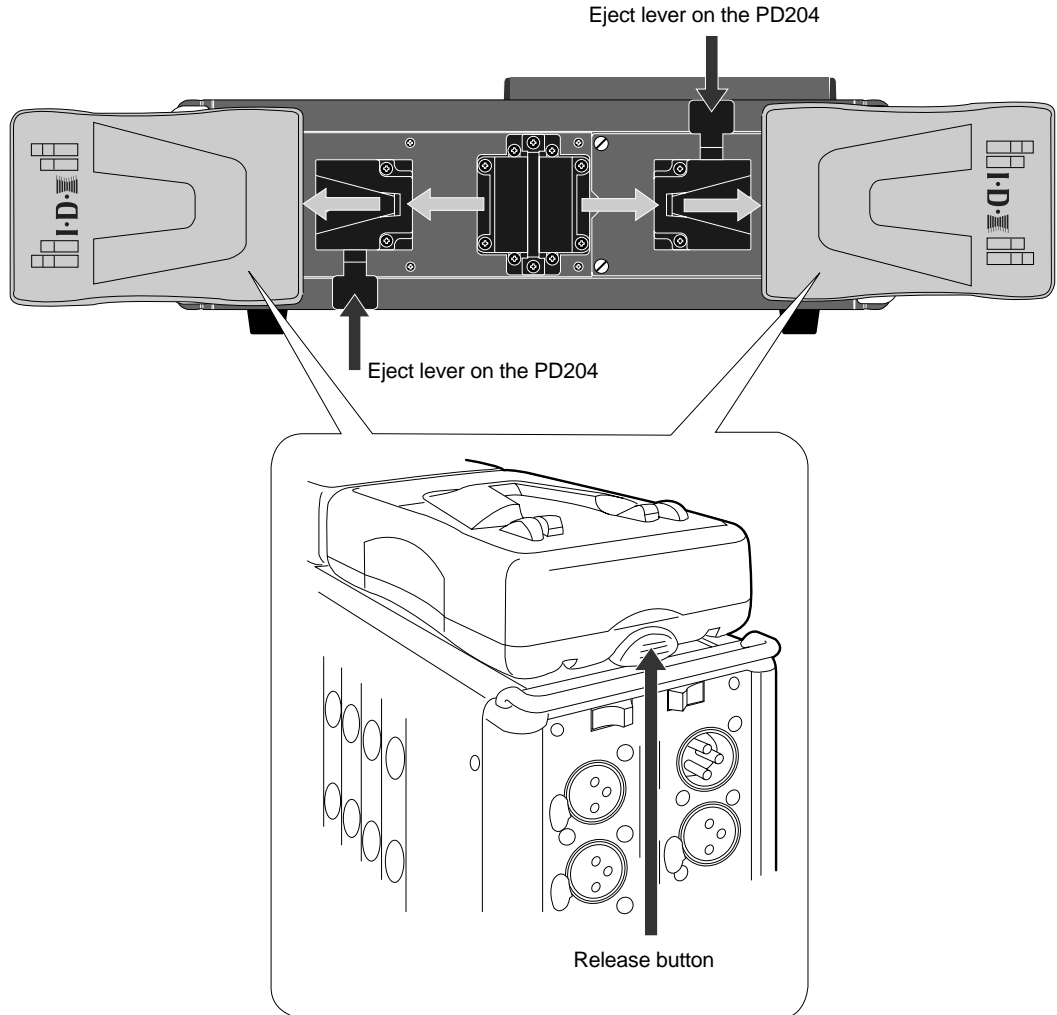

<Note>: Dispose the used battery properly (see the instruction manual of your battery). Keep the removed battery away from children.

Using [DC-IN] (Connecting the AC adaptor)

You can connect the AC adaptor or another appropriate power source to the [DC IN] connector on the left side panel of the PD204. If you use the AC adaptor, insert the XLR-4-32 type connector of the AC adaptor to the [DC IN] connector until it is locked, then connect the AC plug to the AC main outlet (see the figure below).

<Notes>

- When you connect or disconnect the connector, make sure that the power is off.
- Use only the Fostex dedicated AC adaptor. Using another AC adaptor may damage the PD204 due to the mismatch of the power voltage, polarity, etc. When connect or disconnect the AC adaptor, make sure that the [POWER] switch is set to "OFF". The AC adaptor for the PD204 is optionally available (ask your local Fostex dealer or sale office for purchasing the option).

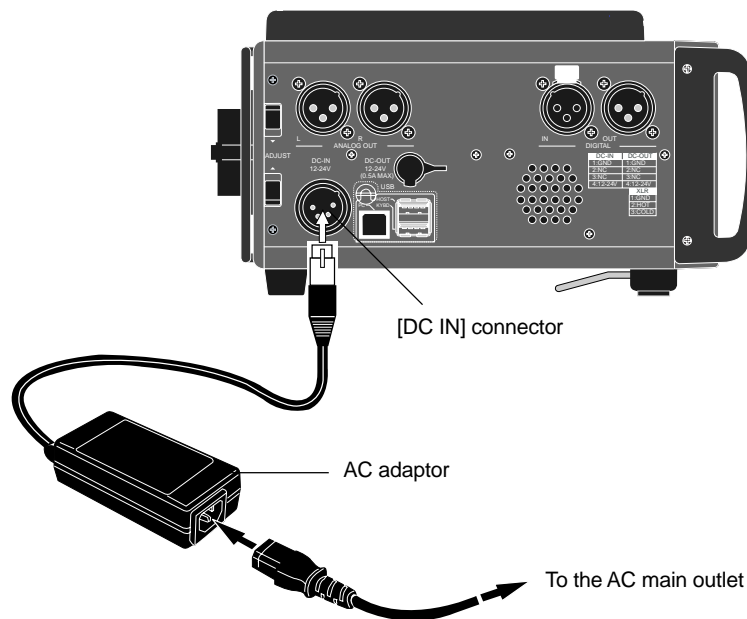

Important settings for using [DC IN]

Low battery warning setting

When you get the power from the [DC IN] connector (such as use the AC adaptor), you can set the threshold voltage for warning low battery.

When the DC-IN voltage gets lower than the threshold voltage you set, the warning tone is output from the headphones connected to the unit.

By default, the threshold voltage is set to 13.0V. However, you can set the desired threshold voltage via the "DC-IN warning" item in the "BATTERY SETUP" menu of the MENU mode (see page 167).

Power supply priority setting (essential when using both [DC IN] and battery)

When you use both a battery and the [DC IN] connector, you must set the power supply priority ("DC-IN" or "BATT"). For example, if you set it to "DC-IN", a warning message pops up on the display and the battery automatically takes over only when the power supply from the "DC-IN" jack is cut off (power failure, disconnection, etc). Note that, if you use only batteries, you do not need to make this setting.

You can make setting via the "Power priority" item in the "BATTERY SETUP" menu of the MENU mode (see page 168).

Turning on the power

After mounting the battery or connecting the power source such as the AC adaptor to the [DC IN] connector, you can turn on the power by setting the [POWER] switch to "ON". The unit starts up and the screen similar to below appears (the screen example below shows the one the first time you turn on the power after purchasing the unit).

[POWER] switch

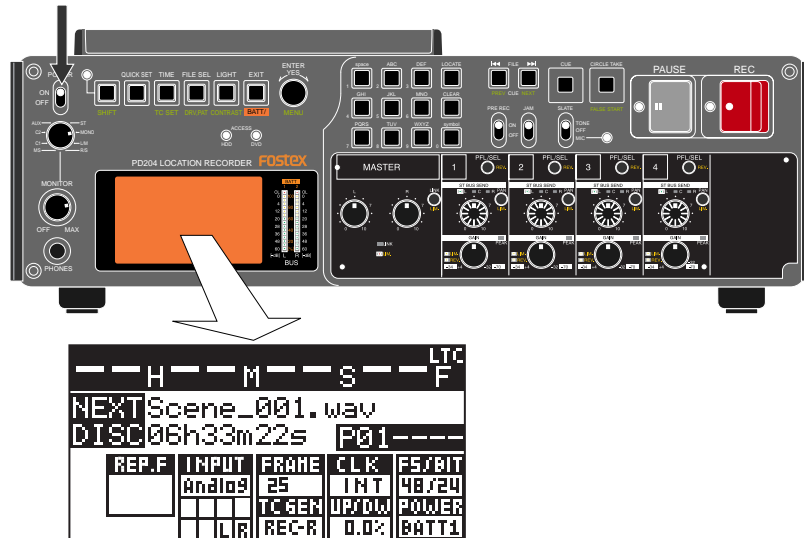

This screen shows the current drive is partition 01 of the internal hard disk and there is no file recorded in the partition. The screen also shows the next file name and remaining recordable time of the partition.

The next file name is the name of the file which is created when you start recording. By default, "Scene_001.wav" is automatically given to the file. You can specify the desired name instead of this default name using the "Default file name" item in the "SYS SETUP" menu of the MENU mode (see page 138).

The internal hard disk has been formatted when shipped. So you can make recording to the partition in this condition. The hard disk is divided into 16 partitions (approximately 4.5GB per partition). If you want to record a file to another partition, select the desired partition by using the drive selection function (see page 84).

<Note> If you make recording to a DVD-RAM disk, you must format the disk (see page 34) and select the DVD-RAM drive by using the drive selection function.

<Note> When the power is being supplied from a battery, the [BATT1] or [BATT2] indicator on the top panel lights, while the "POWER" area on the display shows "BATT1" or "BATT2". These depend on the settings of the "Active battery" and "Power priority" items in the "BATTERY SETUP" menu of the MENU mode.

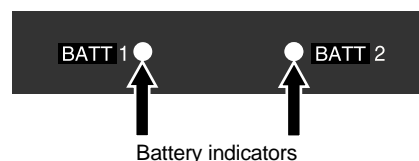

When the power is being supplied from the [DC IN] connector, both battery indicators on the top panel are unlit, while the "POWER" area on the display shows "DC-IN".

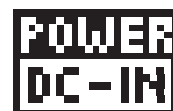

Display backlight and contrast

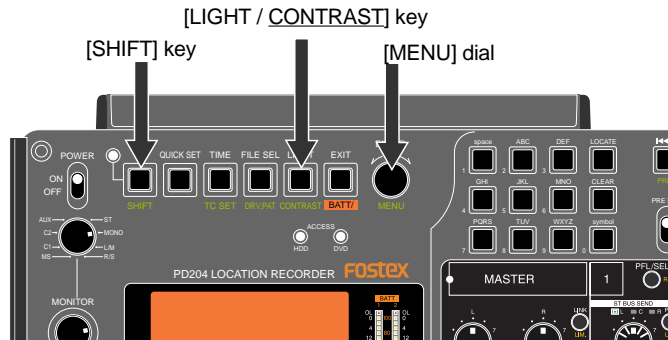

Turning on the display backlight

Turns on or off the backlight of the display.

Pressing the [LIGHT/CONTRAST] key turns on the backlight of the display, which is automatically turned off after three seconds. If you keep holding down the [LIGHT/CONTRAST] key for more than three seconds, the display shows "--Light on hold--" and the backlight keeps on lighting until you press this key again.

<Note>: When you operate the unit on battery, we recommend not using the display backlight unless necessary, because the backlight consumes the battery power.

Adjusting the display contrast

The display contrast is adjusted appropriately when shipped. However, you can adjust it as your favor by the following procedure after turning on the power.

- 1) **Press the [SHIFT] key to enter shift mode, followed by the [LIGHT/CONTRAST] key.**
The display shows the popup screen for adjusting the display contrast.



- 2) **Use the [MENU] dial to adjust the display contrast.**
Rotating the [MENU] dial clockwise weakens the contrast while rotating the dial counter clockwise strengthens the contrast.
- 3) **Press the [ENTER/YES] key to confirm the setting.**
The display contrast is set.
The popup screen is dismissed and the unit exits the contrast adjustment mode.

Turning off the power

Before you turn off the power, make sure that the unit stops access to the drive.

To turn off the power, switch the [POWER] switch to the OFF position.

The display backlight flashes weakly and slowly. This indicates that the internal TC generator is still working after turning off the main unit.

The time until the TC generator turns off is set to five minutes by default, however, you can set it to the desired time via the "TC PWR Timer" item in the "TC SETUP" menu of the MENU mode (see page 189).

Internal clock setting

The PD204 offers realtime clock.

The realtime clock data is used for a default file name when creating a new audio file on a disk, the file creation date/time information, the time code start time when recording a time code by the internal time code generator, and so on (see Notes below) .

The realtime clock is adjusted according to the local time when shipped, therefore, set the time to your local time before using the PD204 by following the procedure below.

<Note>: The realtime clock date is used for the default file name of a newly created file when the file name mode is set to "DATE" using the "Default file name" item in the "SYS SETUP" menu of the MENU mode (see page 138).

The following shows the Home screen examples which are shown when the file name mode is set to "DATE". While stopped, "<DATE>.wav" is shown in the NEXT field. During recording or playback, the file name (based on the realtime clock data) given to the current file is shown. (During playback, the remaining time is not shown.)

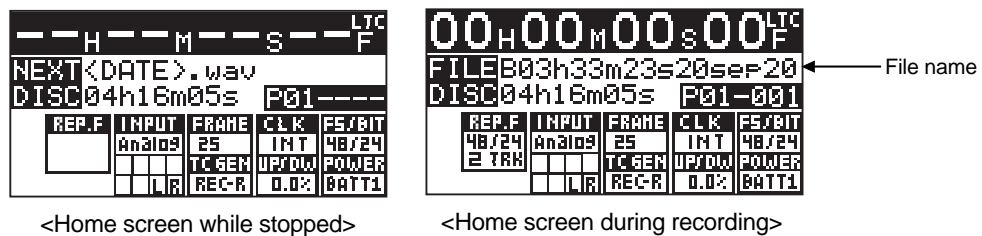

<Note>: Only when the TC GEN mode is set to "24H RUN", the realtime clock data is used as the TC start time (see pages 76 and 177 for details about the TC GEN mode).

The following procedure assumes that partition 1 (PT01) which has no recorded file is currently selected.

- 1) While the unit is stopped, press the [SHIFT] key to enter shift mode, followed by the [ENTER/YES] key.

The unit enters MENU mode and brings up the MENU list screen for selecting the desired main menu.

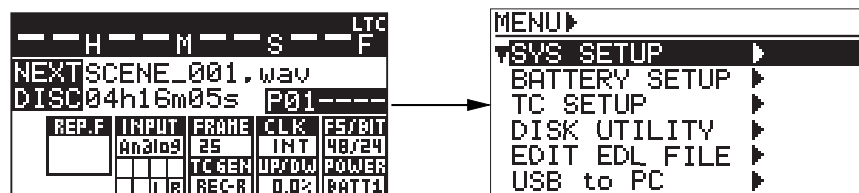

- 2) While "SYS SETUP" is highlighted, press the [ENTER/YES] key.

The display shows the SYS SETUP menu screen, on which you can select system setup menu item.

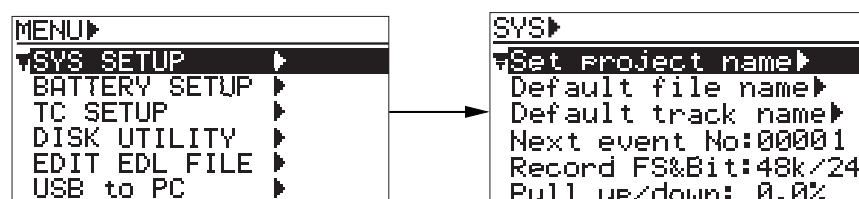

- 3) Use the [MENU] dial to select "Adjust RTC" and press the [ENTER/YES] key. The display now shows current internal clock time which runs in realtime.

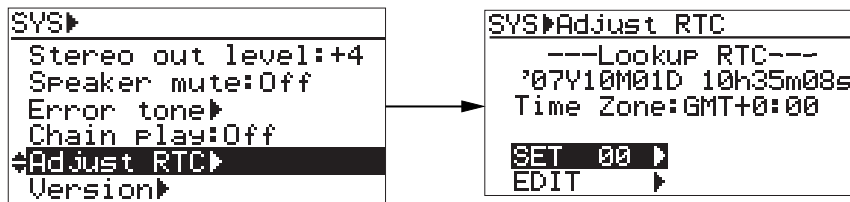

By pressing the [ENTER/YES] key while "SET "00s":" is highlighted (as the screen shown above right), the second field is reset to "00". If you reset the second field when the second value is 30 or more, the minute field value is incremented. If you reset the second field when the second value is less than 30, only the second field is reset.

- 4) Use the [MENU] dial to select "EDIT" and press the [ENTER/YES] key. The clock data at the moment when you press the [ENTER/YES] key is held and you can now edit it (the second field flashes).

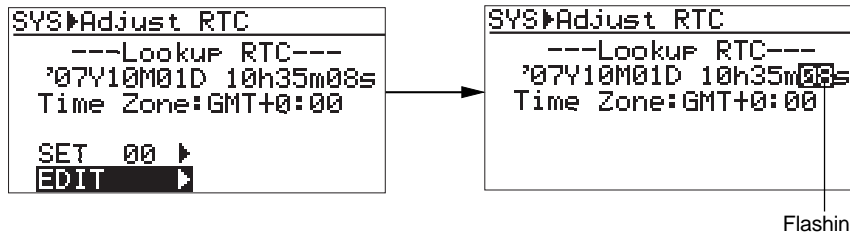

- 5) Enter the desired date/time data. Use the [MENU] dial (or the alphanumeric keys) to enter a desired value to the current cursor position (flashing field). You can move the cursor position using the [◀◀] and [▶▶] keys.

- 6) After entering date/time data, move the cursor to the offset time value (by default, "+0:00") of Time Zone, and enter the desired offset time according to the country where the unit is used.

By rotating the [MENU] dial, you can select the desired offset time within the range between -12:00 and +13:00.

Example: London: +0:00, Tokyo: +9:00, Los Angels: -8:00 (-7:00)

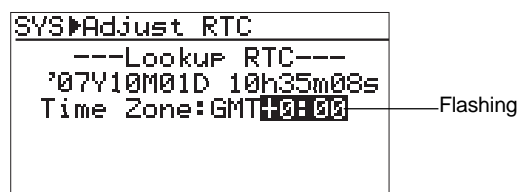

- 7) After entering all data, press the [ENTER/YES] key to start running the clock.

<Note>: We recommend entering a time shortly ahead of "now" (such as one minute ahead) in step 5 above and pressing the [ENTER/YES] key (in step 7 above) at the moment when the current time reaches the entered time.

- 8) Press the [EXIT] key repeatedly to exit the MENU mode.

Preparation of a DVD-RAM disk

The internal DVD multi drive of the PD204 features a slim drive and accepts a non-cartridge DVD-RAM disk (4.7GB, 2-3 x or more than 3x). An unused DVD-RAM disk must be formatted in UDF 1.5.

Inserting a disk

The following procedure assumes that partition 1 (PT01) which has no recorded file is currently selected.

1) Slide the [OPEN] lever to the right.

The cover of the disk tray opens a little, so you can open the cover by hand.

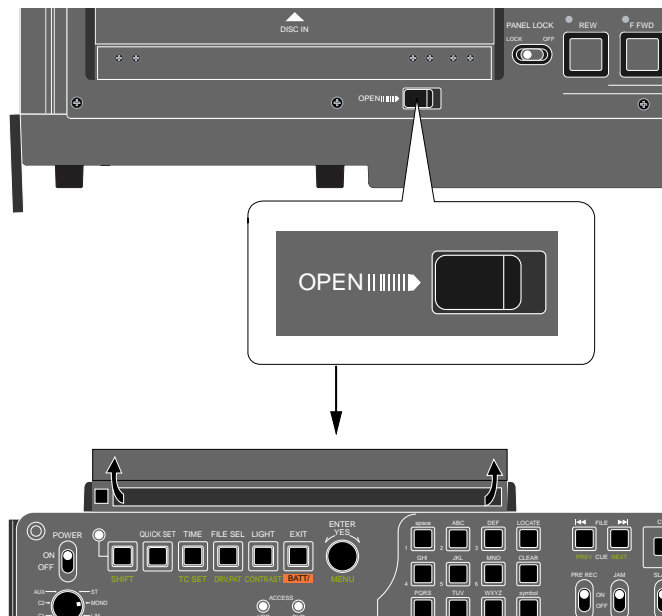

2) Insert a disk to the drive slot.

The unit loads the disk and reads the disk information.

When the unit is shipped from the factory, the current drive is set to the internal hard disk drive, so the display shows the Home screen for partition 1. Therefore, the screen does not change when loading a DVD-RAM disk.

To eject the disk, press the eject button located at the left of the slot.

<Note>: Do not eject a DVD disk from the disk tray while the current drive is set to the DVD drive and the disk is running. Before you eject the disk, make sure that the disk is stopped (the [PAUSE] indicator is unlit). Also note that it takes some time to eject the disk. Do not press the [PLAY], [F. FWD] or [REW] key.

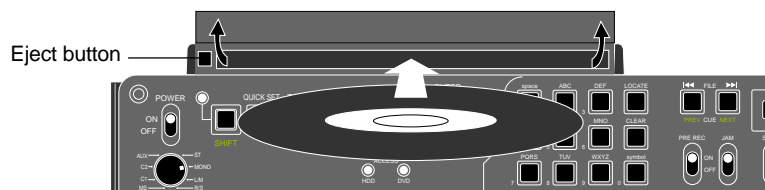

3) Close the tray cover until locked by hand.

Now you can format the DVD-RAM disk by following the procedure described on the next page.

Initial format of a DVD-RAM disk

- 1) While the unit is stopped, press the [SHIFT] key to enter shift mode, followed by the [ENTER/YES] key.
The unit enters MENU mode and brings up the MENU list screen for selecting the desired main menu.

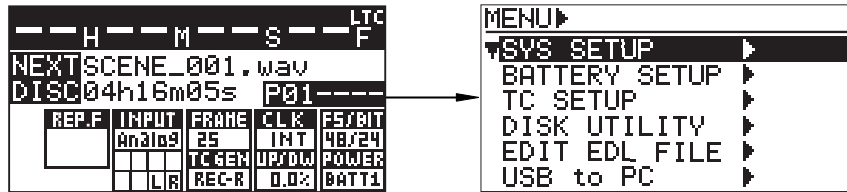

- 2) Use the [MENU] dial to select "DISK UTILITY" and press the [ENTER/YES] key.
The display shows the DISK UTILITY menu screen, on which you can select disk utility menu item.

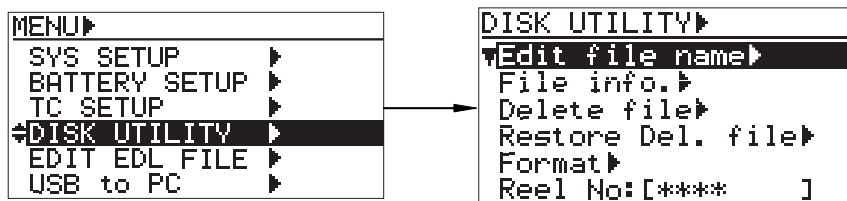

- 3) Use the [MENU] dial to select "Format" and press the [ENTER/YES] key.
The display now shows the screen for formatting.

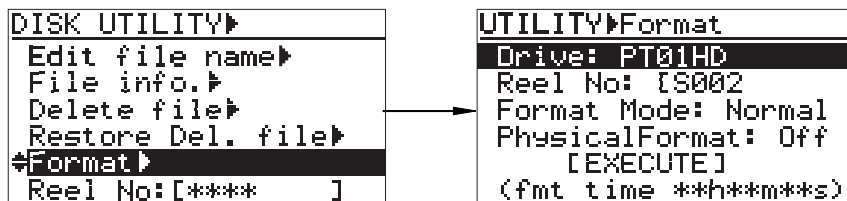

On this screen, you can make the following four settings.
This procedure example assumes that the "Reel No" and "Physical Format" items are left as default.

Drive	Selects the drive to be formatted. You can select "DVD-RAM" or any of the hard disk partitions ("PT01HD" through "PT16HD").
Reel No	Sets the reel number for the DVD-RAM disk or partition to be formatted. The default reel numbers for a DVD-RAM disk and partitions are as follows. DVD-RAM: S001 Partitions: S002 through S017 You can change the reel number later via the "Reel No" item in the "DISK UTILITY" menu of the MENU mode (see page 202).
Format Mode	Selects the format mode. When you format a DVD-RAM disk, only "Normal" is available. When you format a partition, "Normal" and "DDR" are available. The "DDR" option is used when executing dual drive recording described later (see page 113).
Physical Format	Selects whether or not you physically format a DVD-RAM disk or partition. When selecting "Off", a quick format is performed. When selecting "On", a physical format is performed, which takes longer time (see <Note> on the next page).

<Note>: When formatting a well-used DVD-RAM disk, perform the physical format. The following shows the approximate required time for formatting a 4.7GB DVD-RAM disk.

When "Physical Format" is set to "Off": approx. 1 min. 30 sec.
 When "Physical Format" is set to "On": approx. 1 hour 30 min.

- 4) Press the [ENTER/YES] key.
 You can now select the drive.

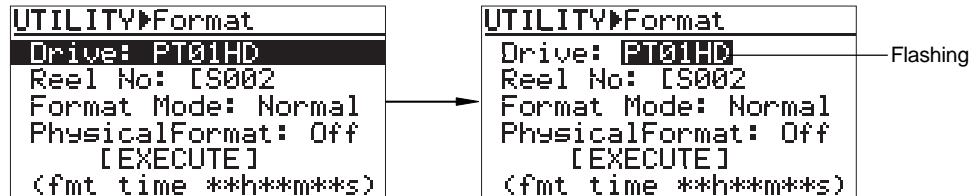

- 5) Use the [MENU] dial to select "DVD-RAM" and press the [ENTER/YES] key.
 The drive selection is confirmed and "Reel No: [S001" is highlighted.

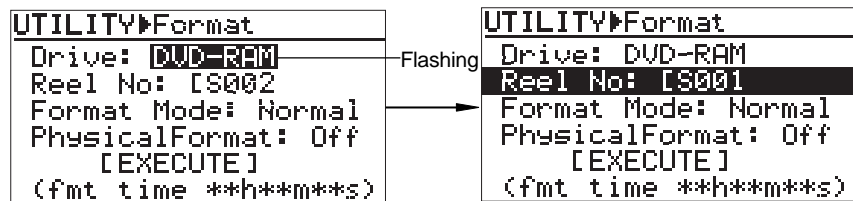

For the operation of setting the desired reel number on this screen, see the next page. Also, you can set the desired reel number after formatting via the "Reel No" item in the "DISK UTILITY" menu of the MENU mode (see page 202).

- 6) Use the [MENU] dial to highlight "[EXECUTE]" and press the [ENTER/YES] key.
 The display shows the caution screen, where "Are you sure?" flashes.

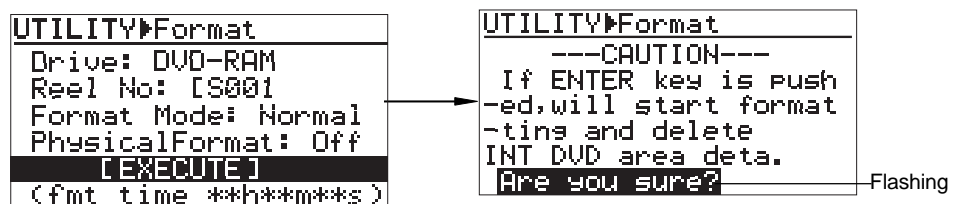

- 7) While "Are you sure?" flashes, press the [ENTER/YES] key.
 The unit starts formatting.
 The display shows the formatting countdown, as well as the progress status by the bar-graph meter. When formatting completes, the display shows "Fmt. Completed!"

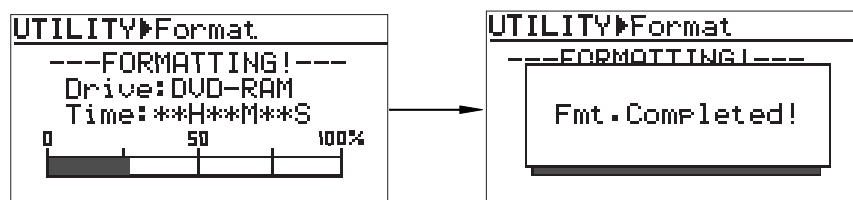

<Note>: Note that the formatting countdown and bar-graph meter show the approximate information. Do not proceed to the next step until "Fmt. Completed!" is shown.

<Note>: In rare cases, the unit shows "Disk error!" and releases the disk lock after formatting is performed. In such a case, set "Physical Format" to "On" and format the disk again. If "Disk error!" is shown again after the physical format is performed, do not use the disk.

8) After formatting, press the [EXIT] key to exit the MENU mode.

The display returns to the Home screen previously shown before entering the MENU mode.

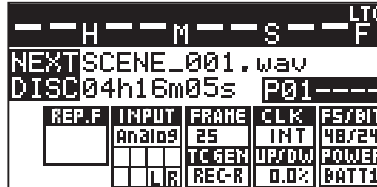

To make recording to the DVD-RAM disk, select the current drive to the DVD drive (see page 84 for details).

<Note>: If you format a DVD-RAM disk when any partition is selected as the current drive, the current drive does not change after formatting is completed. Therefore, if you want to make recording to the DVD-RAM disk, you must change the current drive from the partition to the DVD drive. On the other hand, if you format a partition when the DVD drive is selected as the current drive, the current drive automatically changes to the partition after formatting is completed.

How to set the desired reel number

During the process of initial formatting, you can set the desired reel number by the following procedure.

1) While "Reel No: [S001]" is highlighted, press the [ENTER/YES] key.

The first digit of the reel number field starts flashing. You are ready for editing the reel number.

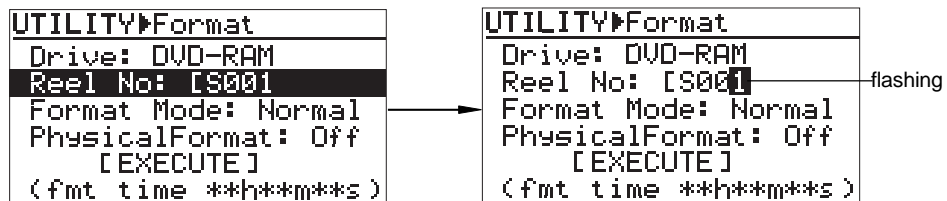

2) Use the [MENU] dial (or the alphanumeric keys) to enter the desired reel number.

Use the [◀] and [▶] keys to move the cursor position when entering the number using the [MENU] dial.

When using the alphanumeric keys for entering characters, pressing any other alphanumeric key moves the cursor to the right automatically.

Pressing the [CLEAR] key clears the character at the cursor position.

3) After editing the reel number, press the [ENTER/YES] key to confirm your setting.

Replacing the internal hard disk drive

You can replace the internal hard disk drive with the optional Model EX-HD1 hard disk drive by following the procedure below.

<Note>: Before you replace the hard disk drive, turn off the power and remove the AC adaptor (or battery). Handle the optional and internal hard disk drives gently and carefully because they contain precision parts.

<Note>: When you use the unit vertically with the front panel down, put the unit on a soft fabric, etc. and fix the unit so that it does not fall down.

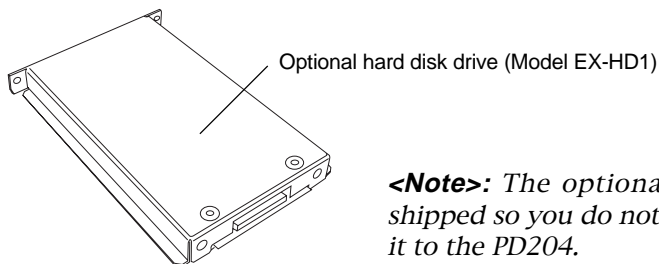

<Note>: The optional hard disk is formatted when shipped so you do not have to format it after mounting it to the PD204.

- 1) Loosen the four fixed screws around battery mount 1 and remove the panel.**
The internal hard disk drive appears as indicated in the figure below.

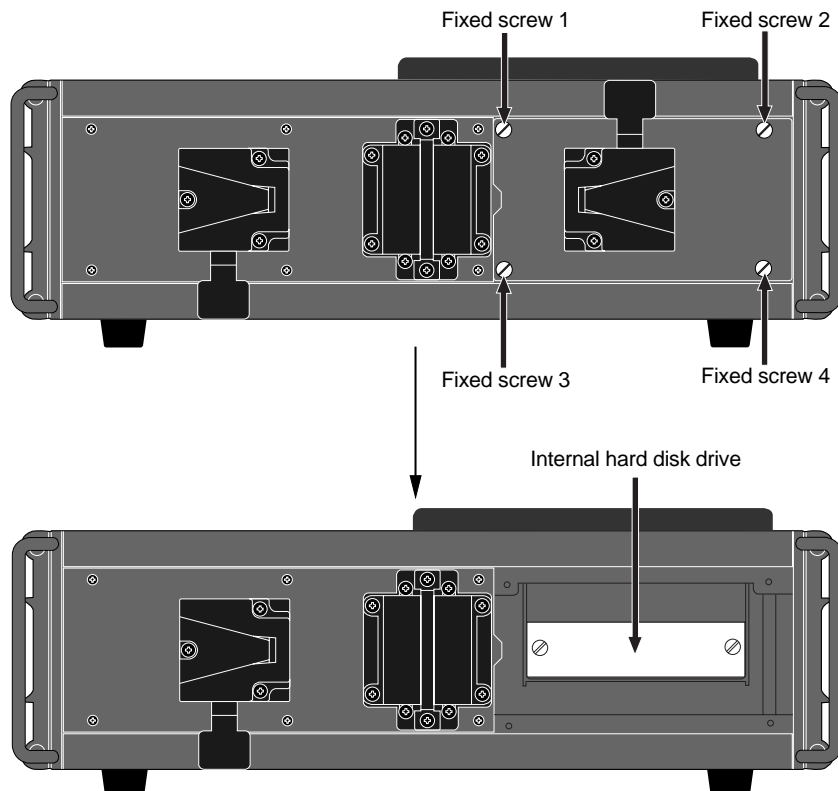

- 2) Loosen the two fixed screws which fix the hard disk drive and remove the hard disk drive.**
The fixed screws are not removed. Grip the screw heads by fingers and pull out the hard disk drive. The drive is connected to the connector inside so take great care for pulling it out.

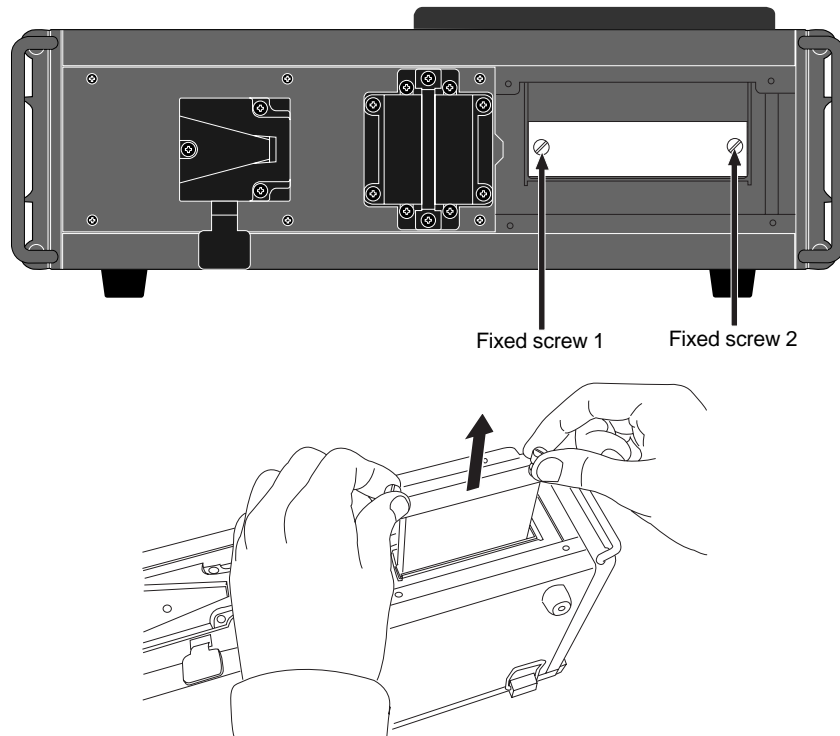

After removing the hard disk drive, you can see the connector inside for connecting with the hard disk drive.

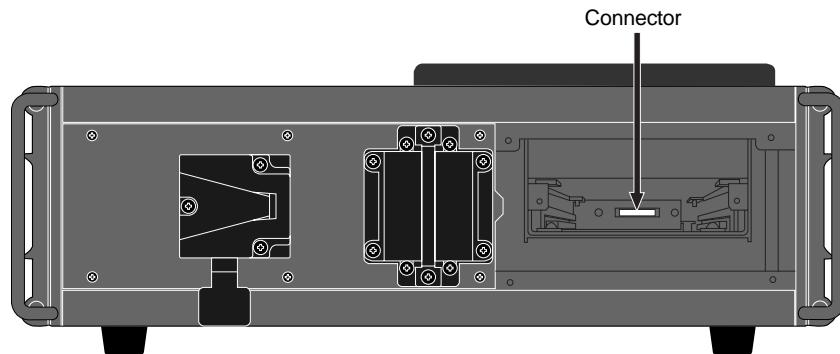

- 3) **Insert the optional hard disk drive to the slot.**
Insert the drive into the slot until it is fully inserted to the connector inside, and fix it with two screws.

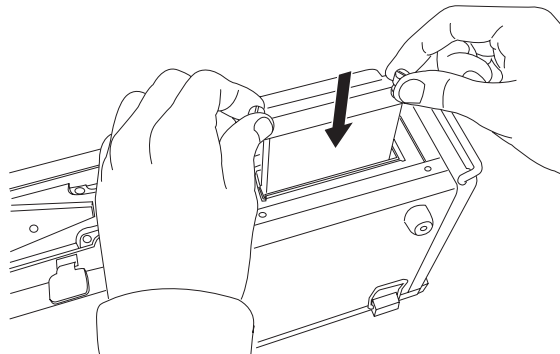

- 4) **Cover the slot with the panel and fix it with four screws.**
Now you finish hard disk drive replacement.

Chapter 3: Names and Functions

Chapter 3 - Table of contents

Left side panel	40
Right side panel	42
Front panel	45
Top panel	53
Rear panel	55
LCD display details	56

Left side panel (inputs/outputs)

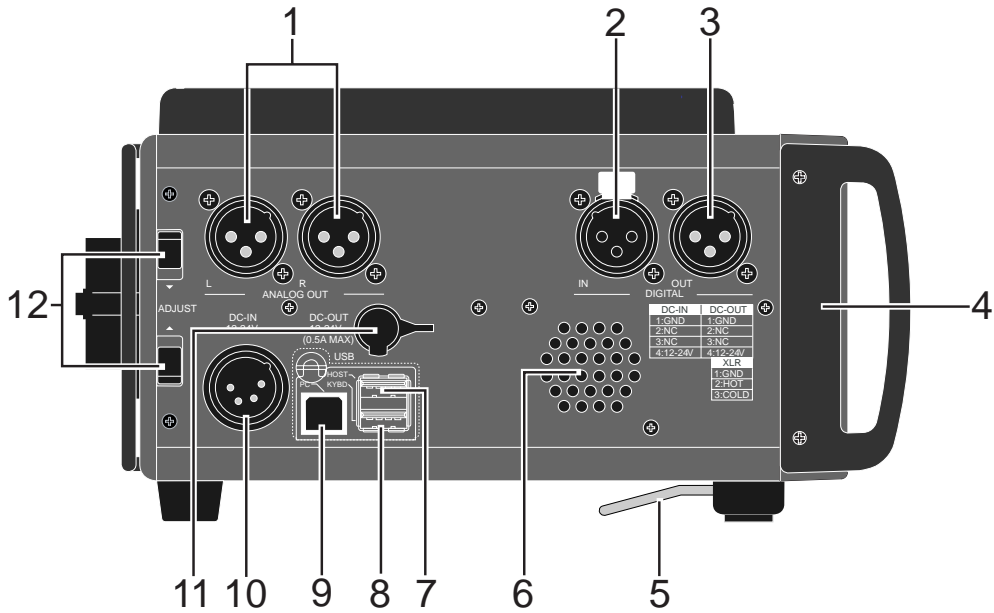

- [ANALOG OUT (L, R)] connectors (XLR-3-32 type/balanced)**
 Outputs the stereo tracks L/R signals. It is used to connect to an external audio device. The reference level is set to +4dBu by default but you can change it to -10dBu or -60dBu using the "Stereo out level" menu item in the "SYS SETUP" menu of the MENU mode (see page 158).

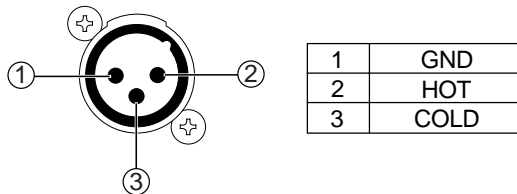

- [DIGITAL IN] connector (XLR-3-31 type/balanced)**
 This connector receive AES/EBU or S/P DIF digital signals. It automatically detects the digital audio input format (AES/EBU or S/P DIF).

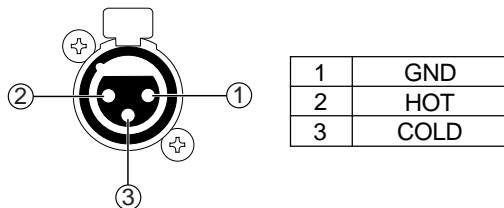

- [DIGITAL OUT] connector (XLR-3-32 type/balanced)**
 This connector sends AES/EBU or S/P DIF digital signals. The digital output signal format (AES/EBU or S/P DIF) can be set by the "Digital out" menu item in the "SYS SETUP" menu of the MENU mode (see page 144).

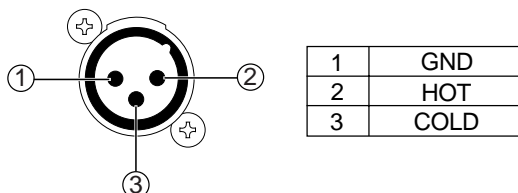

4. **Handle**
Used to fix the supplied shoulder belt.

5. **Angle adjustment arm**
Used to adjust the angle of the unit when you use it on a desk.

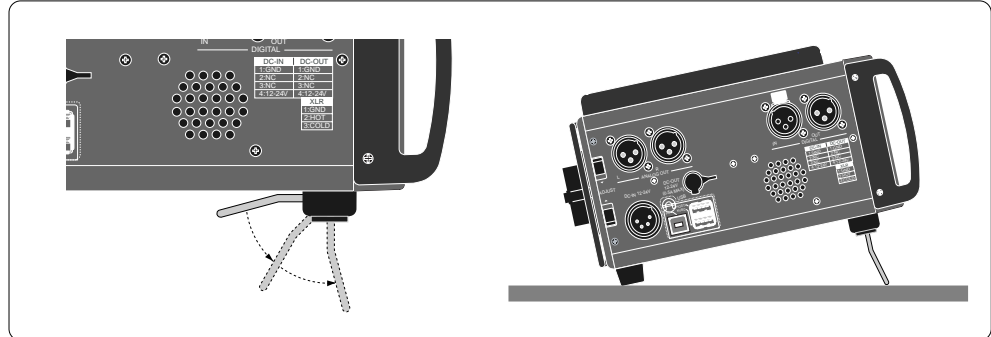

6. **Internal monitor speaker**
Outputs audio signals of tracks L and R, error tones, etc.
When a headphones plug is inserted to the [PHONES] jack, the monitor speaker is inactive.

7. **[USB HOST] connector (Series A Receptacle/USB 2.0 High speed)**
Not currently supported. Prepared for the future expansion.

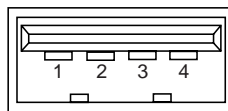

1	VBUS
2	D -
3	D +
4	GND

<Note>: When you connect the PD204 to a personal computer using the [USB PC] connector, do not connect any device to the [USB HOST] connector.

8. **[USB KYBD] connector (Series A Receptacle/USB 1.1)**
Used to connect to a USB keyboard. You can control the PD204 from the keyboard (see “Connection examples of a keyboard” on page 66).

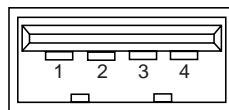

1	VBUS
2	D -
3	D +
4	GND

9. **[USB PC] connector (Series B Receptacle)**
Used to connect to a personal computer. You can transfer audio files between the PD204 and your personal computer (see pages 68 and 116).

<Note>: When you connect the PD204 to a personal computer using the [USB PC] connector, do not connect any device to the [USB HOST] connector.

10. **[DC IN 12-24V] connector (XLR-4-32 type/male)**
Connects the optional AC adaptor or an external battery.

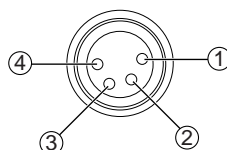

1	GND
2	NC
3	NC
4	12-24V

11. **[DC OUT] connectors (Hirose 4-pin, HR10A-7R-4S type/female)**
Outputs DC 12 V/0.5 A power. You can supply power to an external device.

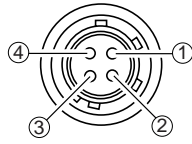

1	GND
2	NC
3	NC
4	12-24V

12. **[ADJUST] lever**
Used to adjust the protector on the left of the rear panel (see page 25).

Right side panel

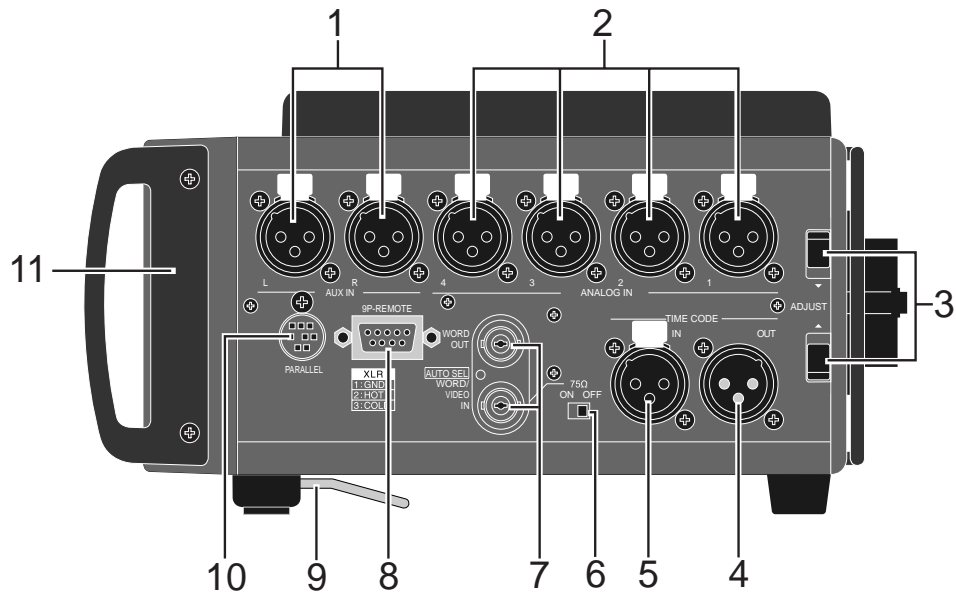

1. **[AUX IN (L, R)] connectors (XLR-3-31 type/balanced)**
These connectors receive analog audio signals from the external device.

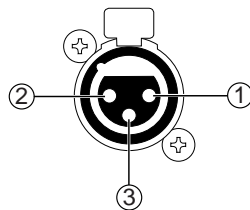

1	GND
2	HOT
3	COLD

2. **[ANALOG IN (1 ~ 4)] connectors (XLR-3-31 type/balanced)**
These connector receive analog audio signals (mic or line level), which can be sources of channels 1 through 4.

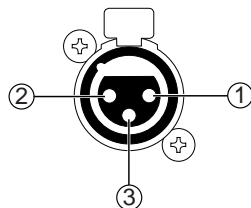

1	GND
2	HOT
3	COLD

3. **[ADJUST] lever**
Used to adjust the protector on the right of the rear panel (see page 25).

4. **[TIME CODE OUT] connector (XLR-3-32 type/balanced)**
Outputs time code.

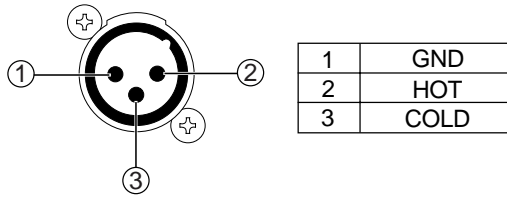

5. **[TIME CODE IN] connector (XLR-3-31 type/balanced)**
Inputs external time code.

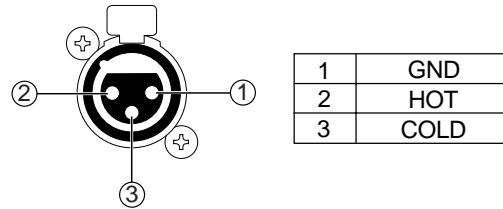

6. **[WORD IN] termination switch**
Terminates the word input signal by setting the switch to "ON".
7. **[WORD/VIDEO IN] and [WORD OUT] connectors (BNC type)**
The [WORD/VIDEO IN] connector receives word or video clock. It automatically detects the clock type (word or video).
The [WORD OUT] connector feeds a word clock.
8. **[9P-REMOTE] connector (D-sub 9-pin/female)**
Not currently supported. Prepared for the future expansion.
9. **Angle adjustment arm**
10. **[PARALLEL] connector (MINI DIN 8-pin)**
This connector accepts parallel remote signals for controlling the PD204 externally.

You can control the following nine operations remotely.

1	PLAY	6	CUE point registration
2	STOP	7	PAUSE
3	RECORD	8	FILE ◀◀
4	REWIND	9	FILE ▶▶
5	F. FORWARD		

<Operation>

When each terminal is grounded, the corresponding function is active.
Note that you can always control the PD204 via this connector regardless of the setting of the [PANEL LOCK] key on the panel.

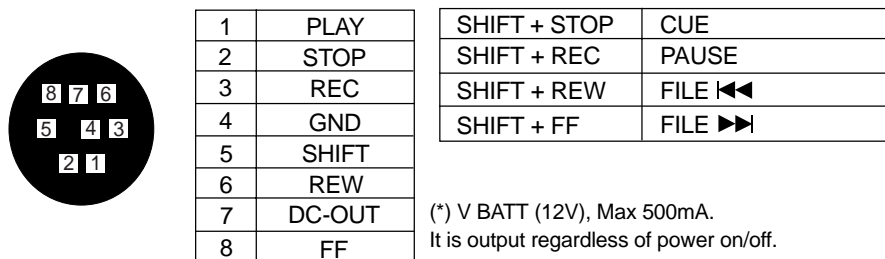

(*) V BATT (12V), Max 500mA.
It is output regardless of power on/off.

<Caution>: Pin 7 (DC-12V) is supplied from the PD204.
 If it is short-circuited to GND or used with a heavy load, the PD204 internal battery life may be exhausted faster or the PD204 may generate heat abnormally. Be careful not to use it with a heavy load or short-circuit it to GND.

11. **Handle**
 Used to fix the supplied shoulder belt.

Front panel

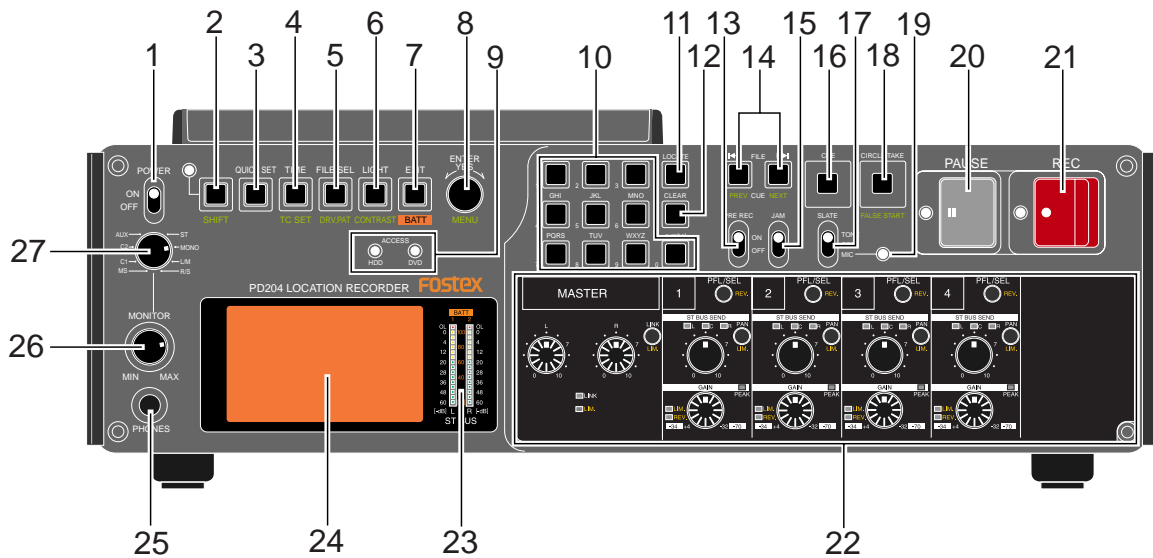

1. **[POWER] switch**
 Turns on or off the main power of the PD204.
 To prevent pressing the switch by accident, it is located in the depressed area on the panel .

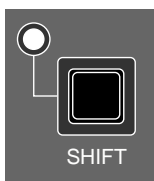

2. **[SHIFT] key/indicator**
 Pressing this key turns the shift mode on or off. When on, the indicator is lit and you can execute a SHIFTEd (secondary) function of a key which has dual functions. The SHIFTEd function of a key (if available) is labeled under the key.

<Note>: When the shift mode is on, pressing any key which has a shifted function executes the shifted function and turns off the shift mode.

About Non-shift mode and Shift mode

Some keys have the secondary function which is available when the SHIFT indicator is lit (i.e. in the Shift mode), while the primary function is available when the SHIFT indicator is unlit (i.e. in the Non-shift mode). In this manual, we sometimes say "when SHIFTEd" and "when unSHIFTEd", instead of "when the SHIFT indicator is lit" (or "in the Shift mode") and "when the SHIFT indicator is unlit" (or "in the Non-shift mode") respectively.

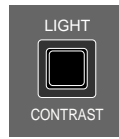

<Example of a key with a SHIFTed function>

For example, the [LIGHT/CONTRAST] key as shown on the left has the secondary (SHIFTed) function which is labeled under the key. When "unSHIFTed", pressing this key turn on the backlight of the display. When "SHIFTed", pressing this key adjusts the display contrast.

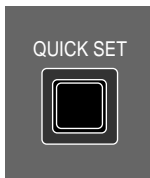

3. [QUICK SET] key

Pressing this key enters the quick setup mode. In this mode, you can directly select the setting items shown in the status indication area on the Home screen (see page 74 for details).

To cancel the quick setup mode, press the [EXIT] key.

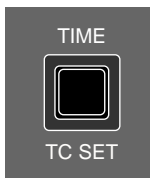

4. [TIME / TC SET] key

This key has primary (unSHIFTed) and secondary (SHIFTed) functions.

• **When unSHIFTed:**

Selects the time display mode on the display from ABS, LTC, TC IN and GEN (see page 56).

• **When SHIFTed:**

Brings up the TC SETUP menu screen, on which you can make the necessary settings for recording and playing back time code (see page 174).

To exit the TC SETUP menu, press the [EXIT] key.



5. [FILE SEL / DRV, PAT] key

This key has primary (unSHIFTed) and secondary (SHIFTed) functions.

• **When unSHIFTed:**

Brings up the screen for selecting an audio file from the files recorded on the current disk (or a hard disk partition) (see page 96). You can select a file by highlighting the desired file using the [MENU] dial and pressing the [ENTER/YES] key.

• **When SHIFTed:**

Brings up the screen for selecting the active drive for recording/playback (see page 84). To exit the mode, press the [EXIT] key.

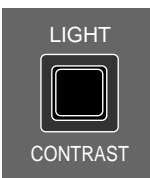

6. [LIGHT / CONTRAST] key

This key has primary (unSHIFTed) and secondary (SHIFTed) functions.

• **When unSHIFTed:**

Turns on or off the backlight of the display (see page 30).

Pressing this key turns on the backlight of the display, which is automatically turned off after three seconds. If you keep holding down this key for more than three seconds, the backlight keeps on lighting until you press this key again.

• **When SHIFTed:**

By pressing this key, you can bring up the screen for adjusting the display contrast using the [MENU] dial (see page 30).

After adjusting the contrast, pressing the [ENTER/YES] key confirms the setting.



7. **[EXIT / BATT] key**
 Used to cancel an edit operation or execution, as well as used to exit the MENU mode.
 While the Home screen is shown, pressing and holding down this key switches the screen to show the battery remaining condition instead of the stereo bus bar-graph meters (see page 26).

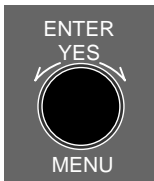

8. **[MENU]/[LINK MASTER] dial / [ENTER/YES] key**
 You can rotate or press this knob. This knob has two main functions.
- **[MENU] dial function:**
 In the MENU or editing mode, rotating this knob selects an item, option, alphanumeric character, etc.
 - **[ENTER/YES] key function.**
 When unSHIFTed, pressing this knob confirms the setting or executes a function. When SHIFTed, pressing this knob brings up the main menu screen.

<Note>: In this manual, we describe this knob as the [MENU] dial or [ENTER/YES] key, depending on the function used.



9. **[ACCESS] indicator (HDD, DVD)**
 Each indicator Indicates the access condition of the internal hard disk drive or the DVD-RAM drive.
 Each indicator lights in green while the corresponding drive is not accessed, in orange while it is accessed for reading, and in red while it is accessed for writing.
- * When no disk is set to the DVD-RAM drive, the "DVD" indicator is unlit.**

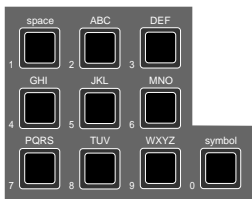

10. **Alphanumeric keys**
 While the display shows the Home screen, pressing any of the alphanumeric keys enters the time data edit mode. After editing time data, you can locate to the edited time position by pressing the [LOCATE] key (see page 101). While the unit is in any of the edit modes, you can enter time data or name.
- <Key example>:** Using the "3" key, you can enter "d", "e", "f", "D", "E" and "F", as well as "3".

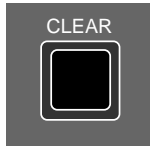

11. **[LOCATE] key**
 Locates to the desired position in the following manners.
- While a cue point is selected, pressing the key locates to the selected cue point (see page 102).
 - While time data is being edited, pressing the key locates to the edited time position (see page 101).
 - While the display shows the Home screen, pressing the key locates to the point previously located to (the default setting is "ABS 0")(see page 100).

**12. [CLEAR] key**

Pressing this key functions in the following manners.

- **While entering characters:**

Erases the next character on the right of the cursor position.

- **While editing time data:**

Clears time data and sets it to "00h 00m 00f 00sf".

- **While the "Peak hold" setting menu in the Setup mode is set to "∞":**

Resets the peak level indication on the level meters.

- **While a warning popup window is shown:**

Dismisses the popup window.

**13. [PRE REC] switch**

When this switch is set to "ON", recording starts from audio data stored in the buffer (see page 87). The buffered time can be set using the "Pre rec time" menu item in the "SYS SETUP" menu of the MENU mode (see page 151).

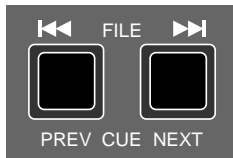
**14. [◀◀ / PREV] and [▶▶ / NEXT] keys**

These keys have primary (unSHIFTed) and secondary (SHIFTed) functions.

- **When unSHIFTed:**

- Pressing the [◀◀ / PREV] or [▶▶ / NEXT] key skips to "ABS 0" of the previous or next audio file. You can skip to "ABS 0" of the desired audio file by pressing the appropriate key as many times as required.

- While editing time or a label in the edit mode, pressing the [◀◀ / PREV] or [▶▶ / NEXT] key moves the cursor to right or left.

- **When SHIFTed:**

Pressing the [◀◀ / PREV] or [▶▶ / NEXT] key skips to the previous or next cue point. You can skip to the desired cue point by pressing the appropriate key as many times as required.

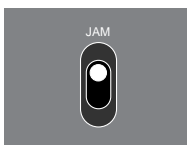
**15. [JAM] switch**

Used to execute the jamming function (see page 92).

When this switch is set to "ON" and the PD204 is receiving external time code, the internal time code generator takes over (jams) time code.

Note that the jamming function is only available when the TC generator mode is set to "Free Run". Depending on the setting of the "JAM mode" menu item in the TC SETUP menu of the MENU mode, the PD204 also jams the time code user bits (see page 182).

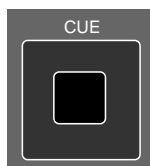
**16. [CUE] key**

This key functions as follows depending on the recorder condition.

- **During recording:**

By pressing this key during recording, the current position data is stored as a cue point "on the fly". The data is entered into the next available cue point (see page 93).

- **In any condition except during recording:**

Pressing this key brings up the cue point list. While the cue point list is shown, you can check the cue points which hold data, as well as can locate to the desired cue point, edit the cue point data and performs cue point entry (see page 93).

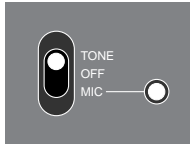

17. [SLATE] (TONE, OFF, MIC) switch

While you slide up and holding the switch knob to the “TONE” position, the slate tone is output. While sliding down and hold the knob to the “MIC” position, the internal slate microphone is active (see page 88).

TONE	While sliding up and hold the switch knob to the “TONE” position, the slate tone (at 1 kHz, reference level) is fed to all channels and the stereo bus. During recording, you can record the slate tone. <Note>: If you slide up and hold the switch knob to the “TONE” position for more than three seconds, the slate tone is continuously output even after you release the switch knob. Sliding up the knob to the “TONE” position stops slate tone output.
MIC	While sliding down and holding the switch knob to the “MIC” position, the slate microphone signal is fed to all channels and the stereo bus. During recording, you can record the slate microphone signal.

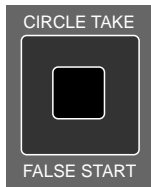

18. [CIRCLE TAKE / FALSE START] key

This key has primary (unSHIFTed) and secondary (SHIFTed) functions.

• **When unSHIFTed:**

Adds "@" to the beginning of the name of the current audio file. If the name of the current audio file already has "@" at the beginning, pressing this key deletes "@" (see page 126).

• **When SHIFTed:**

Pressing this key after making recording cancels the recording (False start function) (see page 86). You can select whether the canceled file is stored to or deleted from the disk (or partition) using the "False start" item in the "SYS SETUP" menu of the MENU mode (see page 155).

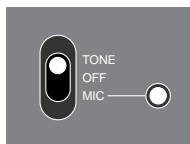

19. Slate microphone

This internal slate microphone is active while you slide and hold the [SLATE] switch knob to the "MIC" position. The protection circuit (AGC) is provided for protecting against excessive input (see page 88).

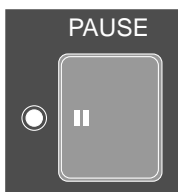

20. [PAUSE] key/indicator (green)

Pressing this key enters the recorder to the standby mode and lights up the indicator. Only this key can stop recording.

You cannot stop recording with any other key. You can set the pause release time using the "Pause time" menu in the SYS SETUP menu of the MENU mode (see page 149).

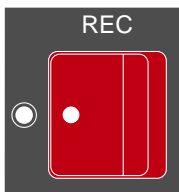

21. [REC] key/indicator (red)

Pulling this key to the right starts recording.

Depending on the "PRE REC mode" setting (on or off), it works as follows.

• **When recording with the PRE REC mode set to "OFF":**

By pulling this key, the PD204 automatically creates a new file to the current disk (or a partition) and starts recording audio and time code. It also records the offset between time code and ABS one second after recording starts.

• **When recording with the PRE REC mode set to "ON":**

Pulling this key starts recording from the audio data stored in the buffer. The offset between the time code and ABS time values after a second from the beginning of recording is also recorded.

You can select the buffered time between 1 and 10 seconds using the "Pre rec time" menu item in the SYS SETUP menu of the MENU mode (the default setting is 10 seconds) (see page 151).

<Note>: The time code recorded is conformed to the setting done by the quick setup mode or the "TC GEN" item in the "TC SETUP" menu of the MENU mode. See pages 76 and 177 for details about the "TC GEN" item.

22. Mixer section

The mixer section allows you to mix signals from inputs 1 through 4 and send the mixed signals to the stereo bus.

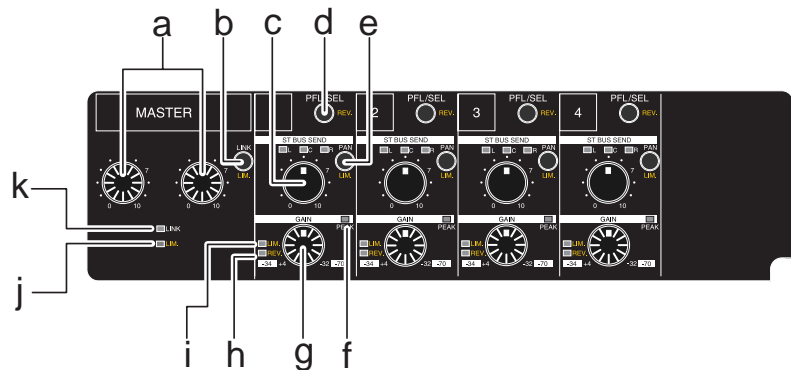

a. The [MASTER (L, R)] controls

Controls the master level of the signals sent to the stereo bus. Each control adjusts the master level of the signal sent to the L or R channel or the stereo bus.

The [MASTER (L, R)] controls can be linked by pressing the [MASTER LINK] key. When linked, the L control adjusts the master level of both L and R channels (see page 82).

b. [MASTER LINK] key

This key has the primary (unSHIFTed) and secondary (SHIFTed) functions.

• **When unSHIFTed:**

Enables or disables the link function of the [MASTER (L, R)] control. When the link function is enabled, the "LINK" indicator under the [MASTER] controls is lit, while it is unlit when the function is disabled (see page 83).

• **When SHIFTed:**

Switches on/off of the stereo bus limiter (see page 79).

When it is on, the [LIM.] indicator below the [MASTER (L, R)] controls is lit. When the limiter is working, the indicator quickly flashes.

You can set the limiter parameter using the "Limiter parameter" item in the "SYS SETUP" menu of the MENU mode (see page 156).

c. [ST BUS SEND] control

Controls the channel send level to the stereo bus (see page 82).

- d. **[PFL/SEL] key**
This key has primary (unSHIFTed) and secondary (SHIFTed) functions.
- **When unSHIFTed:**
While pressing down the [PFL/SEL] key(s) for the desired channel(s), you can monitor the pre-fader signal(s) of the channel(s) (see page 83). Switches on/off of PFL (Pre Fader Listen) for each channel (1 through 4).
 - **When SHIFTed:**
You can reverse the input phase of each channel. When reversed, the [REV.] indicator left the [GAIN] control is lit (see page 82).
- e. **[PAN] key**
This key has primary (unSHIFTed) and secondary (SHIFTed) functions.
- **When unSHIFTed:**
Selects the pan mode for sending the channel signal to the stereo bus. Each press of the key switches among three modes: "L" (left), "C" (center), "OFF" and "R" (right). The indicator of the selected pan mode is lit (see page 82).
 - **When SHIFTed:**
Switches on/off of the limiter of the corresponding channel (see page 79). When it is on, the [LIM.] indicator left the [GAIN] control is lit. When the limiter is working, the indicator quickly flashes. You can set the limiter parameter using the "Limiter parameter" item in the "SYS SETUP" menu of the MENU mode (see page 156).
- f. **[PEAK] indicator**
Lights or flashes in red when the input signal reaches the peak level.
- g. **[GAIN] control**
Controls the channel input gain. Depending on the setting of the [INPUT SEL] switch on the top panel, you can control the gain within the following ranges (see page 80).
- **When the [INPUT SEL] switch is set to "LINE":** +4dBu to -32dBu
 - **When the [INPUT SEL] switch is set to "MIC":** -34dBu to -70dBu
- h. **[REV.] indicator**
Lights up when the phase of each input channel is reversed. You can reverse the phase by pressing the [SHIFT] key followed by the [PFL/SEL] key.
- i. **[LIM.] indicator**
Flashes when the limiter function of each input channel is enabled and lights up when the limiter function is active. You can enable or disable the limiter function by pressing the [SHIFT] key followed by the [PAN] key.
- j. **[MASTER LIM.] indicator**
Flashes when the limiter function of the stereo bus is enabled and lights up when the limiter function is active. You can enable or disable the limiter function by pressing the [SHIFT] key followed by the [MASTER LINK] key.
- k. **[MASTER LINK] indicator**
Lights up when the [MASTER (L, R)] controls are linked. You can link or unlink the controls by pressing the [MASTER LINK] key.

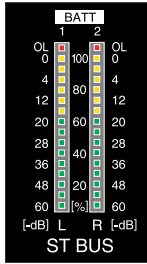

23. ST BUS bargraph meters

Indicates the input or output levels of the stereo bus (L and R) or battery remaining (see page 26). The display mode can be selected by the [EXIT/BATT] key.

24. LCD display

Displays information for time, file, settings, etc. (see page 55).

25. [PHONES] jack

Connects headphones.

Inserting a plug automatically disables the internal monitor speaker.

26. [MONITOR] control

Controls the monitor level of headphones (or the internal speaker).

At the leftmost position, monitoring is completely switched off.

This control can be pushed-lock. Pressing the control puts it down to the panel height level. Pressing it again releases it.

27. Monitor select dial

Selects the tracks/inputs to be monitored (see the table below).

	Record	Playback
ST	L: BUS L, R: BUS R	L: ST L, R: ST R
MONO	BUS L+R (MONO)	ST L+R (MONO)
L/M	BUS L (MONO)	ST L (MONO)
R/S	BUS R (MONO)	ST R (MONO)
M/S	L: BUS MS L, R: BUS MS R	L: ST MS L, R: ST MS R
C1	For the future expansion. No monitor signal is assigned on this version.	
C2	For the future expansion. No monitor signal is assigned on this version.	
AUX	L: AUX L, R: AUX R	L: AUX L, R: AUX R

Top panel

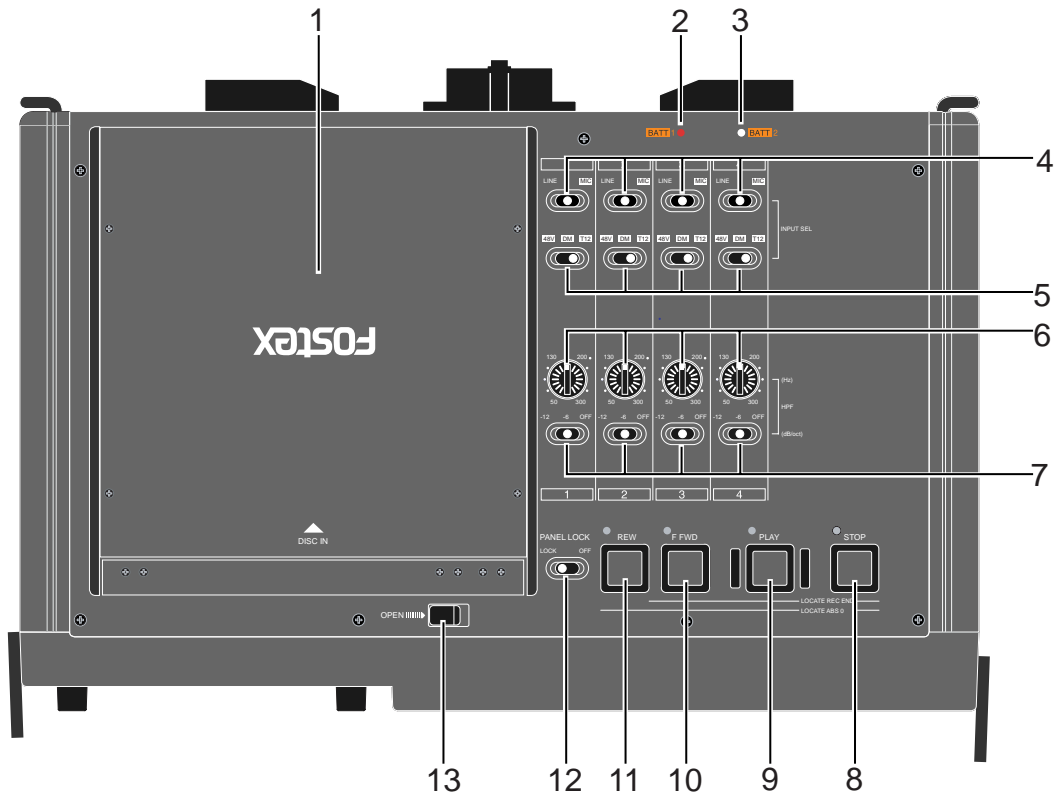

1. **Disk tray**
Sets a DVD disk.
To set a disk, use the [OPEN] lever to release the lock of the protection cover, and open the disk tray (see page 33 for details).

<Note>: Do not eject a DVD disk from the disk tray while the current drive is set to the DVD drive and the disk is running. Before you eject the disk, make sure that the disk is stopped (the [PAUSE] indicator is unlit). Also note that it takes some time to eject the disk. Do not press the [PLAY], [F FWD] or [REW] key.

2. **[BATT1] indicator**
Lights up when the battery mounted to battery mount 1 is supplying the power (see page 29 for details).
3. **[BATT2] indicator**
Lights up when the battery mounted to battery mount 2 is supplying the power (see page 29 for details).
4. **[INPUT SEL] switches**
Each switch selects the input gain (LINE or MIC). Set it appropriately according to the analog audio input source of the corresponding channel (see page 79 for details).

5. Microphone power supply switches

You should set each switch to the appropriate position depending on the microphone connected to the corresponding input (see page 79).

DM	No power is supplied. (For a dynamic microphone)
48V	48 V phantom power is supplied.
T12	12 V A-B power (T12) is supplied.

6. [HPF] frequency controls

Each control adjusts the cutoff frequency of the high pass filter for the corresponding input (see page 79).

The adjustable range is from 50 Hz to 300 Hz.

7. [HPF] switches

Each switch selects the high pass filter response from the followings (see page 80).

OFF, -6 dB/oct. and -12 dB/oct.

8. [STOP] key/indicator (green)

Stops the recorder, as well as stops the disk rotation.

<Note>: While operating the unit on battery, we recommend using the [STOP] key to stop the disk rotation for saving battery power.

By pressing the [REW] or [F FWD] key while holding down the [STOP] key, the following operation is possible.

[STOP] + [REW]	Moves the recorder to the beginning (ABS 0) of the current file.
[STOP] + [F FWD]	Moves the recorder to the recording end (REC END) of the current file.

9. [PLAY] key/indicator (green)

Starts playback.

10. [F FWD] key/indicator (green)

Pressing this key while stopped fast-forwards the recorder at maximum 30 x speed.

Pressing this key during playback fast-forwards with sound (cues forwards) at 2 x speed.

Pressing this key while holding down the [STOP] key moves the recorder to the recording end (REC END) of the current file.

11. [REW] key/indicator (green)

Pressing this key while stopped rewinds the recorder at maximum 30 x speed.

Pressing this key during playback rewinds with sound (cues backwards) at 2 x speed.

Pressing this key while holding down the [STOP] key moves the recorder to the beginning (ABS 0) of the current file.

12. [PANEL LOCK] switch

Switches the panel lock function active (LOCKED) or inactive (OFF).

When set it to the "LOCKED" position, all keys except the [REC], [PAUSE] and [EXIT/BATT] keys are inactive.

13. [OPEN] lever

Releases the lock of the protection cover of the tray (see page 33).

When you close the cover, press and lock the protection cover by hand.

Rear panel

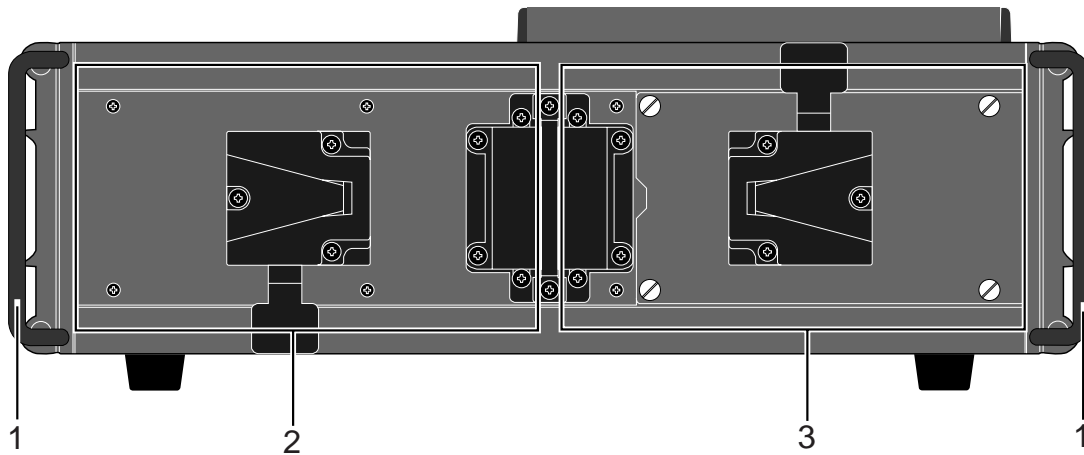

1. Protectors

These protect the bottom panel when the unit is used vertically. When a battery is fitted, extend the protectors. You can adjust the height of the protectors by hand while sliding the [ADJUST] levers on the left and right side panels (see page 25).



When no battery is fitted, the protectors protect the projections on the bottom panel.

<Note>: When the unit is set vertically with the projectors extended, it should be set on a flat and stable surface, because it is easily upset.

2. Battery mount 2

Mounts one or two IDX ENDURA batteries (see page 23 for details). In this manual, we sometimes describe this mount as "BATT2".

3. Battery mount 1

Mounts one or two IDX ENDURA batteries (see page 23 for details). In this manual, we sometimes describe this mount as "BATT1".

By opening the cover of battery mount 1, you can exchange the internal hard disk drive (see page 37 for details about how to change the hard disk drive).

* IDX, IDX (logo), ENDURE, V-Mount, V-Plate, Digi-View and i-Trax are the trademarks of IDX Company Ltd..

LCD display details

Home screen

Each of the following screen examples is the screen which appears when an audio file recorded on a DVD-RAM disk or the internal hard disk is loaded.

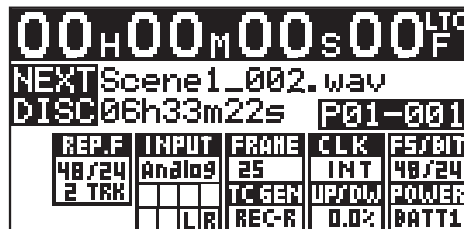

The Home screen displays information for audio file, settings, etc.

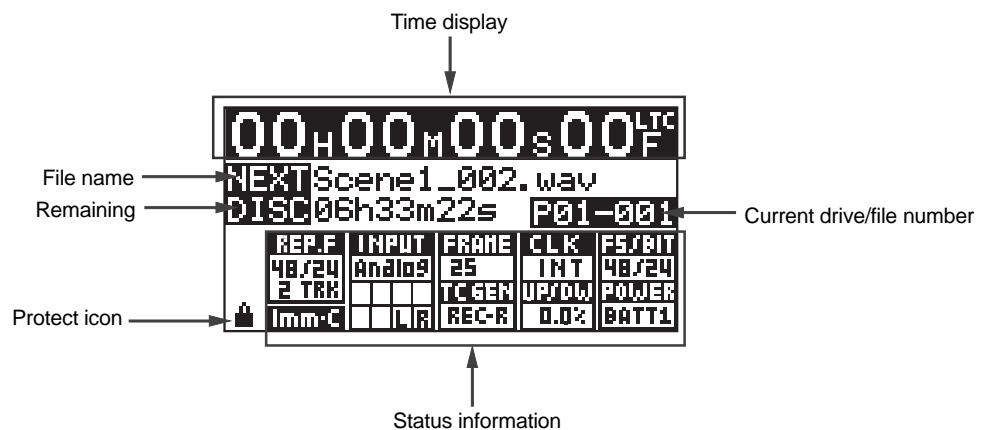

Time display



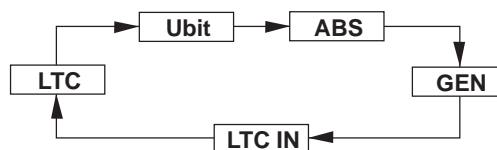





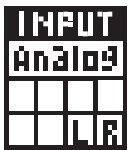
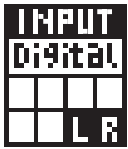

This area shows the time value of the current file position in "ABS" or "LTC". It also can show an external time code value or internal generator time code value. You can switch the time display mode in the following order by pressing the [TIME/TC SET] key.



LTC	Shows LTC recorded on the disk. You can set the start time of LTC recording using the TC SETUP menu of the MENU mode.
Ubit	Shows the user bit information of playback time code.
LTC IN	Shows incoming external LTC and the frame rate. If no LTC is received, "-----" is shown.
ABS	Shows the absolute time, which is set to "00H 00M 00S 00F" at the beginning of the file.
GEN	Shows time code generated by the internal TC generator. The value depends on the setting of the "Gen mode" item in the TC SETUP menu of the MENU mode.



Status information

The status information area shows the current settings including the Fs/bit information of the playback file. Using the quick setup mode, you can make settings directly via the status information area.

	<p>The FS/bit and the number of recorded tracks of the current playback audio file are shown. When playing back an audio file, the status of the playback audio file takes priority over the menu setting. The example on the left indicates that, in the current audio file, two tracks are recorded at 44.1kHz/16-bit.</p>
 	<p>Shows the current recording source (Analog or Digital). When no digital signal is fed to the [DIGITAL IN] connector, "Analog" is shown. When the unit is locking to the digital input, "Digital" is shown (while "L" and "R" are reversed). When "Analog" is shown, you can record analog audio signals which are fed to the [ANALOG IN] connectors on channels 1 through 4 and routed through the mixer section. When "Digital" is shown, you can directly (without routed through the mixer section) record a digital audio signal which are fed to the [DIGITAL IN] connector (without routed through the mixer section).</p>
	<p>Shows the time code frame rate currently set (the default is "25"). You can set the frame rate via the quick setup mode or via the "Frame rate" menu item in the "TC SETUP" menu of the MENU mode (see pages 75/179).</p>
	<p>Shows the current reference clock (the default is "INT"). You can set the clock reference via the quick setup mode or the "Sync Clock" menu item in the "TC SETUP" menu of the MENU mode (see pages 75/175). If the unit does not lock to the external clock reference, the selected option flashes quickly.</p>
	<p>Shows the current FS/bit setting (the default is "48/24"). You can set the FS/bit rate via the quick setup mode or the "Record FS/BIT" menu item in the "SYS SETUP" menu of the MENU mode (see pages 76/142).</p>
	<p>Shows the active power source. You can specify the power source to be used preferentially when more than one source is available via the quick setup mode or the "Active battery" menu item in the "BATTERY SETUP" menu of the MENU mode (see pages 77/169). Note that when only one power source is available, the available source ("DC-IN", "BATT1" or "BATT2") is shown regardless of "Active battery" setting.</p>
	<p>Shows the current pull up/down setting which is effective when the PD204 is referenced to the internal clock (the default is "0.0%"). You can make the pull up/down setting via the quick setup mode or the "Pull up/down" menu item in the "SYS SETUP" menu of the MENU mode (see pages 76/143).</p>
	<p>Shows the current time code recording mode (the default is "REC RUN"). You can set the time code recording mode via the quick setup mode or the "Gen mode" menu item in the "TC SETUP" menu of the MENU mode (see pages 76/177).</p>
  	<p>When executing the auto copy function, it shows the auto copy recording mode currently set (the default is "Off" and none is shown). When the recording mode is set to "Immediately", "Imm-C" is shown, while "BGR-C" is shown when the recording mode is set to "Background". You can set the auto copy recording mode via the quick setup mode or the "Auto copy" menu item in the "SYS SETUP" menu of the MENU mode (see page 104). When executing dual drive recording, "DDR-m" is shown (see page 113).</p>

File name/Next file name

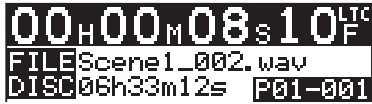
During playback or recording, this area shows the name of the current audio file. In record pause (or stop) mode, it shows the name of the next audio file to be created.

	During recording, this area shows the name of the current audio file, as well as the remaining time.
	While in record pause (or stop) mode, this area shows the name of the next audio file to be created, as well as the remaining time.
	During playback, this area shows the name of the current audio file.

A file name is automatically given and shown according to the setting of the "Default file name" item in the "SYS SETUP" menu of the MENU mode, as follows. (By default, the "Default file name" item is set to "Take". See page 138 for details about the "Default file name" item.)



When "Take" is selected	The file name is given as "<Scene name> + <Take number>". You can specify the Scene name and the starting take number via the MENU mode. The Take number is incremented automatically each time a file is created.
When "Date" is selected	The file name is given as the internal realtime clock data when you start recording.
When "Reel" is selected	The file name is given as "<Disk (or partition) volume label> + <File number>".

Disk remaining

This area shows the remaining recordable space of a disk or partition in time. The remaining time is shown during recording or while stopped. As the recording goes on, the remaining time decreases (see "File name/Next file name" above).

Current drive/file number

This area shows the current drive name and the audio file number. The following shows the examples when an audio file recorded on a DVD-RAM disk or hard disk partition is loaded.

 <p>The DVD drive is selected as the current drive and the audio file "002" is currently loaded.</p>	 <p>Partition 1 is selected as the current drive and the audio file "001" is currently loaded.</p>
---	---

Protect icon

When a hard disk partition is protected, "🔒" is shown.

You can protect or unprotect a hard disk partition via the "DISK UTILITY" menu of the MENU mode (see page 205).

Screen examples

MENU list screen

You can bring up the MENU list screen by pressing the [SHIFT] key followed by the [ENTER/YES] key.

This screen is the first level screen of the MENU mode and you can select a desired menu from the menus for various settings or preferences of the PD204. See page 134 for details.

```
MENU▶
▼SYS SETUP ▶
  BATTERY SETUP ▶
  TC SETUP ▶
  DISK UTILITY ▶
  EDIT EDL FILE ▶
  USB to PC ▶
```

SYS SETUP menu screen

You can bring up this menu screen by selecting "SYS SETUP" from the MENU list screen and pressing the [ENTER/YES] key. The "SYS SETUP" menu includes system setup and execution menu items. See page 136 for details.

```
SYS▶
▼Set Project name▶
  Default file name▶
  Default Trk Name▶
  Next event No:00001
  Record FS&Bit:48k/24
  Pull up/down: 0.0%
```

BATTERY SETUP menu screen

You can bring up this menu screen by selecting "BATTERY SETUP" from the MENU list screen and pressing the [ENTER/YES] key.

The "BATTERY SETUP" menu includes the setup menu items regarding the battery which powers the PD204. See page 165 for details.

```
BATTERY▶
▼BATT. warnings :13.2U
  DC-IN warnings :13.0U
  Power Priority:DC-IN
  Active battery:BATT1
  BATT. Remain:**h**m
  BATT. status ▶
```

TC SETUP menu screen

You can bring up this menu screen by pressing the [SHIFT] key followed by the [TIME] key, or by selecting "TC SETUP" from the MENU list screen and pressing the [ENTER/YES] key.

The "TC SETUP" menu includes the setup menu items for time code recording/playback. See page 174 for details.

```
TC SETUP▶
▼Sync clock:INT
  Frame rate:25
  Gen mode:Rec Run
  Set Gen.TC▶
  Set Gen.Ubit▶
  JAM mode:BOTH
```

DISK UTILITY menu screen

You can bring up this menu screen by selecting "DISK UTILITY" from the MENU list screen and pressing the [ENTER/YES] key.

The "DISK UTILITY" menu includes the setup or execution menu items regarding a DVD-RAM disk (or a partition). See page 190 for details.

```
DISK UTILITY▶
▼Edit file name▶
  File info.▶
  Delete file▶
  Restore Del. file▶
  Format▶
  Reel No:[**** ]
```

USB to PC menu screen

You can bring up this menu screen by selecting "USB to PC" from the MENU list screen and pressing the [ENTER/YES] key.

The "USB to PC" menu is used when connecting the PD204 to a personal computer for audio file transfer. See page 116 for details.

```
MENU▶USB to PC
  Connect USB?
  Sel. partition PT01
  [S002 ]
  Yes :ENTER key
  No :EXIT key
```

EDIT EDL FILE menu screen

You can bring up this menu screen by selecting "EDIT EDL FILE" from the MENU list screen and pressing the [ENTER/YES] key.

From the EDIT EDL FILE menu, you can create or edit an EDL (Edit Decision List) file (ALE file) for exporting recorded audio files to the AVID system. See page 121 for details.

**Audio file select screen**

You can bring up this screen by pressing the [FILE SEL] key, or by selecting "FILE SEL" from the MENU list screen and press the [ENTER/YES] key. This screen shows the list of audio files recorded on the current disk (or partition).

By highlighting the desired file using the [MENU] dial and pressing the [ENTER/YES] key, the file is loaded. See page 96 for details.

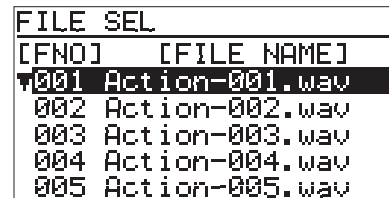
**Drive select screen**

You can bring up this screen by pressing the [SHIFT] key followed by the [FILE SEL] key, or by selecting "DRV/PAT SEL" from the MENU list screen and press the [ENTER/YES] key. From this screen, you can select the drive (DVD or partition) by highlighting the desired file using the [MENU] dial and pressing the [ENTER/YES] key. See page 84 for details.

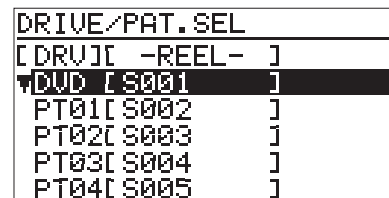
**CUE LIST screen**

You can bring up this screen by pressing the [CUE] key, or by selecting "CUE LIST" from the MENU list screen and press the [ENTER/YES] key. From this screen, you can select the cue point to be checked and edited by highlighting the desired file using the [MENU] dial and pressing the [ENTER/YES] key. See page 93 for details.

**Contrast adjustment screen**

You can bring up this screen by pressing the [SHIFT] key followed by the [LIGHT/CONTRAST] key.

On this screen, you can adjust the contrast using the [MENU] dial, and press the [ENTER/YES] key to confirm the setting as well as dismiss the screen.

Rotating the [MENU] dial clockwise weakens the contrast, while rotating the dial counterclockwise strengthens the contrast. See page 30 for details.



Chapter 4: Basic connections

This chapter describes the basic connection between the PD204 and external devices.

Chapter 4 - Table of contents

Input connection	62
Analog audio input connection	62
Digital audio input connection	63
Time code input connection	63
Sync signal input connection	63
External audio signal connection for monitoring	63
Output connection	64
Analog audio output connection	65
Digital audio output connection	65
Time code output connection	65
Word clock output connection	65
Other connection	66
USB keyboard connection	66
PC connection	68
External controller connection	68
Power supply connection	69
Connection examples	70
Connection example for recording (1)	70
Connection example for recording (2)	71

Input connection

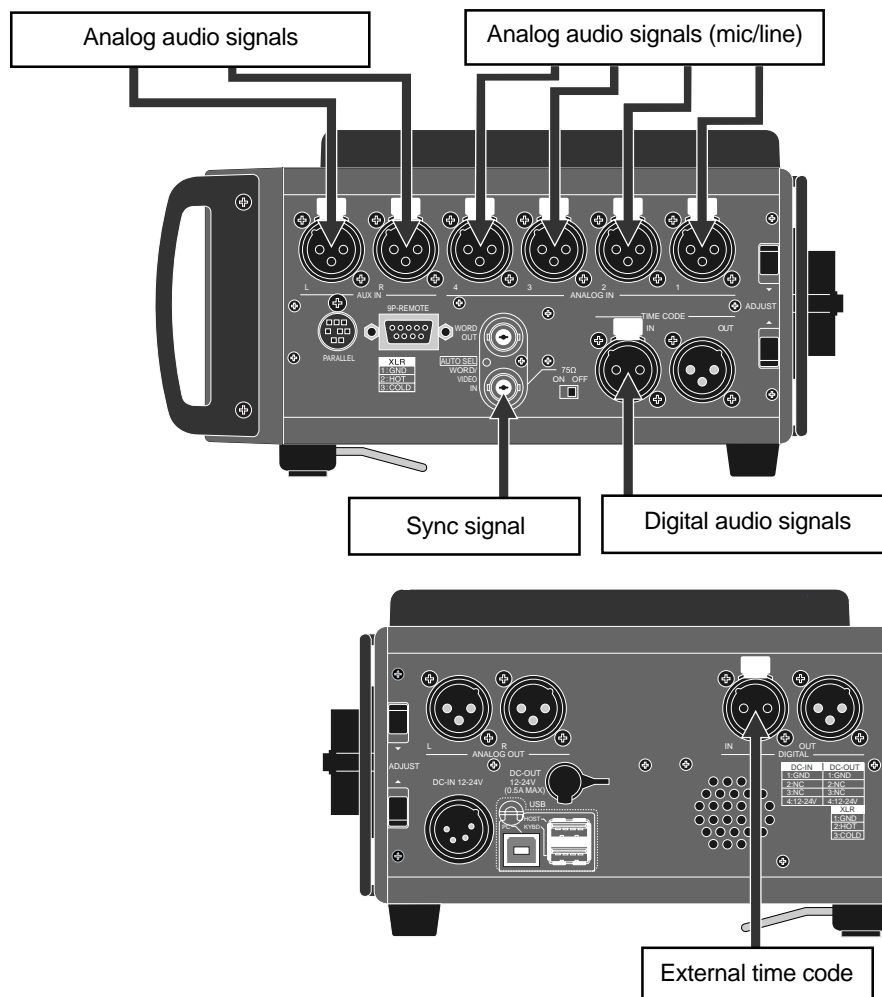

Analog audio input connection

The PD204 provides four analog mic/line input channels (channels 1 through 4). The balanced XLR-3-31 type connector on each channel accepts a wide range of audio signal level from mic to line.

Each channel provides the input selector (LINE or MIC), power supply for microphone, limiter circuit and HPF (high pass filter). The power supply for microphone supports both phantom power (P48) and A-B power (T12) which allows the PD204 to accept various condenser microphones.

The limiter threshold and ratio can be adjusted using the "Limiter parameter" item in the "SYS SETUP" menu of the MENU mode (see page 156).

As for the HPF, you can adjust the cutoff frequency and select the slope curve.

To record an analog audio signal, follow the procedure below (for details, see "Chapter 5: Recording/Playback").

- 1) Set the [INPUT SEL] switch on the top panel to the appropriate position (LINE or MIC) according to the input source.
- 2) Select the Microphone power switch appropriately when you use a microphone.
- 3) Connect an analog source to the [ANALOG IN] connector.

Digital audio input connection

The PD204 accepts digital signals conformed to IEC 60958 Part3 (AES/EBU) or IEC 60958 Part2 (S/P DIF) format (the format of the digital source is automatically detected). The digital connection is made via the XLR-3-31 type connector.

When the PD204 receives a digital source from the selected channel, the PLL (Phased-locked loop) circuit activates and locks to the input sync signal.

<Note>: The sampling frequency of the digital input signal must match the Fs/bit setting of the PD204. You can set the Fs/bit via the "Record FS&Bit" item in the "SYS SETUP" menu of the MENU mode (see pages 76 and 142).

Time code input connection

The [TIME CODE IN] connector (balanced, XLR-3-31) accepts SMPTE/EBU time code. To record external time code, set the TC generator mode to "Ext Run" (Ext). By default, the TC generator mode is set to "Rec Run", however, you can select the desired mode via the quick setup mode or the "Gen mode" item in the "TC SETUP" menu of the MENU mode (see pages 76 and 177).

When the PD204 receives "valid" external time code from the [TIME CODE IN] connector and the time display mode on the display is set to "LTC IN", you can view the incoming time code value as well as the frame rate (you can switch the time display mode using the [TIME/TC SET] key).

When incoming time code satisfies the following conditions, it is "valid".

- 1) **Time code runs in normal direction and value is continuous.**
- 2) **Sync word matches the frame rate.**
- 3) **Time code is not dropped out.**

- For details about how to jam to external time code, see "Chapter 5: Recording/playback" described later.

Sync signal connection

The PD204 provides the [WORD/VIDEO IN] connector (BNC type) which is used to lock the PD204 to an external word or video reference.

The connector accepts a word or video clock from an external device (the clock type is automatically detected), which makes the PD204 locked to the external device.

External audio signal connection for monitoring

The signal fed to the [AUX IN (L, R)] connectors are routed to the monitor circuit. Using this facility, you can monitor the audio signal from an external device such as a camera.

The balanced XLR-3-31 type connectors are used for the [AUX IN (L, R)] connectors.

<Note>: You cannot record the signals fed to the [AUX IN (L, R)] connectors.

Output connection

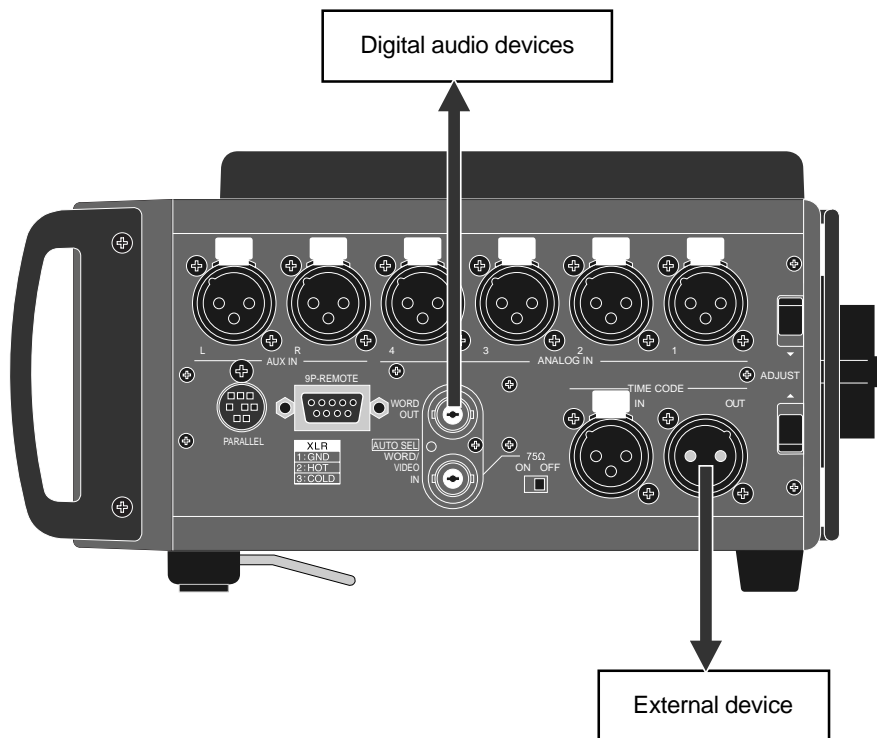
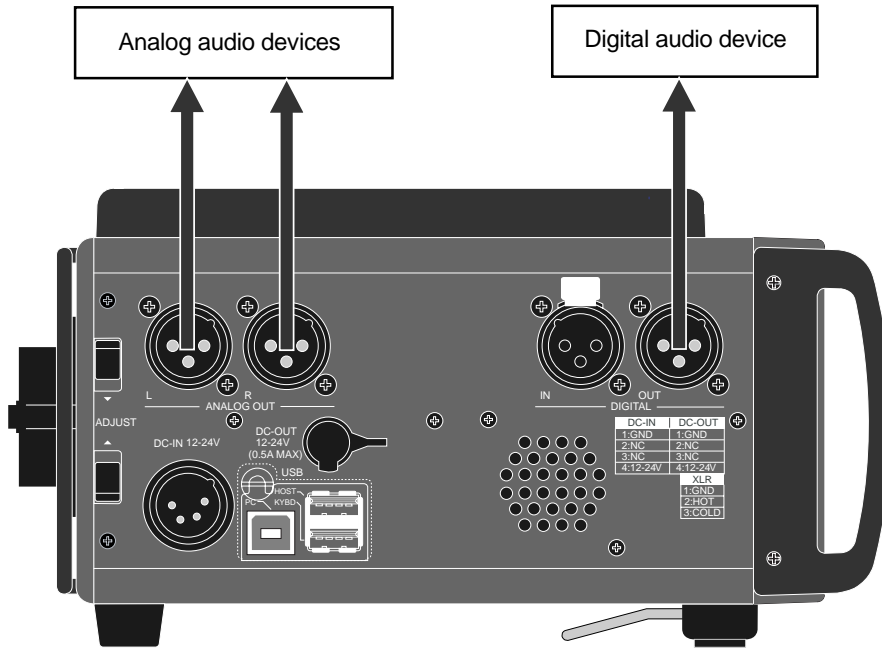

Analog audio output connection

Analog audio signals can be output from the [ANALOG OUT] connectors (L and R), which are balanced, XLR-3-32 type. The output reference level is +4 dBu which corresponds to -20 dB of the ST BUS bargraph meters.

The reference level is set to "+4dBu" by default, however, you can change it to "-10dBu" or "-60dBu" using the "Stereo out level" item in the "SYS SETUP" menu of the MENU mode (see page 157).

<Note>: To connect the [ANALOG OUT] connector to an unbalanced input, only use the GND and hot pins. With this connection, the output level is 6 dB lower than the balanced connection but there is no audio quality deterioration. Connecting the cold pin to the GND pin increases the crosstalk and noise, as well as consumes more battery power.

Digital audio output connection

The digital audio signals can be output from the [DIGITAL OUT] connector (XLR-3-32 type) in the IEC 60958 Part3 (AES/EBU) or IEC 60958 Part2 (S/P DIF) format.

You can select the digital output signal format (AES/EBU or S/P DIF) using the "Digital out" item in the "SYSTEM SETUP" menu of the MENU mode.

See page 144 for details about the "Digital out" item.

Time code output connection

You can output SMPTE/EBU time code from the [TIME CODE OUT] connector (balanced, XLR-3-32 type).

According to the "Sel. TC Out" item in the "TC SETUP" menu of the MENU mode, time code recorded on a disk (REPRO TC) or generated by the internal time code generator (INT GEN TC) is output (see page 183).

Word clock output connection

Using the [WORD OUT] connector (BNC type), you can feed a word clock to a digital device which needs a word clock for synchronization.

Other connections

USB keyboard connection

The PD204 provides the [USB (KYBD)] connector for connecting a USB keyboard. By connecting a USB keyboard to this connector, you can enter file and label names as well as carry out some of menu operations from the keyboard.

- <Notes>**
- To control the unit from a USB keyboard, make setting of the "Keyboard Sel" item in the "SYS SETUP" menu of the MENU mode appropriately ("US" or "JAPAN") according to the keyboard you use (see page 150).
 - With some keyboard, indicators may not light until you press any key after connection.
 - We cannot guarantee to work correctly if you use a keyboard with the built-in USB hub, USB mouse or PS2 mouse.

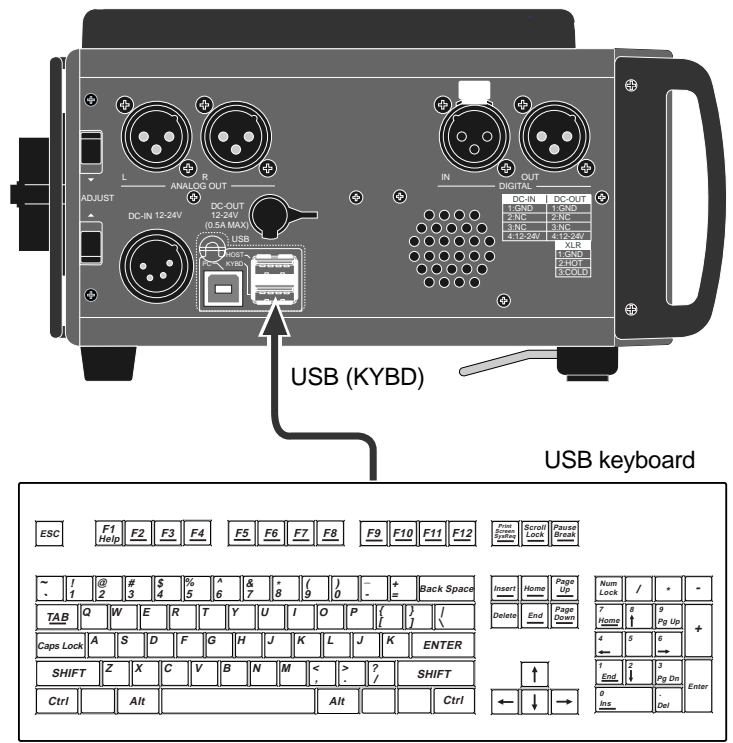

Function keys

F1 key	Brings up the screen for the "Edit file name" item in the DISK UTILITY menu.
F2 key	Acts the same as the [CIRCLE TAKE] key on the panel.
F3 key	Brings up the screen for the "Default file name" item in the SYS SETUP menu.
F4 key	Brings up the screen for the "Default track name" item in the SYS SETUP menu.
F5 key	Brings up the screen for the "Set Gen TC" item in the TC SETUP menu.

Shortcuts

ALT + F keys	Acts the same as the [FILE SEL] key on the panel.
ALT + D keys	Acts the same as the [SHIFT] key + [FILE SEL] key on the panel.
ALT + C keys	Acts the same as the [CUE] key on the panel.
ALT + S keys	Enters the SYS SETUP menu.
ALT + U keys	Enters the DISK UTILITY menu.
ALT + T keys	Enters the TC SETUP menu.
ALT + E keys	Enters the EDIT EDL SEL menu.

Control key

CTRL+ L key	Acts the same as the [LOCATE] key on the panel.
--------------------	---

Other keys

Left/Right/Up/Down key	These keys can be used to enter characters or move the cursor point when editing a name for a label or file name or in the MENU mode.
Left/Right key	Act as the [◀◀] and [▶▶] keys respectively.
BS key	Deletes the character to the left of the cursor point when editing a name.
DEL key	Deletes the characters of the cursor point as well as at the cursor point when editing a name.
ENTER key	Acts the same as the [ENTER/YES] key on the panel.
ESC key	Acts the same as the [EXIT] key on the panel.
HOME key	Returns the display to the Home screen.

<Note>: The functions assigned to keys of USB keyboard may change for product improvement.

PC connection

The PD204 provides the [USB (PC)] connector dedicated for PC connection. By connecting a personal computer to this connector, you can control the PD204 drive from the personal computer as well as transfer an audio file between the PD204 and personal computer (see page 116 for details).

<Note>: To use the PD204 with a personal computer, make setting of the "USB to PC" menu of the MENU mode to "CONNECT". See page 117 for details.

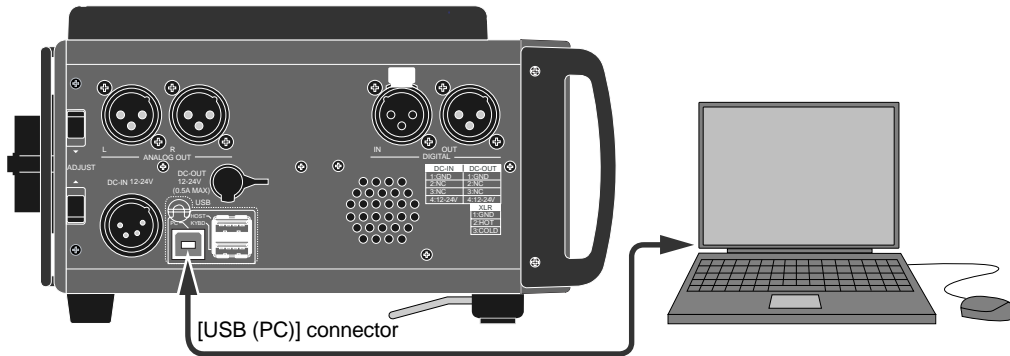

External controller connection

The PD204 provides the [PARALLEL] connector (MINI DIN 8-pin) on the right side panel. By connecting an appropriate controller to this connector, you can control the following PD204 operations externally.

1	PLAY	2	REWIND	3	PAUSE
4	STOP	5	FAST FORWARD	6	⏪
7	REC	8	CUE point entry	9	⏩

<How it works>

Each operation is active by grounding the corresponding terminal (see page 43 for details).

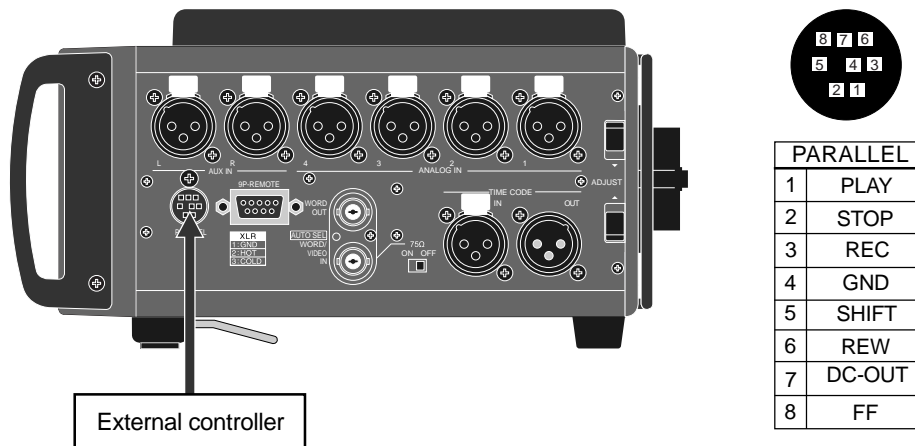

Power connection

The [DC IN] connector (XLR-4-32 type) on the left side panel is used for operating the unit on the optional AC adaptor or an external battery. The PD204 also provides the [DC OUT] connector for supplying DC-12V to an external device.

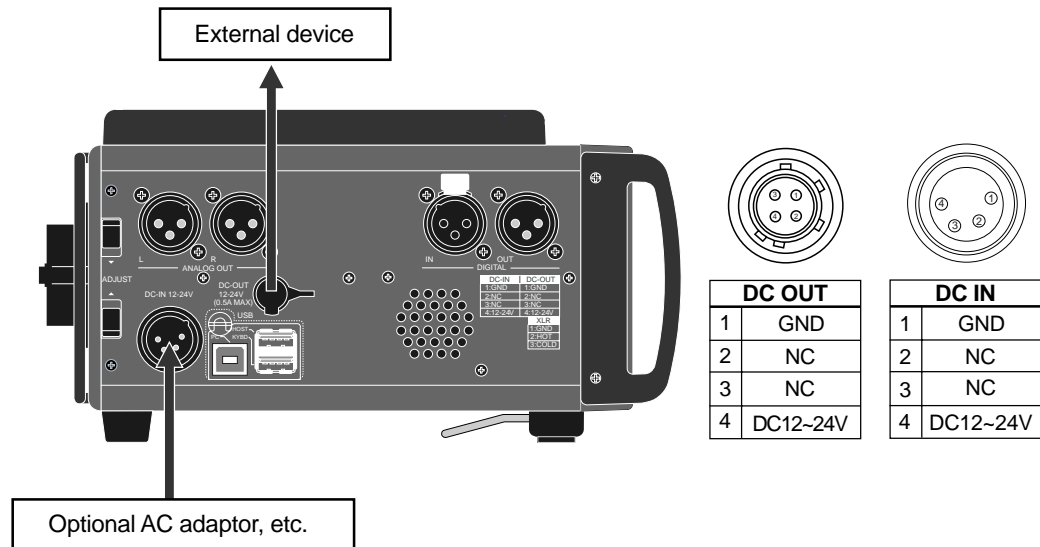

<Notes>

- The [DC OUT] connector can deliver up to 0.5 ampere electric current at DC 12V to 24V. Only connect a device which meets this requirement.
- We strongly recommend using the [DC OUT] connector while you are operating the PD204 on the AC adaptor (or an external battery). If you use the [DC OUT] connectors to supply the power to an external device while the PD204 runs on the battery, the battery power is exhausted quickly.

Connection examples

Connection example for recording (1)

The following shows the example of using the PD204 with microphones, which makes the best use of the PD204 and can be applied to news gathering, audio recording for film, etc.

In the example below, audio signals from microphones and time code generated by the external time code generator are simultaneously recorded to the PD204, while the same time code is also recorded to the VTR along with a video camera signal. Up to four microphones can be connected to the PD204 input channels, allowing recording various sources simultaneously.

The external time code generator output is connected to time code inputs of both the VTR and PD204. Using the PD204 jam function, the PD204 time code generator can run with extreme accuracy after it locks to external time code.

Therefore, you can make PD204 recording in sync with the VTR even if you disconnect the time code input after the PD204 generator locks to external time code. When external time code is disconnected, the internal generator runs with its own crystal (when the generator mode is set to "FREE RUN"). See pages 92 and 182 for details about the jam function.

You can also connect the audio output of a camera to the [AUX IN (L, R)] connector for monitoring via headphones.

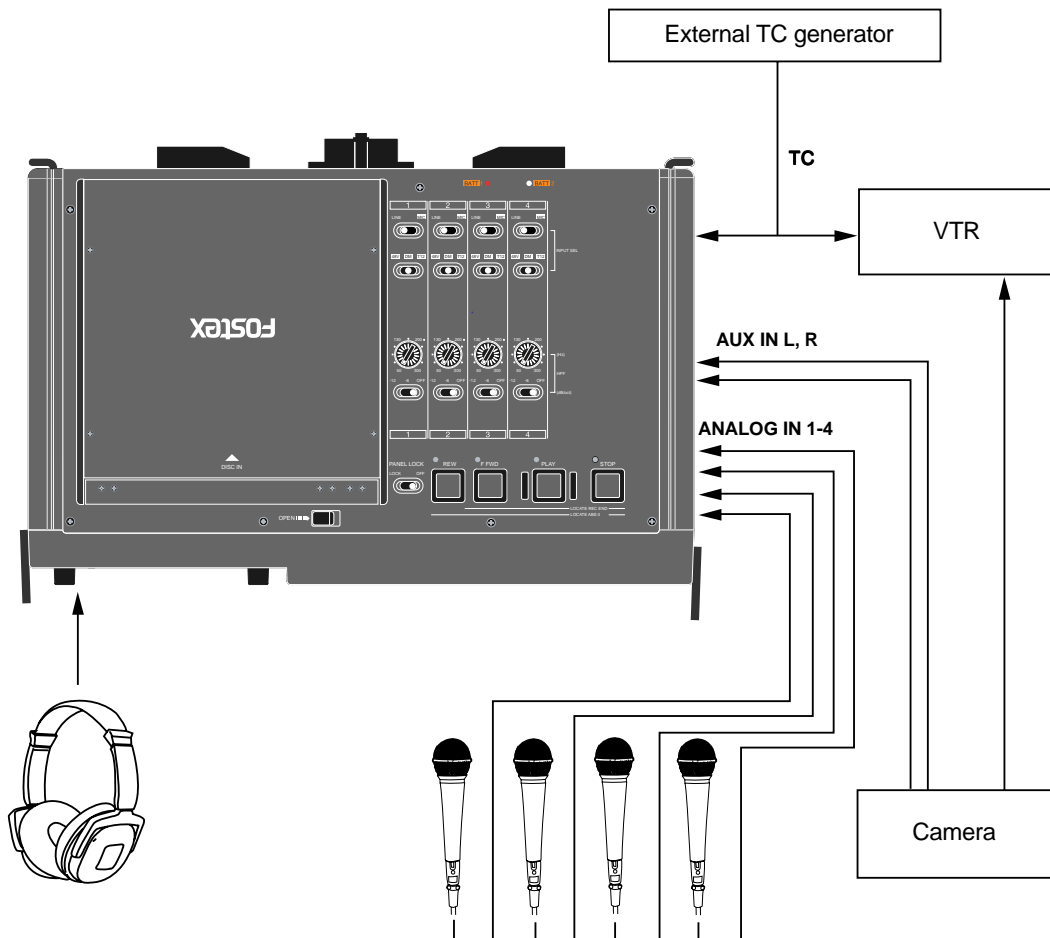

Connection example for recording (2)

In the following example, two main microphones (mono) and two ambience microphones (stereo) are connected to the PD204 four-channel mixer, without using an external mixer.

Unlike the previous example, the time code generated by the PD204 internal time code generator is the master which is fed to the VTR. The [ANALOG OUT] connector always feeds the mixed source signals, which can be recorded to the VTR audio tracks for backup purpose.

You can also monitor audio signals from an external device using the [AUX IN (L, R)] connectors.

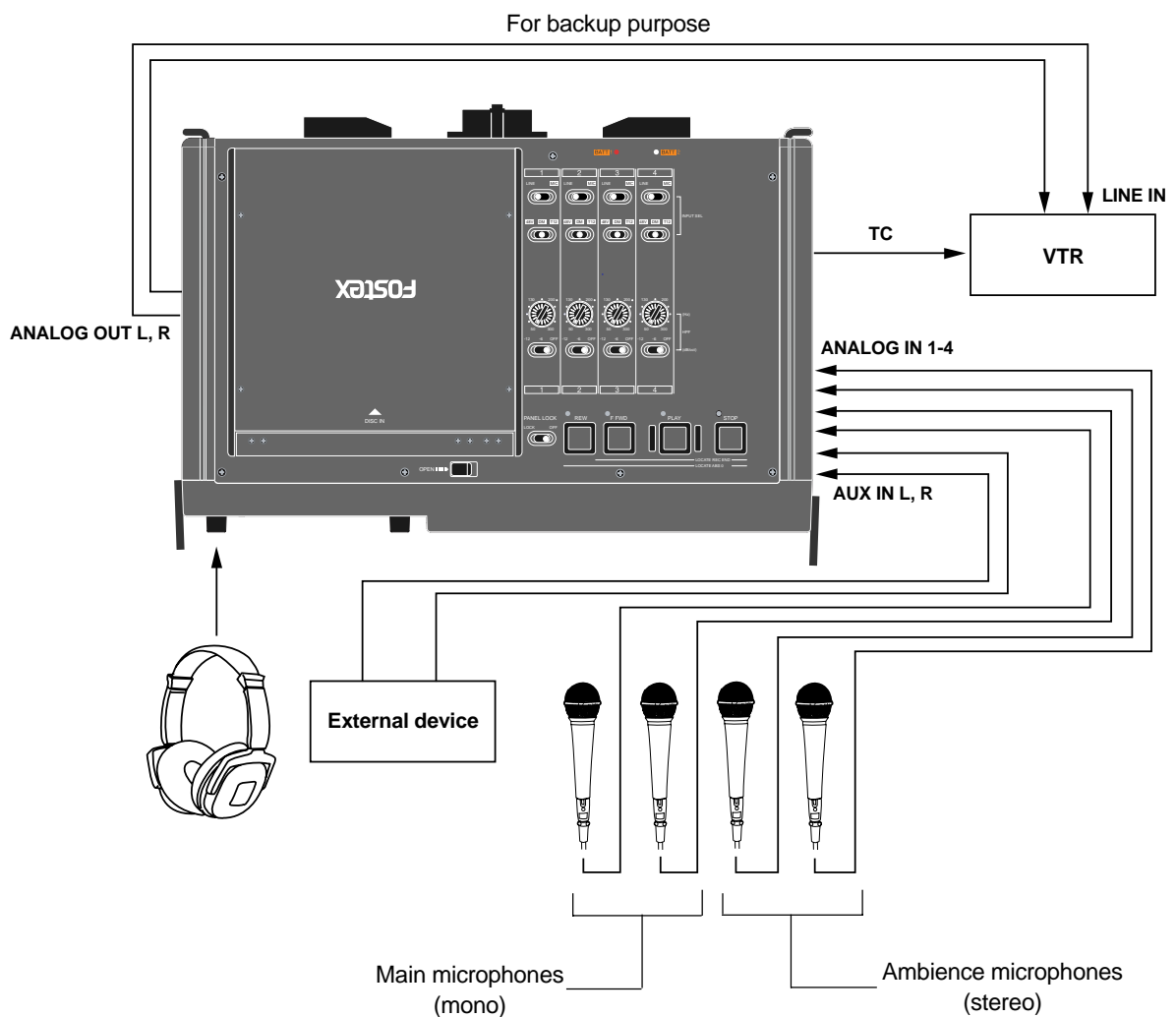

Chapter 5: Recording/Playback

This chapter describes basic recording and playback of analog and digital audio signals, as well as cue point setting and skip/locate functions.

Chapter 5 - Table of contents

Preparation before recording	74
Setup for recording in quick setup mode	74
Setting in the MENU mode	77
Mixer settings	78
Selecting the drive for recording	84
Recording analog audio signals	85
Starting recording	85
Canceling recording (False Start)	86
Recording in Pre rec mode	87
Recording a slate tone/slate mic signal	88
Recording digital audio signals	89
Selecting the sampling frequency/bit length	89
Selecting the system clock	89
Recording time code	90
Selecting the TC frame rate	90
Selecting the TC generate mode (TC recording mode)	90
Automatic record start by external time code	91
Setting the time code output	91
Force jamming to external time code (Jam function)	92
Cue point setting	93
Setting a cue point on the fly during audio recording	93
Viewing the cue point list	93
Editing a cue point	94
Adding a new cue point to the cue point list	95
Basic playback	96
Normal audio playback	96
Cueing playback	97
Time code playback	97
Skip/locate functions	98
Skipping by file	98
Skipping by cue point	98
Locating to the beginning (ABS 0) of a file	99
Locating to the end (REC END) of a file	99
Locating to the previous locate point	99
Locating to the desired time	100
Locating to the desired cue point	101

Preparation before recording

Before starting audio recording, make necessary settings in the quick setup mode (or the MENU mode), as well as mixer settings.

Setup for recording in quick setup mode

In the quick setup mode, you can make basic settings for recording via the Home screen, while you can make all preferences for the unit via the appropriate menu items in the MENU mode. You can make the settings of the following items listed below from the status information area pointed by the arrow on the Home screen example below.

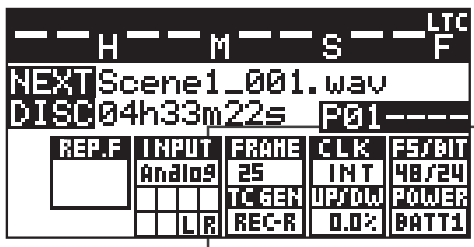

1. LTC frame rate
2. System reference clock
3. Recording Fs/bit
4. TC recording mode
5. Clock pull up/down
6. Prioritized power source

How to make settings in the quick setup mode

You can make settings in the quick setup mode by following the procedure below.

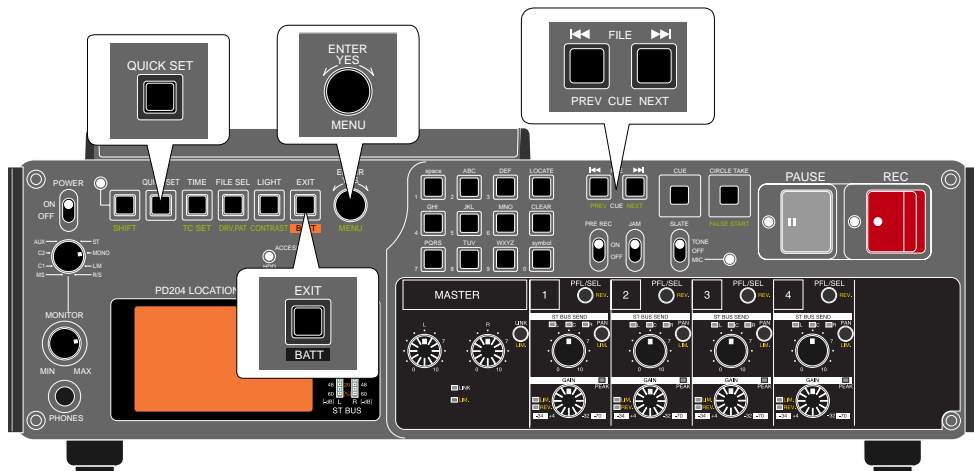

- 1) While the display shows the Home screen and the unit is stopped, press the [QUICK SET] key. By default, "FRAME" in the status information area flashes.



In this condition, rotating the [MENU] dial (or pressing the [◀] or [▶] key) moves the flashing position in the following order.



- 2) **Select the desired item you want to edit and press the [ENTER/YES] key.**
The current option of the selected item starts flashing and you can now select the desired option using the [MENU] dial.

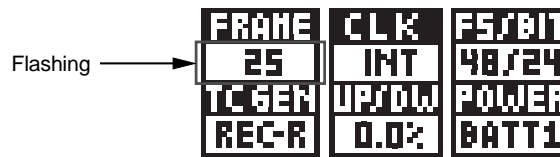

- 3) **Use the [MENU] dial to select the desired option and press the [ENTER/YES] key.**
The selected option is set and the item name flashes again.
Repeat steps 2) and 3) for setting another item if required.
- 4) **After completing settings, press the [EXIT] key to exit the quick setup mode.**
For details about each item in the quick setup mode, see the following.

Frame rate selection for LTC (or external time code) [**FRAME**]

You can select the frame rate of LTC generated by the internal TC generator or external time code.

Available frame rate options (default: 25)
23 (23.97), 24, 25, 29.97DF, 29.97ND, 30DF, 30ND

The unit records LTC together with audio signals. By default, "01h 00m 00s 00f" is stamped at the beginning (one-hour offset to ABS) and the generator records LTC jammed to this start time code. The LTC recording mode ("TC GEN" mode) is set to "Rec Run" by default, so each time you make audio recording, uninterrupted LTC is recorded. When you record an external time code, set the frame rate to match the incoming time code.

You can set the time code frame rate also via the "Frame rate" menu item in the "TC SETUP" menu of the MENU mode (see page 176 for details). You can edit the LTC start time via the "Default LTC Start" menu item in the "TC SETUP" menu of the MENU mode. See page 184 for details.

System clock reference selection [**CLK**]

You can select the system clock reference.

Available clock reference options (default: INT)
INT, DIGI, WORD, VIDEO

To make recording with internal clock reference, select "INT" (default). To make the unit lock to an external digital, word or video clock, select "DIGI", "WORD" or "VIDEO".

You can select the system clock reference also via the "Sync Clock" menu item in the "TC SETUP" menu of the MENU mode (see page 175 for details).

<Note>: When "DIGI" (or "WORD" or "VIDEO") is selected but the unit does not receive a correct digital (or word or video) signal or does not lock to the reference signal, "DIGI" (or "WORD" or "VIDEO") quickly flashes. In such a case, check cable connection, etc.

<Note>: When the system clock is set to "DIGI" or "WORD", the FS of a file to be played back must match the FS setting of the unit. Otherwise, you cannot play back the file. In such a case, make the FS setting of the unit to match the FS of the file.

Sampling frequency and bit length selection [**FS/BIT**]

You can select a sampling frequency and bit length combination.

Available FS/BIT options (default: 48/24)
44.1/16, 44.1/24, 48/16, 48/24, 88.2/24, 96/24, 176.4/24, 192/24

You can select a sampling frequency and bit length combination also via the "Record FS&Bit" menu item in the "SYS SETUP" menu of the MENU mode (see page 142 for details).

<Note>: The sampling frequency of the digital input signal must match the Fs/Bit setting of the PD204.

<Note>: If you change the FS/BIT setting during recording, the new setting is not valid until recording stops.

TC generator mode setting (TC recording mode) [**TC GEN**]

You can select the recording mode of the LTC generated by the internal TC generator or external time code.

Available TC recording mode options (default: Rec-Run)
FREE (Free Run), Rec-R (Rec-Run), 24H-R (24H-Run), EXT (Ext Run)

You can also select the TC recording mode via the "Gen mode" menu item in the "TC SETUP" menu of the MENU mode (see page 177).

<Note>: You can set the default LTC start time via the "Default LTC Start" menu item in the "TC SETUP" menu of the MENU mode (see page 184).

Clock pull up/pull down setting [**UP/DW**]

You can make the pull up/pull down setting of the sampling clock/internal TC frame rate when the clock reference is set to "INT".

Available pull up/pull down options (default: 0.0%)
+0.1%, 0.0%, -0.1%

You can also make the pull up/pull down setting via the "Pull up/down" menu item in the "SYS SETUP" menu of the MENU mode (see page 143 for details).

<Note>: You cannot make pull up or down setting when the time code frame rate is set to 25 fps. If you select "+0.1%" or "-0.1%" when the frame rate is set to 25 fps, "+0.1%" or "-0.1%" is shown in the "UP/DW" field.

Power source priority selection [**POWER**]

You can select the prior power source when the unit can get power from both the battery and [DC-IN] connection.

Available power source options (default: BATT1)
BATT1, BATT2, DC-IN

<Note>: Only the available power source(s) can be selected. When only one power source is available, it is automatically selected.

You can also select the prior power source via the "Active battery" and "Power priority" items in the "BATTERY SETUP" menu of the MENU mode. (see page s 168 and 169)

Settings in the MENU mode

In the MENU mode, you can set many items besides those you can set via the quick setup mode. Set the items in the MENU mode for recording/playback shown below if required.

Default file name setting

The "Default file name" menu item selects the default name format of an audio file which is created automatically when recording starts.

The "Default file name" is initially set to "SCENE NAME + Take number". So the name of the first file recorded is "SCENE_001.wav." (You can set the desired scene name instead of the default "SCENE").

You can select the default name format from "DATE" and "Reel Number + File Number" in addition to the default "SCENE NAME + Take number".

You can select the default file name via the "Default file name" item in the "SYS SETUP" menu of the MENU mode (see page 138).

Maximum file size setting

The maximum recording size per file can be selected. The default size is 2GB.

You can change it to 4GB according to the capacity of your personal computer which receives an audio file created by the PD204.

You can select the maximum file size via the "Max file length" item in the "SYS SETUP" menu of the MENU mode (see page 152).

Partition link setting

This setting is valid only when you make recording to a hard disk partition.

If partition link is enabled, when there is no recording space left in the current partition during recording, the unit automatically creates a new file in the next partition and continues recording to it. By default, partition link is disabled.

You can select partition link setting via the "Auto part. link" item in the "SYS SETUP" menu of the MENU mode (see page 153).

Error tone output setting

During recording, if the unit encounters the following problems, the error tone is output for warning.

1. A write error happens during recording.
2. The input amplifier is clipped during recording.
3. The battery voltage drops below the specified level.
4. The remaining volume of a disk (or partition) becomes less than the specified volume.

You can make error tone output setting via the "Error tone" item in the "SYS SETUP" menu of the MENU mode (see page 160).

Mixer settings

The mixer section provides the function for mixing four analog input sources to the stereo bus. You can record the stereo bus signals to stereo L/R tracks. (When you record a digital input signal, the signal is directly recorded to the stereo L/R tracks without being routed to the mixer section.)

The four input channels of the mixer section provide controls for the analog input signal, including the filter, limiter, etc.

The following diagram shows the signal flow of the mixer section of the PD204.

Read the explanation described in the following pages and make mixer settings appropriately.

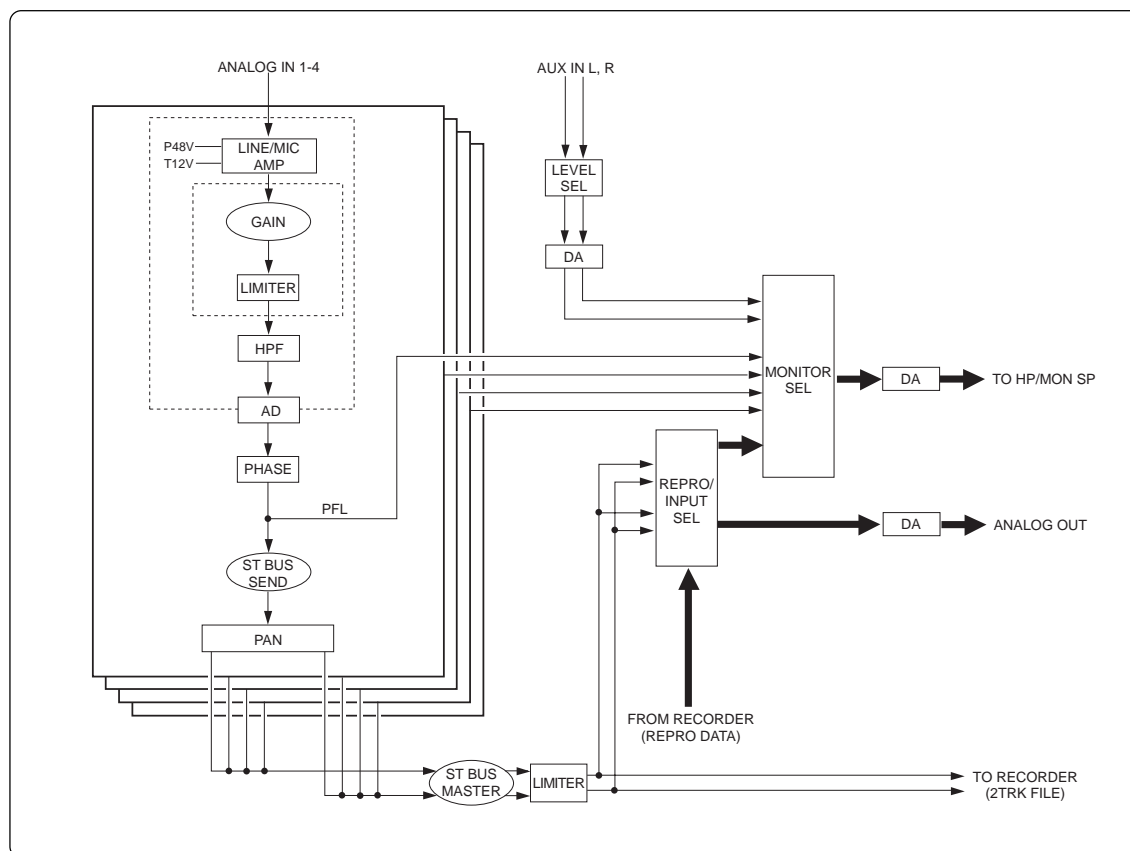

Input signal selection

According to the analog audio signal fed to the [ANALOG IN] connector, set the LINE-MIC switch to "LINE" or "MIC". When you select "MIC", set the phantom power switch to "48V", "DM" or "T12" appropriately according to the microphone connected.

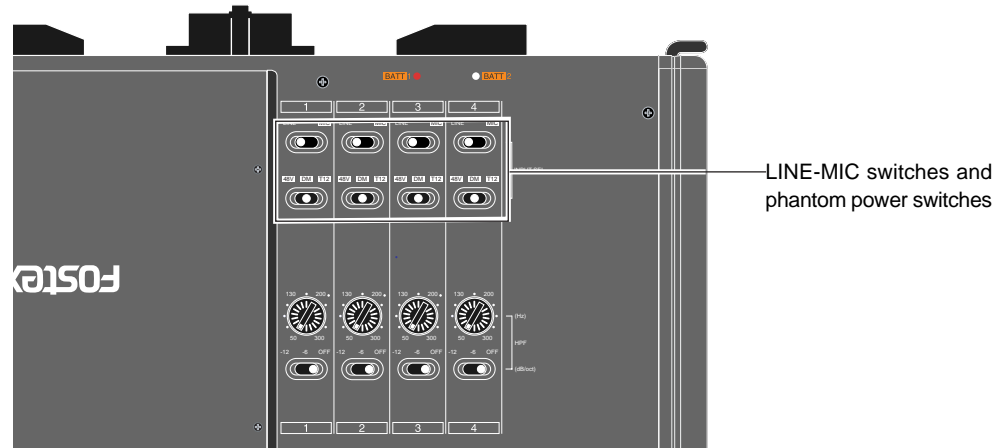

High-pass filter setting

The PD204 is equipped with the high-pass filter circuit. The cutoff frequency can be adjusted within the range between 50 Hz and 300 Hz, while the filter slope can be selected between -6 dB/oct. and -12 dB/oct.

The filter is useful to eliminate the wind noise during location recording or unnecessary low frequency noise when recording voice or sound. You can make filter setting for each channel individually.

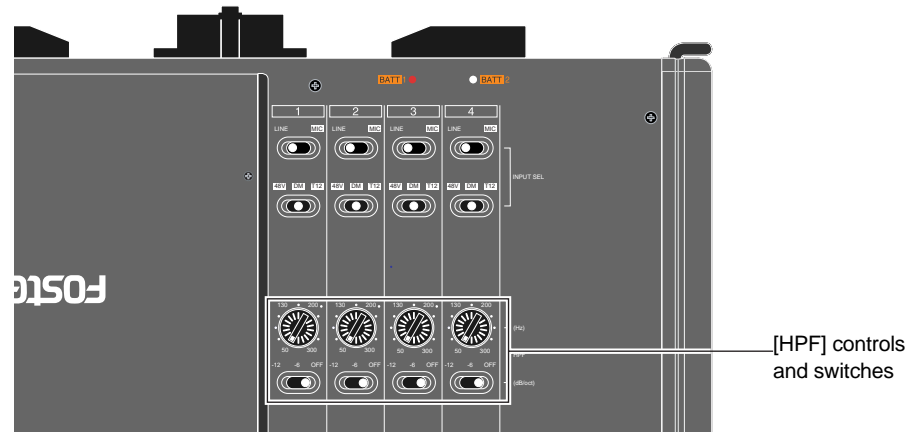

Limiter setting

By using the limiter when recording microphone sound, the signal level is prevented from exceeding a certain level. In result, the signal level fluctuation is suppressed. By default, the threshold of the PD204 limiter is set to -12 dB under the 24-bit full-scale level (all bits are ON) and the compressed ratio is set to 1:5. The limiter attack time is fixed to 5 ms, while the release time is fixed to 200 ms. You can set limiter parameters using the "Limiter parameter" menu item in the "SYS SETUP" menu of the MENU mode (see page 156 for details).

<Note>: When you use the limiter function, see also "Gain adjustment" on the page 81.

You can enable or disable the limiter function on each channel (1 through 4) by pressing the [SHIFT] key followed by the [PAN] key. On the other hand, you can enable or disable the limiter function on stereo bus by pressing the [SHIFT] key followed by the [LINK] key. When the limiter function is active, the [LIM.] indicator of the corresponding input channel (as well as the stereo channels) is lit. When the limiter is actually working, the [LIM.] indicator flashes quickly.

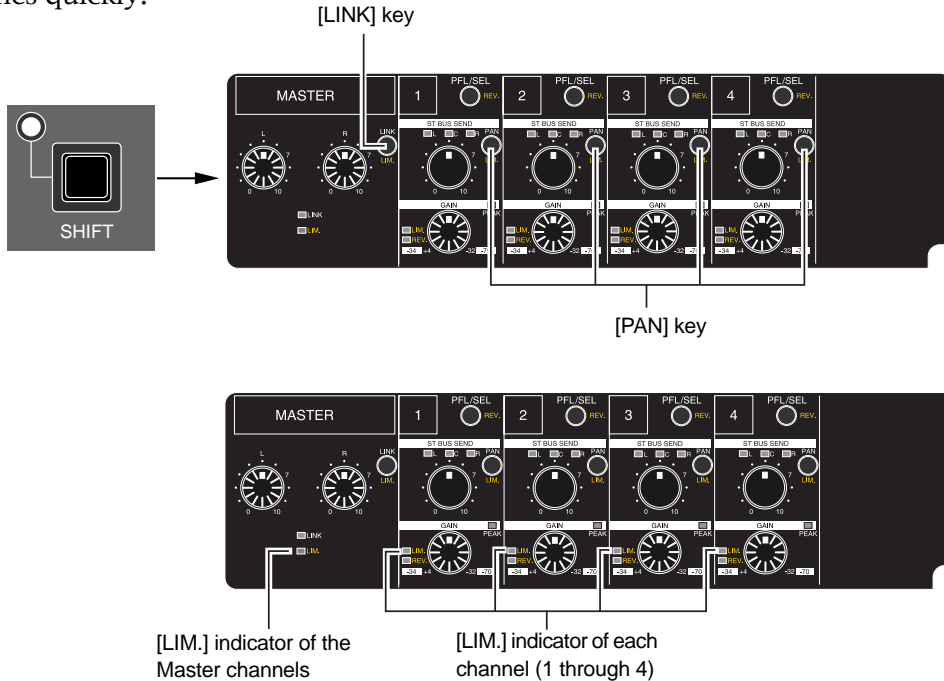

Adjusting the input gain (for channels 1 through 4)

Using the [GAIN] control, you can adjust the input gain for each channel. The nominal input level can be adjusted within the following range.

- When the LINE-MIC switch is set to "LINE": -32dBu to +4dBu
- When the LINE-MIC switch is set to "MIC": -34dBu to -70dBu

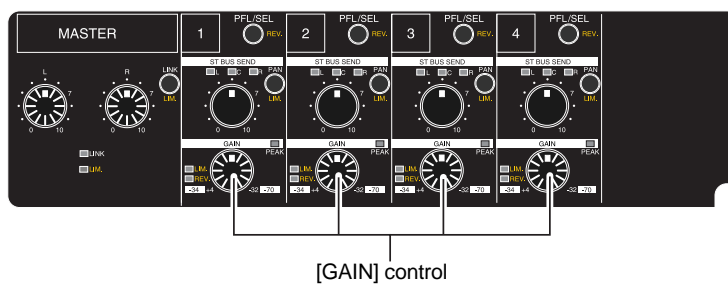

Adjust the input gain of each channel appropriately so that the corresponding [PEAK] indicator does not flash or light in red.

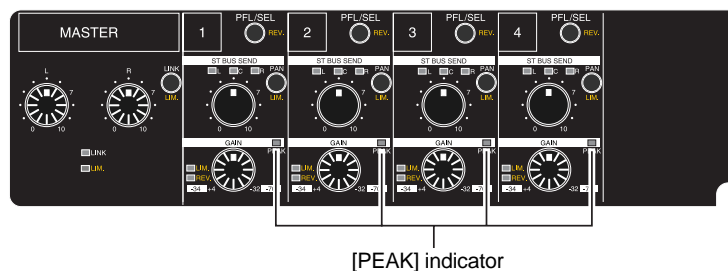

<Notes>

- Adjust the recording level appropriately so that the level meter does not exceed "0 dB" but goes up near to the "0 dB" at the loudest part of the signal.
The reference level is set to "-20 dB" by default. This means a +4 dBu signal indicates 20 dB down from the 24-bit full-scale level (0 dB) on the level meter.
- You can set to generate the error tone when the input amplifier clips using the "Error tone" menu item in the "SYS SETUP" menu of the MENU mode (see page 160).

<About gain adjustment>

The PD204 controls the gain by the advanced digital control volume with the latest technology, which offers the following advantages.

- (1) **Improvement of audio quality by simplifying the analog circuit.**
- (2) **Controls the volume of an input signal and can be used as an analog limiter with no sound deterioration unlike a conventional VCA limiter.**

This volume control provides the zero-crossing control function which restrains an unwanted stepping noise.

<Zero-crossing control function>

The zero-crossing is the instantaneous point at which there is no voltage present (indicated by arrows in the figure on the right). The zero-crossing control function alters the audio level at the zero-crossing point to prevent generating a stepping noise of a digitally controlled volume.

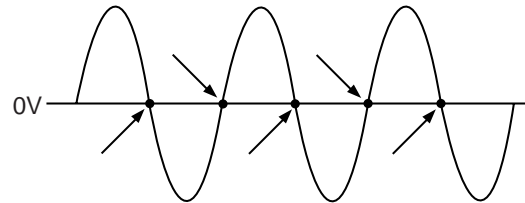

<Note on gain adjustment>: When no signal or very low-level signal is fed, the unit may not detect zero-crossing points, resulting generating a small amount of the stepping noise.

<Limiter function>

On channels 1 through 4, the limiter function is achieved by automatically controlling the digital control volume on each channel. (Note that the ST BUS channel limiter works differently.)

<Notes on using the limiter function>: Due to the nature of the digitally-controlled volume, a small amount of the stepping noise may be generated in the following conditions.

- (1) **When a single low frequency signal is fed.**
- (2) **When channels are linked and the limiter on the channel with no input signal works.**

If you hear the stepping noise in the condition as above, we recommend that you do not use the limiter function of the PD204 or you use an external limiter.

Phase setting (for channels 1 through 4)

You can reverse the phase of the input signal by pressing the [SHIFT] key followed by the [PFL/SEL] key of the desired channel. The [REV.] indicator under the bargraph meter of a phase-reversed channel is lit. To disable the phase reverse, press the [SHIFT] key followed by the [PFL/SEL] key again.

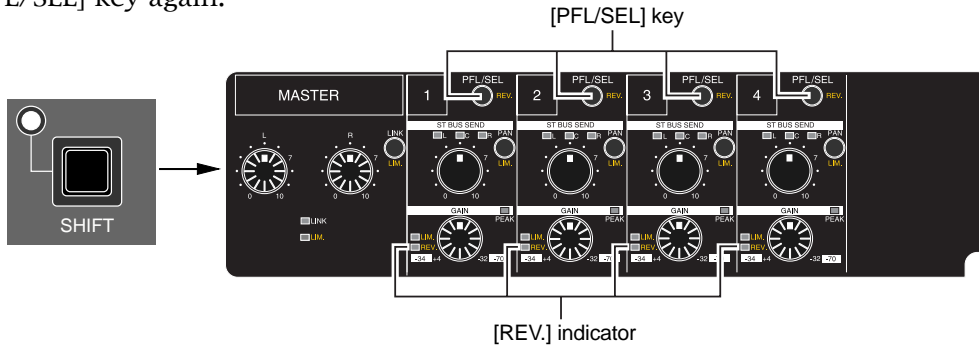

Controlling signals sent to the stereo bus

Using the [PAN] key on each of channels 1 through 4, you can select "L", "C" or "R" for the panning position of the channel signal sent to the stereo bus. Each time you press the [PAN] key, the option ("C", "R", "OFF" or "L") changes, and the corresponding indicator lights. When "Off" is selected, no indicator is lit and the channel signal is not sent to the stereo bus.

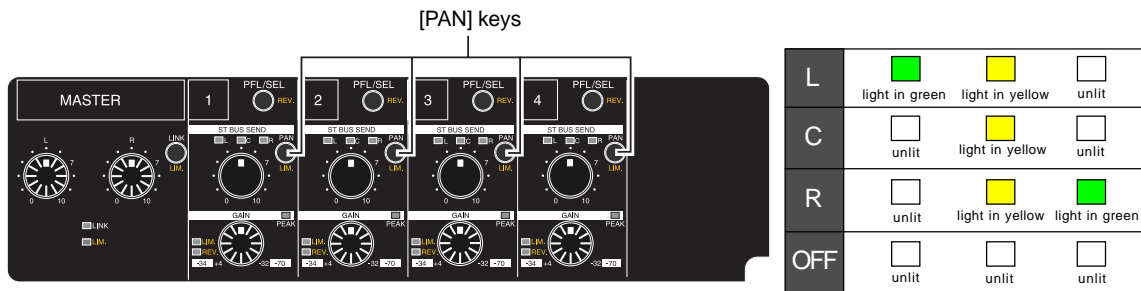

Using the [ST BUS SEND] control on each of channels 1 through 4, you can adjust the signal level sent to the stereo bus. Using the [MASTER (L, R)] control, you can adjust the stereo bus master level.

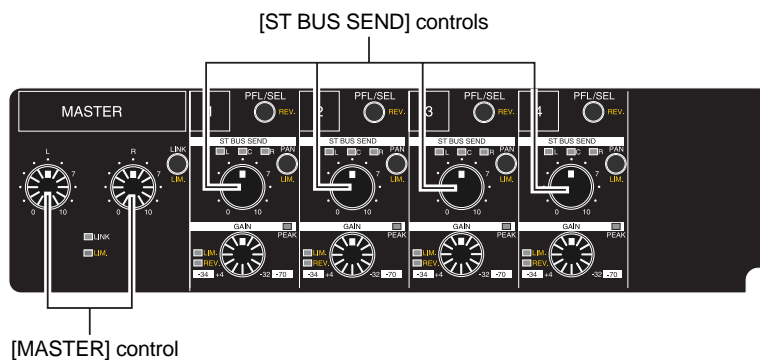

<Linking the MASTER (L, R) controls>

By pressing the [MASTER LINK] key to light up the [LINK] indicator, the [L] control adjusts the master level of both the left and right channels simultaneously.

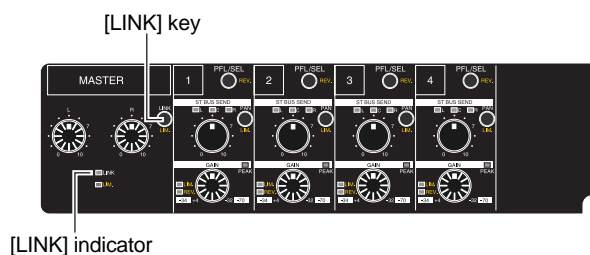

Monitoring recording signals

You can monitor recording signals via headphones or the internal monitor speaker. While a plug is inserted to the [PHONES] jack, the internal speaker automatically turns off, and you can monitor the signals only via headphones. The monitor level can be adjusted by the [MONITOR] control. This control can be pushed-lock. By pushing down the control, you can put it down to the panel height level. By pressing the control again, it comes out and you can rotate the control to adjust the level.

<Note>: By default, the internal monitor speaker is automatically muted during recording. You can select on or off of this mute function via the "Speaker mute" item in the "SYS SETUP" menu of the MENU mode (see page 159).

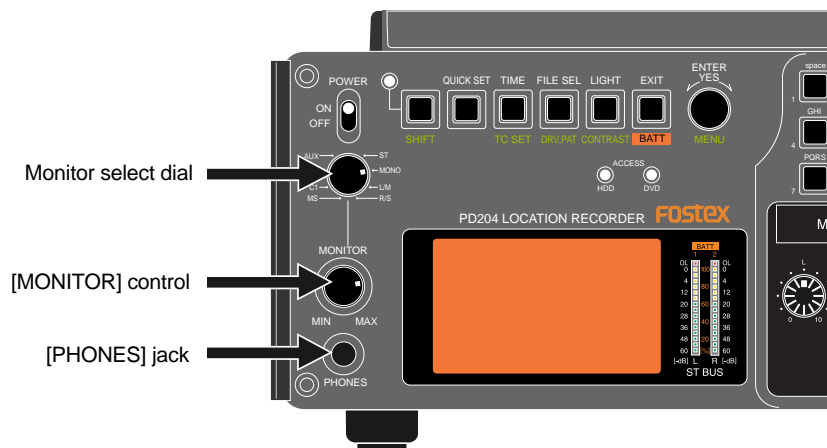

Depending on the settings of the monitor select dial, you can monitor the sound as shown on the table below.

	Record	Playback
ST	L: BUS L, R: BUS R	L: ST L, R: ST R
MONO	BUS L+R (MONO)	ST L+R (MONO)
L/M	BUS L (MONO)	ST L (MONO)
R/S	BUS R (MONO)	ST R (MONO)
M/S	L: BUS MS L, R: BUS MS R	L: ST MS L, R: ST MS R
C1	For the future expansion. No monitor signal is assigned on this version.	
C2	For the future expansion. No monitor signal is assigned on this version.	
AUX	L: AUX L, R: AUX R	L: AUX L, R: AUX R

By pressing any of the [PFL/SEL] keys on channels 1 through 4, you can monitor Pre-fader listen of the corresponding channel(s).

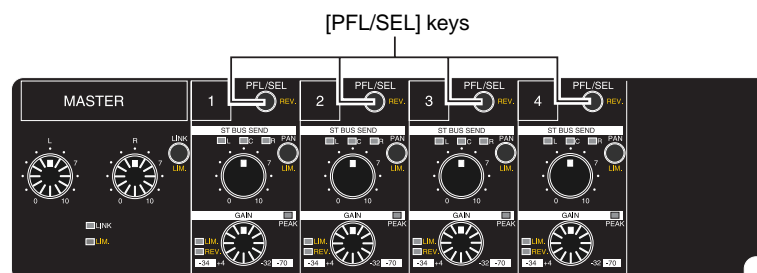

Selecting the drive for recording

The PD204 is equipped with the DVD multi drive and hard disk drive. Before recording, select the drive to which recording is made. By default, partition 1 (PT01) on the hard disk drive is selected as the current drive. To record to a DVD-RAM disk or another partition, select the desired drive by following the procedure below. In the procedure below, it is assumed that a formatted DVD-RAM disk is set to the DVD drive.

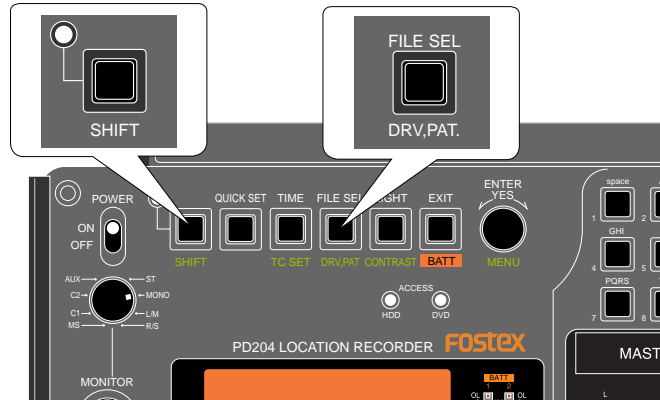

- 1) While stopped, press the [SHIFT] key to enter shift mode, followed by the [FILE SEL / DRV, PAT.] key. The display changes to show the screen for selecting a drive. On the screen, the current selection is initially highlighted.

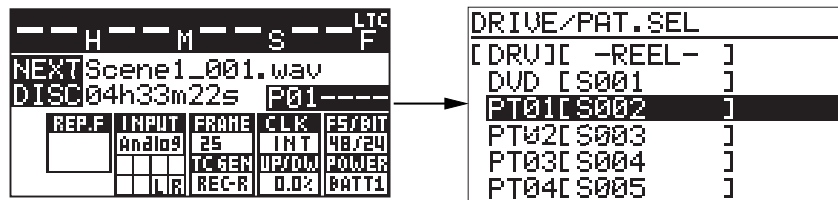

<Note>: You can also bring up the screen for selection a drive (as shown above) by the following methods.

- 1) While stopped, press the [SHIFT] key to enter shift mode, followed by the [ENTER/YES] key. The display shows the MENU list screen for selecting the desired main menu.
- 2) Use the [MENU] dial to select "DRV/PAT SEL" and press the [ENTER/YES] key. The display shows the screen for selecting a drive as above.

- 2) Use the [MENU] dial to select the desired drive (the DVD drive or a partition) and press the [ENTER/YES] key. The selected drive is loaded and the display shows the Home screen of the current drive as below (in the both examples below, no recording has been made to the current drive).

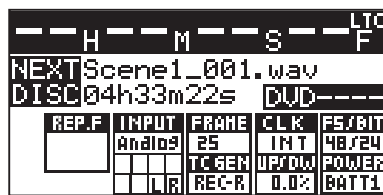

<When the DVD drive is selected>

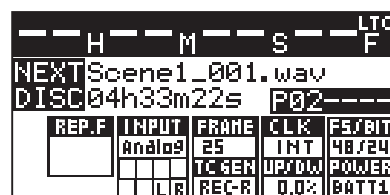

<When partition 2 is selected>

Recording analog audio

Starting recording

The following procedure assumes that all the necessary preparations for recording such as signal source connection, drive selection, level settings, etc. have been completed.

<Note>: When the unit only receives analog audio signals, you can always record analog audio signals. However, when the [DIGITAL IN] connector receives a digital signal and the unit locks to the signal, the digital signal takes priority and you cannot record the analog signals.

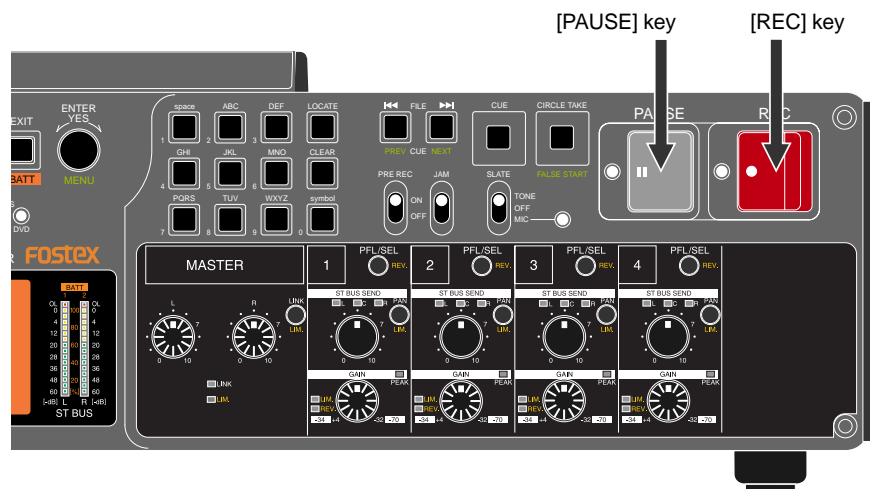

- 1) **Slide the [REC] key.**
A "New File" is automatically created and recording starts. The display changes as follows.

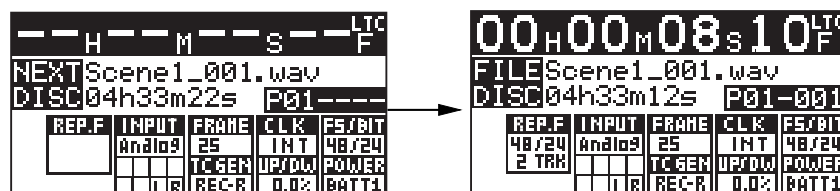

The file name given to the created audio file depends on the setting of the "Default file name" item in the "SYS SETUP" menu of the MENU mode.

- 2) **To stop recording, press the [PAUSE] key.**
During recording, only the [PAUSE] key is effective. To stop the recorder completely, press the [STOP] key after pressing the [PAUSE] key.

Note that the recorder automatically stops completely after a certain period of time since it enters the pause mode. This period is set to three minutes by default, but can be changed to a desired period between 0.1 and 9.9 minutes in 0.1 minute steps or infinity using the "Pause time" menu in the "SYS SETUP" menu of the MENU mode (see page 149).

If you press the [LOCATE] (or [STOP] + [REW]) key after stopping recording, the recorder locates to the beginning of the newly created audio file. Therefore, you can check the recorded sound by pressing the [PLAY] key in this condition.

<Note>: Every time you start recording after you stop recording, a new audio file is created and recording is made from the beginning of the new file.

About overloading during recording

While a channel receives an analog audio signal, if the input amplifier is clipped, the corresponding [OL] indicator lights in red. The [OL] indicator keeps lighting for a predetermined period set by the "Peak hold" menu item in the "SYS SETUP" menu of the MENU mode (see page 146).

By setting "Input clip" in the "Error tone" menu item to "On", the error tone is generated from the internal speaker or headphones for warning overloading. The "Error tone" menu item is found in the "SYS SETUP" menu of the MENU mode (see page 160).

<Note>: If the [MONITOR] control is set to the "MIN" position, you cannot hear the error tone.

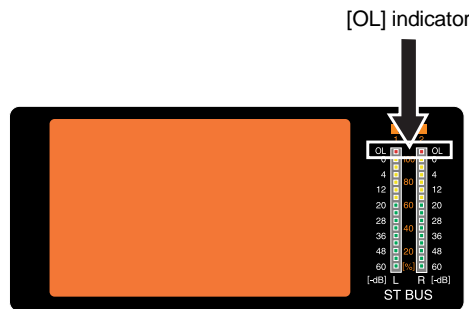

Canceling recording (False Start)

By pressing the [SHIFT] key followed by the [CIRCLE TAKE / FALSE START] key while the recorder is stopped, you can cancel the last recording.

<Note>: You can cancel only the file most recently recorded.



By pressing the [CIRCLE TAKE / FALSE START] key while the unit is in shift mode, the popup message as below appears.

If you cancel the last recording, press the [ENTER/YES] key. If you do not cancel the last recording, press the [EXIT] key.



The false start function has two mode: Rename and Delete. You can select the desired mode via the "False start" item in the "SYS SETUP" menu of the MENU mode (the default is "Rename") (see page 155 for details about how to select the mode).

In the Rename mode, the canceled audio file is stored to the DVD-RAM disk (or partition) even if you execute the false start function.

In the Delete mode, the canceled audio file is automatically deleted after you execute the false start function.

<Note>: When the mode is set to "Rename", each time you execute the false start function, the remaining recordable space is reduced. If you do not want to reduce the remaining space by executing the false start function, set the false start mode to "Delete". Note that, however, the deleted file cannot be restored.

<Note>: If an error occurs during recording, you can log the error in the diagnoses file. You can select whether or not an error is logged in the diagnoses file using the "Diagnoses" item in the "SYS SETUP" menu of the MENU mode (by default, an error is not logged). See page 145.

Recording in Pre rec mode

If you start recording with the [PRE REC] switch set to "ON", the buffered audio data is also recorded. This function may prevent you from missing the start of important recording.

The buffered time is set to 10 seconds by default, but this can be changed to desired time between 1 and 10 seconds in 1 second steps using the "Pre rec time" item in the "SYS SETUP" menu of the MENU mode (see page 151).

When you press the [PAUSE] key to stop recording, the recorder will stop after executing "post recording" which records audio data stored in the buffer.

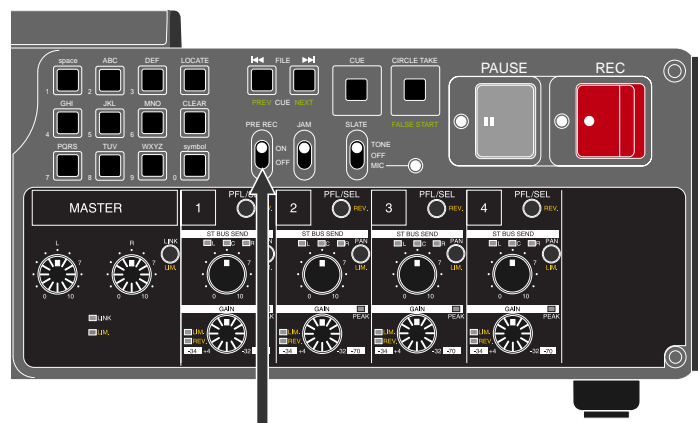

[PRE REC] switch

<Notes>

- When the [PRE REC] switch is set to "ON", the [ANALOG OUT] connectors output analog audio input signals with no delay, but output a delayed digital input signal.
- If you switch the Fs setting to "ON", wait ten seconds to start recording. Otherwise, the audio signal stored in the buffer is recorded with altered Fs.

Recording a slate tone/slate mic signal

While sliding and holding the [SLATE] switch to "TONE" or "MIC", the slate tone (at 1kHz, reference level) or the slate microphone signal is fed to all tracks, allowing you to record the slate tone or the slate microphone signal during recording.

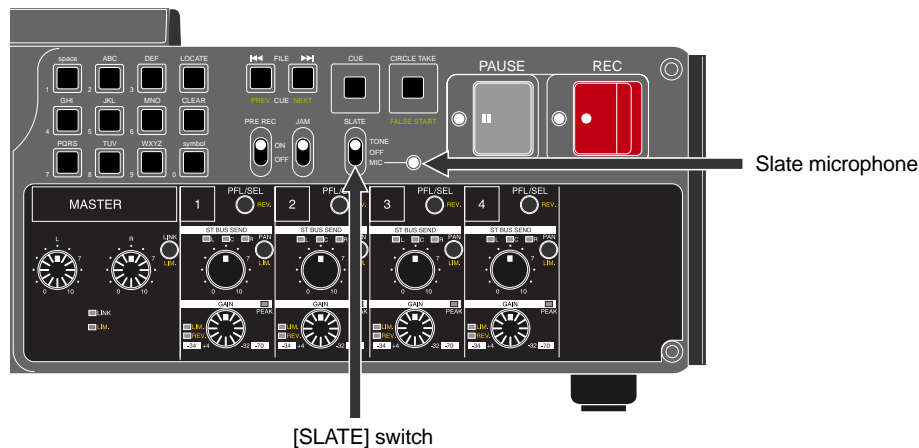

If you set the "Tone rec mode" item in the "SYS SETUP" menu of the MENU mode appropriately, the slate tone is automatically recorded at the beginning of an audio file which is created when recording is made.

You can select the slate tone type between continuous tone and 4 pop tones. For details about "Tone rec mode" menu item, see page 147.

<Notes>

- While sliding up and holding the [SLATE] switch to the "TONE" position, the slate tone is output from the [ANALOG OUT] connectors, allowing you to calibrate external devices.
- If you keep holding the [SLATE] switch for more than three seconds, the display shows "--Slate tone hold--" and the slate tone is continuously output even if you release the switch. In this condition, sliding up the [SLATE] switch again stops slate tone output.

<Hints>

Besides recording capability to a DVD-RAM disk or hard disk partition, the PD204 has the following recording capabilities.

- (1) While you make recording to a hard disk partition, you can automatically record the same materials to a DVD-RAM, DVD-R/RW or CD-R/RW disk (auto copy function). See page 104.
- (2) You can copy all recorded files between a DVD-RAM disk and a hard disk partition or between hard disk partitions (disk copy function). See page 107.
- (3) You can copy a desired file between a DVD-RAM disk and a hard disk partition or between hard disk partitions (file copy function). See page 110.
- (4) While making recording to a hard disk partition formatted in the DDR mode, you can simultaneously make recording to the mirror disk of DDR (dual drive recording). See page 113.

Recording digital audio

When recording digital audio, you do not need to make mixer settings described earlier. Instead, you have to make the following settings.

Note that time code is recorded according to the time code generator mode setting (see the next page).

<"INPUT" status indication while recording digital audio>

When a correct digital audio signal is fed to the [DIGITAL IN] connector, the PLL (Phase-locked loop) is activated and begins locking to the input signal.

When the unit locks to the digital input signal, the "INPUT" area on the display looks like the one on the left below. This indicates that the digital input takes priority and you can record the digital signal directly to the stereo tracks (L and R).

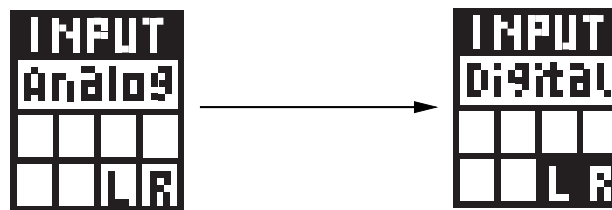

Note that the unit cannot adjust the input level when recording a digital audio signal. Adjust the external digital source level.

Selecting the sampling frequency/bit length

You can select the Fs (sampling frequency) and bit length for recording.

<Note>: The sampling frequency of the digital input signal must match the Fs/Bit setting of the PD204. You can set the Fs/Bit via the "Record FS&Bit" item in the "SYS SETUP" menu of the MENU mode (see pages 76 and 142).

Selecting the system clock

To record a digital signal, set the system clock of the PD204 to "DIGITAL" for synchronizing with an external device (by default, the system clock is set to "INT (Internal)").

When the unit receives a correct digital audio signal and locks to it, "DIGI" is shown on the Home screen. If the unit does not lock to the incoming digital signal, "DIGI" flashes.

If you want to synchronize the unit to a video or word clock, set the system clock to "VIDEO" or "WORD" appropriately.

You can select the system clock via the quick setup mode or the "Sync clock" item in the "SYS SETUP" menu of the MENU mode (see pages 75 and 175).

Recording time code

The PD204 is equipped with the internal SMPTE time code generator/reader, which is used when recording internal time code together with audio. You can also record external time code, or the internal generator time code while jamming to external time code.

Before recording time code, you must make the following settings via the "TC SETUP" menu of the MENU mode.

Selecting the TC frame rate

The frame rate of recording time code follows the setting of the unit. You can select a desired frame rate via the quick setup mode or the "Frame Rate" item in the "TC SETUP" menu of the MENU mode (see pages 75 and 176). The available frame rates are 23.976, 24, 25, 29.97, 29.97DF, 30DF and 30.

<Note>: When the frame rate is set to "29.97" (or "30DF"), the time code does not agree with clock time and slips off at the rate of 3.6 seconds per hour. Also note that, when selecting either of these frame rates, the time code continuity cannot be obtained when it passes through "24h 00m 00s 00f", according to the nature of the EIAJ format time code.

<Note>: When recording external time code, you can view the external time code value by switching the time display to "LTC IN" using the [TIME] key (see the screen example below). The external time code frame rate flashes on the right of the time display area. To record external time code, select the TC generator mode to "EXT" (see below).

Incoming time code value →

00H00M06S29^{IN}_F

NEXT Scene1_001.wav

DISC04h33m22s P01----

REF.F	INPUT	FRAME	CLK	FS/BIT
	Audio	25	INT	48/24
		TC GEN	UP/DW	POWER
	L/R	REC-R	0.0%	BATT1

← Frame rate of incoming time code

Selecting the TC generate mode (TC recording mode)

You can select the generate mode for time code recording from the following via the quick setup mode or the "Gen mode" item in the "TC SETUP" menu of the MENU mode (see pages 76 and 177).

24H RUN	Time code starts from the internal RTC (real-time clock) data.
REC RUN	When recording to a new file, the generator records time code from the value which continues to the last time code value of the previous audio file. When recording to a new disk which has no audio file, the generator records time code from the value which continues to the last time code value of the previous disk used before disk exchange.
FREE RUN	Runs the internal generator by the free run mode, and records the current internal generator time as the start time.
EXT RUN	Records an incoming external time code value as the start time.

Automatic record start by external time code

The PD204 provides the function which automatically starts recording when the unit receives external time code.

You can make this function active or inactive via the "RecIn via ExtTc" item in the "TC SETUP" menu of the MENU mode (the default is "Off"). See page 188 for details.

Off	The unit does not automatically start recording when the unit receives external time code. You must start recording manually.
On	The unit automatically starts recording when the unit receives external time code.

<Note>: To activate this function, you must set the TC generate mode to "EXT RUN".

<Note>: If the unit receives external time code whose frame rate does not match the frame rate setting of the unit when the "RecIn via ExtTc" item is set to "On", the unit does not start recording. Make sure that the frame rate setting matches the frame rate of external time code.

Setting the time code output

You can select the time code source ("Repro" or "Gen") fed from the [TIME CODE OUT] connector via the "Sel TC Out" item in the "TC SETUP" menu of the MENU mode (see page 183).

Repro	Outputs time code recorded on a disk (or partition).
Gen	Outputs the internal generator time code.

<Note>: By setting the "Sel TC out" item to "Gen", the [TIME CODE OUT] connector can output the internal generator time code when the generator mode is set to "FREE RUN", or when the generator mode is set to "REC RUN" or "24H RUN" and the unit is in recording mode.

<Note>: See "TC SETUP menu" on page 174 for details about the LTC start time, TC user bit editing, internal TC generator start time setting, the generator user bit setting, etc.

Force jam to external time code

The jam function of the PD204 internal generator allows to take over generating time code after the generator locks to the external time code timing.

Using the jam function, the PD204 time code generator can run with extreme accuracy (its own crystal accuracy) after it locks to the external time code. Therefore, you can make PD204 recording in sync with the VTR even if you disconnect the time code input after the PD204 generator locks to the external time code. In other words, you can use the PD204 away from the VTR, which is essential for location recording.

<Note>: The jam function is available only when the "TC GEN" item in the quick setup mode is set to "FREE" (FREE RUN). If you press the [JAM] key when "TC GEN" is not set to "FREE", the display shows "Void!".

REP.F	INPUT	FRAME	CLK	FS/BIT
48/24	Analog	25	INT	48/24
2 TRK		TC GEN	UP/DW	POWER
	L/R	FREE	0.0%	BATT1



- Before activating the jam function, check that the following conditions are satisfied.
 - (1) The [TIME CODE IN] connector is receiving external time code.
 - (2) The time display on the Normal screen is set to "LTC IN" and external time code value is shown.
 - (3) The external time code frame rate matches the [FRAME] setting.

Otherwise, if you try to activate the jam function, "Illegal Frame!" is shown on the display and operation is ignored.
- The following shows the basic jam operation procedure.
 - (1) **Feed external time code from a VTR, etc, to the [TIME CODE IN] connector.**
Set the "Jam mode" menu in the TC SETUP menu of the MENU mode if required (see "TC SETUP menu" page 182 for details).
 - (2) **Set the [JAM] switch to "ON".**
The display shows "--Force JAM!--" and the internal generator takes over generating time code.
 - (3) **Cut off the external time code from the [TIME CODE IN] connector.**

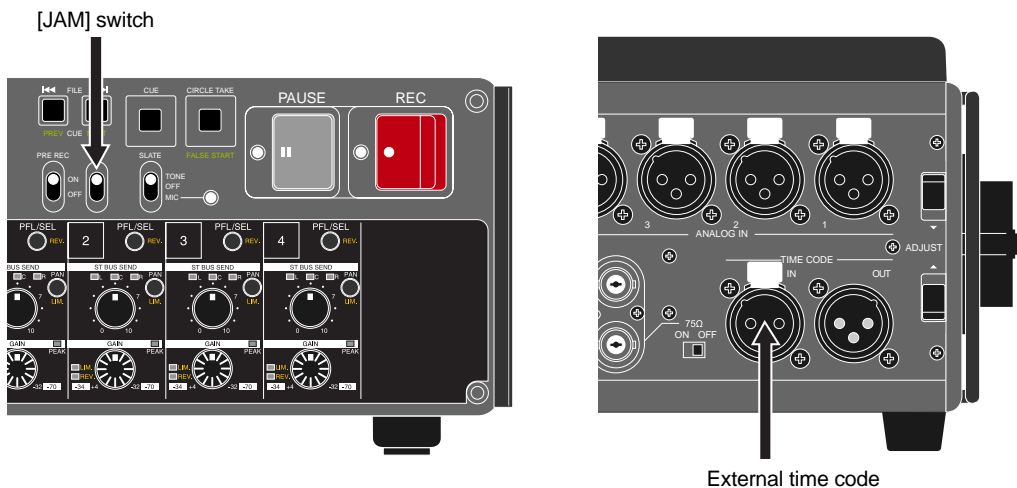

Cue point setting

The PD204 provides the following two ways of setting a cue point.

- (1) During audio recording, you can set a cue point “on-the-fly” at the desired point.
- (2) During playback or while stopped, you can set a cue point using the cue point list on the screen.

Setting a cue point on the fly during audio recording

You can set a “cue point” at the point you press the [CUE] key during recording. Up to 99 cue points can be set in a single audio file.

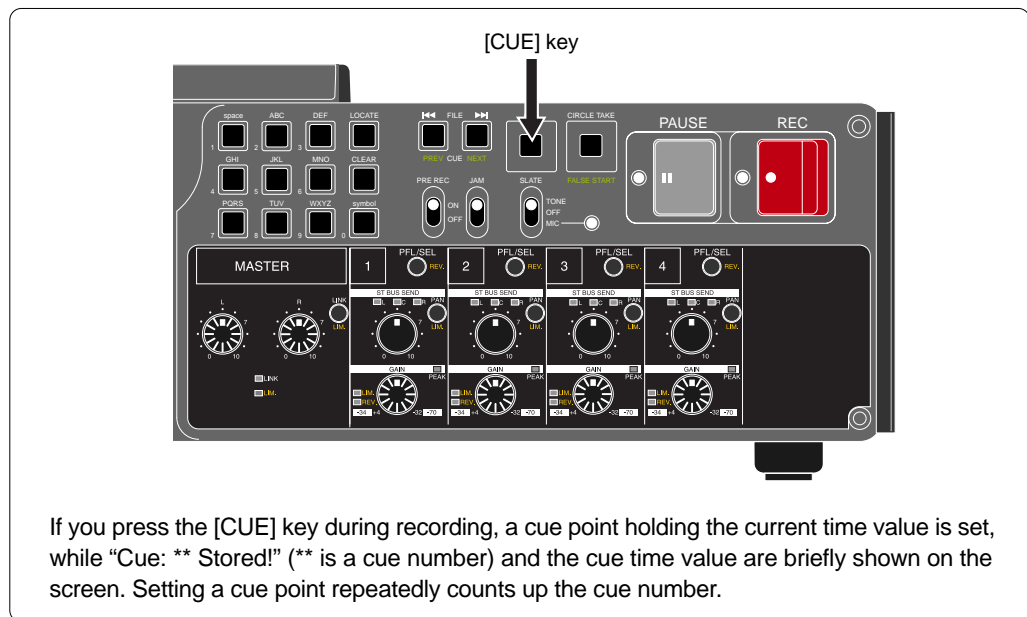

You can view cue points after recording.

Viewing the cue point list

Pressing the [CUE] key while the unit is stopped brings up the CUE LIST screen as shown below. In this screen, the existing cue points are listed. In the screen example below, cue points 01 through 04 are set, while no data is stored on and after cue point 05. The time data is shown by the format based on the time display indicator.

CUE LIST▶ (LTC)		
01	BC\$START	00h22m34
02	BC\$END	00h51m20
03	Cue 03	01h25m08
04	Cue 04	01h40m11
05		--h--m--
06		--h--m--

Labels are automatically given to the recorded CUES. “BC\$START” to CUE 01, “BC\$END” to CUE 02, and “Cue 03”, “Cue 04”... “Cue 99” to CUE 03 and the following cues. “BC\$START” and “BC\$END” are the label names reserved by the BWF-J specification. On this list screen, you can not only view cue points but also locate to a cue point, edit a cue point and add a new cue point to the list.

Editing a cue point

By selecting a desired cue point in the CUE LIST screen, you can edit its label or point (time data) or delete it.

By highlighting a desired cue point and press the [ENTER/YES] key, the display changes to show the screen for editing the selected cue point (by default, “Label” flashes on the screen).

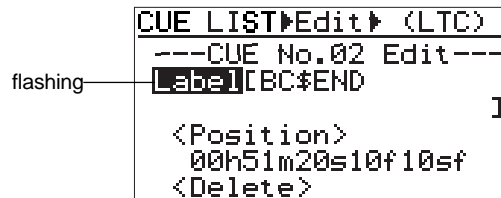

• Editing a cue label

To edit a cue point label, press the [ENTER/YES] key while “Label” flashes. The first character of the current label flashes, showing that you can now edit it. Use the [MENU] dial (or alphanumeric keys) to edit the label. After editing the label, press the [ENTER/YES] key (“Label” starts flashing again).

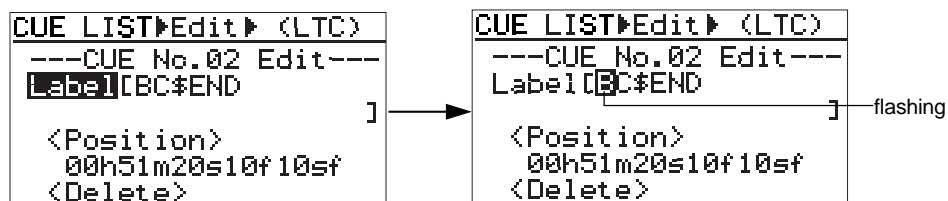

When using the alphanumeric keys for entering characters, pressing any other alphanumeric key moves the cursor to the right automatically.

You can move the cursor position using the [◀] / [▶] keys. Pressing the [CLEAR] key clears the right next character to the cursor position. To delete the whole label, press the [CLEAR] key repeatedly when the first character flashes.

• Editing cue point data

To edit a cue point data, use the [MENU] dial to select “<Position>” while “Label” is flashing and press the [ENTER/YES] key.

The subframe value of the current time data flashes, showing that you can now edit it.

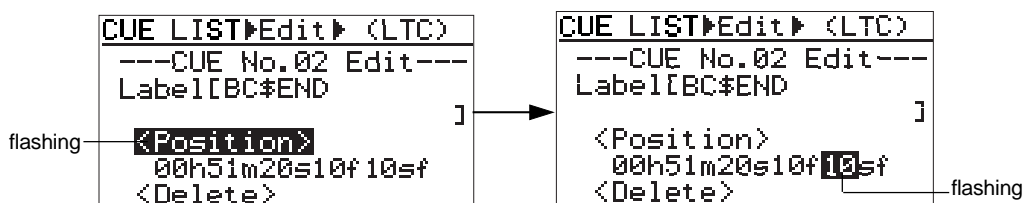

Select the edit point using the [◀] / [▶] keys, edit the value using the [MENU] dial, and confirm the setting by pressing the [ENTER/YES] key (the display returns to the CUE LIST screen).

<Note>: Regardless of the cursor position, pressing the [CLEAR] key resets the time data to “00h 00m 00s 00sf”.

• Deleting a cue point

To delete an unnecessary cue point, select “<Delete>” using the [MENU] dial and press the [ENTER/YES] key (“Sure?” flashes).

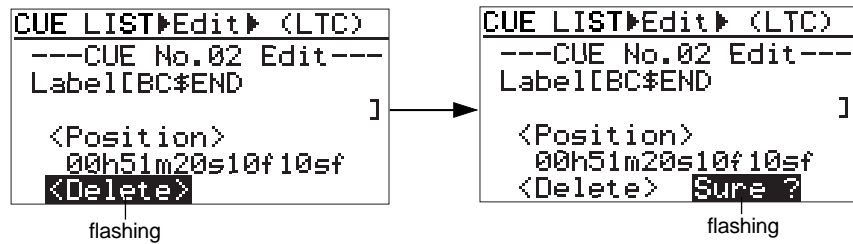

Press the [ENTER/YES] key again to delete the cue point from the list. The display returns to the home screen

<Note>: After deleting a cue point, the label column of the cue point becomes empty while the time value column shows “--h --m --s --f --sf”.

To exit the CUE LIST screen, press the [EXIT] key.

Adding a new cue point to the cue point list

While the CUE LIST screen is shown, you can add a new cue point to the list.

Select a desired cue number which does not hold data.

By pressing the [ENTER/YES] key, time data of the current recorder position is set as the cue point.

In the example below, Cue 05 is set when the current recorder position is “01h 58m 20s **f **sf” (LTC time).

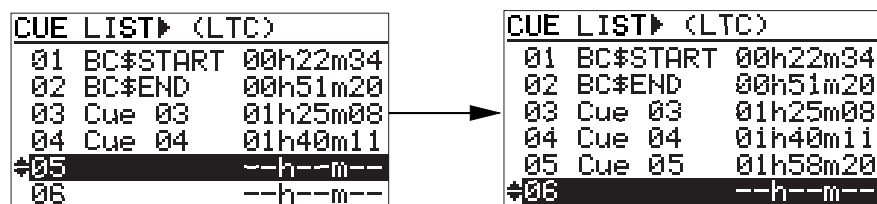

To exit the CUE LIST screen, press the [EXIT] key.

Basic playback

Normal audio playback

The following procedure assumes that an audio file is recorded to a DVD-RAM disk or hard disk partition.

- 1) Press the [SHIFT] key followed by the [FILE SEL / DRV. PAT.] key to enter drive select mode.
- 2) Use the [MENU] dial to select the desired drive and press the [ENTER/YES] key.
- 3) Select the desired audio file you want to play back using either of the following methods.

<Selecting a file using the [◀◀] / [▶▶] keys>

By pressing the [◀◀] or [▶▶] keys while the unit is stopped, you can skip backward or forward to the beginning of the previous or next audio file.

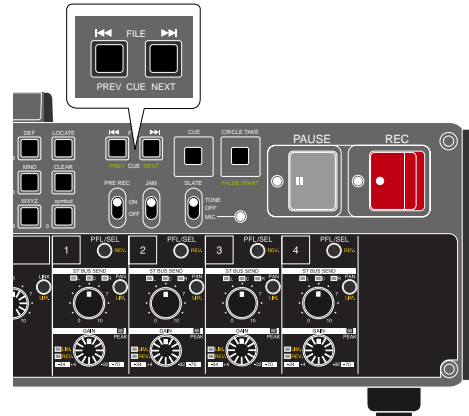

See "Skip/locate functions" on page 98 for details.

<Selecting a file from the FILE SEL screen>

While the unit is stopped, press the [FILE SEL/DRV.PAT.] key to bring up the FILE SEL screen, on which all audio files recorded to the selected drive are listed.

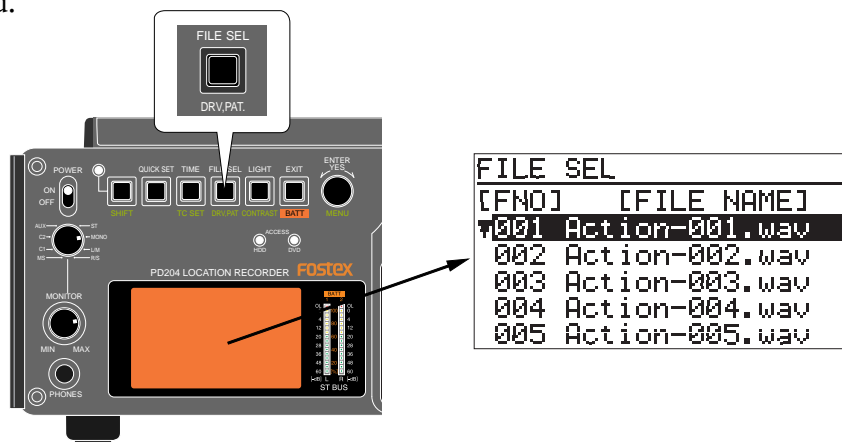

Use the [MENU] dial to select the desired audio file and press the [ENTER/YES] key.

The display shows the Home screen of the selected audio file.

4) **Press the [PLAY] key to start playback.**

The [PLAY] indicator is lit.

You can monitor the playback sound via headphones, the internal speaker or the [ANALOG OUT] connectors.

5) **To stop playback, press the [STOP] (or [PAUSE]) key.**

<Note>: While operating the unit on battery, we recommend using the [STOP] key to stop playback for saving battery power.

<Note>: If you stop playback using the [PAUSE] key, the recorder goes into pause mode. The pause mode is automatically released after the pause release time has passed and the recorder completely stops.

You can set the pause release time using the "Pause time" item in the "SYS SETUP" menu of the MENU mode. The default pause release time is three minutes (see page 149).

<Hint>

You can select how the recorder behaves after it finishes playback of an audio file, using the "Chain play" item in the "SYS SETUP" menu of the MENU mode (see page 163). By default, the recorder stops after playback ends. However, depending on your selection, it can pause at the beginning of the next audio file or continue playback of audio files one after another.

Cueing playback

In the cue mode, forward or backward cueing (at up to 2 x speed) is possible.

During playback, pressing the [F FWD] (or [REW]) key enters the cue mode and you can monitor audio at 2 x speed.

To cancel the cue mode, press the [PLAY] mode.

Time code playback

Recorded time code is played back together with audio and can be output from the [TIME CODE OUT] connector.

To output recorded time code from the [TIME CODE OUT] connector, set the "Sel. TC Out" item in the "TC SETUP" menu of the MENU mode to "Repro". By default, the "Sel. TC Out" item is set to "Repro".

If the "Sel. TC Out" item is set to "Gen", set it to "Repro" (see page 183 for details about how to set the "Sel. TC Out" item).

<Note>: If the "Sel. TC Out" item is set to "Gen", always the internal TC generator time code is output from the [TIME CODE OUT] connector.

In the "TC SETUP" menu, the following menu items regarding time code playback are available. Set these item appropriately.

- 1) **LTC start time setting ("Edit LTC start") -> page 185**
- 2) **Time code output setting in pause mode ("Pause TC") -> page 187**
- 3) **Userbit setting of repro. time code ("Rep TC Ubit") -> page 186**

Skip / locate functions

The PD204 offers comprehensive skip/locate functions.

Skipping by file

When more than one audio file is created on the current DVD-RAM disk (or hard disk partition), you can quickly skip to the beginning (ABS 0) of a desired track.

By pressing the [◀◀] or [▶▶] key while the recorder is stopped, you can skip forward or backward to the beginning (ABS 0) of the previous or next file.

Therefore, pressing the [◀◀] or [▶▶] key as many times as required skips to the beginning of the desired file.

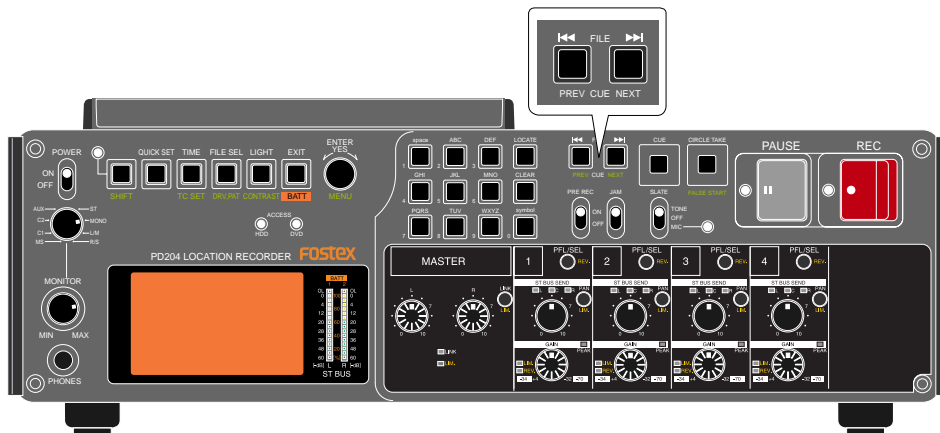

Skipping by cue point

You can quickly skip to a desired cue point on the current audio file.

By pressing the [SHIFT] key followed by the [◀◀] or [▶▶] key while the recorder is stopped, you can skip to the next or previous cue point.

Therefore, pressing the [◀◀] or [▶▶] key as many times as required skips to the desired cue point.

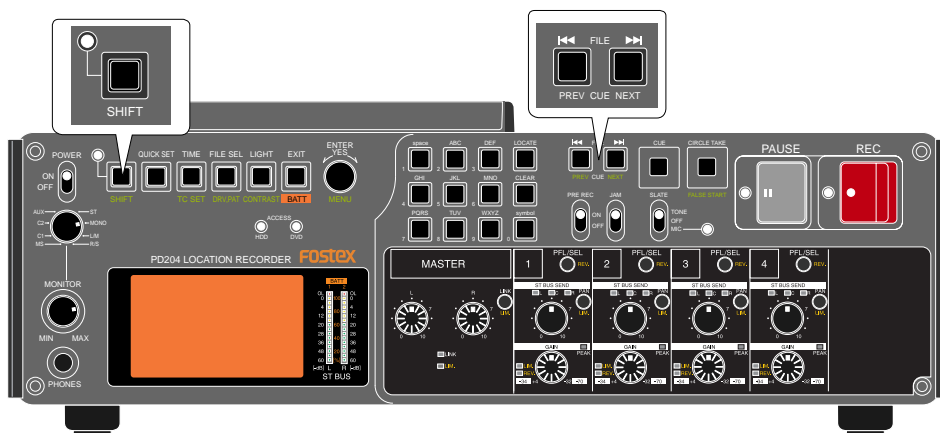

Locating to the beginning (ABS 0) of a file

While the recorder is stopped, pressing the [REW] key while holding down the [STOP] key locates to the beginning (ABS 0) of the current file quickly.

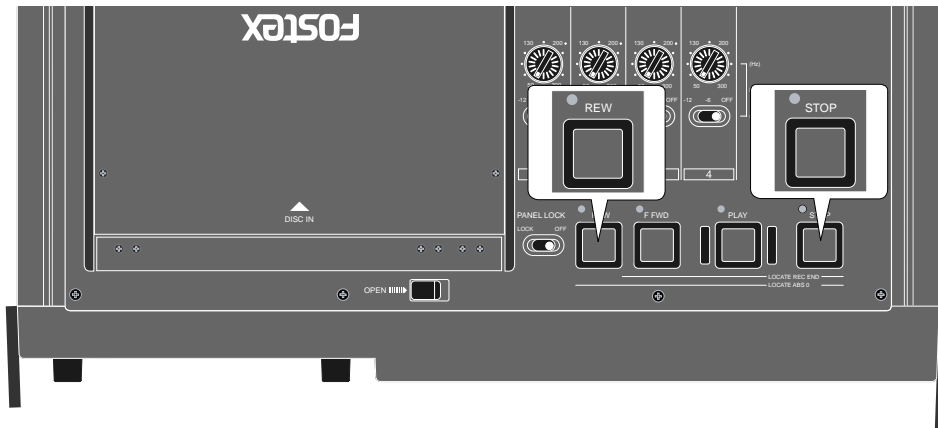

Locating to the end (REC END) of a file

While the recorder is stopped, pressing the [F FWD] key while holding down the [STOP] key locates to the record end position (REC END) of the current file quickly.

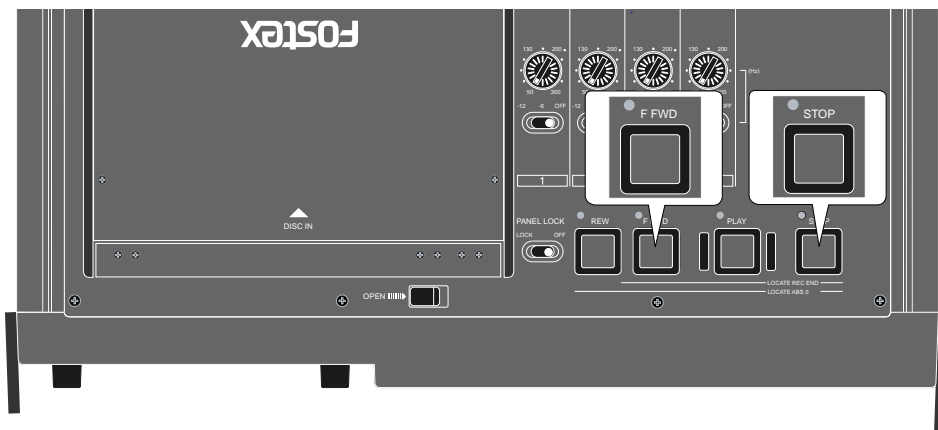

Locating to the previous locate point

While the recorder is stopped, pressing the [LOCATE] key locates to the position where you located last time.



Locating to the desired time

You can locate the recorder to the desired position by specifying the time value.

- 1) **While the recorder is stopped (or playing back), press any one of alphanumeric keys.** The unit enters time edit mode and the EDIT TIME screen pops up on the display.

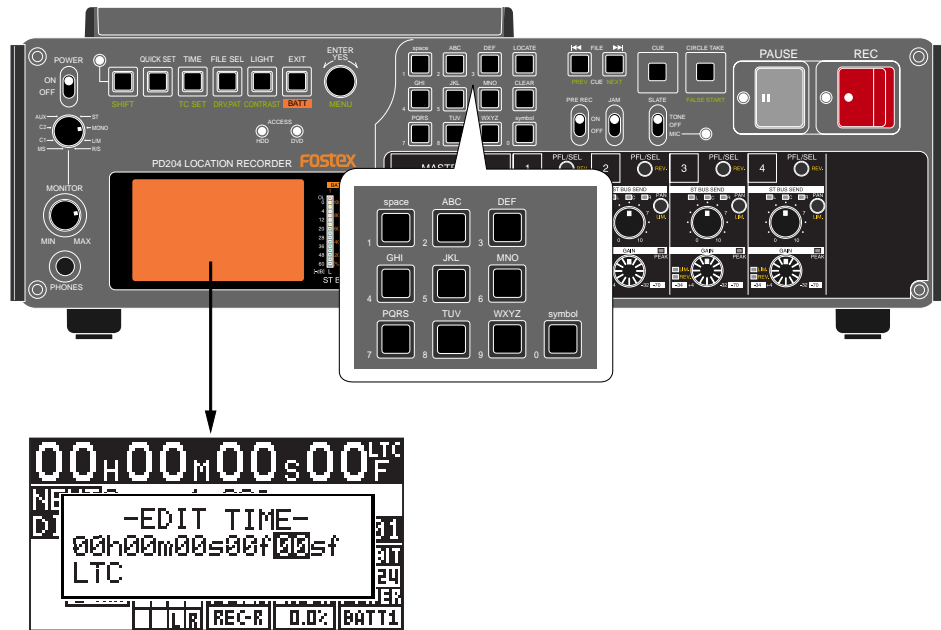

<Note>: The time value can be specified according to the time display mode selected before entering time edit mode. In the screen example above, you can specify the time value in LTC.

- 2) **Enter the desired time value using the [MENU] dial (or alphanumeric keys).** You can move the field to be edited using the [◀◀] / [▶▶] keys. Pressing the [CLEAR] key resets the time value to "00h 00m 00s 00sf".

You can enter the time value between "00h 00m 00s 00f 00sf" and "23h 59m 59s **sf" (** depends on the frame rate of the audio file).

- 3) **After entering desired time value, press the [LOCATE] key.** The recorder quickly locates to the position at the specified time.

<Note>: If you enter a time value which is out to the current file and press the [LOCATE] key, "Out of Zone" is shown and the locate operation is not executed.

Locating to the desired cue point

You can locate the recorder quickly to a desired cue point by selecting the cue point from the cue list.

- 1) While the recorder is stopped (or playing back), press the [CUE] key. The CUE LIST screen appears.

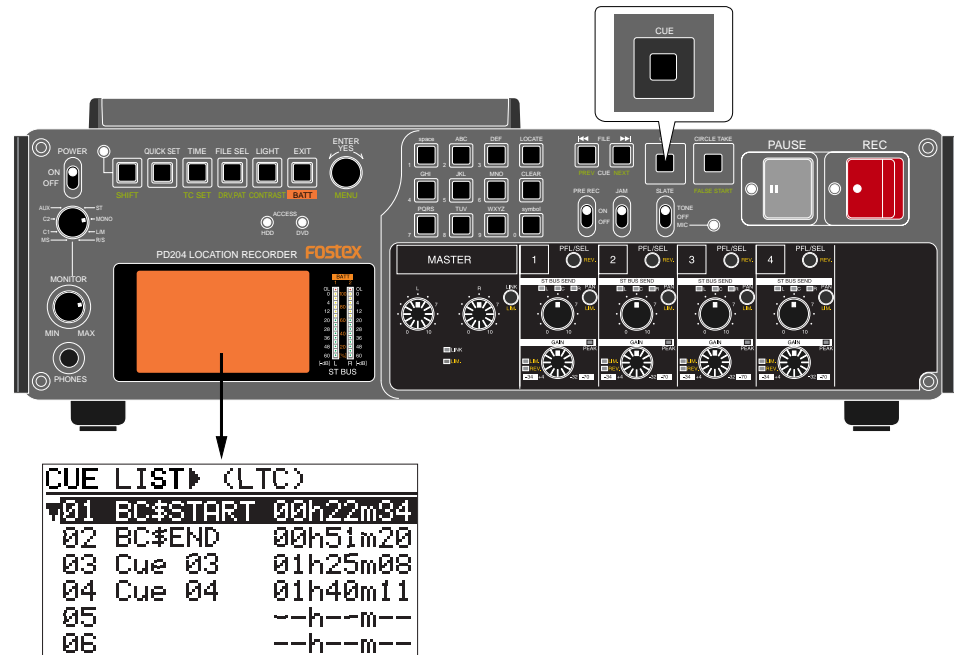

- 2) Use the [MENU] dial to select the desired cue point from the cue list, and press the [LOCATE] key. The unit quickly locates to the selected cue point and the display returns to the Home screen.

<Note>: The recorder skips to the selected cue point as with described in "Skipping by cue point" on page 98.

Chapter 6: Advanced operations

Chapter 6 - Table of contents

- Auto copy function104**
 - Selecting a partition104
 - Selecting auto copy mode105
 - Making auto copy106

- Disk copy function107**
 - Selecting source drive107
 - Making disk copy108

- File copy function110**
 - Selecting source drive110
 - Making file copy111

- Dual drive recording113**
 - Formatting in the “DDR” mode113
 - Making Dual drive recording115

- Data export to PC116**
 - Connecting PC to the unit117
 - How to unmount the PD204 from the PC117
 - Example of copying data to a computer hard disk118
 - Example of exporting data to a computer application118

Auto copy function

When recording to an audio file on a partition of the PD204 hard disk drive, the auto copy function automatically copies the same audio file to a DVD-RAM disk. You can select the auto copy mode from the following two auto copy modes.

Immediately mode	Copy recording to a DVD-RAM disk is executed simultaneously when recording to a hard disk partition. The recording size of a take is limited to the capacity of the hard disk partition or DVD-RAM disk. <Note>: In this mode, if no DVD-RAM disk is set, the PD204 cancels the auto copy mode and returns to the normal recording mode.
Back ground mode	Immediately after the PD204 ends recording to the partition and stops, the copy starts. In this mode, even if no DVD-RAM disk is set when starting recording, you can start copying by setting a disk later. <Note>: If you turn off the PD204 before setting a DVD-RAM disk, the copy data is erased.

<Note>: While the auto copy mode is “On” and a DVD-RAM disk is set to the DVD multi drive, if the partition you are going to record to is formatted in the “DDR” mode (for dual drive recording), dual recording takes priority to auto copy.

<Note>: Editing the name or meta data of the file on the partition does not reflect to the data on the DVD-RAM disk.

<Note>: Auto copy cannot be canceled by False start.

Selecting a partition

Select a partition to which audio data is recorded.

- 1) While the unit is stopped, press the [SHIFT] key to light [SHIFT] indicator, followed by the [FILE SEL/DRV.PAT] key.

The display shows the “DRIVE SEL” screen. On this screen, “DVD” represents the DVD multi drive, while “PT01” through “PT16” represent the hard disk partition.



<Note>: You can also bring up the "DRIVE SEL" screen by the procedure below.

- 1) While the unit is stopped, press the [SHIFT] key to light [SHIFT] indicator, followed by the [ENTER/YES] key.
- 2) Use the [MENU] dial to select “DRV/PAT SEL” and press the [ENTER/YES] key. The display now shows the “DRIVE SEL” screen.

- 2) Use the [MENU] dial to select the desired partition and press the [ENTER/YES] key. The display changes to show the Home screen for the selected partition. The following shows the screen example when you select unused partition 2 (P02).

-- H -- M -- S --				LTC
NEXT Scene1_001.wav				
DISC04h33m22s P02----				
REP.F	INPUT	FRAME	CLK	FS/BIT
	Audio	25	INT	48/24
		TC/GEN	UP/DW	POWER
	LR	REC-R	0.0%	BATT1

Selecting auto copy mode

You can make setting of the auto copy mode via the "Auto copy" item in the "SYS SETUP" menu of the MENU mode. The following procedure assumes that an unused DVD-RAM disk is set to the DVD multi drive.

- 1) While the unit is stopped, press the [SHIFT] key to light [SHIFT] indicator, followed by the [ENTER/YES] key. The display now shows the MENU list screen.

MENU▶	
▼SYS SETUP	▶
BATTERY SETUP	▶
TC SETUP	▶
DISK UTILITY	▶
EDIT EDL FILE	▶
USB to PC	▶

- 2) While "SYS SETUP" is highlighted, press the [ENTER/YES] key. The display now shows the SYS SETUP menu screen.

SYS▶	
▼Set project name▶	
Default file name▶	
Default Trk Name▶	
Next event No:00001	
Record FS&Bit:48k/24	
Pull up/down: 0.0%	

- 3) Use the [MENU] dial to select the "Auto copy" menu item and press the [ENTER/YES] key. The current setting flashes and you can now select the desired auto copy mode. By default, "Off" flashes.

SYS▶			SYS▶Auto copy	
Record FS&Bit:48k/24		→	Record FS&Bit:48k/24	
Pull up/down: 0.0%			Pull up/down: 0.0%	
Auto copy:Off			Auto copy:Off	Flashing
Digital out :AES/EBU			Digital out :AES/EBU	
Diagnoses:Off			Diagnoses:Off	
Peak hold :3sec			Peak hold :3sec	

You can select from among "Off", "BGRD" (Background) and "IMME" (Immediately).

- 4) Use the [MENU] dial to select the desired option and press the [ENTER/YES] key. After the display shows "Setup auto copy" followed by "Ready auto copy", the selected mode is set. In this procedure example, it is assumed that "IMME" is selected.

5) **Pressing the [EXIT] key repeatedly to exit the MENU mode.**

The display now shows the Home screen for the partition.

According to the copy mode selection in set 4) before, “Imm·C” icon (when selecting “IMME”) or “EGR·C” icon (when selecting “BGRD”) is shown on the left of the status information area.

By making the unit record ready while the auto copy mode is active, the copy source (partition) remaining time and copy destination (DVD-RAM disk) remaining time is alternately shown.

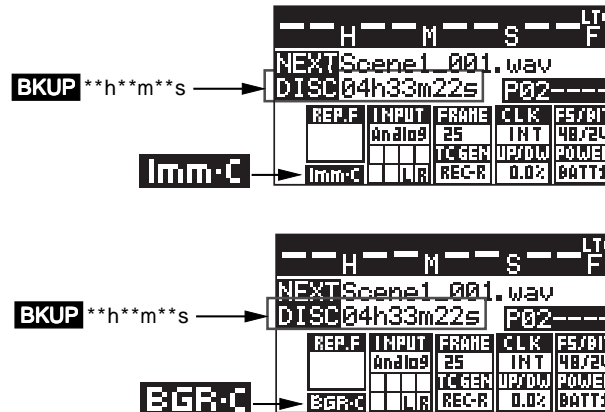

Making auto copy

1) **Slide the [REC] key to start recording to the partition.**

When the auto copy mode is set to “IMME”, audio data is recorded to the partition, while it is copied to the PD204 DVD-RAM disk.

2) **Press the [PAUSE] key to stop recording.**

If you choose the “BGRD” (Background mode) in step 4) and execute recording, auto copy actually starts when pressing the [PAUSE] key to stop recording. When starting auto copy, “Backup Copy start!” is shown on the display for a few seconds, and immediately after copy finishes, “Backup Copy Finished!” is shown.

In the “BGRD” (background mode), even if no DVD-RAM disk is set, the PD204 makes recording to the partition. In such a case, the copy data remains internally after recording to the partition finishes, therefore, auto copy is executed when setting a blank DVD-RAM disk.

<Note>: If you execute auto copy without setting a copy destination (blank DVD-RAM) disk, the copy data remains until turning off the unit.

However, once you turn off the unit, the copy data is erased and the unit does not execute auto copy.

<Note>: If you do not need to make auto copy, set the “Auto copy” menu item back to “Off”.

Disk copy function

The disk copy function fully copies all audio files recorded on a DVD-RAM disk (or hard disk partition) to another DVD-RAM disk (or hard disk partition).

To execute the disk copy function, use the “Disk copy” menu item in the “DISK UTILITY” menu of the MENU mode.

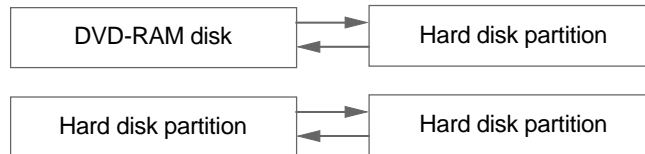

<Note>: You cannot make disk copy using a DVD-R, DVD-RW, CD-R or CD-RW disk.

Selecting source drive

Before executing disk copy, select the desired copy source as the current drive (DVD multi drive or a hard disk partition).

- 1) While the unit is stopped, press the [SHIFT] key to light [SHIFT] indicator, followed by the [FILE SEL/DRV.PAT] key.

The display shows the “DRIVE SEL” screen. In this screen, “DVD” represents the DVD multi drive, while “PT01” through “PT16” represent the hard disk partition.



<Note>: You can also bring up the “DRIVE SEL” screen by the procedure below.

- 1) While the unit is stopped, press the [SHIFT] key to light [SHIFT] indicator, followed by the [ENTER/YES] key.
 - 2) Use the [MENU] dial to select “DRV/PAT SEL” and press the [ENTER/YES] key. The display now shows the “DRIVE SEL” screen.
- 2) Use the [MENU] dial to select the desired partition and press the [ENTER/YES] key. The display changes to show the Home screen for the selected partition.

Making disk copy

The following procedure assumes that partition 1 (PT01) is selected as the current drive and you attempt to copy audio data recorded on the partition to the DVD-RAM disk.

- 1) While the unit is stopped, press the [SHIFT] key to light [SHIFT] indicator, followed by the [ENTER/YES] key.

The display now shows the MENU list screen.

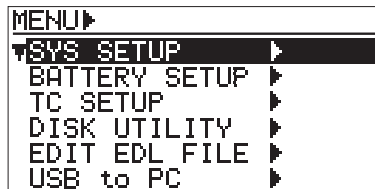

- 2) Use the [MENU] dial to select “DISK UTILITY” and press the [ENTER/YES] key.

The display now shows the DISK UTILITY menu screen.

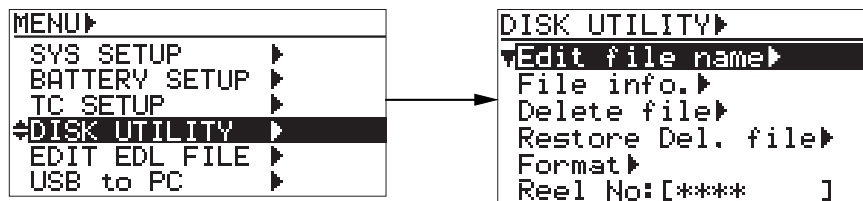

- 3) Use the [MENU] dial to select the “Disk copy” menu item and press the [ENTER/YES] key.

The display now shows the screen for selecting the drive of the copy destination. The default setting “DVD” is flashing.

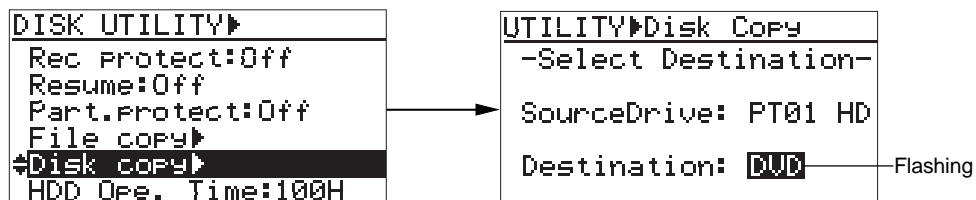

- 4) While “DVD” is flashing, press the [ENTER/YES] key.

The display now shows the screen for selecting the copy mode.

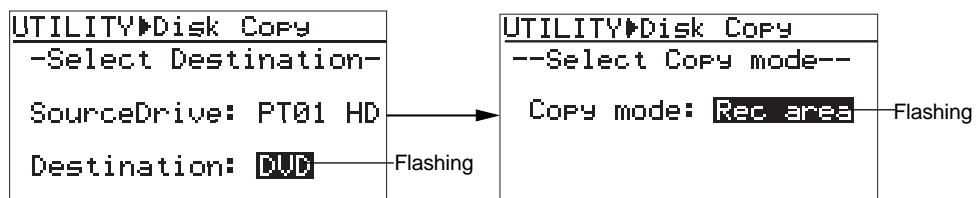

Options	
Rec area	Copies only the recorded area at high speed. (default).
Full area	Copies the whole UDF-formatted area.

- 5) **Use the [MENU] dial to select the “Copy mode” item and press the [ENTER/YES] key.**
The display shows the “---CAUTION---” message on which “Are you sure?” flashes, as shown below. In the bottom of this message screen, the approximate time required for disk copy is shown.

```

---CAUTION---
If ENTER key is push
-ed, will start Disk
Copying and delete
DVD-RAM area data.
Are you sure?
Finish time: 01M13S

```

Flashing

<Note>: You cannot select the disk copy destination to the same medium as the copy source. If you do so, the display shows “Void!” and returns to the screen for selecting the copy destination medium.

- 6) **If you are sure, press the [ENTER/YES] key.**
The PD204 starts disk copy to the selected destination medium. During disk copy, the display shows estimated time and space remaining progress indication for disk copy. When disk copy completes, “Completed!” is shown on the display and the PD204 stops disk access.

```

UTILITY▶Disk Copy
PT01HD >>> DVD
Finish: ***M**S
Remain: **** Mbyte
0          50          100%
█

```

- 7) **Pressing the [EXIT] key repeatedly to exit the MENU mode.**

File copy function

The file copy function copies an audio file recorded on a DVD-RAM disk (or hard disk partition) to another DVD-RAM disk (or hard disk partition). To execute the file copy function, use the “File copy” menu item in the “DISK UTILITY” menu of the MENU mode.

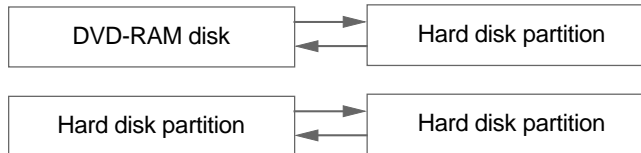

<Note>: You can make file copy to a DVD-R, DVD-RW, CD-R or CD-RW disk, as well as a DVD-RAM disk. However note that you cannot use DVD-R/RW and CD-R/RW discs for normal recording. You can use them only when you make audio file copy from a hard disk partition. Also note that you cannot make file copy to a recorded DVD-R/RW or CD-R/RW disk because file copy to a disk is made in disc-at-once mode.

<Note>: When you select a hard disk partition as the copy destination, you cannot make file copy from a DVD-R/RW or CD-R/RW disk, though you can do it from a DVD-RAM disk.

Selecting source drive

Before executing file copy, select the desired copy source as the current drive (DVD multi drive or a hard disk partition).

<Important note>: When you execute file copy to a DVD-R/RW or CD-R/RW disk, you must select a hard disk partition as the current drive before you set a DVD-R/RW or CD-R/RW disk.

- 1) While the unit is stopped, press the [SHIFT] key to light [SHIFT] indicator, followed by the [FILE SEL/DRV.PAT] key.

The display shows the “DRIVE SEL” screen. In this screen, “DVD” represents the DVD multi drive, while “PT01” through “PT16” represent the hard disk partition.



<Note>: You can also bring up the "DRIVE SEL" screen by the procedure below.

- 1) While the unit is stopped, press the [SHIFT] key to light [SHIFT] indicator, followed by the [ENTER/YES] key.
- 2) Use the [MENU] dial to select “DRV/PAT SEL” and press the [ENTER/YES] key. The display now shows the “DRIVE SEL” screen.

- 2) Use the [MENU] dial to select the desired drive and press the [ENTER/YES] key. The display changes to show the Home screen for the selected partition.

Making file copy

The following procedure assumes that partition 1 (PT01) is selected as the current drive and you attempt to copy audio files recorded on the partition to the DVD-RAM disk.

- 1) While the unit is stopped, press the [SHIFT] key to light [SHIFT] indicator, followed by the [ENTER/YES] key.

The display now shows the MENU list screen.

```

MENU▶
▼SYS SETUP ▶
BATTERY SETUP ▶
TC SETUP ▶
DISK UTILITY ▶
EDIT EDL FILE ▶
USB to PC ▶
  
```

- 2) Use the [MENU] dial to select “DISK UTILITY” and press the [ENTER/YES] key.

The display now shows the DISK UTILITY menu screen.

```

MENU▶
SYS SETUP ▶
BATTERY SETUP ▶
TC SETUP ▶
◀DISK UTILITY ▶
EDIT EDL FILE ▶
USB to PC ▶
  
```

→

```

DISK UTILITY▶
▼Edit file name▶
File info.▶
Delete file▶
Restore Del. file▶
Format▶
Reel No:[***** ]
  
```

- 3) Use the [MENU] dial to select “File copy” and press the [ENTER/YES] key.

The display now shows the screen for selecting the copy destination.

The default setting “DVD” is flashing.

```

DISK UTILITY▶
Reel No:[S001 ]
Rec protect:Off
Resume:Off
Part.Protect:Off
◀File copy▶
Disk copy▶
  
```

→

```

UTILITY▶File Copy
-Select Destination-
SourceDrive: PT01 HD
Destination: DVD
  
```

Flashing

- 4) While “DVD” is flashing, press the [ENTER/YES] key.

The display now shows the screen for selecting the desired audio file from those recorded on the hard disk partition 1 (PT01).

```

UTILITY▶File Copy
Push FILE SEL key
▼001 file name
002 file name
003 file name
004 file name
<All Select>
  
```

<Note>: You cannot select the file copy destination to the same medium as the copy source. If you do so, the display shows “Void!” and returns to the screen for selecting the copy destination medium.

- 5) Use the [MENU] dial to select the desired audio file(s) to be copied, and press the [FILE SEL] key.

The audio file to be copied is selected and a checkmark is placed to the left of its name. You can select more than one audio file by repeating the operation above.

To deselect an audio file, select the file with a checkmark and press the [FILE SEL] key again.

If you select "<All Select>" at the bottom of the file list on the screen and press the [FILE SEL] key, all audio files are selected and checkmarked.

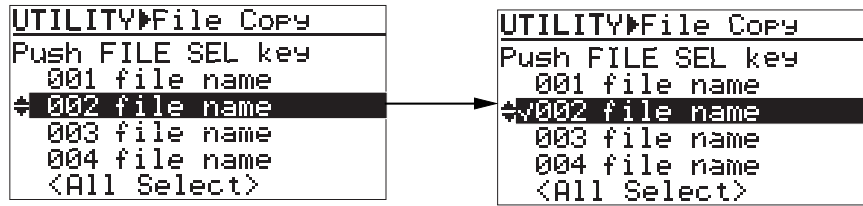

6) After making audio file selection, press the [ENTER/YES] key.

The PD204 starts file copy to the destination medium (DVD-RAM disk or partition). During file copy, the display shows estimated time and space remaining progress indication for file copy. When file copy completes, "Completed!" is shown on the display and the PD204 stops disk access.

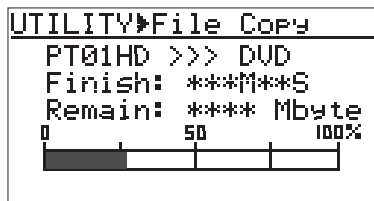

<Note>: If the available recording space of the copy destination is smaller than the copy source size, "Over copy size!" is shown and the display returns to the previous screen for selecting an audio file.

<Note>: After file copy to a DVD-R/RW or CD-R/RW is completed, the disk is automatically finalized. While finalizing the disk, the popup screen as shown below appears. When you copy an audio file whose size is less than 1GB to a DVD-R/RW disk, the unit must write readout area from the center of the disk to the 70mm diameter position, resulting longer finalizing time. We recommend using a CD-R/RW disk when you make a file copy of an audio file whose size is less than 650 MB.

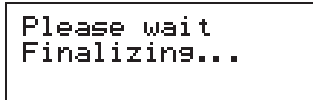

7) Pressing the [EXIT] key repeatedly to exit the MENU mode.

<Note>: If you set a recorded DVD-R/RW or CD-R/RW disk to the copy destination, the display shows "Write protected!" or "No Blank disk". In such a case, do the following.

- **When a recorded DVD-R or CD-R disk is set:**
After briefly showing "Write protected!", the display shows the screen for selecting the drive of the copy destination. Change the disk.
- **When a recorded DVD-RW or CD-RW is set:**
After briefly showing "No Blank disk", the display shows the popup screen as below. If you erase the disk, press the [ENTER/YES] key. If you do not erase the disk, press the [EXIT] key. If erasing the disk is properly completed, the display automatically returns to the execution screen for disk copy.

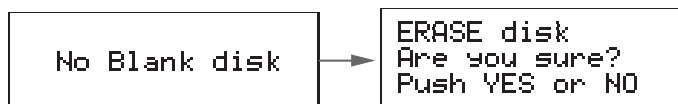

Dual drive recording

Dual drive recording is a special function which simultaneously records the same data to a “mirror” DVD-RAM disk (*) while recording audio data to a hard disk partition specially formatted for “dual drive recording”.

Dual drive recording intends to make a clone disk. Therefore, editing meta data or disk volume label (reel No.) of an audio file recorded to a hard disk partition is reflected to a “mirror” DVD-RAM disk.

(*) About “mirror” disk

A DVD-RAM disk which is the partner of the current drive formatted for “dual drive recording” is called a “mirror disk”.

When formatting the PD204 internal hard disk partition for “dual drive recording”, a DVD-RAM disk set to the DVD-RAM drive is automatically assigned as a “mirror disk”. Therefore, when making dual drive recording, the “mirror disk” must be set to the drive.

<Note>: You cannot record data only to the mirror disk.

To make it possible to record data only to the mirror disk, reformat the current hard disk partition for normal recording via the “Format” menu item in the “DISK UTILITY” menu of the MENU mode.

The following explains how to format a partition for dual drive recording and how to make dual drive recording.

Formatting in the “DDR” mode

To carry out dual drive recording, you have to format the current partition in the “DDR” mode for dual drive recording. The following procedure is assumed that the “PT02HD” hard disk partition is currently selected (see page 112 for details about how to select a partition).

- 1) While the unit is stopped, press the [SHIFT] key to light [SHIFT] indicator, followed by the [ENTER/YES] key.

The display now shows the MENU list screen.

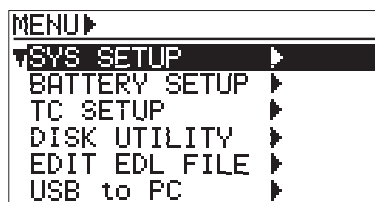

- 2) Use the [MENU] dial to select “DISK UTILITY” and press the [ENTER/YES] key.

The display now shows the DISK UTILITY menu screen.

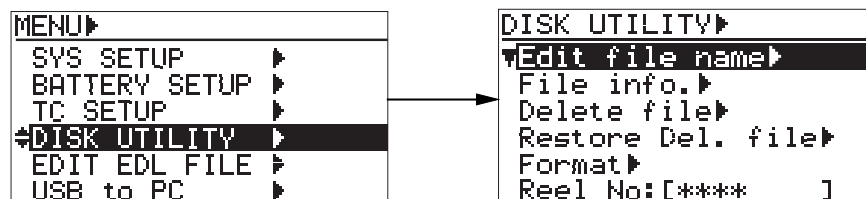

- 3) Use the [MENU] dial to select “Format” and press the [ENTER/YES] key.

The display now shows the screen for format setting.

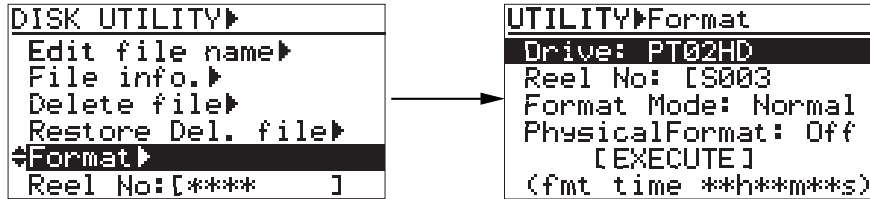

In this procedure example, we assume that we format partition 2 (PT02) which is the current drive in the "DDR" mode. If you want to format another partition, press the [ENTER/YES] key while "Drive: PT02HD" is highlighted and select the desired partition.

In this procedure, we assume that we use the default reel number (volume label) which is "S003", and skip to the format mode selection. (If you want to change the reel number later, you can do it using the "Reel No" menu item in the "DISK UTILITY" menu of the MENU mode.)

- 4) Use the [MENU] dial to select "Format mode" and press the [ENTER/YES] key.

The current format mode ("Normal" on the screen below) flashes. You can now select the desired mode.

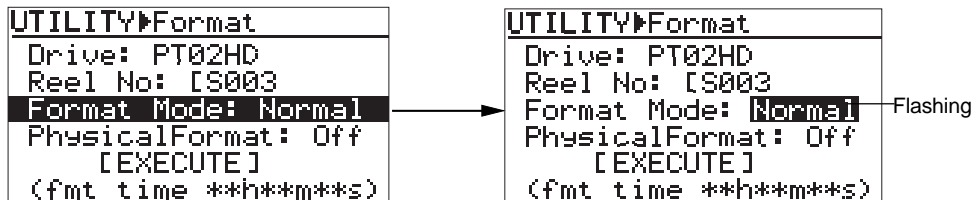

- 5) Use the [MENU] dial to select "DDR" and press the [ENTER/YES] key.

The format mode is set to "DDR" and the display changes to the screen on the right below. In this procedure, we assume that we format the drive with the "Physical Format" set to "Off".

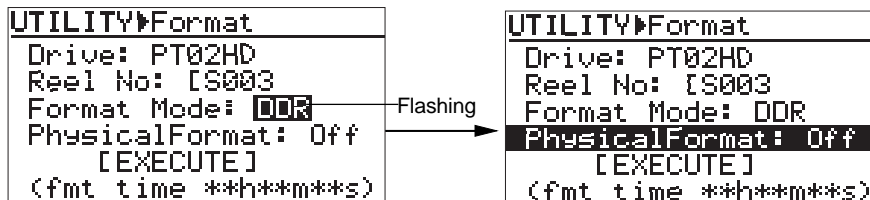

- 6) Use the [MENU] dial to select "[EXECUTE]" and press the [ENTER/YES] key.

The display shows the caution message before executing formatting.

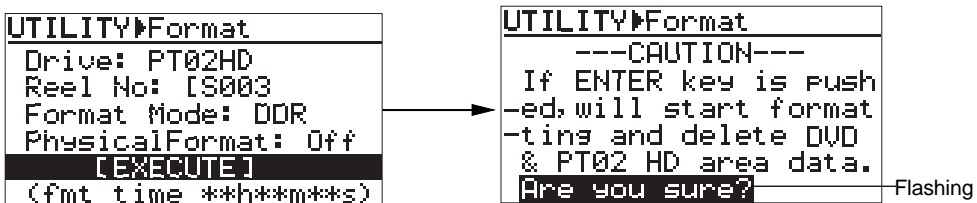

- 7) If you are sure, press the [ENTER/YES] key to execute formatting.

The display now shows the formatting progress indication. When formatting completes, "Completed!" is shown.

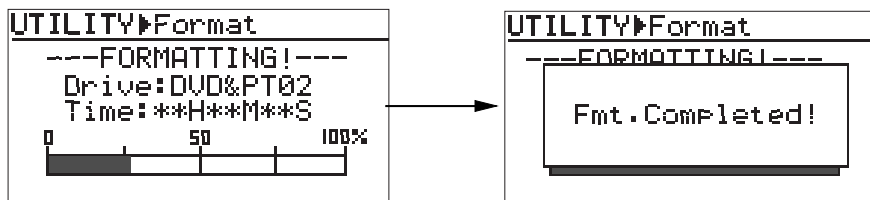

8) Pressing the [EXIT] key repeatedly to exit the MENU mode.

After exiting the MENU mode, the display returns to the Home screen of the formatted partition (PT02, in this procedure example), while the unit scans the mirror disk.

On the Home screen of a DDR-formatted partition, "DDR-m" flashes.

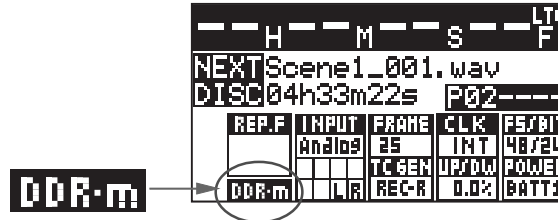

Making dual drive recording

The following procedure is assumed that the selected partition (PT02) is “DDR” formatted and a mirror disk is set to the DVD multi drive.

<Note>: To execute dual drive recording, you must set a mirror disk to the DVD-RAM disk drive. If a wrong disk is set to the DVD-RAM disk drive or no disk is set, the PD204 detects an error when scanning the mirror disk, and shows a caution message (“Difference! DDR mirror disk”, etc). When it scans a correct mirror disk, “Presence! DDR mirror disk” is shown.

<Note>: When starting dual drive recording, if the current drive is “Normal” formatted, switch to a “DDR” formatted hard disk partition and set a mirror disk to the DVD-RAM drive. On the screen for selecting a drive, “DDR” is placed on the right of the name of the “DDR” formatted partition. So you can easily distinguish them.

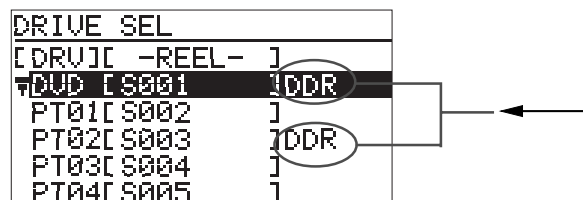

1) Slide the [REC] key to start recording to the partition.

Dual drive recording starts.

The PD204 also make recording to the mirror disk in the background, as well as recording to partition 2 (“PT02”).

2) After completing recording, press the [PAUSE] key to stop recording.

If recording has not been successfully made, immediately cancel by the “False start” function and make recording again.

Data export to PC

By connecting the PD204 to a personal computer via the [USB PC] connector, audio file data can be transferred. PD204 audio data can be copied to hard disk on the personal computer, or exported to an application software such as Digidesign Pro Tools.

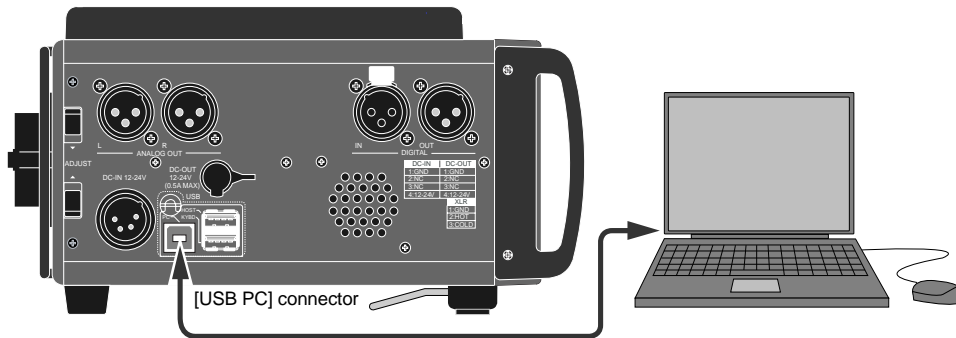

<Note>: For the stable operation, the length of a USB cable for connection between the PD204 and a personal computer should be less than three meters. If you use a longer USB cable, we do not guarantee the stable data transfer operation.

<Note>: When you connect the PD204 to a personal computer using the [USB PC] port, do not connect any device to the [USB HOST] port.

<Note>: Depending on your computer OS, the read/write functions may be limited as below.

- Windows XP, Windows 2000, Vista: Only "Read" is possible (no driver software or commercially available writing software required).
* Write data from the personal computer is possible only on the DVD-RAM disk.
- Macintosh OS 9.2.2: Only "Read" is possible (no driver software or commercially available writing software required).
- Macintosh OS X: Only "Read" is possible (no driver software or commercially available writing software required).

* All company names and model names mentioned in this manual are trademarks or registered trademarks of their respective holders.

<Note>: The procedure of access to a DVD-RAM disk or the internal hard disk drive differs depending on the port you use and the OS of your PC. Note that you can read data on the internal hard disk drive from your PC but cannot write data to it.

Also note that, with some writing software applications in the market, the file transfer speed from the hard disk drive may be extremely slower than the file transfer speed from a DVD-RAM disk. In such a case, the transfer speed may be improved by disabling the packet write function of the writing software application (see the operation manual of the writing software application for details about the packet write function),

<Note>: Most PC applications can import an interleaved file directly, however, if you cannot export an interleaved file to your PC application, use Fostex BWF Manager to convert the file to mono files. Mono BWF files converted using the BWF Manager can be imported and edited by an audio software application. An interleaved BWF file converted from mono files can be played back by the PD204 or DV824. You can download "BWF Manager" from the Fostex website (<http://www.fostexinternational.com/>).

Connecting PC to the unit

After connecting the cable between the unit and a PC using a USB cable, make USB connection using the "USB to PC" menu of the MENU mode.

<Note>: If you make USB connection between the PD204 and your personal computer while a recorded disk is set to the DVD drive, you can see two icons (for the DVD multi drive and the selected partition) on your computer. If no disk is set to the DVD multi drive, only the icon for the selected partition is shown.

- 1) While the unit is stopped, press the [SHIFT] key to light [SHIFT] indicator, followed by the [ENTER/YES] key.
The display now shows the MENU list screen.

```

MENU▶
  USB SETUP ▶
  BATTERY SETUP ▶
  TC SETUP ▶
  DISK UTILITY ▶
  EDIT EDL FILE ▶
  USB to PC ▶
  
```

- 2) Use the [MENU] dial to select "USB to PC" and press the [ENTER/YES] key.
The display now shows the screen for USB connection. You can select a partition on this screen.

<pre> MENU▶ BATTERY SETUP ▶ TC SETUP ▶ DISK UTILITY ▶ EDIT EDL FILE ▶ USB to PC ▶ RS422 SETUP ▶ </pre>	→	<pre> MENU▶USB to PC Connect USB? Sel. Partiton PT01 [S002] Yes :ENTER key No :EXIT key </pre>	Flashing
--	---	---	----------

- 3) Use the [MENU] dial to select the desired partition and press the [ENTER/YES] key.
USB connection between the PD204 and personal computer is made, while the display changes to the screen as shown right below.
On the computer display, two icons (for the DVD drive and the selected partition) are shown.

<pre> MENU▶USB to PC Connect USB? Sel. Partiton PT01 [S002] Yes :ENTER key No :EXIT key </pre>	→	<pre> MENU▶USB to PC -- Connecting -- Disconnect USB? Partiton PT01 [S002] Yes :EXIT key </pre>	Flashing
---	---	--	----------

You can transfer data between the PD204 and computer while the screen on the right above is shown.

How to unmount the PD204 from the PC

To disconnect the PD204 from the personal computer, unmount the PD204 drive(s) from the computer and remove the USB cable, then press the [EXIT] key to disconnect USB. The method of unmounting a device from a computer differs depending on the computer OS. See the computer operation manual for details.

<Note>: Depending on the OS, the unmounted device may be immediately mounted again. Therefore, to stop using "USB to PC" menu, disconnect the cable immediately after unmounting the unit.

Example of copying data to a computer hard disk

In the following procedure, we assume that the cable between the PD204 and the PC is connected and the “USB to PC” menu item in the “SYS SETUP” menu of the MENU mode is set to “CONNECT”.

<Note>: While the "USB to PC" screen shows "Connecting", the keys and dial on the PD204 are disabled. If you operate any key/dial, the popup message shown on the right appears for warning.

-Connected USB-

- 1) **Make sure that the PD204 drive (or partition) icon appears on the desktop of your computer (note that the icon looks differently depending on the personal computer).**
- 2) **Start up an appropriate application such as Explorer on the computer, and copy an audio data file in the PD204 drive (or partition) to the computer hard disk.**

Example of exporting data to a computer application

The procedure example below shows how to export PD204 data to Digidesign Pro Tools for Macintosh. For details about operations of Pro Tools, see the instructions supplied with Pro Tools. Note that the screen examples below may look different from the screen you actually see. Also note that the procedure below is assumed that the PD204 is connected to the PC (Macintosh) and the “USB to PC” menu in the “SYS SETUP” menu is set to “CONNECT”.

- 1) **Start up the application software (Pro Tools, in this example).**
- 2) **Click on “Audio” on the Pro Tools screen to pop up the audio region list menu (indicated by an arrow 1).**
- 3) **Select and click on the “Import Audio” menu from the popup menu (indicated by an arrow 2).**

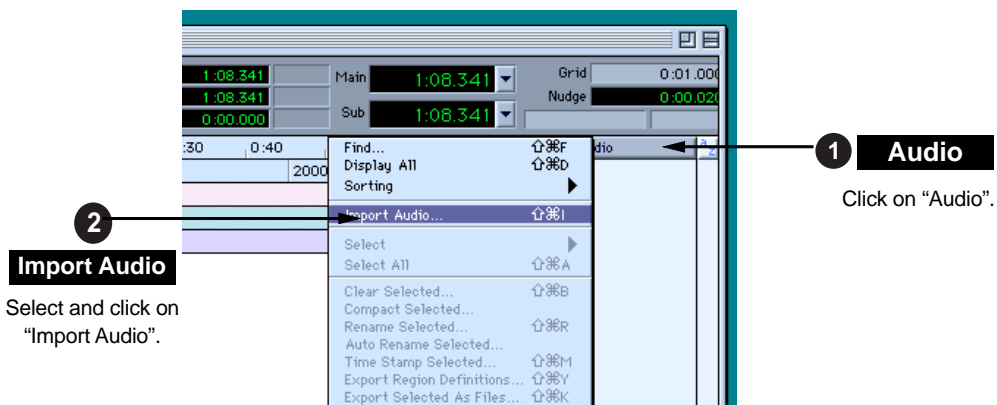

- 4) **Select and click on “DVD drive” (or partition) on the desktop (indicated by an arrow 3).** The disk volume label in the example shown on the next page shows the default tentative name. If you edit the volume label (Reel Number) in the process of disk formatting, the edited volume label is shown.



- 5) **Select and click on an audio file in the “bwff” directory on the disk (indicated by an arrow 4).**
The selected audio file is shown in “Region in current file”.
- 6) **Click on “Convert ->”, followed by “Done” (indicated by an arrow 5).**
The display shows the window for saving a file.

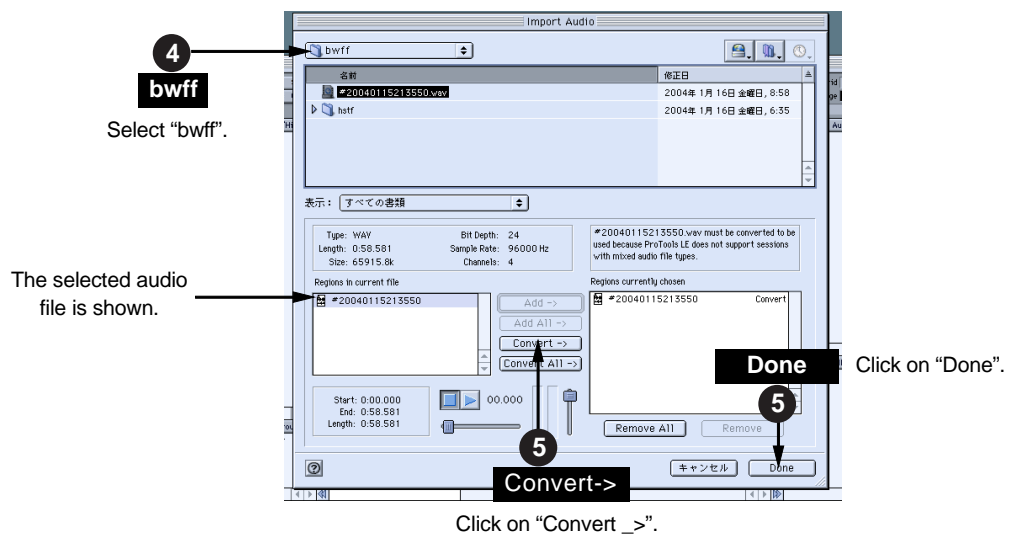

- 7) **Select a saving file and click on “Select” (indicated by an arrow 6).**
The computer starts saving the file to the selected file.

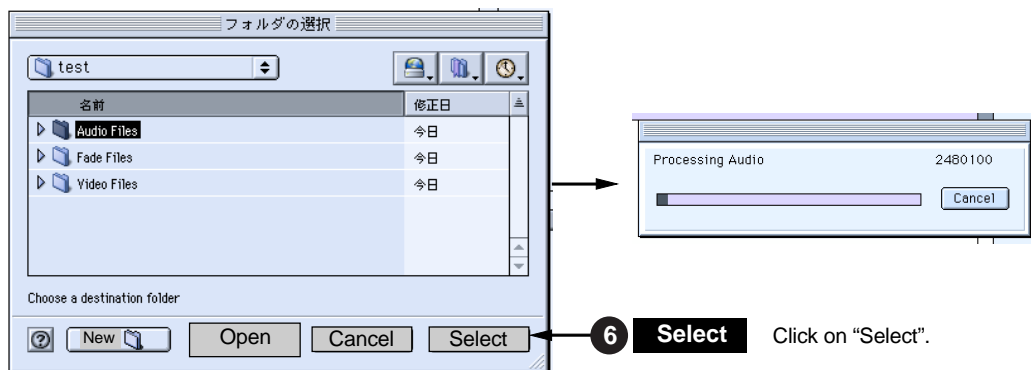

The saved file is added to the audio region list (indicated by an arrow 7).

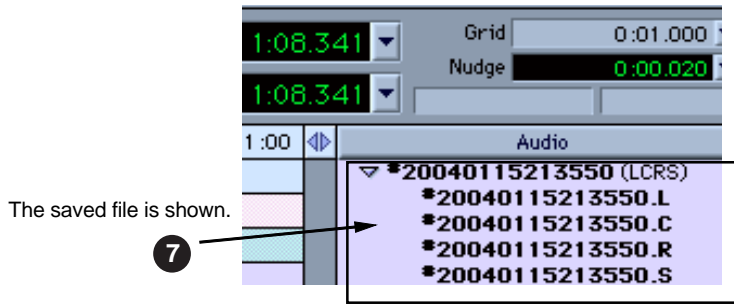

- 8) After making “Spot” active, drag and drop the audio region list to the track area (indicated by an arrow 8). The “Spot Dialog” setting window appears.

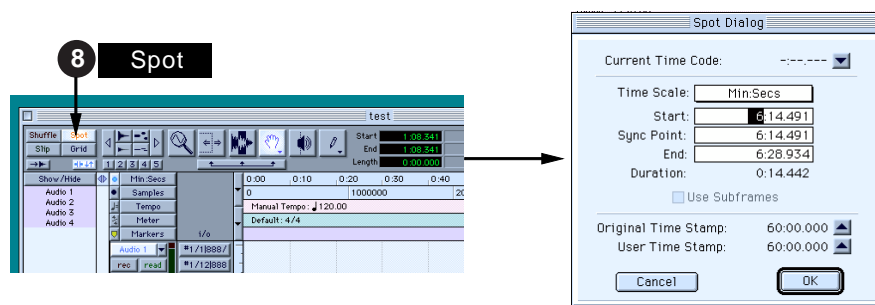

- 9) Click on “UP” in the “Spot Dialog” setting window, followed by “OK” (indicated by an arrow 9). By clicking on “UP”, the “original time stamp” time currently shown is set to the “Start” time. Then clicking on “OK” starts importing audio data from the specified position.

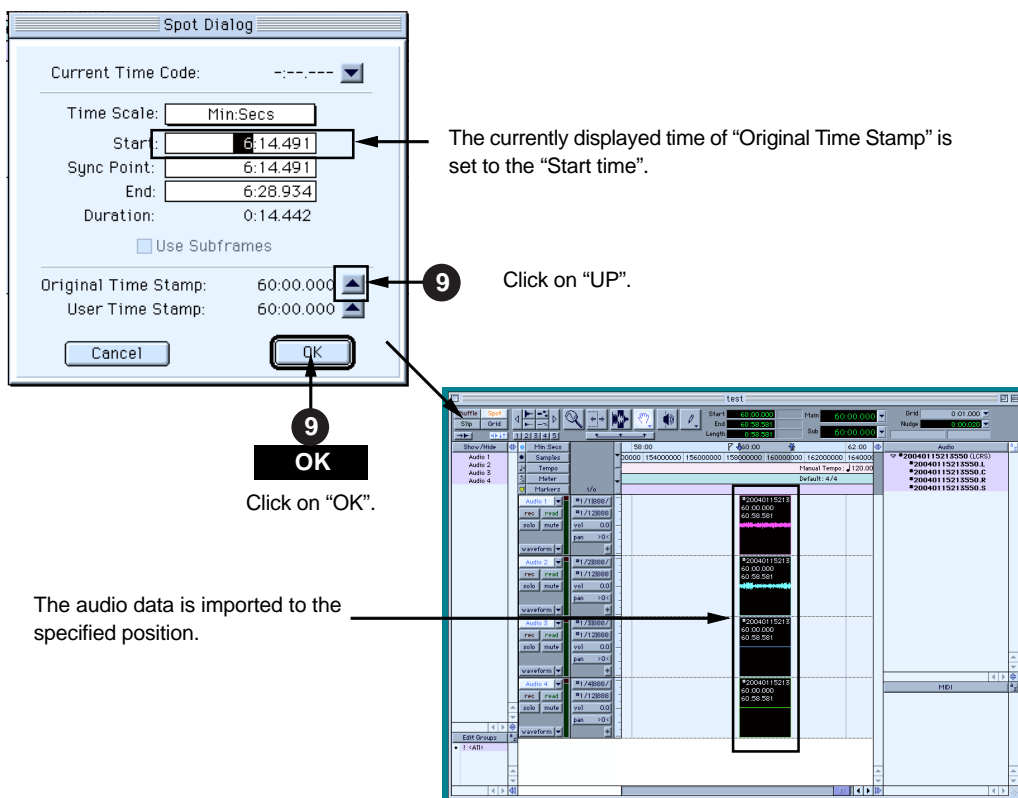

Chapter 7: Creating and editing ALE files (EDIT EDL FILE menu)

This chapter describes details about how to create an ALE (Avid Log Exchange) file for exporting audio data of the PD204 to an AVID system, as well as how to edit an existing ALE file.

Chapter 7 - Table of contents

Creating a new ALE file	122
Adding audio file entries to an ALE file	125
Viewing and editing audio file entries	127
Viewing audio file entries	127
Adding an audio file entry to an existing ALE file	128
Deleting an audio file entry	128
Editing an ALE file	129
Editing an ALE file name	129
Remaking an ALE file	130
Deleting an ALE file	131

On a DVD-RAM disk (or hard disk partition), the PD204 creates the "info" folder under the "bwff" folder. The "Info" folder stores ALE (Avid Log Exchange) files and various information files such as a diagnoses file.

About an ALE file

An ALE file is an EDL (Edit Decision List) file for exporting audio data created by the PD204 to an AVID system. Because it is a text file, a personal computer easily reads it. Note that the start and end time values of the file are referenced to the BWF time reference and data length. The ALE file is also used for the PD204 list play function.

The diagram illustrates the file structure on a DVD-RAM disk or partition. At the top level, there is a 'DVD RAM disk or Partition' represented by a cylinder. Below it, a vertical line represents the root directory. From this root, several items are listed: 'Resume.rsm', a folder named 'BWFF', and another folder named 'INFO'. The 'BWFF' folder contains three audio files, each named '****.wav'. The 'INFO' folder contains two ALE files, each named '****.ale'.

Creating a new ALE file

You can create a new ALE file on a recorded DVD-RAM disk or hard disk partition. In the procedure described below, we assume that more than one audio file (BWF) is created on the DVD-RAM disk (or hard disk partition) set to the PD204.

- 1) While the unit is stopped, press the [SHIFT] key to light the [SHIFT] indicator, followed by the [ENTER/YES] key.

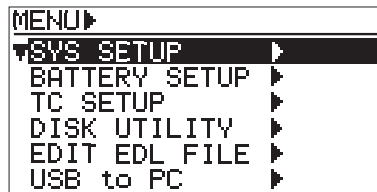

- 2) Use the [MENU] dial to select the "EDIT EDL FILE" menu and press the ENTER/YES] key. The unit enters the "EDIT EDL FILE" menu and the display now shows the ALE screen for selecting an ALE file.

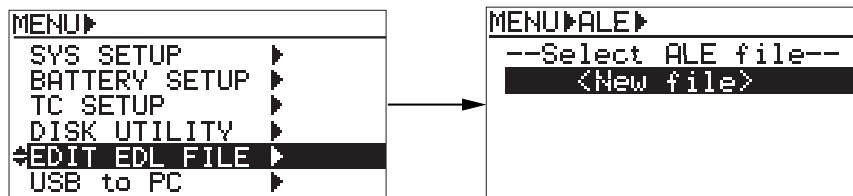

<Note>: If no ALE file exists on the disk (or partition), only "<New file>" is shown as the screen example above. If any ALE file exists on a disk, its current file name is shown.

- 3) While "<New file>" is highlighted, press the [ENTER/YES] key.
The display now shows the screen for entering a name of a newly created ALE file.

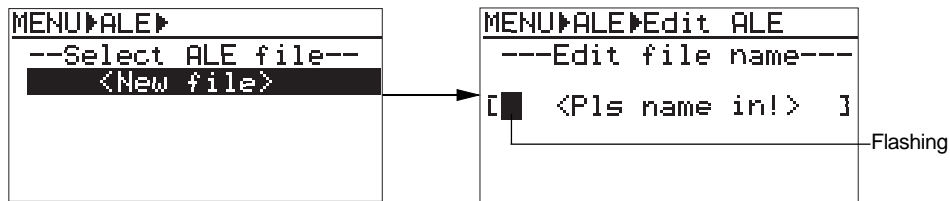

<Note>: The display shows the screen for entering a file name when creating a new ALE file, however, it shows the screen on which "Remake ALE" is highlighted if you select an existing ALE file for editing.

- 4) Use the [MENU] dial (or the alphanumeric keys) to enter the desired name.
In the screen example below, "ALL-TAKE" is entered as an ALE file name.



- 5) After entering the desired name, press the [ENTER/YES] key to confirm your setting.
The entered name is stored, while the display changes to show the screen for editing the ALE file, on which the "Video format" menu item is highlighted.

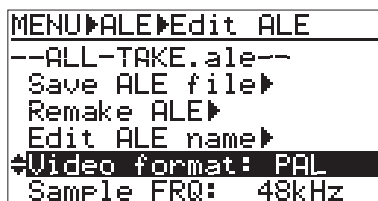

You can select a desired menu item by rotating the [MENU] dial. Typically, when you create a new ALE file, you make settings of menu items in the following order.
"Video format" -> "Sample FRQ" -> "TAPE" -> "TC frame" -> "Drop frame"
With each menu item, you can make editing/setting as below.

Menu	Function
Delete ALE file	Deletes an ALE file.
Save ALE file	Saves an ALE file.
Remake ALE	Remakes an ALE file.
Edit ALE name	Edits the name of an ALE file.
Video format	Sets the video format of an ALE file.
Sample FRQ	Sets the sampling frequency of an ALE file.
TAPE	Sets the reel number (TAPE) of an ALE file.
TC frame	Sets the TC Frame Rate of an ALE file.
Drop frame	Selects "On" or "Off" of the TC drop frame. You need to set it to "On" when you select "29.97" for the TC frame.
Entry files	Adds/deletes an audio file to/from the ALE file.

- 6) While "Video format" is highlighted, press the [ENTER/YES] key.
 The display changes to show the screen on which you can select the video format.
 The current option flashes (the default is "PAL").

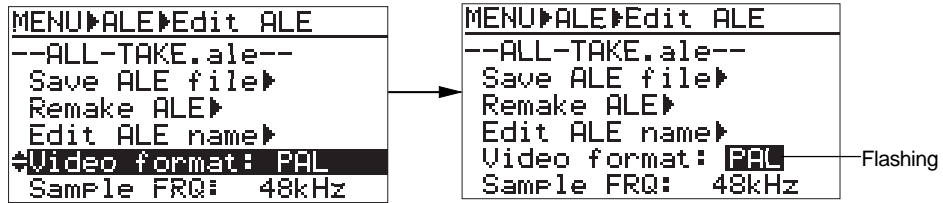

- 7) Use the [MENU] dial to select the video format, and press the [ENTER/YES] key to confirm your setting.

You can select the video format from among "PAL", "NTSC" and "SECAM".
 In the same manner as above, set the other menu items in the following order.
 "Sample FREQ" -> "TAPE" -> "TC frame" -> "Drop frame"
 The following table shows the options for each menu item setting.

Menu item	Options
Sample FREQ	You can select from among 44.1kHz, 48kHz, 88kHz, 96kHz, 176.4kHz and 192kHz.
TAPE	You can enter up to eight desired characters for a reel number (TAPE).
TC frame	You can select from among 23.97, 30, 24, 29.97 and 25.
Drop frame	You can select between On and Off (the default is "Off").

The initial setting for each menu item except the "Drop frame" menu item reflects the setting of the audio file loaded before the unit enters the EDIT EDL FILE menu.

<Notes>

- If you set the "TC frame" menu to "29.97", set the "Drop frame" menu to "On".
- You can use the [MENU] dial (or the alphanumeric keys) to enter "TAPE" (reel number). Use the [◀◀] or [▶▶] key to move the cursor.
 When using the alphanumeric keys for entering characters, pressing any other numeric key moves the cursor to the right automatically.

- 8) After making necessary settings, press the [EXIT] key.
 The display now shows the confirmation screen for making a new ALE file, on which "Are you sure?" flashes.

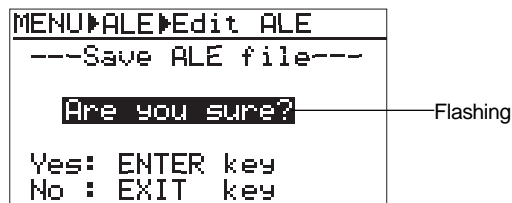

<Note>: To cancel creating a file list, press the [EXIT] key now.

- 9) Press the [ENTER/YES] key.
 A new ALE file is created and added to the ALE file list.
 ".ale", the file extension, is automatically added to the file name when an ALE file is created.

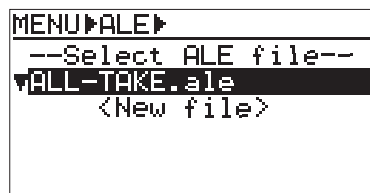

To create another new ALE file, select "<New file>" and follow the same procedure as above. If you want to exit the EDIT EDL FILE menu, press the [EXIT] key to dismiss the "Edit ALE" screen. In the following description, we continue editing operation and add audio file entries.

Adding audio file entries to an ALE file

You can add audio file entries to an ALE file.

The following shows how to add desired audio file entries to the ALE file named "ALL-TAKE.ale", created by the procedure described above.

<Notes>

- Only audio file entries whose FS match the FS set for the ALE file can be added.
- When playing back audio file entries in the DV824 list play mode, the condition follows the DV824 settings for the list play function, regardless of the ALE file settings.

- 1) While "ALL-TAKE.ale" is highlighted, press the [ENTER/YES] key.

The display now shows the screen for editing the ALE file, on which "Remake ALE" is highlighted.

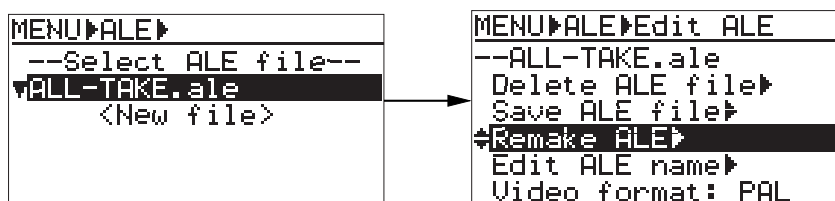

- 2) Use the [MENU] dial to select the "Entry files" menu item at bottom of the menu, and press the [ENTER/YES] key.

The display now shows the screen for audio file entry, on which "<New entry>" is highlighted.

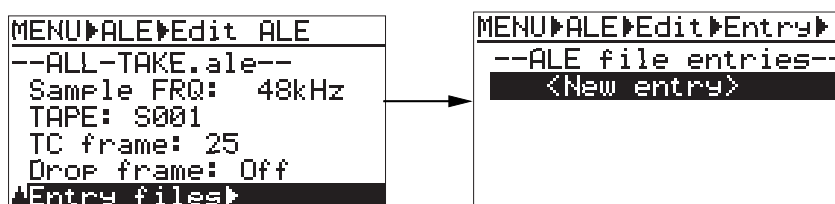

- 3) While "<New entry>" is highlighted, press the [ENTER/YES] key.

After showing "Please wait!", the display changes to show the screen for selecting audio files.

If you select "<Entry all>", all audio files on the current disk which can be added to the ALE file are added. You can also select from individual files shown below "<Entry all>".



<Note>: We recommend setting an audio file you want to add to an ALE file later as "Circle Take". When the file is set as "Circle Take", "@" is added to the beginning of the file name so that you can distinguish the file easier (see below for details).

<How to set a file as "Circle Take">

To set a file as "Circle Take", press the [CIRCLE TAKE] key while a desired audio file is loaded. When the file is set as "Circle Take", "@" is added to the beginning of the file name. Pressing the [CIRCLE TAKE] key again removes "@".

"@" is not shown on the Home screen, however, you can see it on the file select screen. To bring up the file select screen, press the [FILE SEL] key. In the following screen example, "@" is added to the "Scene_003.wav" file which is currently loaded.

Setting "Circle Take"

@

FILE SEL

[FNO]	[FILE NAME]
001	Scene_001.wav
002	Scene_002.wav
003	@Scene_003.wav
004	Scene_004.wav
005	Scene_005.wav

<File select screen>

- 4) **Select "<Entry all>" or any desired audio file, and press the [ENTER/YES] key.**
 If you select "<Entry all>" and press the [ENTER/YES] key, all audio file entries are shown on the screen (you can scroll through the list by rotating the [MENU] dial).



If you select an individual audio file and press the [ENTER/YES] key, "Sel. next entry!" is shown and you can make another selection successively. Note that the audio file entries added to the ALE file are omitted from the audio entry selection list. After adding all desired files to the ALE file, press the [EXIT] key. The display now shows the screen as below, on which you can check the entries. In the screen example below, audio file "001" is added.

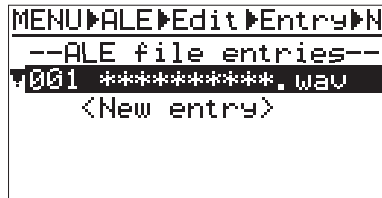

- 5) **After adding audio file entries, press the [EXIT] key.**
 The display returns to the screen for selecting an item for editing the ALE file.
- 6) **Press the [EXIT] key again (or use the [MENU] dial to select "Save ALE file" and press the [ENTER/YES] key).**
 The display shows the screen for saving the ALE file, on which "Are you sure?" flashes.
- 7) **Press the [ENTER/YES] key to save the ALE file.**
- 8) **Press the [EXIT] key to exit the EDIT EDL FILE menu.**

Viewing and editing audio file entries

You can view audio file entries in an ALE file, as well as add (or delete) an audio file entry to (or from) the ALE file.

Viewing audio file entries

We assume that you have created an ALE file named "ALL-TAKE.ale", as described in the previous procedure.

- 1) While the unit is stopped, press the [SHIFT] key to light the [SHIFT] indicator, followed by the [ENTER/YES] key.

```
MENU▶
▼SYS SETUP ▶
BATTERY SETUP ▶
TC SETUP ▶
DISK UTILITY ▶
EDIT EDL FILE ▶
USB to PC ▶
```

- 2) Using the [MENU] dial to select the "EDIT EDL FILE" menu and press the [ENTER/YES] key. The unit enters the "EDIT EDL FILE" menu and the display now shows the ALE screen for selecting an ALE file. You can see "ALL-TAKE.ale" and "<New file>" in the "Select ALE file" list.

```
MENU▶
SYS SETUP ▶
BATTERY SETUP ▶
TC SETUP ▶
DISK UTILITY ▶
▼EDIT EDL FILE ▶
USB to PC ▶
```

```
MENU▶ALE▶
--Select ALE file--
▼ALL-TAKE.ale
<New file>
```

- 3) While "ALL-TAKE.ale" is highlighted, press the [ENTER/YES] key. After showing "Please wait!", the display shows the screen for editing an ALE file (on which "Remake ALE" is highlighted).

```
MENU▶ALE▶
--Select ALE file--
▼ALL-TAKE.ale
<New file>
```

```
MENU▶ALE▶Edit ALE
--ALL-TAKE.ale
Delete ALE file▶
Save ALE file▶
▼Remake ALE▶
Edit ALE name▶
Video format: PAL
```

- 4) Use the [MENU] dial to select "Entry files", and press the [ENTER/YES] key. The screen now shows the entry list in which you can scroll through audio file entries by rotating the [MENU] dial.

```
MENU▶ALE▶Edit ALE
--ALL-TAKE.ale--
Sample FRQ: 48kHz
TAPE: S001
TC frame: 25
Drop frame: Off
▼Entry files▶
```

```
MENU▶ALE▶Edit▶Entry▶
--ALE file entries--
▼001 ***** .wav
002 ***** .wav
003 ***** .wav
004 ***** .wav
005 ***** .wav
```

While the file entry list above is shown, you can add a new audio file to the list or delete an unnecessary audio file from the list. See the next page for details.

If you want to exit the EDIT EDL FILE menu after viewing the list, press the [EXIT] key repeatedly until exiting the EDIT EDL FILE menu.

Adding an audio file entry to an existing ALE file

- 1) **On the entry list screen shown in step 3 of "Viewing audio file entries" in the previous page, use the [MENU] dial to select "<New entry>" and press the [ENTER/YES] key.**
The display now shows the list, in which available audio files except those already added to the ALE file, as well as "<Entry all>", are listed.
- 2) **Select "<Entry all>" or any desired audio file, and press the [ENTER/YES] key.**
The selected audio file is added to the ALE file (if you select "<Entry all>", all available files are added).
- 3) **After adding all desired audio file to the ALE file, press the [EXIT] key.**
The display returns to show the entry list screen.
- 4) **Press the [EXIT] key twice.**
The display shows the screen for resaving the edited ALE file, on which "Are you sure?" flashes.
- 5) **Press the [ENTER/YES] key to resave the ALE file.**

To exit the EDIT EDL FILE menu, press the [EXIT] key repeatedly.

Deleting an audio file entry

- 1) **On the entry list screen, use the [MENU] dial to select the file entry you want to delete and press the [CLEAR] key.**
After showing "Deleted!", the selected file entry is deleted immediately.

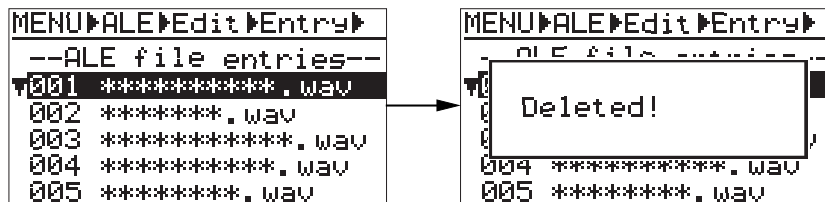

- 2) **Press the [EXIT] key twice.**
The display shows the screen for resaving the edited ALE file, on which "Are you sure?" flashes.
- 3) **Press the [ENTER/YES] key to resave the ALE file.**

To exit the EDIT EDL FILE menu, press the [EXIT] key repeatedly.

Editing an ALE file

You can edit an existing ALE file. The editing functions include:

- Editing an ALE file name and resave it.
- Remaking an ALE file after its audio file entry is edited.
- Deleting an unnecessary ALE file.

Editing an ALE file name

You can edit an existing ALE file name and resave the edited name.

The following example shows how to edit the "ALL-TAKE.ale" ALE file created in the operation example described earlier.

- 1) While the unit is stopped, press the [SHIFT] key to light the [SHIFT] indicator, followed by the [ENTER/YES] key.

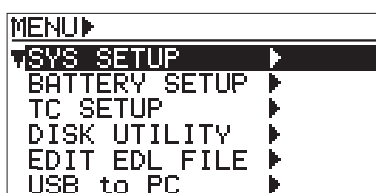

- 2) Use the [MENU] dial to select the "EDIT EDL FILE" menu and press the [ENTER/YES] key. The display now shows the ALE list for selecting a desired ALE file from among the existing ALE files (in the ALE list example below, "ALL-TAKE.ale" is shown).

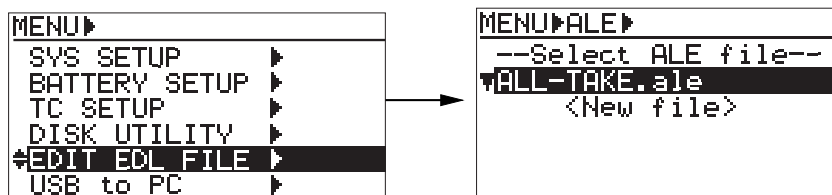

- 3) While "ALL-TAKE.ale" is highlighted, press the [ENTER/YES] key. After showing "Please wait!", the display changes to show the screen for ALE file editing.
- 4) Use the [MENU] dial to select "Edit ALE name" and press the [ENTER/YES] key. The display now shows the screen for file name editing, on which the leftmost character of the current name flashes.

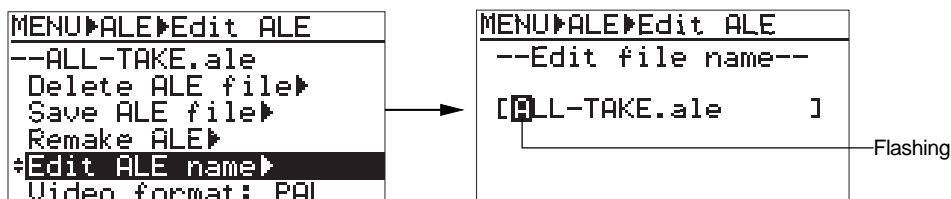

Use the [◀◀]/[▶▶] keys to move the cursor position and use the [MENU] dial (or the alphanumeric keys) to enter a desired character. By pressing the [CLEAR] key repeatedly when the cursor is pointing the leftmost character, you can clear the whole name. The file extension (".ale") is automatically added to the name so you do not need to enter it.

- 5) After completing editing the name, press the [ENTER/YES] key. The new name is confirmed and the display returns to the screen on which you can select an editing item.
- 6) Press the [EXIT] key repeatedly until you exit the EDIT EDL FILE menu.

Remaking an ALE file

If you edit the start time, end time, or the description information of an audio file which is listed in the ALE file, the ALE file must be remade. You can also remake the ALE file which contains only audio files whose "Circle take" is set to "On".

The following procedure describes how to remake the ALE file named "ALL-TAKE.ale", assuming that any of audio files listed in the ALE file has been edited after it was added to the ALE file.

- 1) While the unit is stopped, press the [SHIFT] key to light the [SHIFT] indicator, followed by the [ENTER/YES] key.

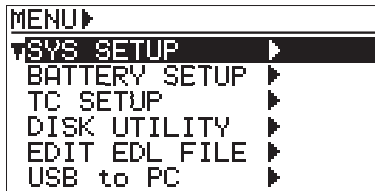

- 2) Use the [MENU] dial to select the "EDIT EDL FILE" menu and press the [ENTER/YES] key. The unit enters the "EDIT EDL FILE" menu and the display now shows the ALE screen for selecting an ALE file. On the example screen below, "ALL-TAKE.ale" is shown.

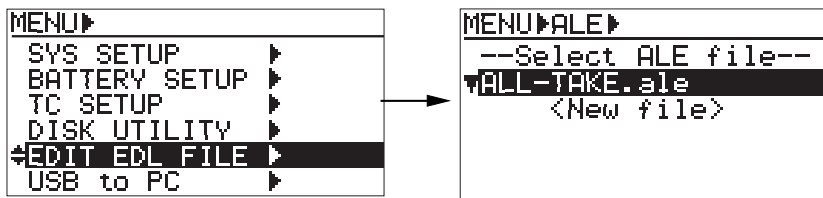

- 3) While "ALL-TAKE.ale" is highlighted, press the [ENTER/YES] key. After showing "Please wait!", the display shows the screen for editing an ALE file (on which "Remake ALE" is highlighted).

- 4) While "Remake ALE" is highlighted, press the [ENTER/YES] key. The display now shows the screen for selecting the remaking "Type" (by default, "Renewal" flashes). You can select the "Type" option between "Renewal" and "Circle Take".

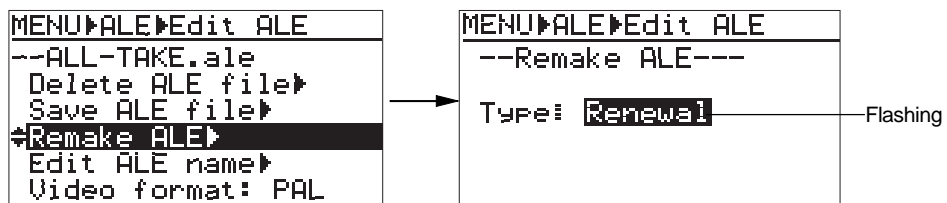

Renewal	Circle Take
The audio file entry list in the ALE file is not changed. The ALE file is updated by remaking only the edited items (such as the start time, end time, etc.) in audio files.	A new ALE file, containing only audio file entries whose "Circle take" is set to "On", is created. The old (previous) ALE file is deleted.

- 5) Select the desired type and press the [ENTER/YES] key. If you select "Renewal", the PD204 immediately remakes the ALE file, and the display returns to show the screen on which you can select an editing item. If you select "Circle Take", "Sure?" flashes on the screen. Press the [ENTER/YES] key again. The PD204 remakes the ALE file, and the display returns to show the screen on which you can select an editing item.

<Note>: As described above, executing "Circle Take" erases the old list. If you cancel executing "Circle Take" in step 4) above, press the [EXIT] key.

- 6) **After "Remake ALE" completes, press the [EXIT] key.**
The display shows the screen for updating the remade ALE file, on which "Are you sure?" flashes.
- 7) **Press the [ENTER/YES] key.**
The remade ALE file is updated and the display returns to show the screen on which you can select an editing item.
- 8) **Press the [EXIT] key repeatedly until you exit the EDIT EDL FILE menu.**

Deleting an ALE file

You can delete an ALE file.

The following procedure example describes how to delete the "ALL-TAKE.ale" file.

- 1) **While the unit is stopped, press the [SHIFT] key to light the [SHIFT] indicator, followed by the [ENTER/YES] key.**

```

MENU▶
▼SYS SETUP ▶
  BATTERY SETUP ▶
  TC SETUP ▶
  DISK UTILITY ▶
  EDIT EDL FILE ▶
  USB to PC ▶
  
```

- 2) **Use the [MENU] dial to select the "EDIT EDL FILE" menu and press the [ENTER/YES] key.**
The unit enters the "EDIT EDL FILE" menu and the display now shows the ALE screen for selecting an ALE file. On the example screen below, "ALL-TAKE.ale" is shown.

```

MENU▶
  SYS SETUP ▶
  BATTERY SETUP ▶
  TC SETUP ▶
  DISK UTILITY ▶
  ◀EDIT EDL FILE ▶
  USB to PC ▶
  
```

→

```

MENU▶ALE▶
--Select ALE file--
▼ALL-TAKE.ale
  <New file>
  
```

- 3) **While "ALL-TAKE.ale" is highlighted, press the [ENTER/YES] key.**
After showing "Please wait!", the display shows the screen for editing an ALE file (on which "Remake ALE" is highlighted).
- 4) **Use the [MENU] dial to select the "Delete ALE file", and press the [ENTER/YES] key.**
The display now shows the screen for deleting the selected ALE file, on which "Are you sure?" flashes.

```

MENU▶ALE▶Edit ALE
--ALL-TAKE.ale--
▼Delete ALE file▶
  Save ALE file▶
  Remake ALE▶
  Edit ALE name▶
  Video Format:NTSC
  
```

→

```

MENU▶ALE▶Edit ALE
---Delete file---
  ALL-TAKE.ale
  Are you sure?
  Yes:ENTER key
  No :Exit key
  
```

Flashing

- 5) **Press the [ENTER/YES] key to delete the file.**
The ALE file is deleted and the display returns to show the screen for selecting an ALE file.
- 6) **Press the [EXIT] key repeatedly until you exit the EDIT EDL FILE menu.**

Chapter 8: MENU mode

Chapter 8 - Table of contents

About MENU mode	134
SYS SETUP menu	136
Project name setting	137
Default file name setting	138
Default track name setting	140
Next event number setting	141
Recording FS/bit length setting	142
Pull up/down setting	143
Digital output setting	144
Diagnoses file setting	145
Peak hold time setting	146
Slate tone/pop tone recording mode setting	147
Pause cancel time setting	149
USB keyboard type setting	150
Pre rec time setting	151
Maximum file length setting	152
Continuous recording function	153
False start mode setting	155
Limiter parameter setting	156
ANALOG OUT nominal level setting	158
Monitor speaker mute setting	159
Error tone output setting	160
Chain play mode setting	163
ROM version checking	164
BATTERY SETUP menu	165
Battery low voltage warning setting	166
DC-IN low voltage warning setting	167
Power supply priority setting	168
Battery priority setting	169
Battery remaining time	172
Battery status	173
TC SETUP menu	174
System clock selection	175
TC frame rate selection	176
Generator mode selection	177
Internal TC generator setting	178
User bit setting	180
Jam mode setting	182
Time code output source setting	183
Default LTC start time setting	184
LTC start time editing	185
UBIT setting of playback time code	186
Time code output while paused	187
Automatic recording start by external TC	188
Internal TC generator power-off timer	189
DISK UTILITY menu	190
Editing a file name	191
Viewing a file information and editing descriptor information	192
Deleting an unnecessary audio file	196
Restoring a deleted audio file	197
Formatting a disk (or a hard disk partition)	198
Editing the reel number (Volume label)	202
Record protection On/Off setting	203
Resume function On/Off setting	204
Partition protection On/Off setting	205
HDD operating time display	206
LOAD SETUP menu	207
SAVE SETUP menu	208

About MENU mode

In the MENU mode, various essential setting and execution menu items are available. While the unit is stopped, you can enter the MENU mode by pressing the [SHIFT] key to enter shift mode followed by the [ENTER/YES] key. The display shows the MENU list screen as shown below. You can select a desired menu using the [MENU] dial. For the brief introduction of each main menu, see the next page.

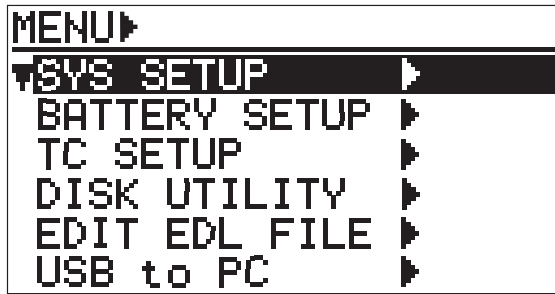
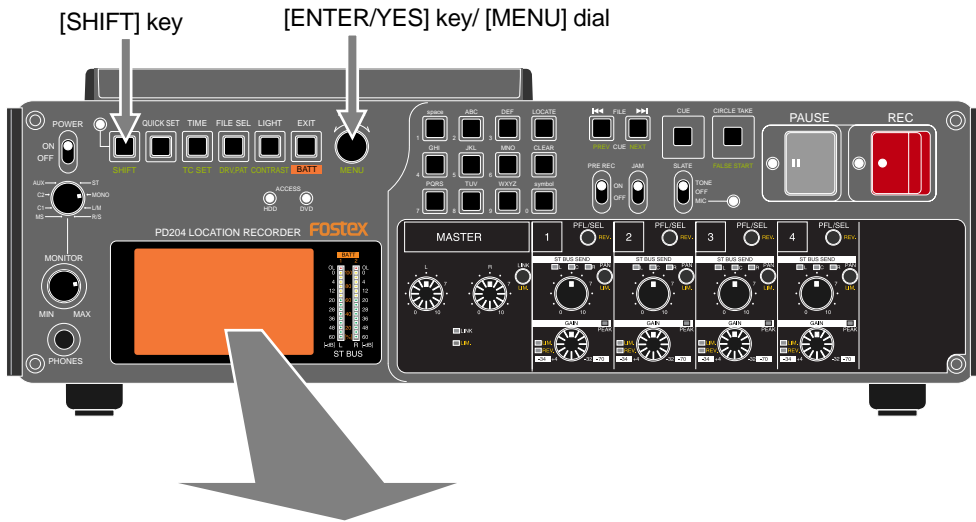

<MENU list screen>

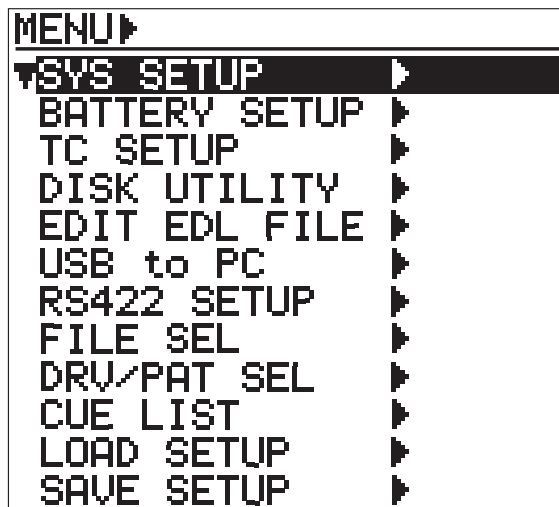

<Whole MENU list>

The following shows the brief introduction of each menu.
This chapter describes details of the menus with "*" in the following table. For the details of the menus without "*", see the associated pages indicated below.

Menu name (in the displayed order)	Contents
* SYS SETUP menu	This menu includes menu items for setting preferences. 24 menu items are available.
* BATTERY SETUP menu	This menu includes menu items for settings when the unit is operated on battery. Seven menu items are available.
* TC SETUP menu	This menu includes menu items regarding time code recording/playback, synchronization to an external device, etc. Thirteen menu items are available.
* DISK UTILITY menu	This menu includes menu items for settings regarding a DVD-RAM disk and hard disk drive partition, as well as disk formatting. Twelve menu items are available.
EDIT EDL FILE menu	This menu allows you to create and edit an ALE file (see page 121 for details).
USB to PC menu	This menu is used when connecting or disconnecting between the PD204 and personal computer (see page 116 for details).
RS422 SETUP menu	This menu is not supported. It is prepared for future expansion.
FILE SEL menu	This menu allows you to select an audio file. You can directly enter this menu simply by pressing the [FILE SEL] key (see page 96 for details).
DRV/PAT SEL menu	This menu allows you to select a drive/partition. You can directly enter this menu by pressing the [SHIFT] key followed by the [FILE SEL] key (see page 84 for details).
CUE LIST menu	This menu allows you to view and edit the cue list. You can directly enter this menu simply by pressing the [CUE] key (see page 93 for details).
* LOAD SETUP menu	This menu allows you to load the settings saved by using the SAVE SETUP menu.
* SAVE SETUP menu	This menu allows you to save the all settings in the MENU mode.

SYS SETUP menu

In the SYS SETUP menu, the following menu items for settings regarding recording/playback are available. You can save setting data using the "SAVE SETUP" menu and recall the saved data whenever you want (see pages 207 and 208).

<Note>: For the "Auto copy" and "Adjust RTC" menu items in the SYS SETUP menu, see pages shown below.

Menu item	Contents
Set project name	Edits a project name recorded to an iXML file.
Default file name	Edits the default file name of an audio file created when recording.
Default TrkName	Edits the default track name of a BWF file created when recording.
Next event No	Sets the event number in the description information of an audio file.
Record FS & Bit	Selects the Fs and bit length of the audio file created when recording.
Pull up/down	Selects pull up/down setting when using the internal clock reference.
Auto copy	Selects the auto copy mode which enables simultaneous recording to a DVD-RAM disk when making recording to a hard disk partition (see page 104).
Digital out	Selects the digital output audio format.
Diagnoses	Selects whether or not creating a diagnoses file which logs errors during recording, etc.
Peak hold	Sets the peak hold time of the bargraph meters.
Tone rec mode	Sets the recording time and mode of the slate tone.
Pause time	Sets the pause cancel time.
Keyboard Sel	Selects the type of a USB keyboard connected to the [USB KYBD] connector.
Pre rec time	Sets the pre recording time of audio pooled in the buffer.
Max file length	Sets the maximum recording volume of a file.
Auto part. link	Sets on/off of the auto partition link function.
False start	Selects the false start mode.
Limiter parameter	Sets the limiter parameters.
Stereo out level	Selects the output reference level of the [ANALOG OUT] connectors.
Speaker mute	Selects on/off of muting the internal speaker when the unit is not in playback mode.
Error tone	Selects whether or not the unit outputs the warning tone for four types of conditions.
Chain play	Selects how the recorder behaves after it finishes playback of an audio file.
Adjust RTC	Adjusts the internal realtime clock (see page 31).
Version	Shows the system version of the unit.

Project name setting [Set project name]

The "Set project name" menu item sets the project name recorded to an iXML file.

- 1) While the unit is stopped, press the [SHIFT] key to light the SHIFT indicator, followed by the [ENTER/YES] key.
- 2) While "SYS SETUP" is highlighted, press the [ENTER/YES] key.
The display now shows the SYS SETUP menu screen.

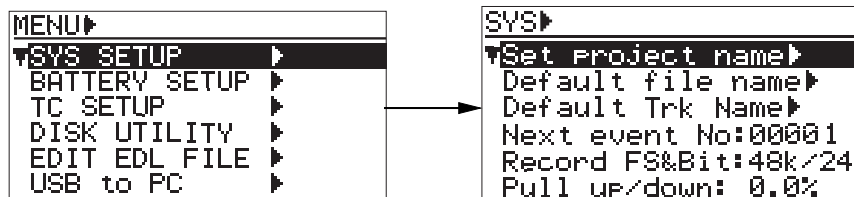

- 3) Use the [MENU] dial to select the "Set project name" menu item and press the [ENTER/YES] key.
The display now shows the screen for entering a project name.

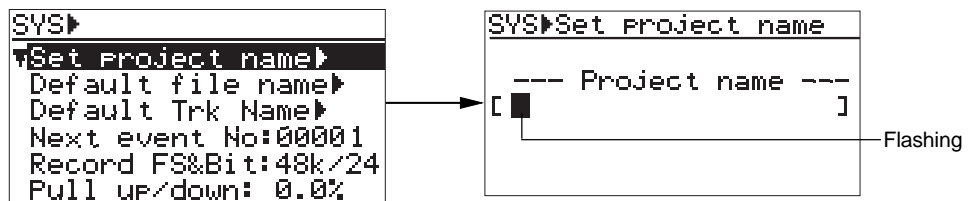

- 4) Use the [MENU] dial or alphanumeric keys entering the desired project name, press the [ENTER/YES] key to confirm your setting.
Use the [◀◀]/[▶▶] keys to move the cursor position. By pressing the [CLEAR] key when the cursor is pointing any character of the name, you can clear the whole name.
The project name is stored to the Flash ROM of the unit, while recorded to an iXML file.

Characters you can enter using the [MENU] dial

Alphabetical characters: A ~ Z, a ~ z

Numerical characters: 0 ~ 9

Symbols: !, #, \$, %, &, ', (,), +, -, ., /, =, @, [,], ^, _, -, >, <, space

Characters you can enter using the alphanumeric keys

Alphabetical characters: A ~ Z, a ~ z

Numerical characters: 0 ~ 9

Symbols: !, #, \$, %, &, ', (,), +, -, ., /, =, @, [,], ^, _, -, >, <, space

- 5) Press the [EXIT] key repeatedly until you exit the MENU mode.

Default file name setting [Default file name]

The "Default file name" menu item selects the default name format of an audio file which is created automatically when recording starts.

You can give a file name of date information (according to the internal realtime clock), a scene name with a take number, or a reel number with a file number.

- 1) While the unit is stopped, press the [SHIFT] key to light the SHIFT indicator, followed by the [ENTER/YES] key.
- 2) While "SYS SETUP" is highlighted, press the [ENTER/YES] key.
The display now shows the SYS SETUP menu screen.

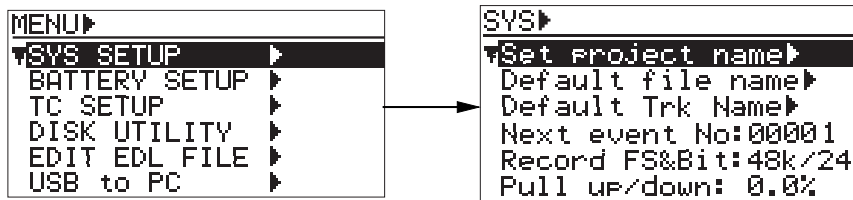

- 3) Use the [MENU] dial to select the "Default file name" menu item and press the [ENTER/YES] key.

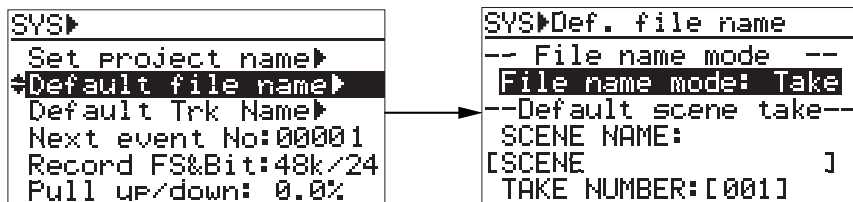

- 4) Press the [ENTER/YES] key.
The currently selected mode starts flashing (the default mode is "Take").

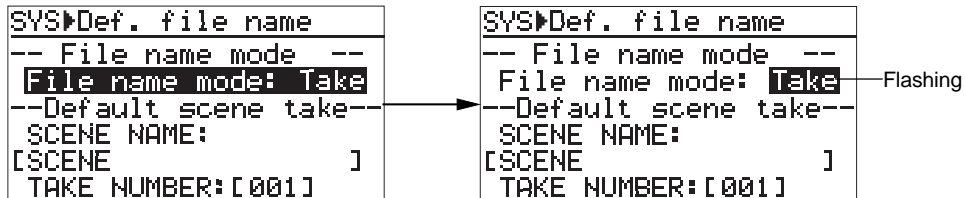

- 5) Use the [MENU] dial to select the desired option and press the [ENTER/YES] key.
When setting the file name mode to "Take", the SCENE NAME and TAKE NUMBER specified on the same screen are used for each file name.
Even if you set the file name to "Date" or "Reel", the SCENE NAME and TAKE NUMBER currently set are used as the SCENE data in the meta data.

Options	
You can select from among "Date", "Take" and "Reel" (the default is "Take").	
Date	The internal realtime clock data is the file name. Example: B05h 05m 06s 10oct 2007.wav (" <DATE> .wav" is shown in the "Next file name" field on the Home screen.)
Take	" <SCENE NAME> + <TAKE NUMBER> " (with ".wav", the file extension) is the file name. The take number is incremented automatically each time recording is made. Example: Scene-001.wav, Scene-002.wav,
Reel	The reel number of a drive (DVD drive or a partition of the internal HDD) currently selected for recording with the file number is the default file name. Example: S001_005.wav, S002_008.wav, etc.

- 6) Use the [MENU] dial to select “SCENE NAME”, and press the [ENTER/YES] key.

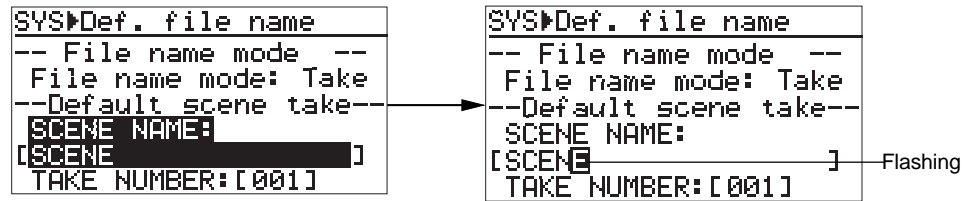

- 7) Use the [MENU] dial or alphanumeric keys entering the desired scene name, press the [ENTER/YES] key to confirm your setting.

Use the [←←]/[→→] keys to move the cursor position. By pressing the [CLEAR] key when the cursor is pointing any character of the name, you can clear the whole name.

Scene name
Up to 247 ASCII characters can be entered (note that only 55 characters are valid for BWF). “.wav”, the file extension, is automatically added, therefore, you do not need to enter it.

- 8) After entering the scene name, press the [ENTER/YES] key.

The scene name is confirmed and you can now set a take number.

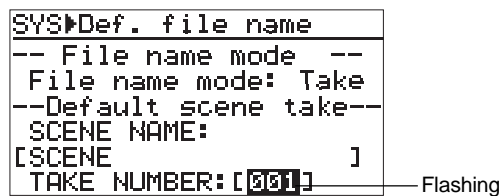

- 9) Use the [MENU] dial or alphanumeric keys to enter the desired take number, and press the [ENTER/YES] key to confirm your setting.

Take number
Any number between 001 and 999 can be entered.

<Note>: If you enter “000” to the TAKE NUMBER field, it is automatically set as “001”.

- 10) Press the [EXIT] key repeatedly until you exit the MENU mode.

Default track name setting [Default TrkName]

The “Default TrkName” menu item specifies the default track name for each track of a BWF file created when recording is made.

The track name specified is automatically added to the track number whenever an audio file is created. The data is recorded to each file as the “fTRKn” information of the BWF BEXT Chunk Description. The default track name is stored in the System ROM of the unit.

- 1) While the unit is stopped, press the [SHIFT] key to light the SHIFT indicator, followed by the [ENTER/YES] key.
- 2) While “SYS SETUP” is highlighted, press the [ENTER/YES] key.
The display now shows the SYS SETUP menu screen.

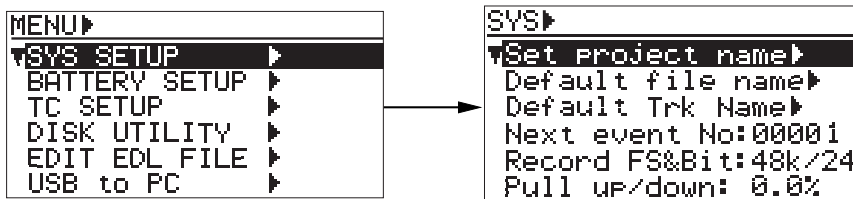

- 3) Use the [MENU] dial to select the “Default TrkName” menu item and press the [ENTER/YES] key.
The display now shows the current track name of each track.

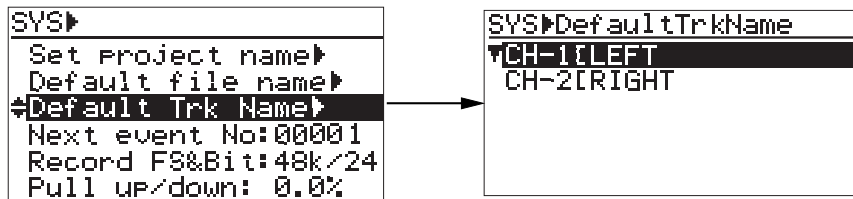

- 4) Use the [MENU] dial to select a track number and press the [ENTER/YES] key.
You are ready for entering the track name.

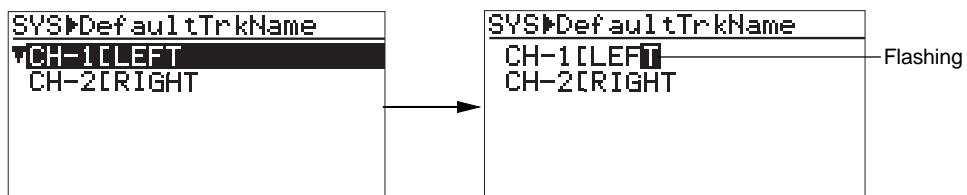

- 5) Use the [MENU] dial or alphanumeric keys to enter the desired track name, and press the [ENTER/YES] key to confirm your setting.
Use the [◀◀]/[▶▶] keys to move the cursor position. By pressing the [CLEAR] key when the cursor is pointing the character, you can clear the whole name.
- 6) Press the [EXIT] key repeatedly until you exit the MENU mode.

<Note>: You can change track names of a file later by using the “Edit descriptor” function of the “File Info.” menu item in the “DISK UTILITY” menu (see page 192).

Next event number setting [Next event No]

The “Next event No” menu item sets the event number in the description information of an audio file. The event number is recorded to each file as “fEVENT” information in the BWF BEXT Chunk Description. The setting is stored in the System ROM of the unit.

- 1) While the unit is stopped, press the [SHIFT] key to light the SHIFT indicator, followed by the [ENTER/YES] key.
- 2) While “SYS SETUP” is highlighted, press the [ENTER/YES] key.
The display now shows the SYS SETUP menu screen.

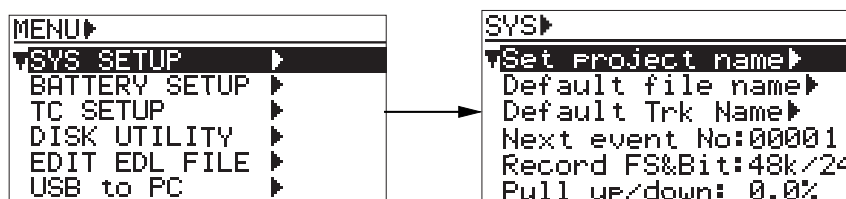

- 3) Use the [MENU] dial to select the “Next event No” menu item and press the [ENTER/YES] key.

The current setting starts flashing and you can now select the desired option.

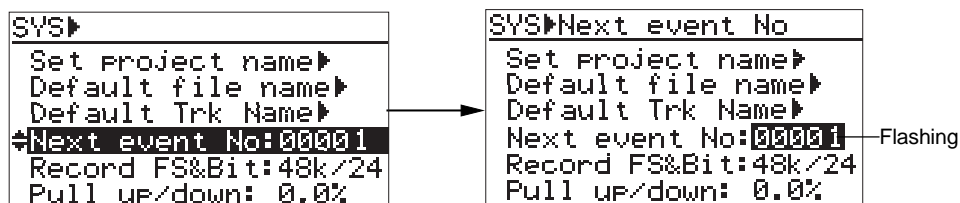

Options

You can set the “Next event No” to a desired number between “00001” and “99999”.

<Note>: The edited value is reflected to newly recorded audio file. It does not affect the current audio file. If the event number exceeds 99999, the number returns to 00000.

- 4) Use the [MENU] dial to enter the desired number and press the [ENTER/YES] key to confirm your setting.
- 5) Press the [EXIT] key repeatedly until you exit the MENU mode.

Recording FS/bit length setting [Record FS&Bit]

The “Record FS&Bit” menu item sets the recording sampling frequency and bit length. You can also make the setting via the quick setup mode on the Home screen. The setting is stored to the Flash ROM of the unit.

- 1) While the unit is stopped, press the [SHIFT] key to light the SHIFT indicator, followed by the [ENTER/YES] key.
- 2) While “SYS SETUP” is highlighted, press the [ENTER/YES] key.
The display now shows the SYS SETUP menu screen.

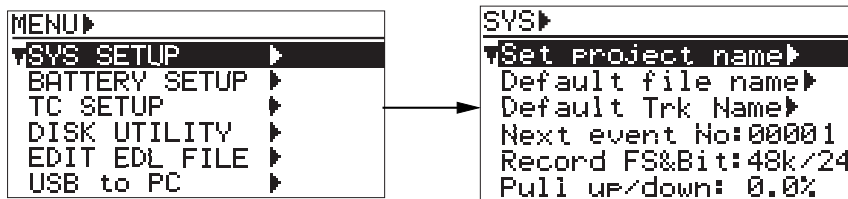

- 3) Use the [MENU] dial to select the “Record FS&Bit” menu item and press the [ENTER/YES] key.
The current setting starts flashing and you can now select the desired option.

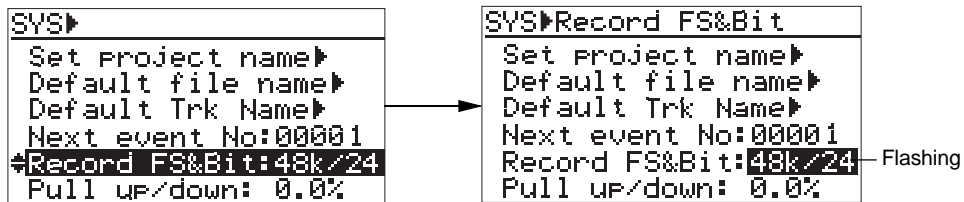

Options
You can select from among the following: 44/16, 48/16, 44/24, 48/24, 88/24, 96/24, 176/24, 192/24 (the default is “48/24”)

- 4) Use the [MENU] dial to select the desired option and press the [ENTER/YES] key to confirm your setting.
The current setting is shown in the status area on the Home screen.
- 5) Press the [EXIT] key repeatedly until you exit the MENU mode.

Pull up/down setting [Pull up/down]

The “Pull up/down” menu item makes clock pull up/down when the unit is referenced to the internal clock. You can also make the setting via the quick setup mode on the Home screen. The setting is stored to the Flash ROM of the unit.

- 1) While the unit is stopped, press the [SHIFT] key to light the SHIFT indicator, followed by the [ENTER/YES] key.
- 2) While “SYS SETUP” is highlighted, press the [ENTER/YES] key.
The display now shows the SYS SETUP menu screen.

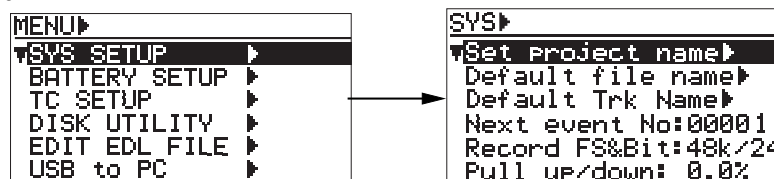

- 3) Use the [MENU] dial to select the “Pull up/down” menu item and press the [ENTER/YES] key.
The current setting starts flashing and you can now select the desired option.

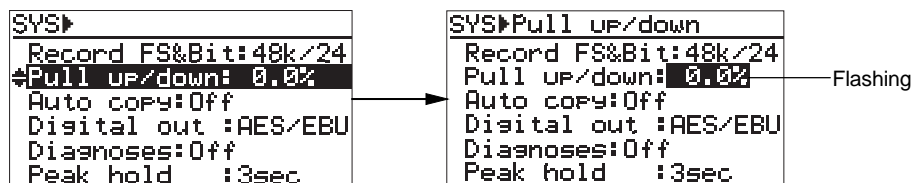

Options			
You can select from among “-0.1%”, “0.0%” and “+0.1%” (the default is “0.0%”).			
0.0%	+ 0.1%	- 0.1%	
23.97 FPS	24 FPS	23.97 FPS	The TC frame changes only when the clock is pulled up.
24 FPS	24 FPS	23.97 FPS	The TC frame changes only when the clock is pulled down.
25 FPS	Unselectable	Unselectable	
29.97 FPS	30 FPS	29.97 FPS	The TC frame changes only when the clock is pulled up.
30 FPS	30 FPS	29.976	The TC frame changes only when the clock is pulled down.

- 4) Use the [MENU] dial to select the desired option and press the [ENTER/YES] key to confirm your setting.
- 5) Press the [EXIT] key repeatedly until you exit the MENU mode.
The current setting is shown in the status area on the Home screen.

<Note>: As shown in the table above, you cannot make pull-up or pull-down setting when the TC frame is 25fps. If you set the “Pull up/down” menu item to “+0.1%” or “-0.1%” when the TC frame is 25fps, “+0.1%” or “-0.1%” is shown in the status information area on the Home screen.

<Note>: While pulled up or down, the PD204 can lock to an external clock (video, frame pulse or field pulse) with a frame rate shown in the table above (+/- 100PPM).

<Note>: When the system clock cannot lock to the external or internal clock, the popup window on the right appears on the display. In this case, the unit may malfunction. Consult your local Fostex service department.

---CAUTION---
SYSTEM UNLOCKED!

Digital output signal format selection [Digital out]

The “Digital out” menu item selects the format (AES/EBU or S/P DIF) of the digital signal which is output from the [DIGITAL OUT] connector.

- 1) While the unit is stopped, press the [SHIFT] key to light the SHIFT indicator, followed by the [ENTER/YES] key.
- 2) While “SYS SETUP” is highlighted, press the [ENTER/YES] key.
The display now shows the SYS SETUP menu screen.

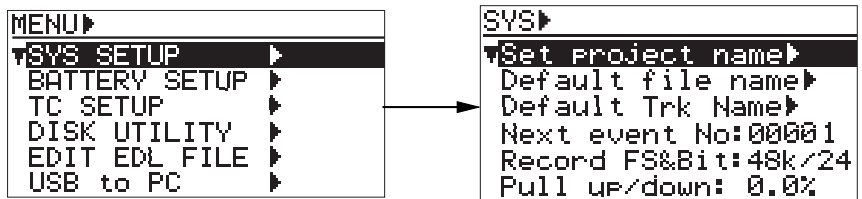

- 3) Use the [MENU] dial to select the “Digital out” menu item and press the [ENTER/YES] key.
The current setting starts flashing and you can now select the desired option.

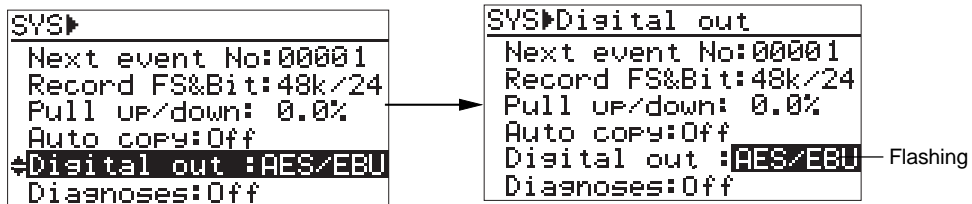

Options	
You can select from among “AES/EBU” and “S/P DIF” (the default is “AES/EBU”).	
AES/EBU	IEC 60958 Part3 (AES/EBU) format digital signal is output.
S/P DIF	IEC 60958 Part2 (S/P DIF) format digital signal is output.

- 4) Use the [MENU] dial to select the desired option and press the [ENTER/YES] key to confirm your setting.
- 5) Press the [EXIT] key repeatedly until you exit the MENU mode.

Diagnoses file setting [Diagnoses]

The “Diagnoses” menu item selects whether or not creating a diagnoses file which logs errors during recording, etc. The setting is stored to the Flash ROM of the unit.

- 1) While the unit is stopped, press the [SHIFT] key to light the SHIFT indicator, followed by the [ENTER/YES] key.
- 2) While “SYS SETUP” is highlighted, press the [ENTER/YES] key.
The display now shows the SYS SETUP menu screen.

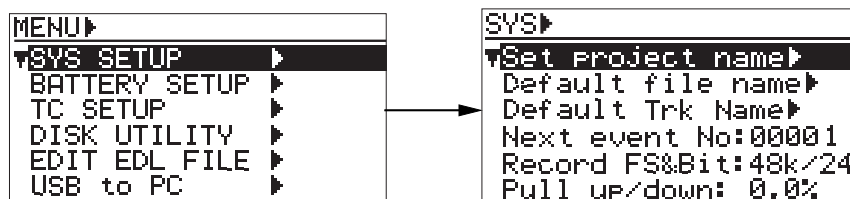

- 3) Use the [MENU] dial to select the “Diagnoses” menu item and press the [ENTER/YES] key.
The current setting starts flashing and you can now select the desired option.

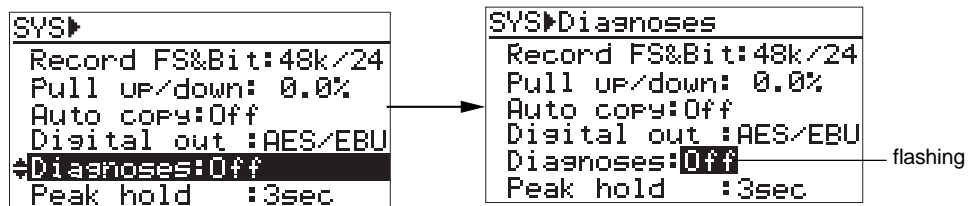

Options	
You can select from among “On” and “Off” (the default is “On”).	
On	Creates a diagnoses file which logs errors during recording, etc.
Off	Does not create a diagnoses file.

- 4) Use the [MENU] dial to select the desired option and press the [ENTER/YES] key to confirm your setting.
- 5) Press the [EXIT] key repeatedly until you exit the MENU mode.

Peak hold time setting [Peak hold]

The “Peak hold” menu item sets the peak hold time of the peak level meters.

- 1) While the unit is stopped, press the [SHIFT] key to light the SHIFT indicator, followed by the [ENTER/YES] key.
- 2) While “SYS SETUP” is highlighted, press the [ENTER/YES] key.
The display now shows the SYS SETUP menu screen.

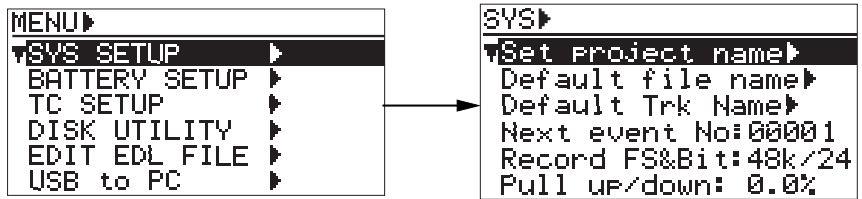

- 3) Use the [MENU] dial to select the “Peak hold” menu item and press the [ENTER/YES] key.
The current setting starts flashing and you can now select the desired option.

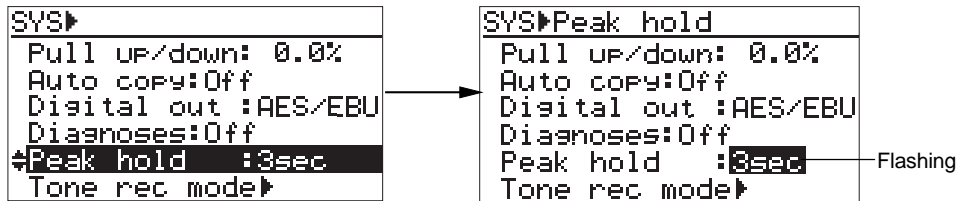

Options

You can set the time between “0sec.” and “9sec.” in one second step or infinity (∞)
(the default is “3sec.”).

* When “∞” is selected, you can clear the peak hold indication by pressing the [CLEAR] key.

- 4) Use the [MENU] dial to select the desired option and press the [ENTER/YES] key to confirm your setting.
- 5) Press the [EXIT] key repeatedly until you exit the MENU mode.

Slate tone/pop tone recording mode setting [Tone rec mode]

The “Tone rec mode” menu item sets the recording time and mode of the slate tone, as well as the recording mode of the pop tone. The slate tone is recorded at the beginning of a file, while the pop tone is recorded at the end of a file. The setting is stored to the Flash ROM of the unit.

- 1) While the unit is stopped, press the [SHIFT] key to light the SHIFT indicator, followed by the [ENTER/YES] key.
- 2) While “SYS SETUP” is highlighted, press the [ENTER/YES] key.
The display now shows the SYS SETUP menu screen.

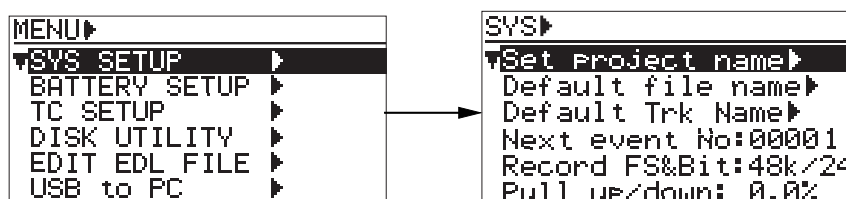

- 3) Use the [MENU] dial to select the “Tone rec mode” menu item and press the [ENTER/YES] key.
You can make tone rec time, tone rec On/Off and end pop tone On/Off settings.

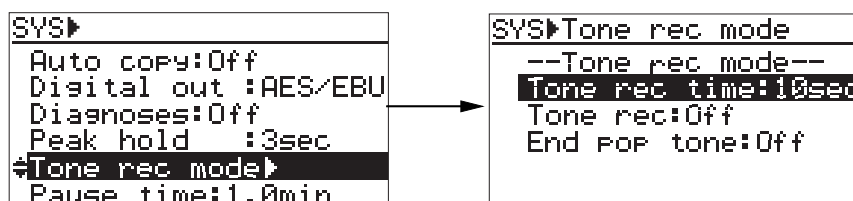

• Tone rec time setting

Use the [MENU] dial to select the “Tone rec time” and press the [ENTER/YES] key.
The current setting starts flashing.

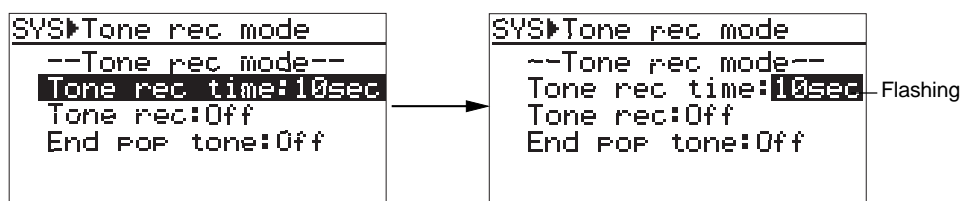

Use the [MENU] dial to select a desired option and press the [ENTER/YES] key to confirm your setting.

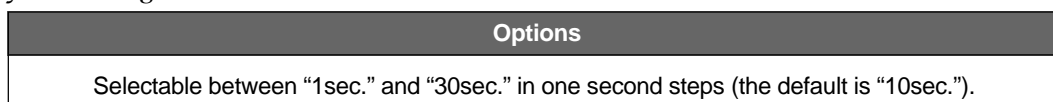

• Tone rec On/Off setting

Use the [MENU] dial to select the “Tone rec” and press the [ENTER/YES] key.
The current setting starts flashing.

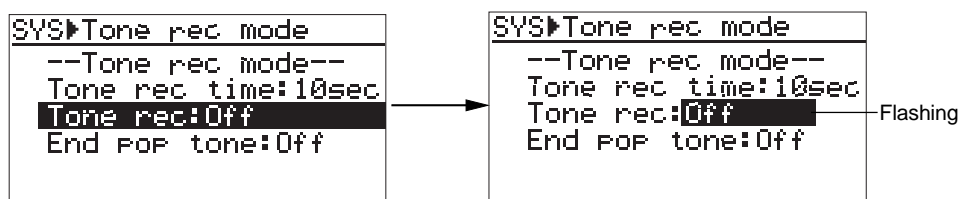

Use the [MENU] dial to select a desired option and press the [ENTER/YES] key to confirm your setting.

Options	
Selectable between "Off", "TONE" and "4POP TONE" (the default is "Off").	
Off	No slate or pop tone is recorded.
TONE	The slate tone at 1kHz is recorded for the duration set by "Tone rec time".
4 POP TONE	The pop tone at 1kHz is recorded. The cycle of 0.5 sec tone and 0.5 sec mute recording is made four times repeatedly.

• **End pop tone setting**

Use the [MENU] dial to select the "End pop tone" and press the [ENTER/YES] key. The current setting starts flashing.

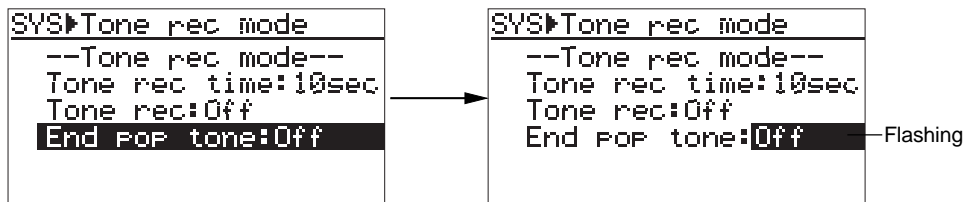

Use the [MENU] dial to select a desired option and press the [ENTER/YES] key to confirm your setting.

Options	
Selectable between "On" and "Off" (the default is "Off").	
On	The 1kHz pop tone is recorded at the end of recording.
Off	The 1kHz pop tone is not recorded at the end of recording.

- 4) Press the [EXIT] key repeatedly until you exit the MENU mode.

Pause cancel time setting [Pause time]

The “Pause time” menu item sets the pause cancel time. After the pause cancel time has passed since the recorder entered the pause mode, the recorder automatically cancels the pause mode and stops.

- 1) While the unit is stopped, press the [SHIFT] key to light the SHIFT indicator, followed by the [ENTER/YES] key.
- 2) While “SYS SETUP” is highlighted, press the [ENTER/YES] key.
The display now shows the SYS SETUP menu screen.

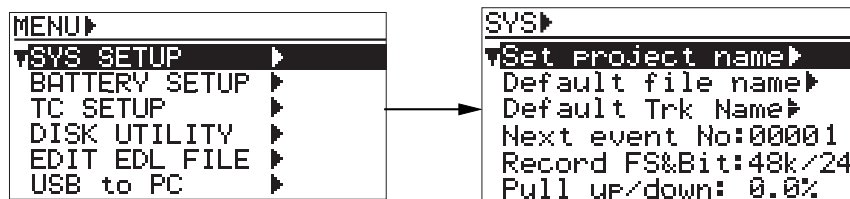

- 3) Use the [MENU] dial to select the “Pause time” menu item and press the [ENTER/YES] key.
The current setting starts flashing and you can now select the desired option.

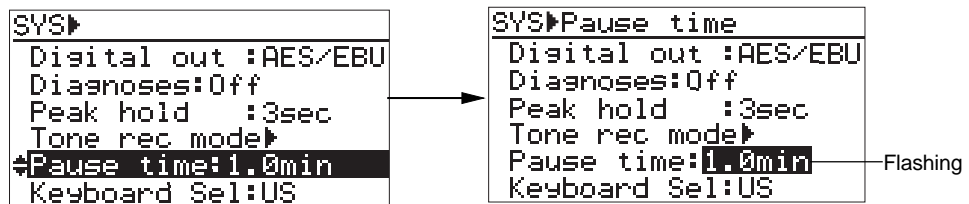

Options

You can set the time between “0.1min.” and “9.9min.” in 0.1 minute step or infinity (∞)
(the default is “1.0min”).

- 4) Use the [MENU] dial to select the desired option and press the [ENTER/YES] key to confirm your setting.
- 5) Press the [EXIT] key repeatedly until you exit the MENU mode.

USB keyboard type setting [Keyboard Sel]

The “Keyboard Sel” menu item selects the type of a USB keyboard connected to the [USB (KYBD)] connector. The setting is stored to the Flash ROM of the unit.

- 1) While the unit is stopped, press the [SHIFT] key to light the SHIFT indicator, followed by the [ENTER/YES] key.
- 2) While “SYS SETUP” is highlighted, press the [ENTER/YES] key.
The display now shows the SYS SETUP menu screen.

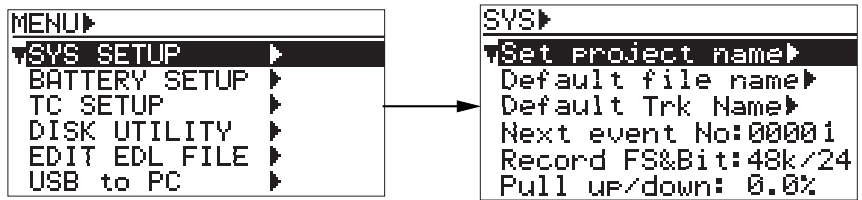

- 3) Use the [MENU] dial to select the “Keyboard Sel” menu item and press the [ENTER/YES] key.
The current setting starts flashing and you can now select the desired option.

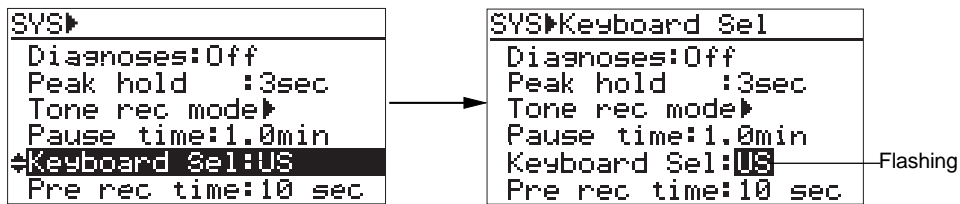

Options	
You can select between “US” and “JAPAN” (the default is “US”).	
US	A US keyboard can be connected.
JAPAN	A Japanese keyboard can be connected.

- 4) Use the [MENU] dial to select the desired option and press the [ENTER/YES] key to confirm your setting.
- 5) Press the [EXIT] key repeatedly until you exit the MENU mode.

Pre recording time setting [Pre rec time]

The “Pre rec time” menu item sets the pre recording time of audio pooled in the buffer. When starting recording while the Pre rec mode is set to “On”, recording is made from the audio pooled in the buffer. This prevents missing the start of a take. The setting is stored to the Flash ROM of the unit.

- 1) While the unit is stopped, press the [SHIFT] key to light the SHIFT indicator, followed by the [ENTER/YES] key.

- 2) While “SYS SETUP” is highlighted, press the [ENTER/YES] key.
The display now shows the SYS SETUP menu screen.

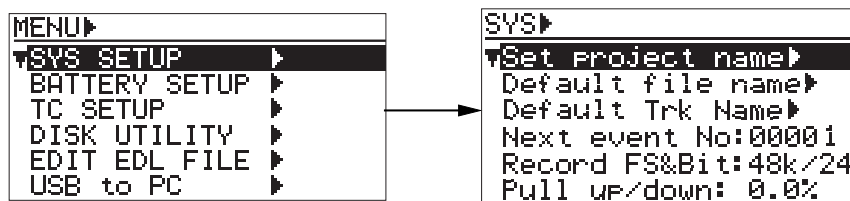

- 3) Use the [MENU] dial to select the “Pre rec time” menu item and press the [ENTER/YES] key.
The current setting starts flashing and you can now select the desired option.

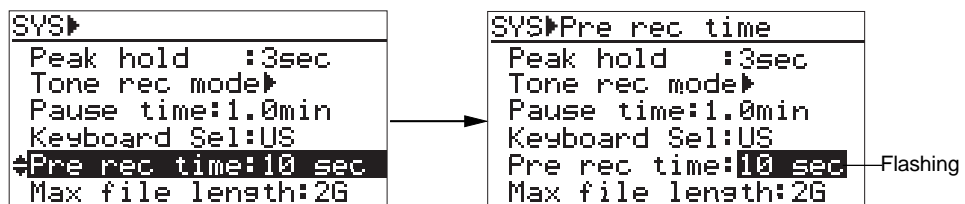

Options

Selectable between “1sec.” and “10sec.” in one second steps (the default is “10sec.”).

<Note>: If you execute pre recording at 88.2k or 96k, the pre recording time automatically reduces to half the selected value. If you execute pre recording at 176.4k or 192k, the pre recording time automatically reduces to quarter the selected value. For example, if the pre recording time is set to ten seconds at 88.2k Fs recording, the buffer stores only five seconds of audio data. If the pre recording time is set to ten seconds at 192k Fs recording, the buffer stores only 2.5 seconds of audio data.

- 4) Use the [MENU] dial to select the desired option and press the [ENTER/YES] key to confirm your setting.
- 5) Press the [EXIT] key repeatedly until you exit the MENU mode.

Maximum file length setting [Max file length]

The “Max file length” menu item sets the maximum recording volume of a file. This setting is important especially for exporting audio file data of the unit to your PC, because each PC has the limitation of the volume of a file to be imported. The setting is stored to the Flash ROM of the unit.

- 1) While the unit is stopped, press the [SHIFT] key to light the SHIFT indicator, followed by the [ENTER/YES] key.
- 2) While “SYS SETUP” is highlighted, press the [ENTER/YES] key.
The display now shows the SYS SETUP menu screen.

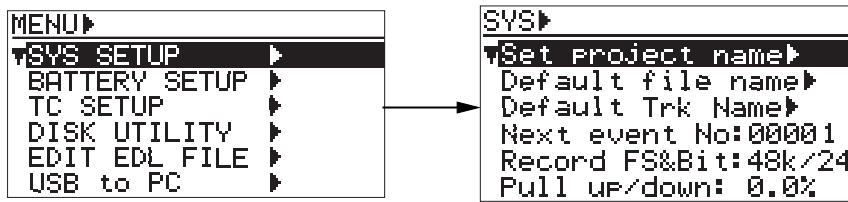

- 3) Use the [MENU] dial to select the “Max file length” menu item and press the [ENTER/YES] key.
The current setting starts flashing and you can now select the desired option.

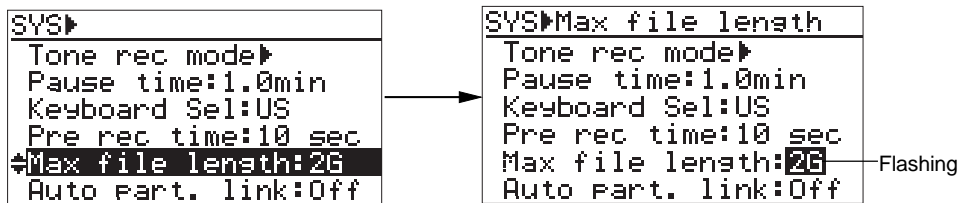

Options
Selectable between “2GB” and “4GB” (the default is “2GB”).

- 4) Use the [MENU] dial to select the desired option and press the [ENTER/YES] key to confirm your setting.
- 5) Press the [EXIT] key repeatedly until you exit the MENU mode.

<Note>: The remaining recordable time of the file which is shown during recording is calculated based on the “Max file length” setting. For example, if the remaining space of the disk is 4GB or more while “Max file length” is set to 4GB, the remaining recordable time of the file is calculated based on 4GB. If the remaining space of the disk is smaller than the “Max file length” setting, the remaining recordable time of the file is calculated based on disk remaining space. For example, if “Max file length” is set to 4GB while the remaining space of the disk is 2GB, the display shows the remaining time which is calculated based on 2GB.

<Note>: If the current file reaches to the maximum length during recording, the unit automatically create a new file and continues recording to it. During recording to an internal hard disk partition when the "Auto part. link" menu item (described on the next page) is set to "On", if there is no more recording space left in the current partition, the unit automatically continues recording to the next partition. See page 154 for details.

Continuous recording function [Auto part. link]

The “Auto part. link” menu item allows you to enable or disable the auto partition link function. By setting this item to "On" (while the default is "Off"), when there is no recording space left in the current partition during recording (after approximately 4.5 GB recording), the unit automatically creates a new file in the next available partition and continues recording to it. Therefore, you can make long recording which exceeds the capacity of a partition.

<Note>: You can make continuous recording by setting the “Auto part. link” item to “On” only when recording to a partition on the internal hard disk. It is not possible to make continuous recording when recording to a DVD-RAM disk. Also note that continuous recording is not possible when carrying out the auto copy function or dual drive recording.

- 1) While the unit is stopped, press the [SHIFT] key to light the SHIFT indicator, followed by the [ENTER/YES] key.

- 2) While “SYS SETUP” is highlighted, press the [ENTER/YES] key.

The display now shows the SYS SETUP menu screen.

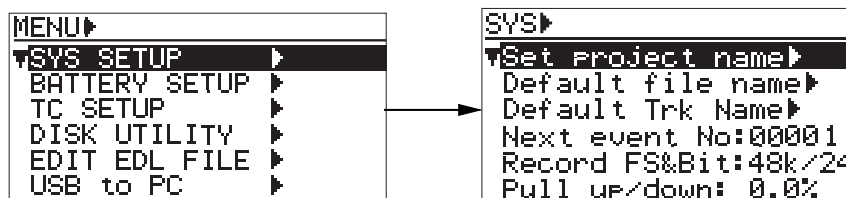

- 3) Use the [MENU] dial to select the “Auto part. link” menu item and press the [ENTER/YES] key.

The current setting starts flashing and you can now select the desired option.

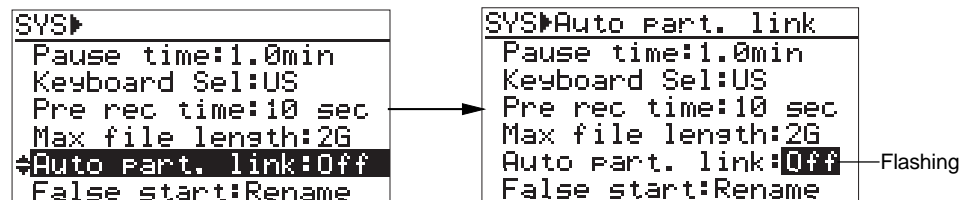

Options	
Selectable between “On” and “Off” (the default is “Off”).	
Off	At the point when there is no remaining space left on the current partition, recording ends.
On	At the point when there is no remaining space left on the current partition, the unit continues recording on the next partition.

- 4) Use the [MENU] dial to select the desired option and press the [ENTER/YES] key to confirm your setting.
- 5) Press the [EXIT] key repeatedly until you exit the MENU mode.

<Note>: To make continuous recording, the next partition to the current partition must have enough recordable space. It is recommended that no recording has been made to the next partition before making continuous recording.

The following shows how continuous recording is made depending on the setting of the “Max file length” item in the “SYS SETUP” menu of the MENU mode.

It is assumed to record 6GB audio data to partition 1 (PT01) with “Auto part. link” set to “On”.

• **When “Max file length” is set to “4GB”:**

Data is record to “4GB” and “0.5GB” files on partition 1 (PT01), and the rest 1.5GB data is recorded to a file on partition 2 (PT02). (The created files have sequential file numbers.)

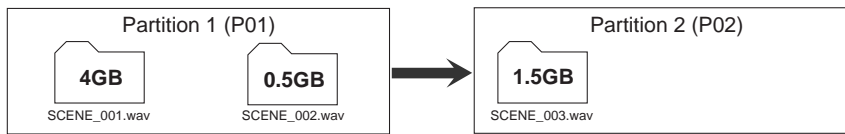

• **When “Max file length” is set to “2GB”:**

Data is record to two “2GB” and a “0.5GB” files on partition 1 (PT01), and the rest 1.5GB data is recorded to a file on partition 2 (PT02). (The created files have sequential file numbers.)

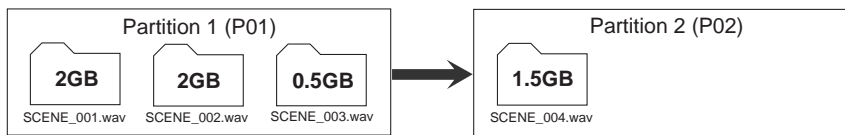

If data is too large for two partitions, partition 3 (PT03) is used.

If the next partition does not have recordable space, recording ends.

If “Auto part link” is set to “Off”, continuous recording is not made.

False start mode setting [False start]

The “False start” menu item selects whether the canceled file is kept on or deleted from the disk (or partition) when you cancel recording using the False start function.

- 1) While the unit is stopped, press the [SHIFT] key to light the SHIFT indicator, followed by the [ENTER/YES] key.
- 2) While “SYS SETUP” is highlighted, press the [ENTER/YES] key.
The display now shows the SYS SETUP menu screen.

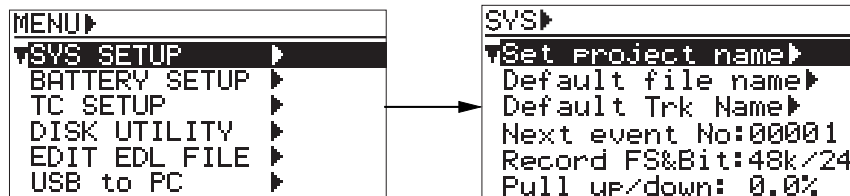

- 3) Use the [MENU] dial to select the “False start” menu item and press the [ENTER/YES] key.
The current setting starts flashing and you can now select the desired option.

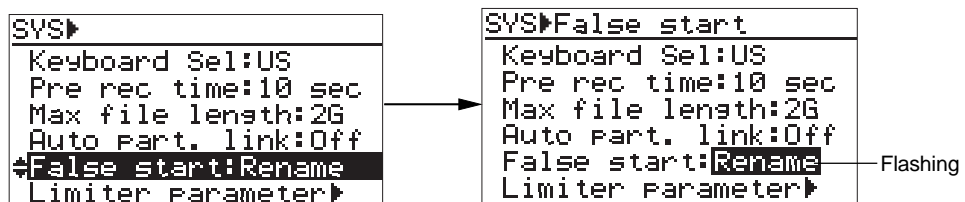

Options	
Selectable between “Rename” and “Delete” (the default is “Rename”).	
Rename	<p>When the False start function is executed, the take number decreases by one (i.e. returns to the previous take number) and the canceled audio file is stored as a file name starting by “- nn” followed by the original name. “nn” shows the number. Up to 100 canceled files (starting by -, - 1 through - 99) can be stored. The following examples show how the file names are given.</p> <p><Examples> After the first False start: Scene1_001.wav -> - Scene1_001.wav After the second False start Scene1_001.wav -> - 1Scene1_001.wav After the 100th False start Scene1_001.wav -> - 99Scene1_001.wav</p> <p>You can check stored files from the file selection screen (which can be shown by pressing the [FILE SEL] key).</p>
Delete	<p>After executing the False start function, the unsuccessful file is completely deleted and the disk remaining time returns to the value before the last recording is made. The take number decreases by one (returns to the previous take number).</p>

<Note>: When the “False start” menu item is set to “Rename”, each time you execute False start, the disk remaining time decreases.

- 4) Use the [MENU] dial to select the desired option and press the [ENTER/YES] key to confirm your setting.
- 5) Press the [EXIT] key repeatedly until you exit the MENU mode.

Limiter parameter setting [Limiter parameter]

The “Limiter parameter” menu item makes parameter setting for the limiter.

- 1) While the unit is stopped, press the [SHIFT] key to light the SHIFT indicator, followed by the [ENTER/YES] key.
- 2) While “SYS SETUP” is highlighted, press the [ENTER/YES] key.

The display now shows the SYS SETUP menu screen.

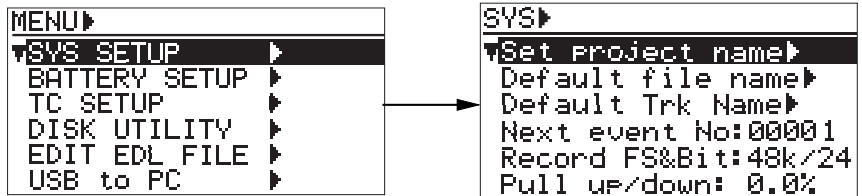

- 3) Use the [MENU] dial to select the “Limiter parameter” menu item and press the [ENTER/YES] key. You can set “Grouping”, “Threshold” and “Ratio” parameters.

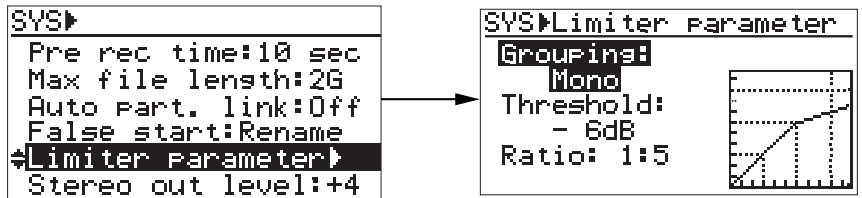

• Grouping setting

Use the [MENU] dial to select the “Grouping” and press the [ENTER/YES] key. The current setting starts flashing.

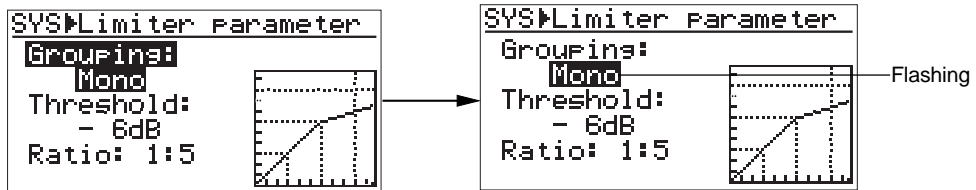

Use the [MENU] dial to select a desired option and press the [ENTER/YES] key to confirm your setting.

Options	
Selectable between “Mono” and “1-4” (the default is “Mono”).	
Mono	The limiter for each channel works independently.
1-4	Channels 1 through 4 are grouped, and limiters for channels 1 through 4 work the same according to the input levels of channels 1 through 4.

*The limiter for the stereo buss is always L-R linked.

• Threshold level setting

Use the [MENU] dial to select the “Threshold” and press the [ENTER/YES] key. The current setting starts flashing.

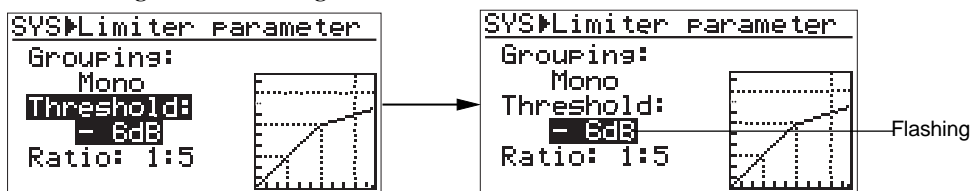

Use the [MENU] dial to select a desired option and press the [ENTER/YES] key to confirm your setting.

Options
Selectable between “-12dBFS” and “-6dBFS” (the default is “-6dBFS”).

• **Ratio setting**

Use the [MENU] dial to select the “Ratio” and press the [ENTER/YES] key. The current setting starts flashing.

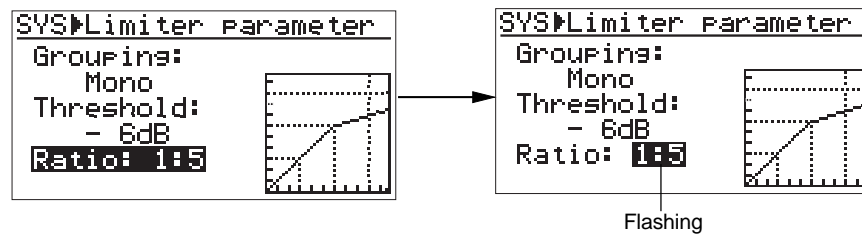

Use the [MENU] dial to select a desired option and press the [ENTER/YES] key to confirm your setting.

Options
Selectable between “1: 3” and “1: 5” (the default is “1: 5”).

- 4) Press the [EXIT] key repeatedly until you exit the MENU mode.

ANALOG OUT nominal level setting [Stereo out level]

The "Stereo out level" menu item selects the nominal output level of the [ANALOG OUT]. According to the device connected to the [ANALOG OUT] connector, select the level appropriately.

- 1) While the unit is stopped, press the [SHIFT] key to light the SHIFT indicator, followed by the [ENTER/YES] key.
- 2) While "SYS SETUP" is highlighted, press the [ENTER/YES] key.
The display now shows the SYS SETUP menu screen.

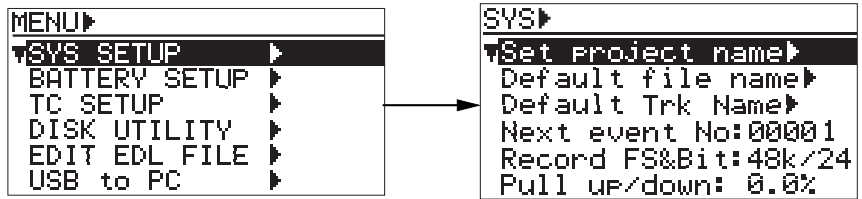

- 3) Use the [MENU] dial to select the "Stereo out level" menu item and press the [ENTER/YES] key.
The current setting starts flashing and you can now select the desired option.

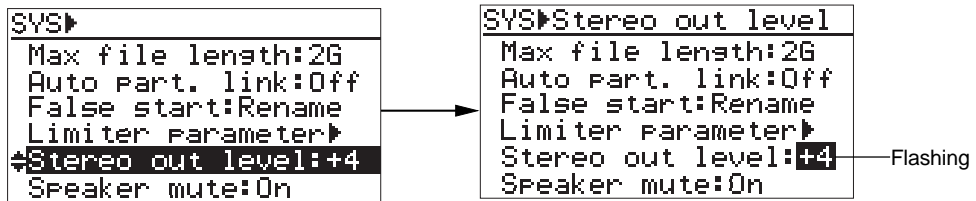

Options
Selectable between "+4dBu", "-10dBu" and "-60dBu" (the default is "+4dBu").

- 4) Use the [MENU] dial to select the desired option and press the [ENTER/YES] key to confirm your setting.
- 5) Press the [EXIT] key repeatedly until you exit the MENU mode.

Monitor speaker mute setting [Speaker mute]

The “Speaker mute” menu item selects whether or not the internal monitor speaker is muted when the unit is not in playback mode. The setting of this item is stored to PD204 flash ROM.

- 1) While the unit is stopped, press the [SHIFT] key to light the SHIFT indicator, followed by the [ENTER/YES] key.
- 2) While “SYS SETUP” is highlighted, press the [ENTER/YES] key.
The display now shows the SYS SETUP menu screen.

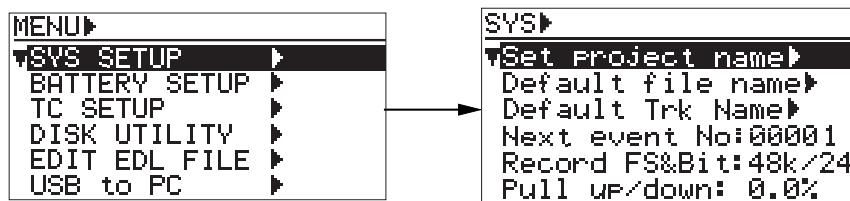

- 3) Use the [MENU] dial to select the “Speaker mute” menu item and press the [ENTER/YES] key.
The current setting starts flashing and you can now select the desired option.

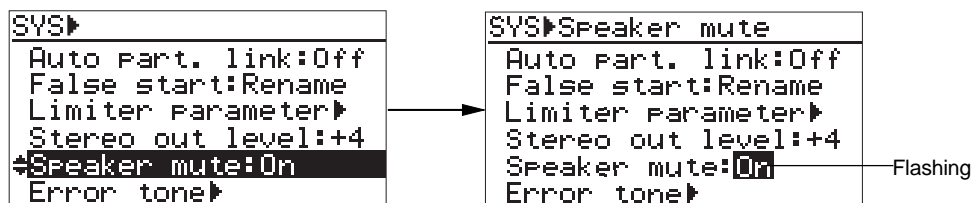

Options

You can select between “On” and “Off” (the default is “On”).

- 4) Use the [MENU] dial to select the desired option and press the [ENTER/YES] key to confirm your setting.
- 5) Press the [EXIT] key repeatedly until you exit the MENU mode.

Error tone output setting [Error tone]

The “Error tone” menu item selects whether generating the error tone (warning tone) or not for each of four kinds of troubles (see below) independently.

1. A write error happens during recording. [Write error]
2. The peak indicator lights due to input overload during analog recording or clipping of the stereo buss. [Input clip]
3. The battery voltage drops below the threshold voltage set by the "BATT. warning" menu item. [BATT warning]
4. The remaining recording time of a disk (or a partition) gets under the specified time. [Disk warning]

- 1) While the unit is stopped, press the [SHIFT] key to light the SHIFT indicator, followed by the [ENTER/YES] key.
- 2) While “SYS SETUP” is highlighted, press the [ENTER/YES] key.
The display now shows the SYS SETUP menu screen.

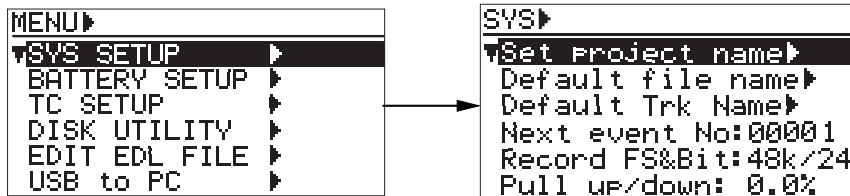

- 3) Use the [MENU] dial to select the “Error tone” menu item and press the [ENTER/YES] key.
You can select “On” or “Off” of the error tone for “Write error”, “Input clip” and “BATT warning”, as well as can set the time for “Disk warning”.

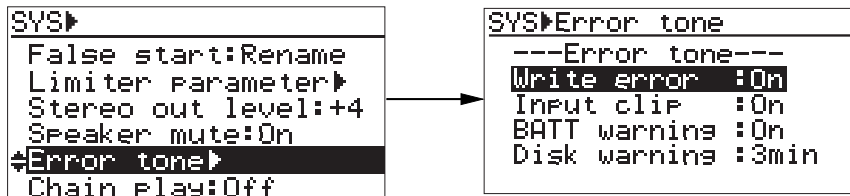

• **Write error On or Off setting**

Use the [MENU] dial to select the “Write error” and press the [ENTER/YES] key.
The current setting starts flashing and you can now select the desired option.

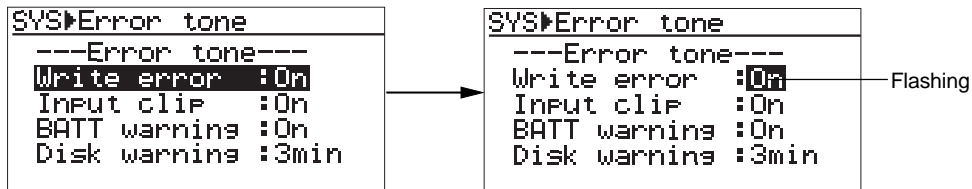

Use the [MENU] dial to select the desired option and press the [ENTER/YES] key to confirm your setting.

Options
You can select between “On” and “Off” (the default is “On”).
If a write error occurs while you set "Write error" to "On", _____ the warning tone is output by the pattern on the right.

• Input clip On/Off setting

Use the [MENU] dial to select the “Input clip” and press the [ENTER/YES] key. The current setting starts flashing and you can now select the desired option.

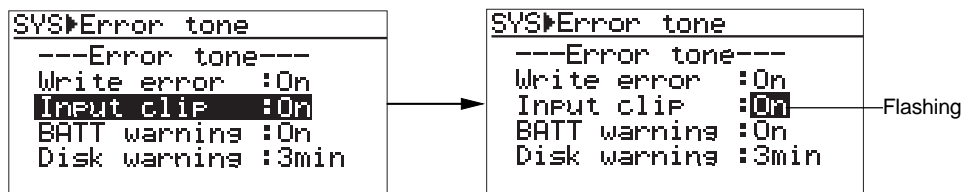

Use the [MENU] dial to select the desired option and press the [ENTER/YES] key to confirm your setting.

Options	
You can select between “On” and “Off” (the default is “On”).	
If the peak indicator lights due to input overload during analog recording or clipping of stereo buss while you set "Input clip" to "On", the warning tone is output by the pattern on the right.	_ _ _ _ _

• BATT warning On /Off setting

Use the [MENU] dial to select the “BATT warning” and press the [ENTER/YES] key. The current setting starts flashing and you can now select the desired option.

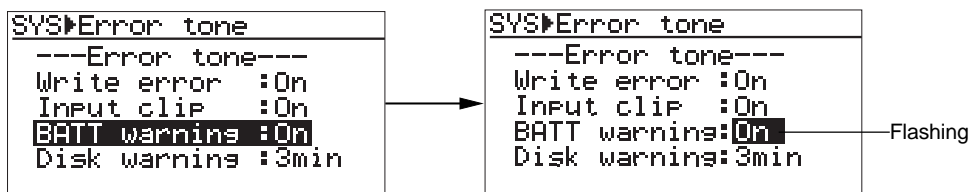

Use the [MENU] dial to select the desired option and press the [ENTER/YES] key to confirm your setting.

Options	
You can select between “On” and “Off” (the default is “On”).	
If the battery voltage drops below the threshold voltage set by the "BATT. warning" (BATTERY SETUP) menu item while you set "BATT warning" to "On", the warning tone is output by the pattern on the right. If the warning tone above is output during recording, recording automatically stops after one minute.	_ _ _ _ _

<Note>: For details about how to set the battery threshold voltage for warning, see "Battery warning setting" on page 172.

• **Disk warning time setting**

Use the [MENU] dial to select the “Disk warning” and press the [ENTER/YES] key. The current setting starts flashing and you can now select the desired option.

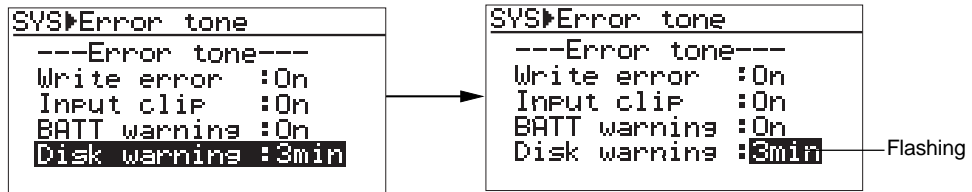

Use the [MENU] dial to select the desired option and press the [ENTER/YES] key to confirm your setting.

Options	
Selectable “Off” or between “1min.” and “9min.” in one minute steps (the default is “3min.”).	
If the remaining recording time of a disk (or a partition) gets under the specified time while you set "Disk warning" to "On", the warning tone is output by the pattern on the right.	— — — — —

- 4) Press the [EXIT] key repeatedly until you exit the MENU mode.

Chain play mode setting [Chain play]

The “Chain play” menu item selects how the recorder behaves after playback of an audio file finishes.

By default, the recorder stops at the playback end point. However, you can make the recorder pause at the beginning of the next audio file or play the next audio file until all audio files on a disk (or a partition) are played back.

- 1) While the unit is stopped, press the [SHIFT] key to light the SHIFT indicator, followed by the [ENTER/YES] key.
- 2) While “SYS SETUP” is highlighted, press the [ENTER/YES] key.
The display now shows the SYS SETUP menu screen.

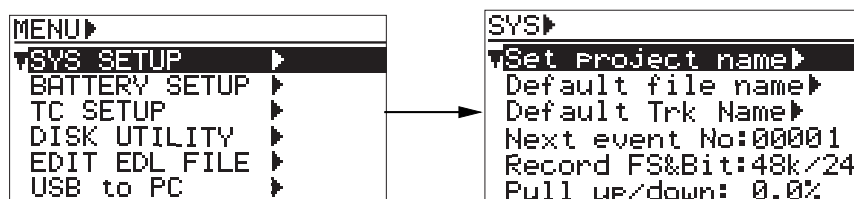

- 3) Use the [MENU] dial to select the “Chain play” menu item and press the [ENTER/YES] key.
The current setting starts flashing and you can now select the desired option.

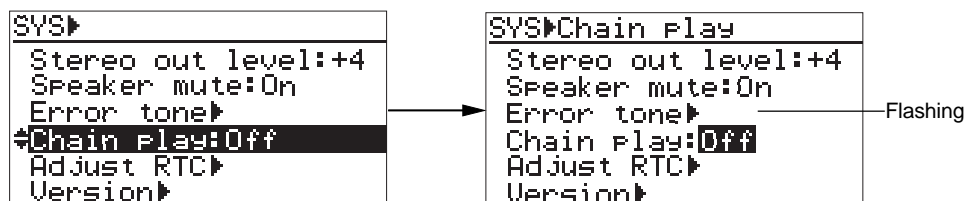

Options	
You can select from among “Off”, “Pause” and “AutoPly (the default is “Off”).	
Off	The unit stops when an audio file is played back to the end.
Pause	The unit pauses at the beginning of the next audio file when an audio file is played back to the end.
AutoPly	The unit continuously plays back all audio files following the current file on the current disk (or partition) in the numerical order. When the unit plays back the last file to the end, it stops.

- 4) Use the [MENU] dial to select the desired option and press the [ENTER/YES] key to confirm your setting.
- 5) Press the [EXIT] key repeatedly until you exit the MENU mode.

ROM version checking [Version]

Selecting “Version” allows you to view the software ROM version number and creation/revision date.

- 1) While the unit is stopped, press the [SHIFT] key to light the SHIFT indicator, followed by the [ENTER/YES] key.
- 2) While “SYS SETUP” is highlighted, press the [ENTER/YES] key.
The display now shows the SYS SETUP menu screen.

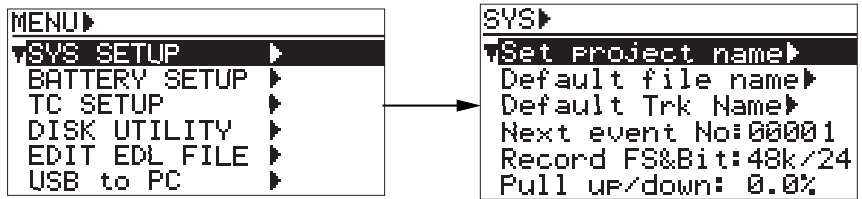

- 3) Use the [MENU] dial to select the “Version” menu item and press the [ENTER/YES] key.
You can check the software ROM version number and creation/revision date.

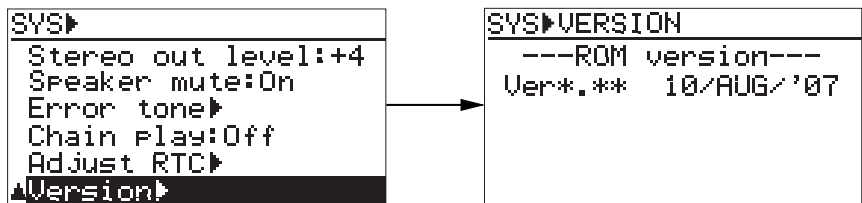

- 4) Press the [EXIT] key repeatedly until you exit the MENU mode.

BATTERY SETUP menu

In the BATTERY SETUP menu, the following items for battery related settings and screens are available.

Menu item	Setting/function
BATT. warning	Sets the threshold battery voltage for generating the warning tone.
DC-IN warning	Sets the threshold DC-IN voltage for generating the warning tone.
Power priority	Sets the priority of power supply (DC-IN or battery).
Active battery	Sets the battery priority when using multiple batteries.
BATT. Remain	Displays remaining time until battery voltage drops down to the "BATT. warning" threshold voltage.
BATT. Status	Reads and displays the information of a BMS battery.

* BMS: Stands for Battery Management System. a BMS battery memorizes all data such as battery voltages, currents, capacities etc. By using the data, the PD204 can manage the battery precisely.

Battery low voltage warning setting [BATT. warning]

Using the "BATT. warning" item, you can set the threshold low battery voltage for generating the warning tone. When the battery voltage drops down to the threshold voltage for warning, you can hear the warning tone via headphones.

To hear the warning tone, you must set the "BATT. warning" item on the "Error tone" menu item in the "SYS SETUP" menu of the MENU mode to "On". (The default is "On". See page 160 for details.) You can also check the remaining time until battery voltage drops down to the threshold voltage via the "BATT. Remain" menu item. See page 172 for details.

- 1) While the unit is stopped, press the [SHIFT] key followed by the [ENTER/YES] key.
- 2) Use the [MENU] dial to select the "BATTERY SETUP" menu and press the [ENTER/YES] key. The display shows the screen for battery-related settings.

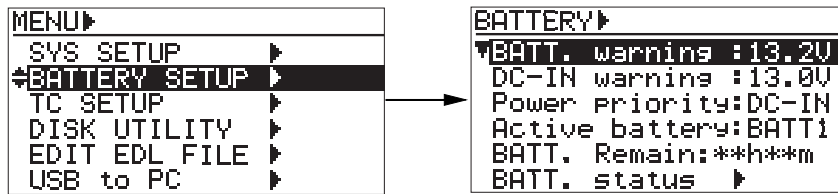

- 3) While "BATT. warning" is highlighted, press the [ENTER/YES] key. The current setting starts flashing. You can now select a voltage from the following.

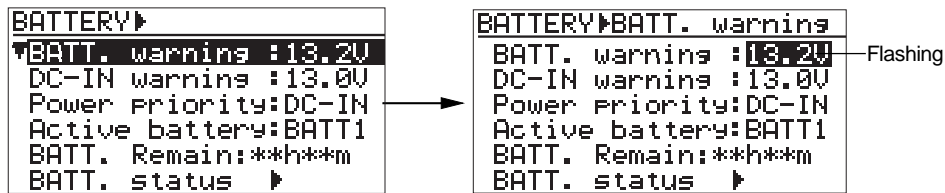

Available options for a BMS battery
12.0V, 12.3V, 12.6V, 12.9V, 13.2V (default), 13.5V, and 13.8V. * 12.9V or higher is recommended.
Available options for a non-BMS battery
10.5V, 11.0V, 11.5V, 12.0V, 12.3V, 12.6V, 12.9V, 13.2V (default), 13.5V, and 13.8V. * we recommend the following setting depending on the battery type. For NiCd battery: 10.5V For Lithium Ion battery: 12.9V or higher

- 4) Use the [MENU] dial to select a desired option and press the [ENTER/YES] key to confirm your setting.
- 5) Press the [EXIT] key repeatedly until you exit the MENU mode.

<Note>: When you make recording using a BMS battery, if the remaining time until the battery drops down to the threshold voltage becomes less than one minute, the warning message appears on the display. And after a minute passes, the unit automatically stops recording. When you make recording using a non-BMS battery, if the battery voltage reaches the threshold voltage, the warning message appears on the display. And after a minute, the unit automatically stop recording. If another spare battery is also mounted, the unit automatically switches the power source to it after the warning message appears on the display. When you make recording using a lithium ion battery, we recommend setting the threshold voltage to around 12.9V because the output voltage of a lithium ion battery drops down rapidly after it reaches around 12.9V.

DC-IN low voltage warning setting [DC-IN warning]

Using the "DC-IN warning" item, you can set the threshold low battery voltage for generating the warning tone when an external battery is connected to the [DC-IN] connector. When the battery voltage drops down to the threshold voltage for warning, you can hear the warning tone via headphones.

- 1) While the unit is stopped, press the [SHIFT] key followed by the [ENTER/YES] key.
- 2) Use the [MENU] dial to select the "BATTERY SETUP" menu and press the [ENTER/YES] key. The display shows the screen for battery-related settings.

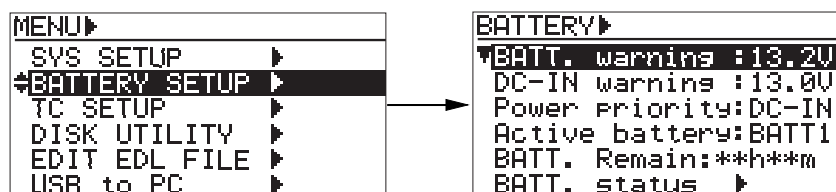

- 3) Use the [MENU] dial to select the "DC-IN warning" menu item and press the [ENTER/YES] key. The current setting starts flashing. You can now select a voltage from the following.

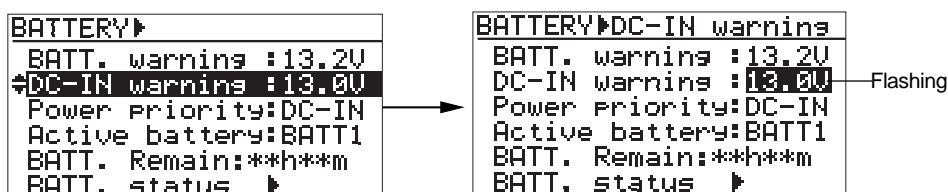

Available options for a BMS battery

10.5V to 13.5V in 0.5V steps (the default is 13.0V)

* We recommend the following setting depending on the battery type.

For NiCd battery: 10.5V or higher

For Lithium Ion battery: 12.5 ~ 13.0V or higher

- 4) Use the [MENU] dial to select a desired option and press the [ENTER/YES] key to confirm your setting.
- 5) Press the [EXIT] key repeatedly until you exit the MENU mode.

<Note> When you make recording using the power supplied from the [DC-IN] connector, if the power drops down to the threshold voltage, the warning message appears on the display. And after a minute passes, the unit automatically stops recording. However, if a battery is also mounted to the unit and the "Power priority" item is set to "DC-IN", the unit automatically switches the power source to the battery when the warning message appears on the display so you can continue recording.

Power supply priority setting [Power priority]

Using the "Power priority" item, you can set the power supply priority when you use both a battery and the [DC IN] connector.

For example, if you set the prior power supply to "DC-IN", the battery can be backup power and is used only when the "DC-IN" jack is cut off (power failure, disconnection, etc).

See "Battery setting examples" on pages 170 and 171 for the examples of power supply priority setting.

- 1) While the unit is stopped, press the [SHIFT] key followed by the [ENTER/YES] key.
- 2) Use the [MENU] dial to select the "BATTERY SETUP" menu and press the [ENTER/YES] key. The display shows the screen for battery-related settings.

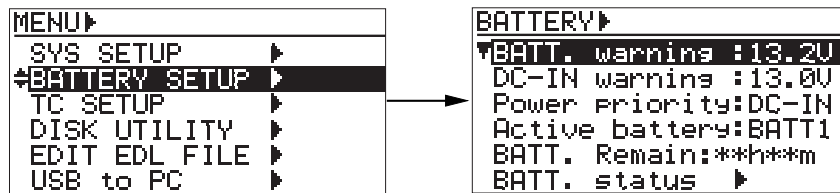

- 3) Use the [MENU] dial to select the "Power priority" menu item and press the [ENTER/YES] key. The current setting starts flashing. You can now select the prior power supply.

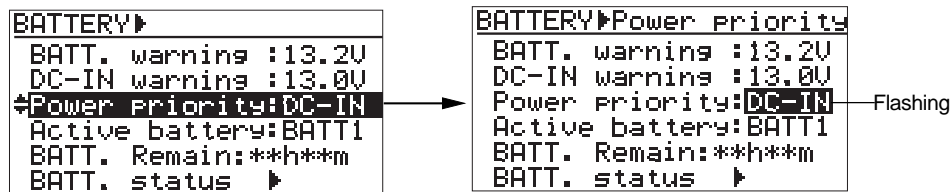

Available options
"DC-IN" and "BATT" (the default is "DC-IN".)

<Note>: If only either of the [DC-IN] or battery power is available, the available power is active regardless of the "Power priority" setting.

<Note>: When you set "Power priority" to "DC-IN", the battery automatically becomes active when the voltage of the power from the "DC-IN" connector drops down to the threshold voltage for warning or when the power cord to the "DC-IN" connector is disconnected.

<Note>: When you set "Power priority" to "BATT" and batteries are mounted to both the BATT1 and BATT2 mounts, if the battery power voltage of the prior battery drops down to the threshold voltage for warning, the other battery automatically becomes active. When a battery is mounted to either of the battery mounts, if the battery power voltage of the priory battery drops down to the threshold voltage for warning, the "DC-IN" power becomes active. When you set "Power priority" to "BATT", if the battery power drops down and the power source changes from the battery to the "DC-IN", the battery recovers temporarily, however, the power source do not return to the battery. Note that if you replace the battery to the fully charged one, the power source automatically switches back to the battery.

- 4) Use the [MENU] dial to select a desired option and press the [ENTER/YES] key to confirm your setting.
- 5) Press the [EXIT] key repeatedly until you exit the MENU mode.

Battery priority setting [Active battery]

Using the "Active battery" item, you can select the prior battery (BATT1 or BATT2) when you set batteries to both the BATT1 and BATT2.

See "Battery setting examples" on pages 170 and 171 for the examples of battery priority setting. The setting you make using this item is reflected to the "POWER" area on the display. You can also make the prior battery setting via the quick setup mode (see page 77).

<Note>: If the voltage of the prior battery drops down to the threshold voltage set via the "BATT warning" item, the unit change the active battery to the other one in the manner described below. Note that when the unit changes the active battery, the setting of the "Active battery" item also changes.

- BMS battery: If the time until the battery voltage drops down to the threshold voltage set via the "BATT warning" item becomes less than one minute, the active battery changes automatically.
- Non BMS battery: If the battery drops down to the threshold voltage set via the "BATT warning" item, the display shows the "warning" message and the active battery changes automatically.

Note that even if you replace the prior battery with a new one, the active battery does not change. If you want to make the replaced battery active, you must make setting of the "Active battery" item again.

- 1) While the unit is stopped, press the [SHIFT] key followed by the [ENTER/YES] key.
- 2) Use the [MENU] dial to select the "BATTERY SETUP" menu and press the [ENTER/YES] key. The display shows the screen for battery-related settings.

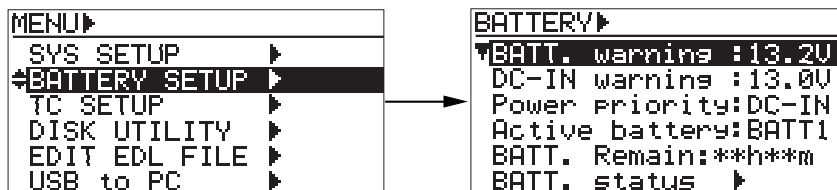

- 3) Use the [MENU] dial to select the "Active battery" menu item and press the [ENTER/YES] key. The current setting starts flashing. You can now select the prior battery.

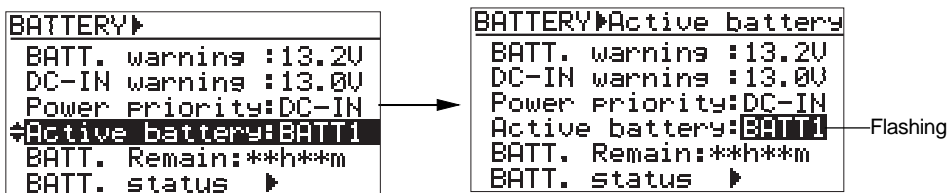

Available options
"BATT1" and "BATT2" (the default is "BATT1".)

<Note>: You cannot select an option whose battery power voltage is lower than the threshold voltage.

<Note>: If a battery is set to either of "BATT1" or "BATT2", or if no battery is set, you cannot make selection of this item.

- 4) Use the [MENU] dial to select a desired option and press the [ENTER/YES] key to confirm your setting.
- 5) Press the [EXIT] key repeatedly until you exit the MENU mode.

<Battery setting examples>

<Example 1>: The [DC-IN] power is normally used while a battery set to battery mount 1 is standby for backup.

Power priority: DC-IN, Active battery: BATT1

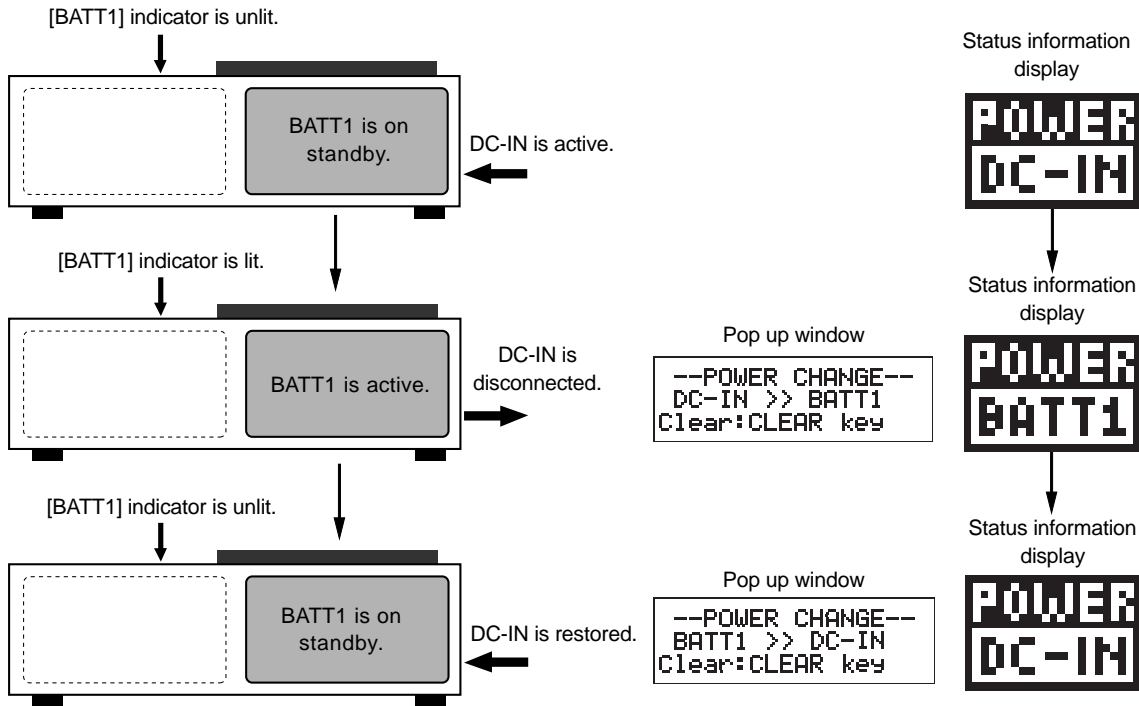

<Example 2>: The battery mounted on battery mount 1 is normally used while the [DC-IN] is on standby for backup.

Power priority: BATT., Active battery: BATT1

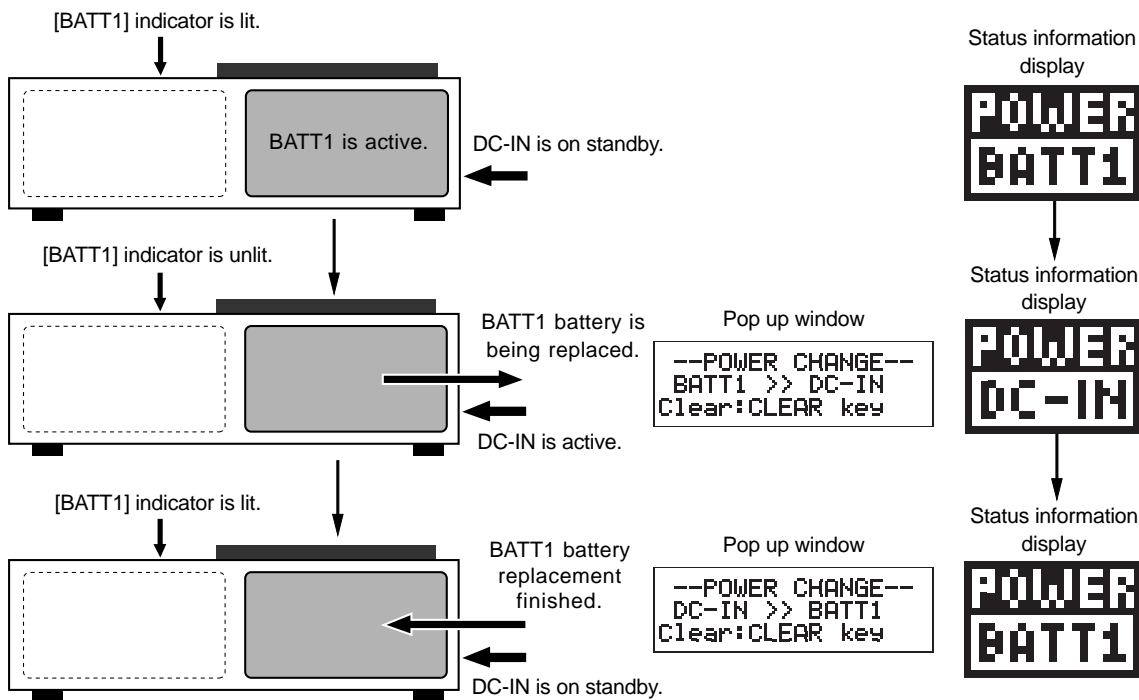

<Example 3>: Batteries are mounted on both battery mounts and can be used continuously.
Power priority: BATT. (If no power is supplied to "DC-IN", this item has no effect.)
Active battery: BATT1 (You may select BATT1 or BATT2 whichever you like. Each time battery is replaced, the active battery automatically changes, though you can manually select it.)

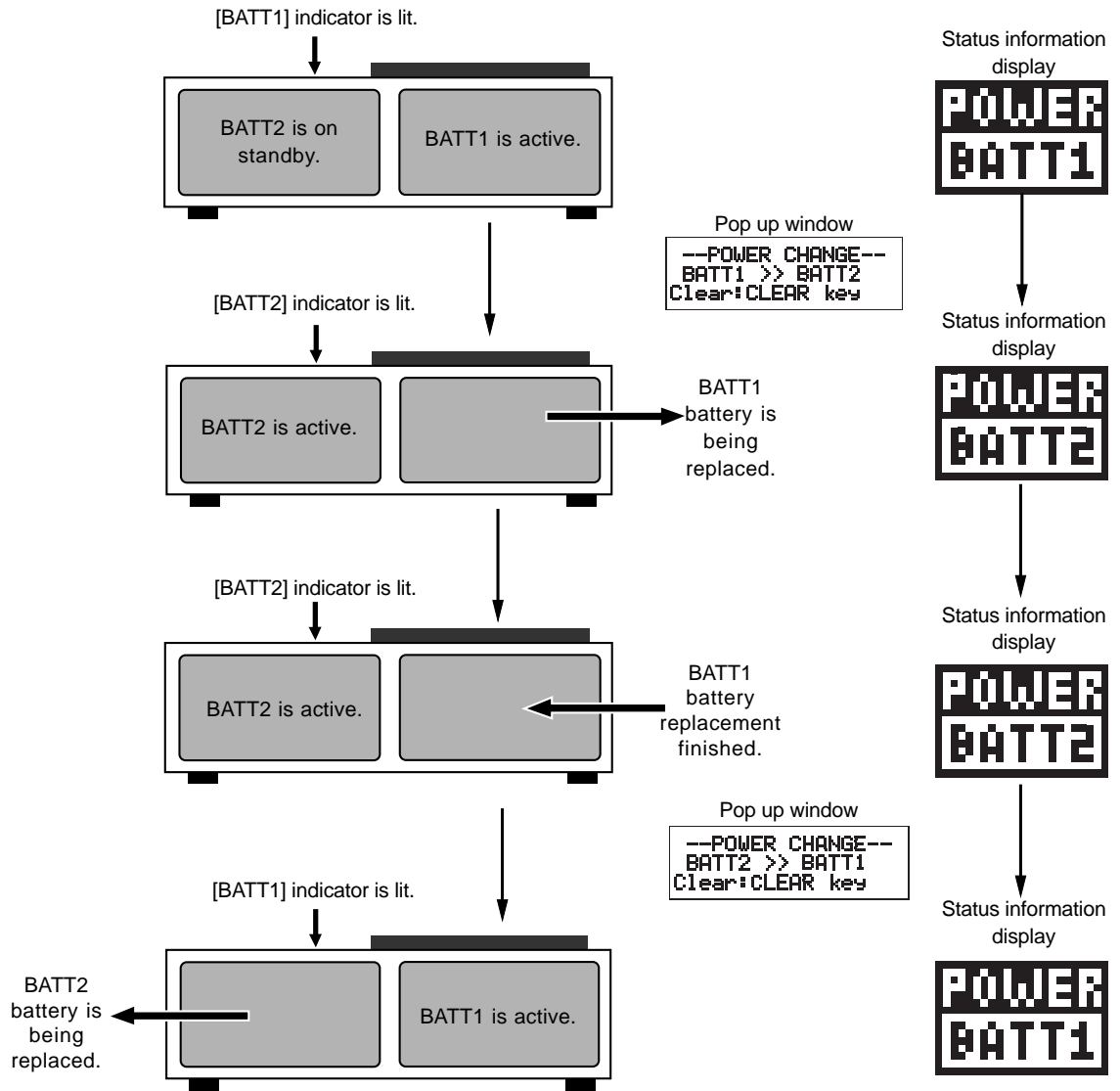

Battery remaining time [BATT. Remain]

When you use a battery with BMS (Battery Management System), the "BATT. Remain" item shows the remaining time until the battery voltage reaches the threshold low voltage (set by the "BATT. warning" item) in one minute steps. You can also see the remaining time via the "BATT. status" item (see the next page).

- 1) While the unit is stopped, press the [SHIFT] key followed by the [ENTER/YES] key.
- 2) Use the [MENU] dial to select the "BATTERY SETUP" menu and press the [ENTER/YES] key. The display shows the screen for battery-related settings.

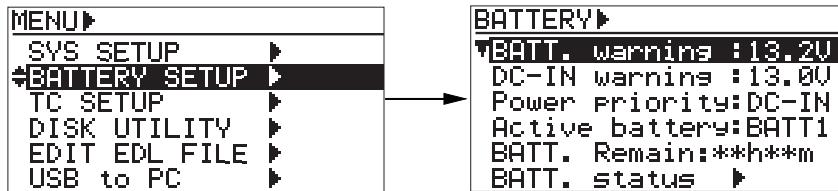

The remaining time until the battery voltage reaches the threshold low voltage is shown in one minute at the position indicated by an arrow below.

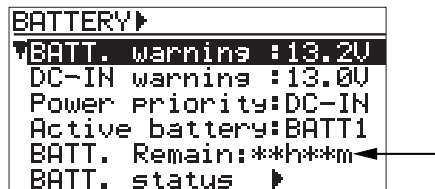

<Note>: The displayed time is calculated from the current power consumption so it varies depending on the condition. The unit display the remaining time only as a guide and we do not guarantee the time.

<Note>: When a non-BMS battery or the [DC-IN] power is active, "BATT. remain" does not display the remaining time. When a non-BMS battery is active, "--h --m" is shown. When [DC-IN] is active, "<DC-IN>" is shown.

<Note>: When batteries are linked (using PowerLink batteries), the average value calculated by the batteries is shown.

<Note>: When the battery priority is set by the "Active battery" item, the remaining time of the prior battery is shown. When the active battery changes, the remaining time of the other battery is shown.

<Note>: The "BATT Remain" item only displays the remaining time. Unlike the other menu items, pressing the [ENTER/YES] key does not change anything.

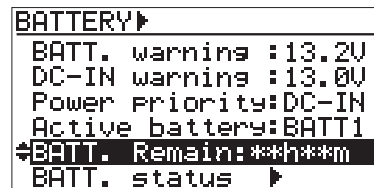

- 3) Press the [EXIT] key repeatedly until you exit the MENU mode.

Battery status [BATT. status]

The "BATT. status" item displays the information of a battery with BMS (Battery Management System).

- 1) While the unit is stopped, press the [SHIFT] key followed by the [ENTER/YES] key.
- 2) Use the [MENU] dial to select the "BATTERY SETUP" menu and press the [ENTER/YES] key. The display shows the screen for battery-related settings.

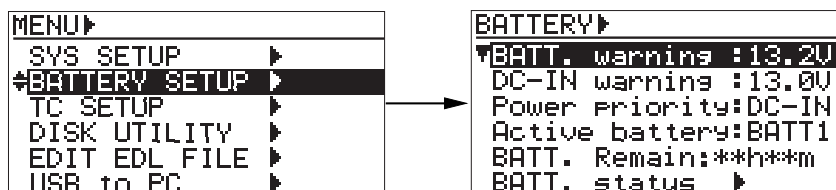

- 3) Use the [MENU] dial to select "BATT. status" menu item and press the [ENTER/YES] key. The unit reads BMS battery data and displays the following information.

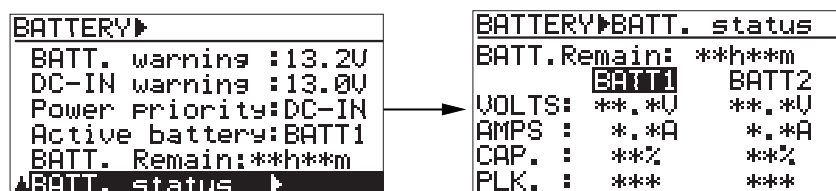

BATT. Remain	<p>Shows the remaining time until the battery voltage reaches the threshold low voltage in one minute steps.</p> <p><Note>: When batteries are linked (using PowerLink batteries), the average value calculated by the batteries is shown.</p> <p><Note>: When the battery priority is set by the "Active battery" item, the remaining time of the prior battery is shown. When the active battery changes, the remaining time of the other battery is shown.</p> <p><Note>: When a non-BMS battery is active, "--h --m" is shown. When [DC-IN] is active, "<DC-IN>" is shown.</p>
BATT1/BATT2	The currently used battery is highlighted.
VOLTS	Battery voltage is shown. For a non-BMS battery, the value is measured by the CPU of the PD204.
AMPS	Battery current is shown. For a non-BMS battery, "--A" is shown.
CAP.	Battery capacity is shown. For a non-BMS battery, "--%" is shown.
PLK.	Shows whether battery PowerLink is on or off. * Only when the battery is active, "ON" is shown. For a non-BMS battery, "---" is shown.

- 4) Press the [EXIT] key repeatedly until you exit the MENU mode.

TC SETUP menu

In the TC SETUP menu, 13 menu items for settings regarding time code recording/playback and synchronization to an external device are available.

Menu item	Setting/function
Sync clock	Selects the system clock.
Frame rate	Selects the time code frame rate.
Gen mode	Selects the generator mode of the internal TC generator.
Set Gen. TC	Sets TC generator start time and userbit when the generator mode is set to Free Run or Rec Run.
Set Gen Ubit	Selects userbit of output time code.
JAM mode	Selects the Jam mode when the generator mode is set to Free Run.
Sel. TC out	Selects output time code source.
Default LTC start	Sets the default LTC start time when no external time code is fed to the unit.
Edit LTC start	Sets the LTC start time of a playback file.
Rep TC Ubit	Sets userbit of playback time code.
Rep Pause TC	Selects On/Off of time code output while paused.
Recln via ExtTc	Selects on/off of automatic recording mode when receiving external time code.
TC PWR Timer	Timer off setting of the internal TC generator after the unit is powered off.

<Note>: You can bring up the TC SETUP menu by the following procedure as well as the procedure described on the next page.

- 1) **When the unit is stopped, press the [SHIFT] key to light the [SHIFT] indicator, followed by the [ENTER/YES] key.**
The unit enters MENU mode and brings up the MENU list screen for selecting the desired main menu.

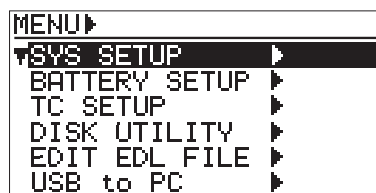

- 2) **Use the [MENU] dial to select the "TC SETUP" menu, and press the [ENTER/YES] key.**
The display now shows the TC SETUP menu screen.

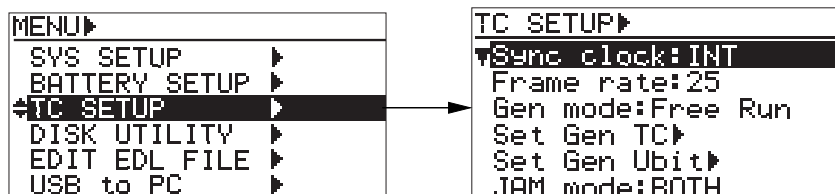

System clock selection [Sync clock]

Using the "Sync clock" menu item, you can select the system clock reference.

If you connect the PD204 to an external digital or video machine which does not have sync clock output facility, use the PD204 internal clock as the system master clock.

You can also set the system clock reference using the quick setup mode.

- 1) **When the unit is stopped, press the [SHIFT] key to light the [SHIFT] indicator, followed by the [TIME/TC SET] key.**

The display now shows the TC SETUP menu screen.

```

TC SETUP▶
▼Sync clock:INT
Frame rate:25
Gen mode:Free Run
Set Gen TC▶
Set Gen Ubit▶
JAM mode:BOTH
  
```

- 2) **While "Sync Clock" is highlighted, press the [ENTER/YES] key.**

The current setting starts flashing and you can now select the desired option.

```

TC SETUP▶
▼Sync clock:INT
Frame rate:25
Gen mode:Free Run
Set Gen TC▶
Set Gen Ubit▶
JAM mode:BOTH
  
```

→

```

TC SETUP▶Sync Clock
Sync clock:INT
Frame rate:25
Gen mode:Free Run
Set Gen TC▶
Set Gen Ubit▶
JAM mode:BOTH
  
```

Flashing

- 3) **Use the [MENU] dial to select the desired option, and press the [ENTER/YES] key to confirm your setting.**

Options	
You can select from among "INT", "Video", "Word" and "Digi in" (the default is "INT").	
INT	The unit is referenced to the internal clock master (default setting).
Video	The unit is referenced to external video clock received from the [WORD/VIDEO IN] connector.
Word	The unit is referenced to external word clock received from the [WORD/VIDEO IN] connector.
Digi in	The unit is referenced to digital audio input signal received from the [DIGITAL IN] connector.

- 4) **Press the [EXIT] key repeatedly until you exit the MENU mode.**

TC frame rate selection [Frame rate]

Using the "Frame rate" menu item, you can select the time code frame rate for recording. You can also select the TC frame rate using the quick setup mode.

- 1) **When the unit is stopped, press the [SHIFT] key to light the [SHIFT] indicator, followed by the [TIME/TC SET] key.**
The display now shows the TC SETUP menu screen.

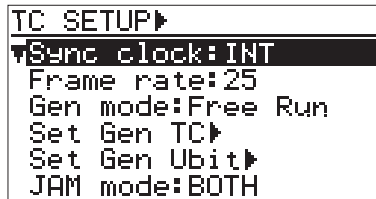

- 2) **Use the [MENU] dial to select the "Frame Rate" menu item, and press the [ENTER/YES] key.**
The current setting starts flashing and you can now select the desired option.

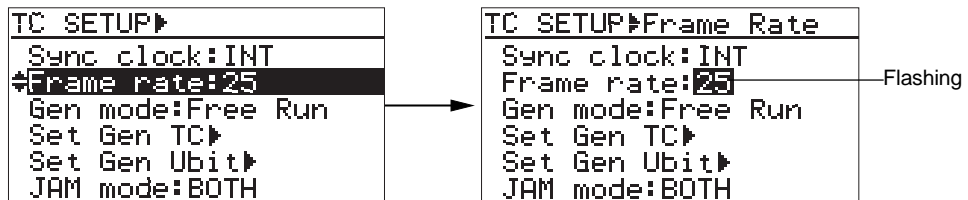

- 3) **Use the [MENU] dial to select the desired option, and press the [ENTER/YES] key to confirm your setting.**

Options	
You can select from among "23.97", "24", "25", "29.97", "29.97DF", "30" and "30DF" (the default is "25").	
23.97	23.976FPS, Film -0.1%
24	24FPS, Film
25	25FPS, European PAL-SECAM video
29.97	29.97FPS, NTSC color
29.97DF	29.97FPS, NTSC color with real time adjust
30	30FPS, NTSC video
30DF	30FPS, NTSC video

- 4) **Press the [EXIT] key repeatedly until you exit the MENU mode.**

Generator mode selection [Gen mode]

Using the "Gen mode" menu item, you can select the generator mode of the internal TC generator. You can also select the generator mode using the quick setup mode.

- 1) **When the unit is stopped, press the [SHIFT] key to light the [SHIFT] indicator, followed by the [TIME/TC SET] key.**

The display now shows the TC SETUP menu screen.

```

TC SETUP▶
▼Sync clock:INT
Frame rate:25
Gen mode:Free Run
Set Gen TC▶
Set Gen Ubit▶
JAM mode:BOTH
  
```

- 2) **Use the [MENU] dial to select the "Gen mode" menu item, and press the [ENTER/YES] key.** The current setting starts flashing and you can now select the desired option.

<pre> TC SETUP▶ Sync clock:INT Frame rate:25 ▶Gen mode:Rec Run Set Gen TC▶ Set Gen Ubit▶ JAM mode:BOTH </pre>	→	<pre> TC SETUP▶Gen mode Sync clock:INT Frame rate:25 Gen mode:Rec Run Set Gen TC▶ Set Gen Ubit▶ JAM mode:BOTH </pre>	Flashing
---	---	--	----------

- 3) **Use the [MENU] dial to select the desired option, and press the [ENTER/YES] key to confirm your setting.**

Options	
You can select from among "Rec Run", "Ext Run", "Free Run" and "24H Run" (the default is "Rec Run").	
Rec Run	When recording, the unit records time code which continues from the last time code value of the previous audio file. If you change to a new disk which does not have any audio file and make recording, the unit records time code which continues from the last time code value of the most recent audio file on the disk previously set.
Ext Run	When recording, the unit records the incoming external time code. If the unit does not receive external time code, the unit always records the Default LTC start time at the beginning of the file.
Free Run	When recording, the unit records time code generated by the internal generator which runs freely.
24H Run	When recording, the unit records time code based on the current internal RTC (real-time clock) time.

- 4) **Press the [EXIT] key repeatedly until you exit the MENU mode.**

Internal TC generator setting [Set Gen TC]

Using the "Set Gen TC" menu item, you can check the time code value of the internal time code generator, as well as can edit the time code start time for the "FREE RUN" or "REC RUN" mode.

If you make recording to multiple disks (or partitions) successively in "Rec Run" mode, by setting the time code value to the last LTC time when changing the disk (or partition), you can stripe continuous LTC to the multiple disks (or partitions).

- 1) **When the unit is stopped, press the [SHIFT] key to light the [SHIFT] indicator, followed by the [TIME/TC SET] key.**

The display now shows the TC SETUP menu screen.

```

TC SETUP▶
▼Sync clock:INT
Frame rate:25
Gen mode:Free Run
Set Gen TC▶
Set Gen Ubit▶
JAM mode:BOTH
    
```

- 2) **Use the [MENU] dial to select the "Set Gen TC" menu item, and press the [ENTER/YES] key.**

The display shows the "Set Gen TC" screen, on which you can see the current internal time code generator setting information (generator mode and TC start time).

(When the generator mode is set to "Rec Run", time code value field is shown as "--h--m--s--f".)

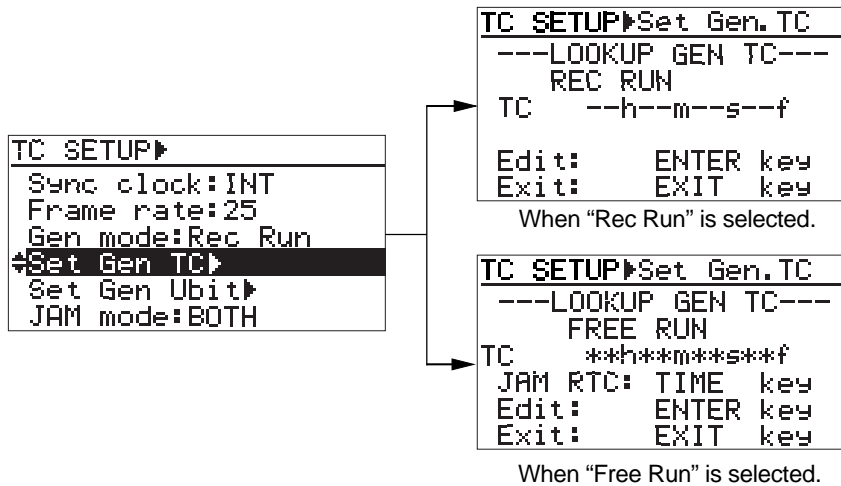

<Note>: If no time code is fed to the unit in the "EXT RUN" mode, "<<No EXT TC!>>" is shown.

Time code starting value "--h --m --s --f":
 If you record the next file in the "Rec Run" mode while "--h --m --s --f" is shown, the PD204 stripes a time code which continues after the previous file. However, if you start recording when "No File" is shown (i.e. no file is recorded on the current DVD-RAM disk or hard disk partition), the PD204 stripes time code from "default LTC start time".
 If you make next recording, the PD204 stripes a time code which continues after the previous file. You can edit the time code starting value to a desired value if necessary.

If you just check the information on the screen, press the [EXIT] key repeatedly until exiting the TC SETUP menu. To edit the time code start time when the generator mode is set to "Free Run" or "Rec Run", follow the description below.

• **Editing the time code value in Rec run mode:**

When the "Set Gen TC" primary screen is shown, press the [ENTER/YES] key. The time code value at the record end of the last file currently loaded is shown and you can edit this value.

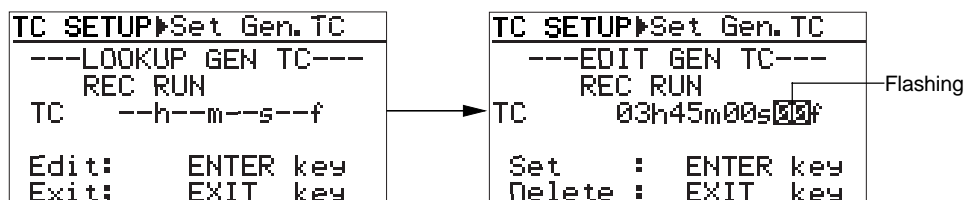

If you want to start the next file from this time code value, simply press the [ENTER/YES] key. If you want to start the next file from a desired time code value, edit the time code value and press the [ENTER/YES] key.

<How to edit a value>: Use the [◀◀] / [▶▶] keys to move the edit position between the time digits and use the [MENU] dial (or the alphanumeric keys) to enter a desired value.

After editing the start time code value (or without editing the value), pressing the [ENTER/YES] key sets the time code value and display returns to the "Set Gen. TC" primary screen. (In the following example, no time code editing is made.)

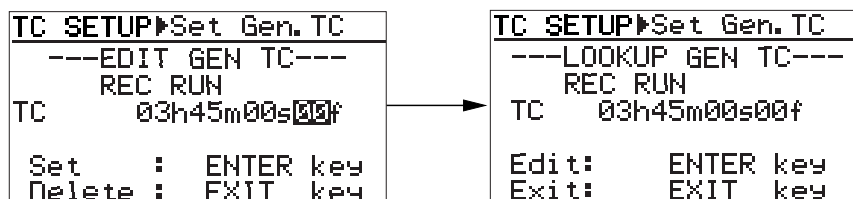

<How to reset the edited time code value to the initial condition>

To reset the specified time code value to "--H--M--S--F", press the [ENTER/YES] key followed by the [EXIT] key while the "Set Gen. TC" primary screen (as shown on the right above) is shown. The specified time code is reset to "--H--M--S--F".

<Note>: If you turn off the power after setting the TC starting value, the value is reset to "--H--M--S--F".

• **Editing the time code value in Free run mode:**

When the "Set Gen TC" primary screen is shown, press the [ENTER/YES] key. The time code value at the record end of the last file currently loaded is shown and you can edit this value.

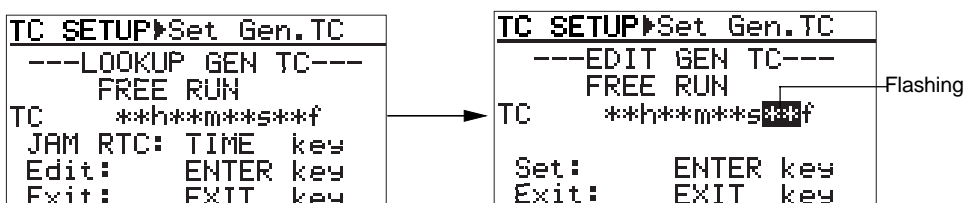

In the similar manner to editing the time code value in Rec run mode, edit the time value and press the [ENTER/YES] key to confirm.

• **Jamming the time code value in Free run mode:**

If you press the [TIME] key while the editing screen (the "Set Gen TC" screen where an editing point is flashing) is shown, the LTC start time is jammed to the internal realtime clock data.

- 3) Press the [EXIT] key repeatedly until you exit the MENU mode.

User bit setting [Set Gen Ubit]

You can set the time code user bit and user bit mode of the time code which is output from the [TIME CODE OUT] connector when the "Sel TC Out" item is set to "Gen".

- 1) When the unit is stopped, press the [SHIFT] key to light the [SHIFT] indicator, followed by the [TIME/TC SET] key.

The display now shows the TC SETUP menu screen.

```
TC SETUP▶
  Sync clock:INT
  Frame rate:25
  Gen mode:Free Run
  Set Gen TC▶
  Set Gen Ubit▶
  JAM mode:BOTH
```

- 2) Use the [MENU] dial to select the "Set Gen Ubit" menu item, and press the [ENTER/YES] key.

The display now shows the "Set Gen Ubit" screen on which you can set the user bit mode and the user bit value.

```
TC SETUP▶
  Set Gen TC▶
  Set Gen Ubit▶
  JAM mode:BOTH
  Sel.TC out:Repro
  Default LTC start▶
  Edit LTC start▶
```

```
TC SETUP▶Set Gen Ubit
  Ubit MD: uuuuuuuu
  User: 00 00 00 00
  Ubit:[00 00 00 00]
  Select: MENU dial
  Edit: ENTER key
  Exit: EXIT key
```

Shows the current user bit. You can set the desired user bit. The rightmost two figures of the user bit are always used regardless of the "Ubit MD" setting.

```
TC SETUP▶Set Gen Ubit
  Ubit MD: uuuuuuuu
  User: 00 00 00 00
  Ubit:[00 00 00 00]
  Select: MENU dial
  Edit: ENTER key
  Exit: EXIT key
```

Sets the user bit mode. See the table below for details about the available options. The default is "uuuuuuu", which is set to "00 00 00 00" by default.

Shows the user bit being output according to the current user bit mode. If you change the user bit mode.

Selecting the user bit mode

By pressing the [ENTER/YES] key while "Ubit MD: uuuuuuuu" is highlighted, the current user bit mode starts flashing and you can now select the mode (by default, "uuuuuuuu" flashes).

```
TC SETUP▶Set Gen Ubit
  Ubit MD: uuuuuuuu
  User: 00 00 00 00
  Ubit:[00 00 00 00]
  Select: MENU dial
  Edit: ENTER key
  Exit: EXIT key
```

```
TC SETUP▶Set Gen Ubit
  Ubit MD: uuuuuuuu
  User: 00 00 00 00
  Ubit:[00 00 00 00]
  Select: MENU dial
  Edit: ENTER key
  Exit: EXIT key
```

Flashing

Use the [MENU] dial to select the user bit mode and press the [ENTER/YES] key to confirm your selection. You can select from among the following.

Options	
You can select from among “uuuuuuuu”, “MMDDYYuu” and “DDMMYYuu” (the default is “uuuuuuuu”).	
uuuuuuuu	The default is “00 00 00 00”.
MMDDYYuu	BG_76: MM (month)/BG_54: DD (day)/BG_32: YY (year)/BG_10: uu (for USA)
DDMMYYuu	BG_76: DD (day)/BG_54: MM (month)/BG_32: YY (year)/BG_10: uu (for EUR)

When selecting “MMDDYYuu” or “DDMMYYuu”, you can set the desired user bit to “uu” of “BG_10: uu”. The other fields are automatically set to the date of the realtime clock.

Editing the user bit

By using the [MENU] dial to highlight “User: 00 00 00 00” and pressing the [ENTER/YES] key, the rightmost field of the current user bit (by default, “0”) starts flashing and you can now make editing.

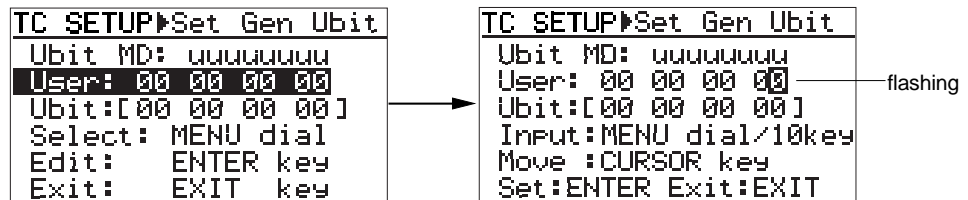

You can enter the desired value to the flashing field using the numeric keys or the [MENU] dial. You can move the flashing field using the [◀◀] / [▶▶] keys.

- 3) Press the [ENTER/YES] key to confirm your setting.
- 4) Press the [EXIT] key repeatedly until you exit the MENU mode.

Jam mode setting [JAM mode]

Using the "JAM mode" menu item, you can select the jam mode for the generator "Free Run" mode (You can set which information is jammed).

- 1) When the unit is stopped, press the [SHIFT] key to light the [SHIFT] indicator, followed by the [TIME/TC SET] key.

The display now shows the TC SETUP menu screen.

```

TC SETUP▶
▼Sync clock:INT
Frame rate:25
Gen mode:Free Run
Set Gen TC▶
Set Gen Ubit▶
JAM mode:BOTB
    
```

- 2) Use the [MENU] dial to select the "JAM mode" menu item, and press the [ENTER/YES] key. The current setting starts flashing and you can now select the desired option.

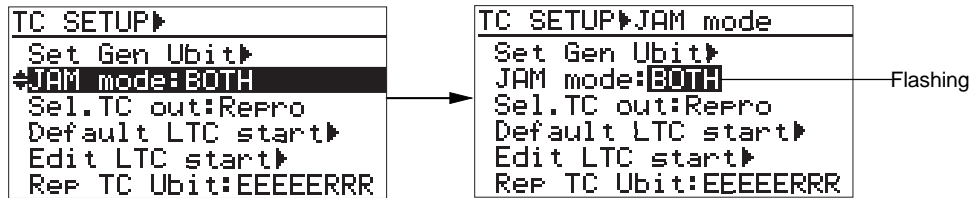

- 3) Use the [MENU] dial to select the desired option, and press the [ENTER/YES] key to confirm your setting.

Options	
You can select from among "BOTH", "TC" and "UBIT" (the default is "BOTH").	
BOTH	Both time code and userbit data are jammed.
TC	Only time code data is jammed. For userbit, the userbit data of the internal generator is used.
UBIT	Only the userbit data is jammed. For time code, the time code data of the internal generator is used.

- 4) Press the [EXIT] key repeatedly until you exit the MENU mode.

Time code output source selection [Sel. TC Out]

Using the "Sel. TC Out" menu item, you can set the time code source (Repro or Gen) fed from the [TIME CODE OUT] connector.

- 1) When the unit is stopped, press the [SHIFT] key to light the [SHIFT] indicator, followed by the [TIME/TC SET] key.

The display now shows the TC SETUP menu screen.

```

TC SETUP▶
▼Sync clock:INT
Frame rate:25
Gen mode:Free Run
Set Gen TC▶
Set Gen Ubit▶
JAM mode:BOTH
  
```

- 2) Use the [MENU] dial to select the "Sel. TC Out" menu item, and press the [ENTER/YES] key. The current setting starts flashing and you can now select the desired option.

```

TC SETUP▶
Set Gen.TC▶
Set Gen Ubit▶
JAM mode:BOTH
▼Sel. TC out:Repro
Default LTC start▶
Edit LTC start▶
          
```

→

```

TC SETUP▶Sel. TC Out
Set Gen.TC▶
Set Gen Ubit▶
JAM mode:BOTH
Sel. TC out:Repro
Default LTC start▶
Edit LTC start▶
          
```

Flashing

- 3) Use the [MENU] dial to select the desired option, and press the [ENTER/YES] key to confirm your setting.

Options	
You can select from among "Repro" and "Gen" (the default is "Repro").	
Repro	Outputs playback time code.
Gen	Outputs the internal generator time code.

<Note>: Even if "Sel. TC Out" is set to "Gen", the generator time code is not output when the generator mode is set to the "EXT RUN" mode.

- 4) Press the [EXIT] key repeatedly until you exit the MENU mode.

Default LTC start time setting [Default LTC start]

Using the "Default LTC start" menu item, you can set the desired default LTC start time value (the initial setting is "1h 00m 00s"). This value is used when the generator mode is set to "Ext Run" but no external time code is fed to the unit.

<Note>: The unit does not recognize paused time code as "correct" time code. It recognizes time code when receiving more than two continuous frames.

- 1) **When the unit is stopped, press the [SHIFT] key to light the [SHIFT] indicator, followed by the [TIME/TC SET] key.**

The display now shows the TC SETUP menu screen.

```

TC SETUP▶
▼Sync clock:INT
Frame rate:25
Gen mode:Free Run
Set Gen TC▶
Set Gen Ubit▶
JAM mode:BOTH
    
```

- 2) **Use the [MENU] dial to select the "Default LTC start" menu item, and press the [ENTER/YES] key.**
- The current LTC start time is shown (initially, "01h 00m 00s" is shown).

<pre> TC SETUP▶ Set Gen Ubit▶ JAM mode:BOTH Sel.TC out:Repro ▼Default LTC start▶ Edit LTC start▶ Rep TC Ubit:EEEEERRR </pre>	→	<pre> TC SETUP▶Default TC --LOOKUP DEFAULT TC-- 01h00m00s Edit: ENTER Key Exit: EXIT Key </pre>
--	---	---

- 3) **Press the [ENTER/YES] key again.**

The second value flashes and you can now edit the default LTC start time.

<pre> TC SETUP▶Default TC --LOOKUP DEFAULT TC-- 01h00m00s Edit: ENTER Key Exit: EXIT Key </pre>	→	<pre> TC SETUP▶Default TC ---EDIT DEFAULT TC--- 01h00m00s Rewrite: ENTER Key Exit: EXIT Key </pre>
---	---	---

Flashing

- 4) **Edit the time value to the desired value, and press the [ENTER/YES] key to confirm your setting.**

Use the [MENU] dial (or the alphanumeric keys) to enter a desired value and use the [◀◀] / [▶▶] keys to move the cursor position. The setting is stored to the Flash ROM of the unit.

- 5) **Press the [EXIT] key repeatedly until you exit the MENU mode.**

LTC start time editing [Edit LTC start]

Using the "Edit LTC start" menu item, you can set the desired LTC start time of a playback audio file. The LTC start time is recorded to the currently load file.

<Note>: The PD204 records only the start time of LTC, and the internal generator generates and outputs LTC with reference to the start time.
On a "BWF" file, the start time is recorded as "Time Reference" in "Broadcast Audio Extension Chunk". Therefore, if you want to use this LTC in Digidesign Pro Tools, export the audio file to Pro Tools and make "User Time Code" effective.

- 1) When the unit is stopped, press the [SHIFT] key to light the [SHIFT] indicator, followed by the [TIME/TC SET] key.

The display now shows the TC SETUP menu screen.

```
TC SETUP▶
▼Sync clock:INT
Frame rate:25
Gen mode:Free Run
Set Gen TC▶
Set Gen Ubit▶
JAM mode:BOTH
```

- 2) Use the [MENU] dial to select the "Edit LTC start" menu item, and press the [ENTER/YES] key. The LTC start time recorded on the current file is shown.

<pre>TC SETUP▶ Default LTC start▶ ▼Edit LTC start▶ Rep TC Ubit:EEEEERRR Rep pause TC:Off RecIn via ExtTc:Off TC PWR Timer: 5min</pre>	→	<pre>TC SETUP▶LTC Start --LOOKUP LTC START-- **h**m**s**f**sf Edit: ENTER key Exit: EXIT key</pre>
---	---	--

- 3) Press the [ENTER/YES] key again. Initially, the subframe value flashes and you can now edit the LTC start time.

<pre>TC SETUP▶LTC Start --LOOKUP LTC START-- **h**m**s**f**sf Edit: ENTER key Exit: EXIT key</pre>	→	<pre>TC SETUP▶LTC Start ---EDIT LTC START--- **h**m**s**f**sf Rewrite: ENTER key Exit: EXIT key</pre>	Flashing
--	---	--	----------

- 4) After editing the start time, press the [ENTER/YES] key to confirm your setting. Use the [MENU] dial (or the alphanumeric keys) to enter a desired value and use the [←←] / [→→] keys to move the cursor position.

- 5) Press the [EXIT] key repeatedly until you exit the MENU mode.

UBIT setting of playback time code [RepTC Ubit]

Using the "RepTC Ubit" menu item, you can select the desired userbit of time code which is output from the [TIME CODE OUT] connector while the "Sel TC Out" is set to "Repro".

- 1) When the unit is stopped, press the [SHIFT] key to light the [SHIFT] indicator, followed by the [TIME/TC SET] key.

The display now shows the TC SETUP menu screen.

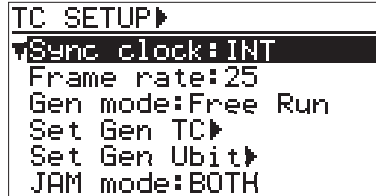

- 2) Use the [MENU] dial to select the "Rep TC Ubit" menu item, and press the [ENTER/YES] key.

The currently selected time code userbit flashes (the default is "EEEEERRR"). You can now select the userbit.

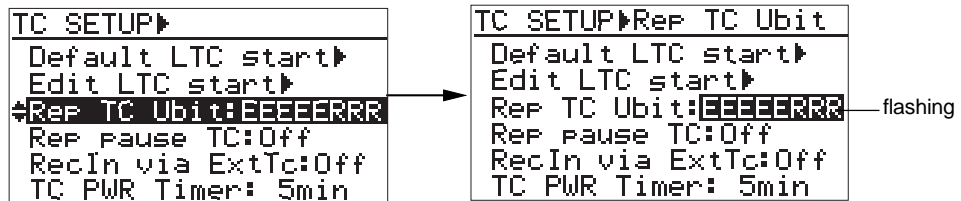

- 3) Use the [MENU] dial to select the desired TC userbit, and press the [ENTER/YES] key to confirm your selection.

EEEEERRR	BG_76543: EEEEE / BG_210: RRR (default setting)
MMDDYYff	BG_76: MM (month)/BG_54: DD (day)/BG_32:YY (year)/BG_10: ff (US)
DDMMYYff	BG_76: DD (day)/BG_54: MM (month)/BG_32:YY (year)/BG_10: ff (EUR)
SSSSSSRR	BG_756432: SSSSSS / BG_10: RR
RRREEEEE	BG_756: RRR / BG_54321: EEEEE
SSSSSSTT	BG_756432: SSSSSS / BG_01: TT
<BWF UBIT>	Outputs the userbit in the BWF descriptor information.
EEEE:EVENT No:	Only the lower five figures of the numeral information in the event information recorded on BWF are output from the rightmost five digits of the user bit fields.
RRR:REEL No:	Only the lower three figures of the reel number recorded on BWF are output from the rightmost three digits of the user bit fields.
RR:REEL No:	Only the lower two figures of the reel number recorded on BWF are output from the rightmost two digits of the user bit fields.
SSSSSS:SCENE No:	Only the lower six figures of the scene number recorded on BWF are output from the rightmost six digits of the user bit fields.
TT:Take No:	Only the lower two figures of the take number recorded on BWF are output from the rightmost two digits of the user bit fields.
ff:	File No (in decimal, 01 to 99)
<p><Note>: Date information (year, month and day) shows the original date of an audio file. The event number, reel number, scene number, and take number must be set using the appropriate menu items in advance.</p>	

- 4) Press the [EXIT] key repeatedly until you exit the MENU mode.

Time code output while paused [Rep pause TC]

Using the "Rep pause TC" menu item, you can select whether time code is output from the [TIME CODE OUT] connector or not while the recorder is paused.

- 1) When the unit is stopped, press the [SHIFT] key to light the [SHIFT] indicator, followed by the [TIME/TC SET] key.

The display now shows the TC SETUP menu screen.

```

TC SETUP▶
▼Sync clock:INT
Frame rate:25
Gen mode:Free Run
Set Gen TC▶
Set Gen Ubit▶
JAM mode:BOTH
  
```

- 2) Use the [MENU] dial to select the "Rep pause TC" menu item, and press the [ENTER/YES] key. The current setting starts flashing and you can now select "On" or "Off".

<pre style="margin: 0;"> TC SETUP▶ Default LTC start▶ Edit LTC start▶ Rep TC Ubit:EEEEERRR *Rep pause TC:Off RecIn via ExtTc:Off TC PWR Timer: 5min </pre>	→	<pre style="margin: 0;"> TC SETUP▶Rep pause TC Default LTC start▶ Edit LTC start▶ Rep TC Ubit:EEEEERRR Rep pause TC:Off RecIn via ExtTc:Off TC PWR Timer: 5min </pre>	Flashing
--	---	---	----------

- 3) Use the [MENU] dial to select the desired option, and press the [ENTER/YES] key to confirm your selection.

Options	
You can select from among "On" and "Off" (the default is "Off").	
On	When the "Sel TC Out" menu item is set to "Repro" and the unit is stopped (or paused), a paused time code value (same time code value) is output intermittently.
Off	When the "Sel TC Out" menu item is set to "Repro" and the unit is stopped (or paused), no time code is output.

- 4) Press the [EXIT] key repeatedly until you exit the MENU mode.

Automatic recording start by external TC [Recin via ExtTC]

Using the "Recin via ExtTC" item, you can select whether or not the unit automatically starts recording when it receives external time code.

By setting this item to "On" (the default is "Off") and setting the "Gen mode" item in the "TC SETUP" mode to "Ext Run (External Run)", the unit automatically starts recording when the unit receives external time code whose frame rate matches the frame rate setting of the PD204.

<Note>: In order to start recording automatically when the unit receives time code, the frame rate setting of the unit match the external time code frame rate. Before you attempt to make recording, make sure that the both frame rates are the same.

- 1) When the unit is stopped, press the [SHIFT] key to light the [SHIFT] indicator, followed by the [TIME/TC SET] key.

The display now shows the TC SETUP menu screen.

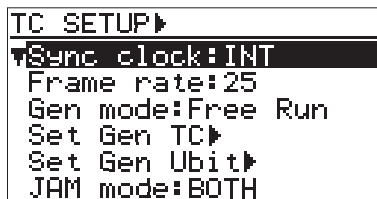

- 2) Use the [MENU] dial to select the "Recin via ExtTC" menu item, and press the [ENTER/YES] key. The current setting starts flashing and you can now select "On" or "Off".

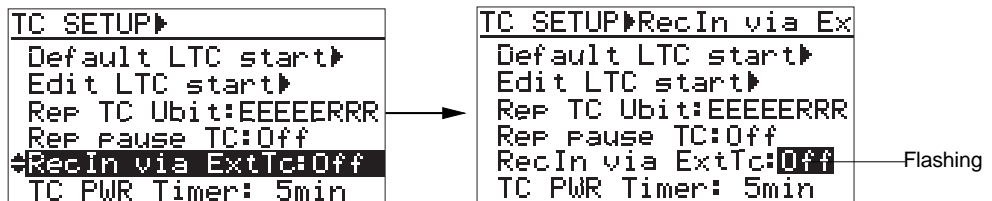

- 3) Use the [MENU] dial to select the desired option, and press the [ENTER/YES] key to confirm your setting.

Options	
You can select from among "On" and "Off" (the default is "Off").	
On	When the unit receives external time code whose frame rate matches the frame setting of the unit, the unit automatically starts recording.
Off	When the unit receives external time code whose frame rate matches the frame setting of the unit, the unit does not automatically start recording.

- 4) Press the [EXIT] key repeatedly until you exit the MENU mode.

Internal TC generator power-off timer [TC PWR Timer]

Using the "TC PWR Time" item, you can set the time until the TC generator turns off after turning off the main unit.

It is set to five minutes by default, so after the PD204 is turned off, the internal TC generator continues working for five more minutes.

- 1) **When the unit is stopped, press the [SHIFT] key to light the [SHIFT] indicator, followed by the [TIME/TC SET] key.**

The display now shows the TC SETUP menu screen.

```

TC SETUP▶
▼ Sync clock:INT
Frame rate:25
Gen mode:Free Run
Set Gen TC▶
Set Gen Ubit▶
JAM mode:BOTH
  
```

- 2) **Use the [MENU] dial to select the "Recln via ExtTC" menu item, and press the [ENTER/YES] key.** The current setting starts flashing and you can now select the desired option.

```

TC SETUP▶
Default LTC start▶
Edit LTC start▶
Rep TC Ubit:EEEEERRR
Rep pause TC:Off
Recln via ExtTc:Off
▲TC PWR Timer: 5min
          
```

→

```

TC SETUP▶TC PWR Timer
Default LTC start▶
Edit LTC start▶
Rep TC Ubit:EEEEERRR
Rep pause TC:Off
Recln via ExtTc:Off
TC PWR Timer: 5min
          
```

Flashing

- 3) **Use the [MENU] dial to select the desired option, and press the [ENTER/YES] key to confirm your setting.**

Options
You can select from among "0min", "5min", "10min", "15min", "30min", "1hour", "2hour", "4hour", "8hour" and "Cont." (Continue) (the default is "5min").

<Note>: When any option except "0min" is selected, the display backlight flashes weakly and slowly after turning off the PD204, indicating that the internal TC generator is still working. We recommend selecting shorter time for the "TC PWR Timer" item when operating the unit on battery.

- 4) **Press the [EXIT] key repeatedly until you exit the MENU mode.**

DISK UTILITY menu

In the DISK UTILITY menu, 12 menu items for settings regarding recording media and recorded audio files are available. This section explains the following ten menu items in the table below. For the "File copy" and "Disk copy" menu items in the DISK UTILITY menu, see pages shown below.

Menu item	Setting/function
Edit file name	Edits the audio file name.
File info.	Displays audio file information and edits descriptor information.
Delete file	Deletes an unnecessary file.
Restore Del. file	Restores a deleted file.
Format	Formats a DVD-RAM disk or a partition of the internal hard disk drive.
Reel No	Edits a reel No. (volume label) of an audio file.
Rec protect	Selects on/off of the record protection of an audio file.
Resume	Selects on/off of the resume function of an audio file.
Part. protect	Selects on/off of the record protection of a partition of the internal hard disk drive.
* File copy	See page 110 for details.
* Disk copy	See page 107 for details.
HDD Ope. Time	Shows the operating time of the internal hard disk drive.

Editing a file name [Edit file name]

The "Edit file name" menu item edits a file name of the currently loaded audio file.

- 1) While the unit is stopped, press the [SHIFT] key to light the [SHIFT] indicator, followed by the [ENTER/YES] key.

The unit enters the MENU mode and the MENU list screen is shown.

- 2) Use the [MENU] dial to select the "DISK UTILITY" menu and press the [ENTER/YES] key. The display now shows the DISK UTILITY menu screen.

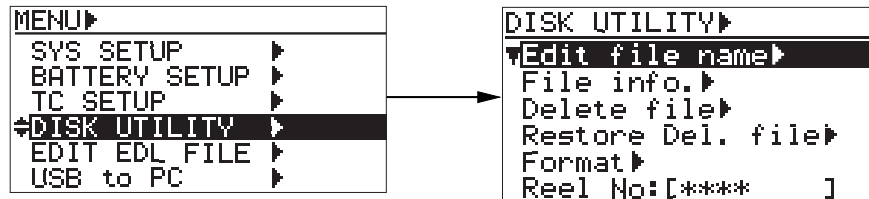

- 3) While "Edit file name" is highlighted, press the [ENTER/YES] key.

The display now shows the "EDIT FILE NAME" screen. On this screen, you can edit the current file name (the rightmost character of the name flashes).

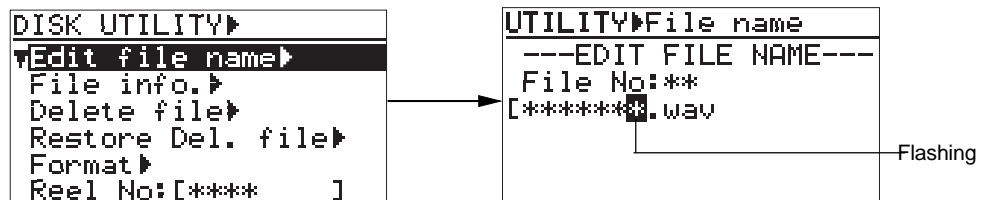

- 4) Enter the desired name.

Use the [◀◀] / [▶▶] keys to move the cursor position and use the [MENU] dial (or the alphanumeric keys) to enter a desired character.

By pressing the [CLEAR] key repeatedly when the cursor is pointing the leftmost character, you can clear the whole name.

<Note>: ".wav", the file extension, is automatically added, therefore, you do not need to enter it.

- 5) After entering the name, press the [ENTER/YES] key to confirm your setting.

The unit exits the MENU mode and the display shows the Home screen.

<Note>: If you enter a file name which already exists and press the [ENTER/YES] key, "Illegal Name!" is shown and the display returns to show the previous screen before editing.

Viewing a file information and editing descriptor information [File info.]

Using the "File info." menu item, you can view audio file information, as well as edit the descriptor information and iXML information. You can check the following file information.

- 1) File name of the audio file
- 2) Descriptor information (BWF Sound Sequence information)
- 3) iXML Chunk data information
- 4) File creation date and time (year/month/day/hour/minute/second)
- 5) LTC start time information (LTC time at the beginning of recording)
- 6) LTC end time information (LTC time at the end of recording)
- 7) Duration information (of audio area, shown in time code)
- 8) File occupying space

- 1) While the unit is stopped, press the [SHIFT] key to light the [SHIFT] indicator, followed by the [ENTER/YES] key.
The unit enters the MENU mode and the MENU list screen is shown.
- 2) Use the [MENU] dial to select the "DISK UTILITY" menu and press the [ENTER/YES] key.
The display now shows the DISK UTILITY menu screen.

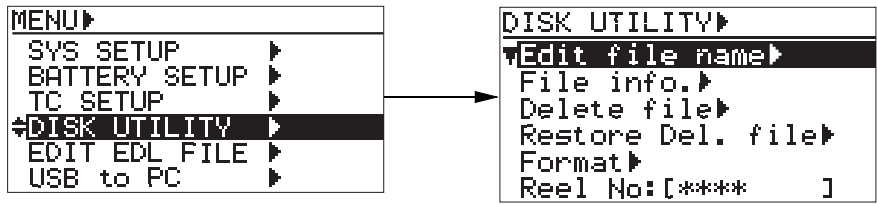

- 3) Use the [MENU] dial to select the "File Info." menu item and press the [ENTER/YES] key.
The display changes to show the "Edit descriptor" screen, on which you can view the current file information. You can view the descriptor information on the next level screen, while the other items are shown on this screen. You can scroll the screen by rotating the [MENU] dial.

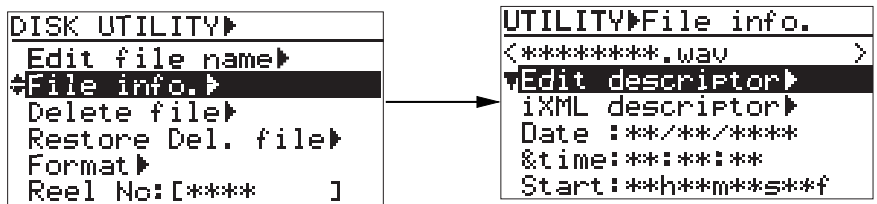

- 4) While "Edit descriptor" is highlighted, press the [ENTER/YES] key.
The display goes down to the next level screen of "Edit descriptor" and shows the BWF sound sequence information. You can view and edit the recording area (up to 265 characters of the description area specified by the BWF standard) for the sound sequence information of a BWF file.

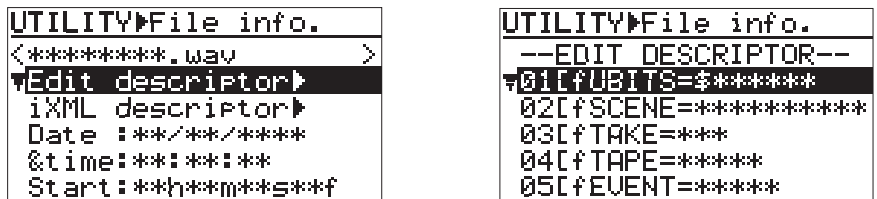

- 5) **By rotating the [MENU] dial, the sound sequence information is scrolled.**
See the next page for details about the sound sequence information.

The sound sequence information of a BWF file includes items as below and you can edit them if necessary. "<New line>" at the bottom is used for adding a new descriptor information. See "Adding descriptor information" for details.

```

UTILITY▶File info.
--EDIT DESCRIPTOR--
01[fUBITS=$*****
02[fSCENE=*****
03[fTAKE=***
04[fTAPE=*****
05[fEVENT=*****
06[fSPEED=*****
07[fTRK1=*****
08[fTRK2=*****
09[fNOTE=
10[<New line>

```

The table below shows the details of the descriptor information which Fostex registers by default, as shown on the screen example above. The information can be used for creating an AVID ALE file, as well as can be directly exported to the AVID system via USB (or via a disk).

<Note>: Each character string before "=" shows the "header ID" of currently available meta data.

Line No.	Contents	Details
01	fUBITS=\$	The user bit used when recording time code is recorded by default.
02	fSCENE=*****	When creating a file, the character string before "-" in the file name is set as a SCENE by default.
03	fTAKE=***	When creating a file, the three-digit number between "-" and the file extension in the file name is set as a TAKE number by default.
04	fTAPE=*****	When creating a file, the reel number (volume label) on the disk is set as a TAPE number (up to 8 digits) by default.
05	fEVENT=*****	The five-digit number set by the "Set Next Event" menu item in the "System Setup" menu of the MENU mode is set as an EVENT number by default.
06	fSPEED=*****	The frame rate set by the "Frame rate" menu item in the "System Setup" menu of the MENU mode is set as the frame rate by default.
07	fTRK1=*****	Track name of each track. A default track name (up to 16 characters) for each track is recorded.
08	fTRK2=*****	
09	fNOTE=	This is used for comment. By default, no data exists.

Editing descriptor information:

- 1) Use the [MENU] dial to select a desired descriptor information item and press the [ENTER/YES] key.
The first character of the selected descriptor information item flashes and you can now edit the item.

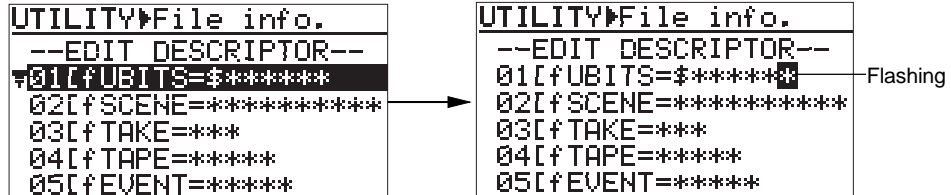

- 2) Use the [←←] / [→→] key to move the cursor position to the right of "=" and make editing.
- 3) Use the [MENU] dial (or the alphanumeric keys) to enter characters.

While the cursor is on the first character of the descriptor information, pressing the [CLEAR] key repeatedly clears all the information.

- 4) After editing the information item, press the [ENTER/YES] key to confirm your setting.
- 5) To edit another descriptor information item, carry out the same procedure as above repeatedly.

Adding descriptor information:

You can add a new descriptor information item to the current information.

- 1) Select "<New line>" at the bottom and press the [ENTER/YES] key.
You are now ready for entering a new item.
Carry out the same procedure as above for entering a new item.

<Note>: When adding a new descriptor information item, always enter the "meta data header ID", followed by data.

- 2) After entering new information, press the [ENTER/YES] key to confirm your setting.

Deleting descriptor information:

Unused descriptor information can be deleted.

- 1) Select a line you want to delete, and press the [ENTER/YES] key.
You can now edit the line, as described above.
- 2) Press the [CLEAR] key repeatedly to clear the whole information, and press the [ENTER/YES] key.
The line is deleted, while the subsequent lines move up.

• Viewing iXML Chunk data information

You can view and edit iXML Chunk data via the "iXML descriptor" item.

- 1) **Select "iXML descriptor" and press the [ENTER/YES] key.**
The display now shows the iXML descriptor information.

```

UTILITY▶File info.
<*****.wav >
Edit descriptor▶
iXML descriptor▶
Date : **/**/****
&time: **:**:
Start: **h**m**s**f
  
```

```

UTILITY▶File info.
--iXML DESCRIPTOR--
<ixml version="1.0"
encoding="UTF-8"?>↓
<BWFXML>↓
<PROJECT></PROJECT>↓
<SCENE>SCENE</SCENE>↓
  
```

- 2) **Rotate the [MENU] dial to scroll the iXML Chunk data.**

• Editing iXML Chunk data information

You can edit any desired iXML Chunk data.

- 1) **Use the [MENU] dial to select the line of the desired data and press the [ENTER/YES] key.**
The leftmost character flashes and you can now make editing.

```

UTILITY▶File info.
--iXML DESCRIPTOR--
<ixml version="1.0"
encoding="UTF-8"?>↓
<BWFXML>↓
<PROJECT></PROJECT>↓
<SCENE>SCENE</SCENE>↓
  
```

```

UTILITY▶File info.
--iXML DESCRIPTOR--
<ixml version="1.0"
encoding="UTF-8"?>↓
<BWFXML>↓
<PROJECT></PROJECT>↓
<SCENE>SCENE</SCENE>↓
  
```

- 2) **Use the alphanumeric keys or [MENU] dial to enter the desired information.**
You can move the editing point (cursor point) using the [◀◀] / [▶▶] keys. By pressing the [Enter] key of the USB keyboard, "down" is added at the end of the current line and a new line begins.
- 3) **After you complete editing, press the [ESC] or [HOME] key of the USB keyboard or the [STOP] key of the PD204.**
The popup for confirmation as below appear on the display. Pressing the [ENTER/YES] key updates iXML Chunk data to the edited data. Pressing the [EXIT] key cancels editing.

```

Changed iXML data
Are you sure?
Yes:ENTER No:EXIT
  
```

<Note>: After updating the iXML Chunk data, the display returns to the Home screen by pressing the [STOP] of the unit or the [HOME] key of the USB keyboard.

Deleting an unnecessary audio file [Delete file]

The “Delete file” menu item deletes an unnecessary audio file. You can delete only the currently loaded audio file, therefore, you must load the desired audio file before deleting it.

<Note>: A deleted file is not completely deleted from the disk. It still exists as a "hidden file". You can restore a hidden file by the "Restore Del File" menu item described later.

- 1) **While the unit is stopped, press the [SHIFT] key to light the [SHIFT] indicator, followed by the [ENTER/YES] key.**
The unit enters the MENU mode and the MENU list screen is shown.

- 2) **Use the [MENU] dial to select the “DISK UTILITY” menu and press the [ENTER/YES] key.**
The display now shows the DISK UTILITY menu screen.

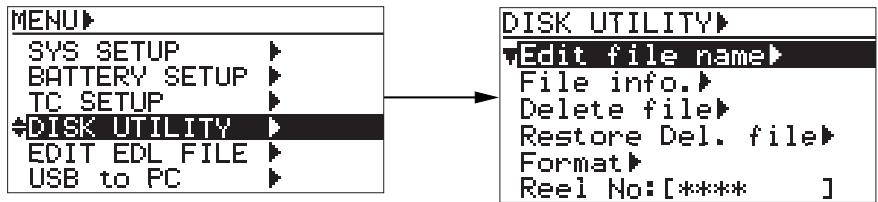

- 3) **Use the [MENU] dial to select the "Delete file" menu item and press the [ENTER/YES] key.**
The display goes down to the "DELETE FILE" screen, on which the current file number and file name are shown, while "Sure?" flashes.

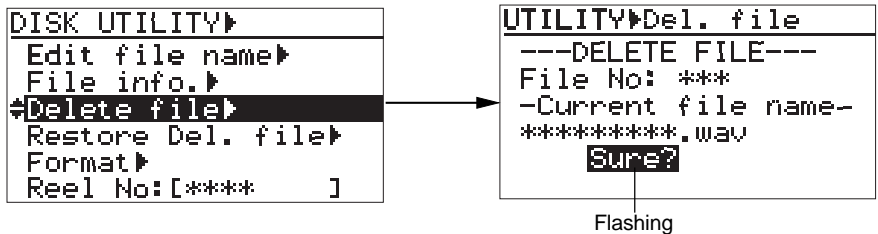

<Note>: To cancel deleting a file, press the [EXIT] key while "Sure?" is flashing. You cannot cancel the operation after starting deleting.

- 4) **Press the [ENTER/YES] key again.**
The unit starts deleting the current audio file. While executing deleting, "Please wait!" is flashing on the display.

When the delete operation is completed, "Completed!" appears on the display and the unit automatically exits the MENU mode.

Restoring a deleted audio file [Restore Del. file]

Using the "Restore Del. file" menu item, you can restore a hidden file which is deleted by the "Delete file" menu.

<Note>: A file deleted by computer operation cannot be restored.

- 1) While the unit is stopped, press the [SHIFT] key to light the [SHIFT] indicator, followed by the [ENTER/YES] key.

The unit enters the MENU mode and the MENU list screen is shown.

- 2) Use the [MENU] dial to select the "DISK UTILITY" menu and press the [ENTER/YES] key.

The display now shows the DISK UTILITY menu screen.

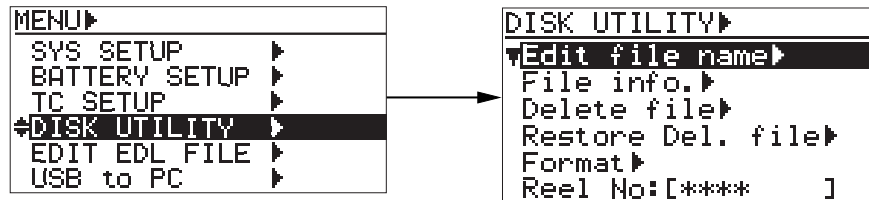

- 3) Use the [MENU] dial to select the "Restore Del. file" menu item and press the [ENTER/YES] key.

The display goes down to the "RESTORE FILE" screen which shows the list of "hidden" audio files.

If no hidden file which can be restored exists, "No Deleted File!" is shown.

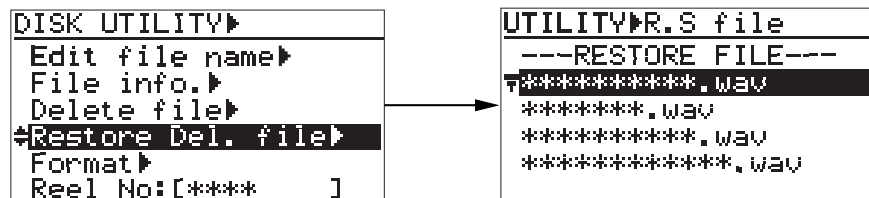

- 4) Select a file you want to restore using the [MENU] dial, and press the [ENTER/YES] key.

The unit restores the file.

After "Completed!" is shown, the display returns to the "DISK UTILITY" menu screen.

<Note>: The restored file has the same file name before it was deleted.

- 5) Press the [EXIT] key repeatedly until you exit the MENU mode.

Formatting a disk (or a hard disk partition) [Format]

Using the "Format" menu item, you can reformat a DVD-RAM disk or a partition of the internal hard disk drive in the UDF format.

For details about how to format an unformatted DVD-RAM disk, see "Initial format of a DVD-RAM disk" on page 34.

- 1) **While the unit is stopped, press the [SHIFT] key to light the [SHIFT] indicator, followed by the [ENTER/YES] key.**

The unit enters the MENU mode and the MENU list screen is shown.

- 2) **Use the [MENU] dial to select the "DISK UTILITY" menu item and press the [ENTER/YES] key.**

The display now shows the DISK UTILITY menu screen.

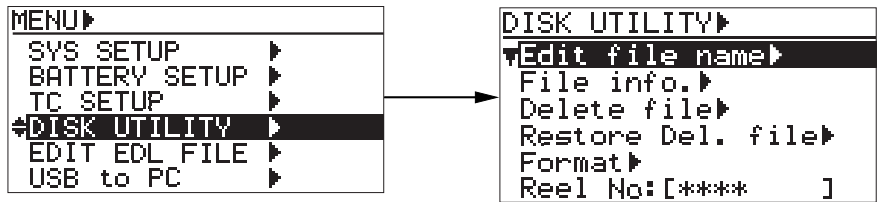

- 3) **Use the [MENU] dial to select the "Format" menu item and press the [ENTER/YES] key.**

The display now shows "Format" screen.

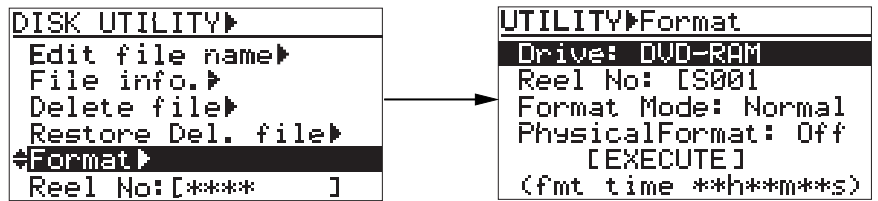

On this screen, you can make setting for the following items regarding formatting.

Drive	Selects a medium to be formatted. You can select from among "DVD-RAM" (a DVD-RAM set to the standard fitted DVD-RAM drive) and "PT01HD" through "PT16HD" (partitions of the internal hard disk drive). If the optional hard disk drive is not installed, "DVD-RAM" is the only option.
Reel No	Sets the reel number (volume label) of the selected medium. By default, the following numbers are set as the reel numbers. DVD-RAM -> S001 Partition -> PT01HD: S002, PT02HD: S003 PT16HD: S017
Format Mode	Selects the format mode between "Normal" and "DDR". You are going to perform Dual Drive Recording to a hard disk partition and a DVD-RAM disk, select "DDR".
Physical Format	Selects whether physical-formatting the DVD-RAM disk (or hard disk partition).

4) Make settings of the items.

• Drive selection:

While "Drive" is highlighted on the "Format" screen, press the [ENTER/YES] key. The currently selected drive flashes and you can now select the desired option ("DVD-RAM" or "PT01HD" through "PT16HD") using the [MENU] dial. After selecting the option, press the [ENTER/YES] key to confirm your setting. "Reel No", the next item, is automatically highlighted.

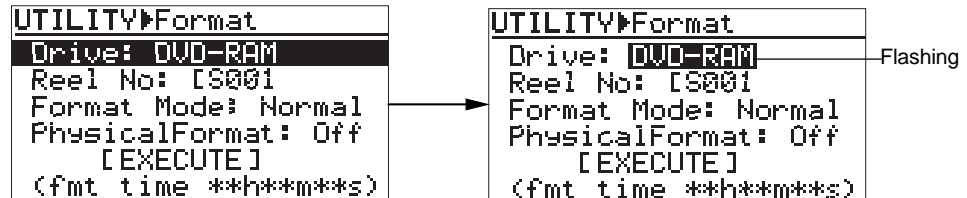

• Volume label setting:

While "Reel No" is highlighted, press the [ENTER/YES] key. The first character of the current volume label (by default, "1") flashes and you can now enter the desired label using the [MENU] dial and alphanumeric keys. You can move the cursor position using the [◀◀] / [▶▶] keys. Up to eight characters can be entered.

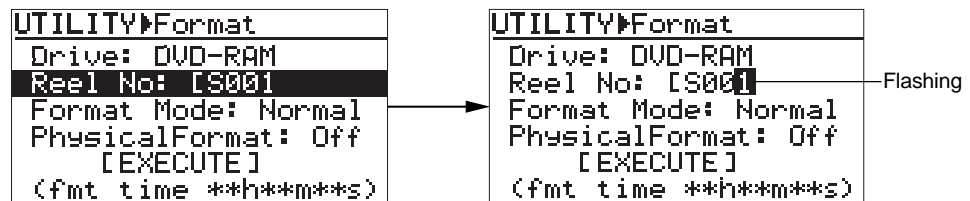

After entering the desired label, press the [ENTER/YES] key to confirm your setting. "Format Mode", the next item, is automatically highlighted.

You can also edit the volume label after formatting, using the "Reel No" menu item on the "DISK UTILITY" menu (see page 202).

<Note>: If you enter an illegal volume label and press the [ENTER/YES] key to confirm, the display pops up "Illegal Name!" and the entered volume label is not accepted.

• Format mode selection:

While "Format Mode" is highlighted, press the [ENTER/YES] key. The current setting (by default, "Normal") flashes and you can now select the format mode between "Normal" and "DDR" using the [MENU] dial. After selecting the desired mode, press the [ENTER/YES] key to confirm your setting.

<Note>: You cannot select "DDR", when the "Drive" item is set to "DVD-RAM".

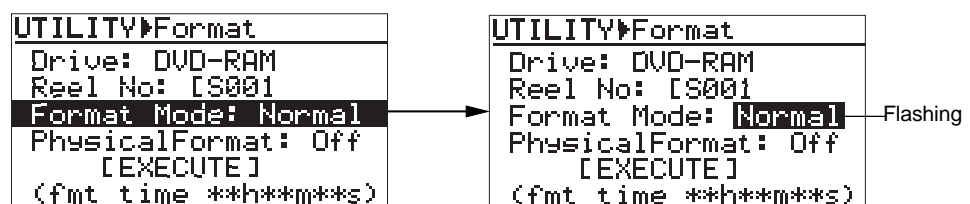

Normal	The medium selected by the "Drive" item (a DVD-RAM disk or hard disk partition) is formatted in the "Normal" mode. When setting the Format mode to "Normal", you can select On/Off of "Physical Format", the next item on the screen.
DDR	A hard disk partition selected by the "Drive" item, as well as a DVD-RAM disk set to the DVD-RAM drive, is formatted in the "DDR" mode. After executing formatting in this mode, the DVD-RAM disk is designated as a "mirror" disk for Dual Drive Recording. Dual Drive Recording records the same audio data to both the partition and DVD-RAM disk simultaneously. When formatting a partition in the "DDR" mode, you must set a DVD-RAM disk to the DVD-RAM drive. When setting the Format mode to "DDR", you can select On/Off of "Physical Format", the next item on the screen. See "Dual Drive Recording" on page 113 in "Advanced operation" for details about "DDR" mode formatting.

<Note>: When formatting a DVD-RAM disk in the "Normal" mode, the PD204 performs brief inspection of dirt, dust and defect on the medium even if "Physical Format" is set to "Off". However, note that the inspection cannot perfectly detect any dirt, dust and defects.

<Note>: It is recommended that you should format a partition and a DVD-RAM disk used for Dual Drive Recording in the "Normal" mode first, and then reformatting in the "DDR" mode.

<Note>: You cannot directly record only to a DVD-RAM disk which is set to the DVD-RAM drive when formatting a partition in the "DDR" mode, designated to the mirror disk of Dual Drive Recording. To make recording possible, reformat the disk in "Normal" mode.

• Physical format on/off setting

When selecting "Format Mode" to "Normal" or "DDR", you can select On or Off of the physical format.

While "Physical Format" is highlighted, press the [ENTER/YES] key.

The current setting (by default, "Off") flashes and you can now select the option between "Off" and "On" using the [MENU] dial.

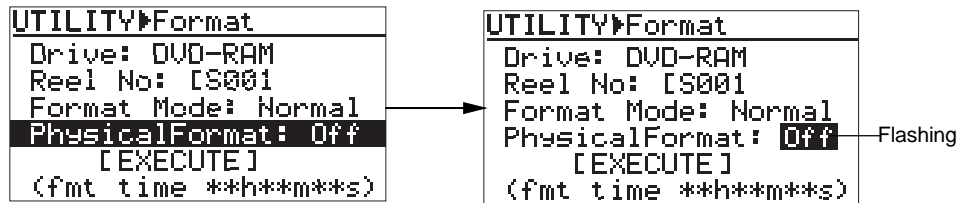

On	A whole DVD-RAM disk (or a hard disk partition) is physically formatted. It takes long to execute physical format, however, we recommend physically formatting a well-used DVD-RAM disk (or a hard disk partition).
Off	A DVD-RAM disk (or a hard disk partition) is formatted in a simple manner. We recommend selecting this option for a relatively new DVD-RAM disk (or a hard disk partition). The PD204 also performs simple inspection of dirt, dust and defect on a DVD-RAM disk when formatting.

<Note>: Do not turn off the power of the PD204 while executing the physical format.

<Note>: It takes a long time to execute the physical format. We recommended executing the physical format when disk access time becomes longer or sound interruption occurs in normal use. You do not need to physical format a brand-new or relatively new disk. However, regardless of whether the format mode is "Normal" or "DDR", there may be a case that "Physical Format" on the Format screen is automatically set to "On" and you cannot select "Off". In this case, the PD204 decides that the disk to be formatted needs the physical format and you must execute the physical format.

After selecting the desired option, pressing the [ENTER/YES] key automatically highlights "[EXECUTE]".

```

UTILITY▶Format
Drive: DVD-RAM
Reel No: [S001
Format Mode: Normal
PhysicalFormat: Off
[EXECUTE]
(fmt time **h**m**s)

```

- 5) **While "[EXECUTE]" is highlighted, press the [ENTER/YES] key.**
The "CAUTION" message appears and "Are you sure?" flashes.
To cancel formatting, press the [EXIT] key.

```

UTILITY▶Format
Drive: DVD-RAM
Reel No: [S001
Format Mode: Normal
PhysicalFormat: Off
[EXECUTE]
(fmt time **h**m**s)

```

→

```

UTILITY▶Format
---CAUTION---
If ENTER key is push
-ed.will start format
-tins and delete INT
DVD-RAM area data.
Are you sure?

```

Flashing

- 6) **Press the [ENTER/YES] key.**
The unit starts formatting the disk.
The display shows the formatting progress. When formatting completes, the display shows "Fmt. Completed!".

```

UTILITY▶Format
---FORMATTING!---
Drive: DVD-RAM
Time: **H**M**S
0          50          100%
|-----|-----|

```

→

```

UTILITY▶Format
---FORMATTING!---
Fmt. Completed!

```

<Note>: The progress indication shows estimated information. Do not carry out any operation until "Fmt. Completed!" is shown.

- 7) **Press the [EXIT] key repeatedly until you exit the MENU mode.**

<Note>: If you format a DVD-RAM disk while a hard disk partition is selected as the current drive, the DVD-RAM is not selected as the current partition after completing formatting. In other words, only when you format a partition of the internal hard disk while the DVD-RAM drive is selected as the current drive, the current drive changes after completing formatting.

Editing the reel number (Volume label) [Reel No]

Using the "Reel No" menu item, you can edit the reel number of the currently selected disk (or partition). Note that the reel number set here is also reflected to the volume label. The following procedure assumes that a disk (or partition) you want to edit the reel number of is loaded.

<Note>: If you edit the reel number (volume label) of the partition used for Dual Drive Recording, the edited result is also reflected to the DVD-RAM disk for Dual Drive Recording.

- 1) **While the unit is stopped, press the [SHIFT] key to light the [SHIFT] indicator, followed by the [ENTER/YES] key.**
The unit enters the MENU mode and the MENU list screen is shown.
- 2) **Use the [MENU] dial to select the "DISK UTILITY" menu and press the [ENTER/YES] key.**
The display now shows the DISK UTILITY menu screen.

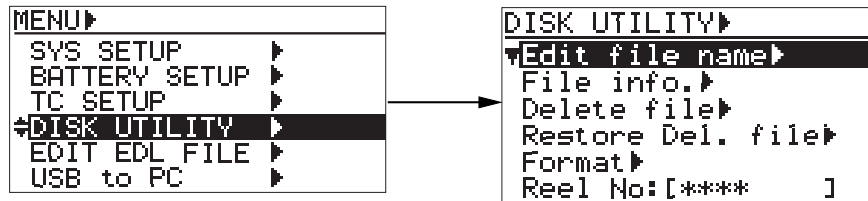

- 3) **Use the [MENU] dial to select the "Reel No" menu item and press the [ENTER/YES] key.**
The leftmost character of the current reel number flashes and you can now edit the reel number.

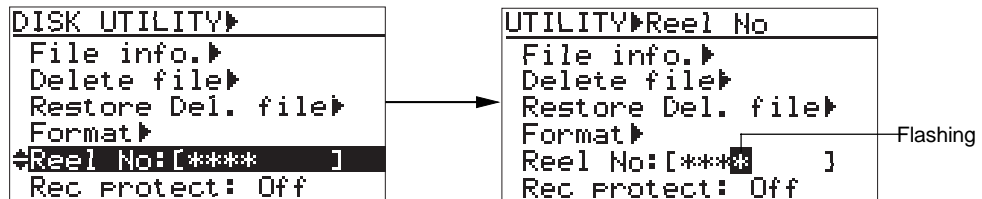

- 4) **Use the [MENU] dial or the alphanumeric keys to enter a desired reel number.**
Use the [◀◀] / [▶▶] keys to move the cursor position.
When using the alphanumeric keys for entering characters, pressing any other alphanumeric key moves the cursor to the right automatically.
You can enter up to eight characters for a reel number.
Pressing the [CLEAR] key clears the right next character to the cursor position.
- 5) **After editing the reel number, press the [ENTER/YES] key to confirm your setting.**
- 6) **Press the [EXIT] key repeatedly until you exit the MENU mode.**

Record protection On/Off setting [Rec protect]

Using the "Rec protect" menu item, you can select "On" or "Off" of the protection (record inhibit) for the currently loaded audio file.

The following procedure assumes that an audio file you want to make protection setting is loaded.

<Note>: You cannot edit a protected audio file.

- 1) While the unit is stopped, press the [SHIFT] key to light the [SHIFT] indicator, followed by the [ENTER/YES] key.
The unit enters the MENU mode and the MENU list screen is shown.
- 2) Use the [MENU] dial to select the "DISK UTILITY" menu and press the [ENTER/YES] key.
The display now shows the DISK UTILITY menu screen.

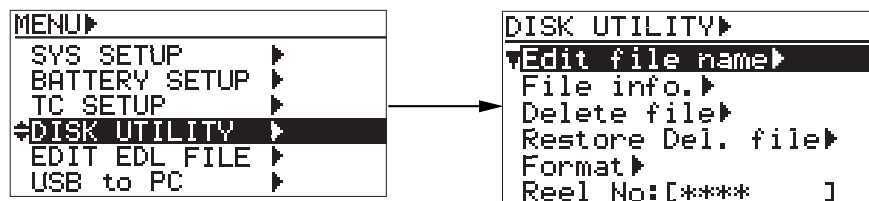

- 3) Use the [MENU] dial to select the "Rec protect" menu item and press the [ENTER/YES] key.
The current option ("On" or "Off") starts flashing (the default is "Off") and you can now select the desired option.

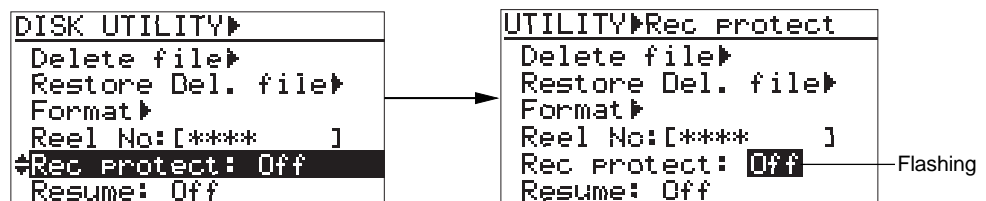

- 4) Use the [MENU] dial to select "On" or "Off", and press the [ENTER/YES] key to confirm your setting.

<Note>: If you enter the UTILITY menu when no file is available on the current disk, "Rec protect:--" is shown instead of "Rec protect: Off (or On)". This means there is no audio file to which the "Rec protection" setting is applied. If you select it and press the [ENTER/YES] key in this case, "Void!" is shown.

<Note>: The PD204 can protect each partition of the optional hard disk drive. See "Partition protection On/Off setting [Part. protect]" on page 205 for details.

- 5) Press the [EXIT] key repeatedly until you exit the MENU mode.

Resume function On/Off setting [Resume]

Using the "Resume" menu item, you can select "On" or "Off" of the resume function. By setting it to "On", the current audio file and its playback position is stored to the resume file when a DVD-RAM disk is ejected or a partition is changed. Therefore, the unit automatically loads the same audio file at the same position next time you set the same disk to the unit.

- 1) While the unit is stopped, press the [SHIFT] key to light the [SHIFT] indicator, followed by the [ENTER/YES] key.

The unit enters the MENU mode and the MENU list screen is shown.

- 2) Use the [MENU] dial to select the "DISK UTILITY" menu and press the [ENTER/YES] key.

The display now shows the DISK UTILITY menu screen.

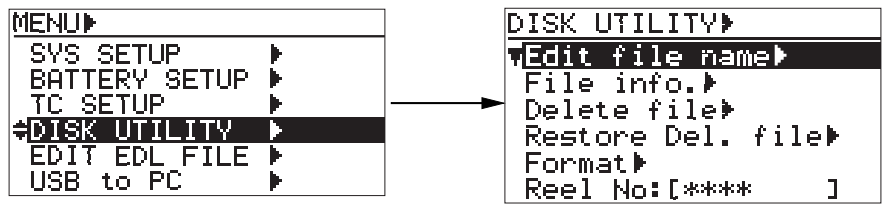

- 3) Use the [MENU] dial to select the "Resume" menu item and press the [ENTER/YES] key.

The current option ("On" or "Off") starts flashing (the default is "Off") and you can now select the desired option.

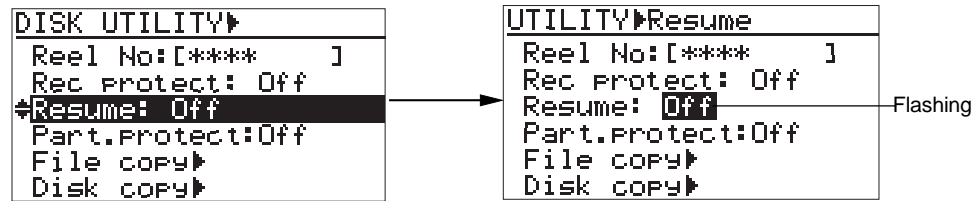

- 4) Use the [MENU] dial to select "On" or "Off", and press the [ENTER/YES] key to confirm your setting.

- 5) Press the [EXIT] key repeatedly until you exit the MENU mode.

Partition protection On/Off setting [Part. protect]

Using the "Part. protect" menu item, you can select "On" or "Off" of the software protection (record inhibit) for the current partition.

The following procedure assumes that a partition you want to make protection setting is selected as the current drive.

<Note>: If a partition is not selected as the current drive, "---" is shown.

- 1) While the unit is stopped, press the [SHIFT] key to light the [SHIFT] indicator, followed by the [ENTER/YES] key.
The unit enters the MENU mode and the MENU list screen is shown.
- 2) Use the [MENU] dial to select the "DISK UTILITY" menu and press the [ENTER/YES] key.
The display now shows the DISK UTILITY menu screen.

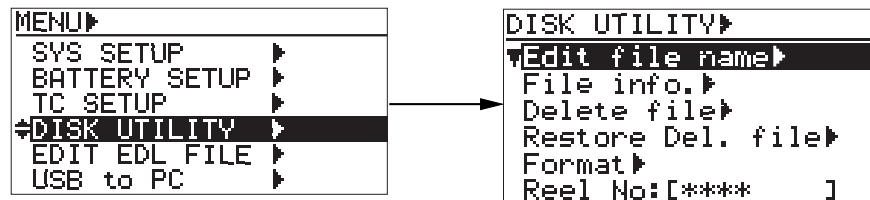

- 3) Use the [MENU] dial to select the "Part. protect" menu item and press the [ENTER/YES] key.
The current option ("On" or "Off") starts flashing (the default is "Off") and you can now select the desired option.

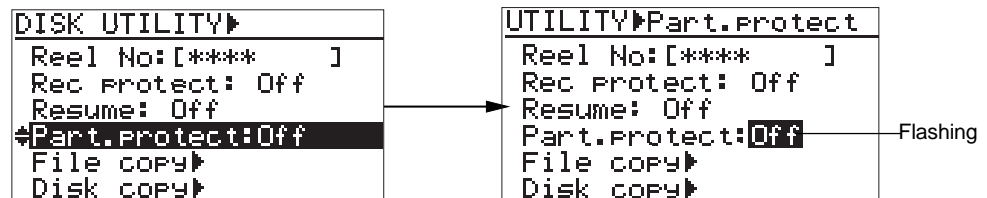

- 4) Use the [MENU] dial to select "On" or "Off", and press the [ENTER/YES] key to confirm your setting.
- 5) Press the [EXIT] key repeatedly until you exit the MENU mode.

<Note>: When a protected partition is loaded, the "🔒" icon is shown on the Home display as well as the DRIVE SEL display as shown below.

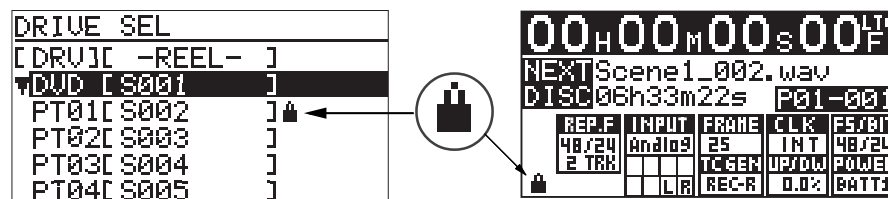

HDD operating time display [HDD Ope. Time]

Using the "HDD Ope. Time" item, you can view the operating time of the internal hard disk drive since it is formatted at the factory.

<Note>: The internal hard disk drive as well as the optional hard disk drive (Model EX-HD1) is formatted at the factory and then used for testing and inspection. Therefore, if you check the hard disk operating time just after purchasing the unit, it may not show "0000H".

- 1) **While the unit is stopped, press the [SHIFT] key to light the [SHIFT] indicator, followed by the [ENTER/YES] key.**

The unit enters the MENU mode and the MENU list screen is shown.

- 2) **Use the [MENU] dial to select the "DISK UTILITY" menu and press the [ENTER/YES] key.**

The display now shows the DISK UTILITY menu screen.

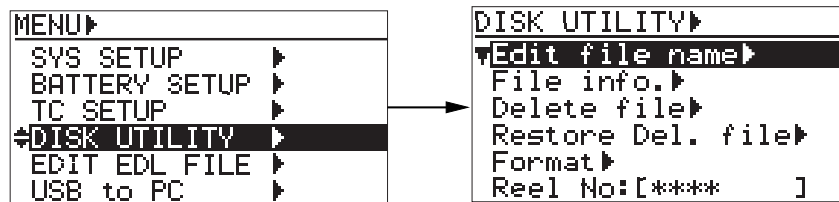

- 3) **Use the [MENU] dial to scroll down the screen until you can see the "HDD Ope. Time" item at the bottom.**

The current operating time of the hard disk drive is shown.

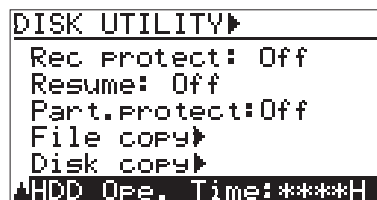

- 4) **Press the [EXIT] key repeatedly until you exit the MENU mode.**

LOAD SETUP menu

Using the “LOAD SETUP” menu item, you can load setup data from among user setup data (“Box No 0” through “Box No6”) and default setup data.

A user setup data can be saved using the “SAVE SETUP” menu (described on next page).

- 1) While the unit is stopped, press the [SHIFT] key to light the [SHIFT] indicator, followed by the [ENTER/YES] key.
- 2) Use the [MENU] dial to select the “LOAD SETUP” menu and press the [ENTER/YES] key. The display now shows the LOAD USER SETUP screen for selecting a desired user (or default) setup box.

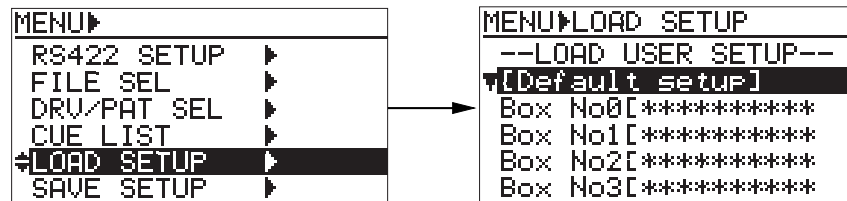

- 3) Use the [MENU] dial to select the desired box and press the [ENTER/YES] key. The data is immediately loaded. After “Completed!” is shown, the display returns to show the MENU list screen.

<Note>: If you select "[Default setup]" and the default setup data is loaded, all settings in the "SYS SETUP" menu are initialized. If you select and load any user box, the saved settings are loaded.

- 4) Press the [EXIT] key repeatedly until you exit the MENU mode.

SAVE SETUP menu

Using the “SAVE SETUP” menu item, you can save the current data to user box. The saved data can be loaded using the “LOAD SETUP” menu at any time.

<Note>: The default file names and track names, as well as event numbers, are not saved.

- 1) While the unit is stopped, press the [SHIFT] key to light the [SHIFT] indicator, followed by the [ENTER/YES] key.
- 2) Use the [MENU] dial to select the “SAVE SETUP” menu and press the [ENTER/YES] key. The display now shows the SAVE USER SETUP screen for selecting a desired user setup box to which the current setting is saved.

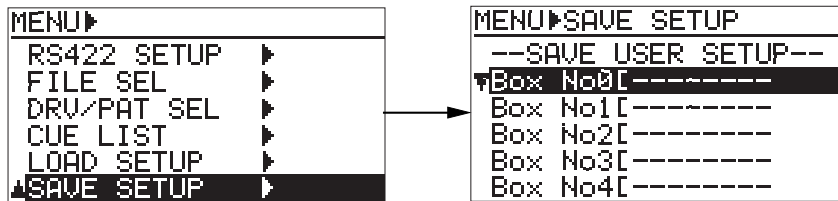

- 3) Use the [MENU] dial to select the desired box and press the [ENTER/YES] key. Now you can enter the user box name. The first character of the current box name (in the example below, “0” of “User0”) flashes.

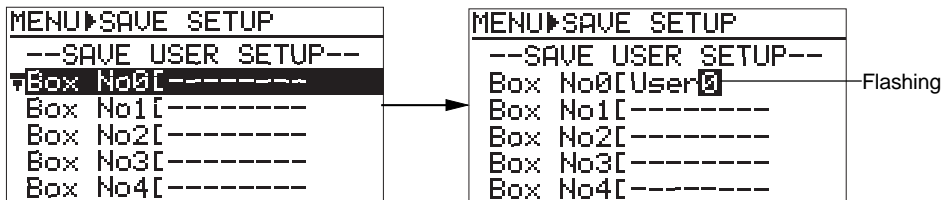

User box selection:

You can select between “Box No0” and “Box No6”.

User box name entry:

You can enter up to eight ASCII characters.
 You can clear the current name by pressing the [CLEAR] key repeatedly.
 You can enter a character at the cursor position using the [MENU] dial or alphanumeric keys.

- 4) After entering a desired box name, press the [ENTER/YES] key to save data. The data is immediately saved. After “Completed!” is shown, the display returns to show the MENU list screen.
- 5) Press the [EXIT] key repeatedly until you exit the MENU mode.

Chapter 9: Specifications

Inputs/outputs

* 0dBu = 0.775Vrms, 0dBV = 1Vrms, Reference level: -20dBFS

ANALOG INPUT (CH1 ~ 4)	LINE	Connectors	: XLR-3-31 type (balanced, pin 2: hot)
		Input impedance	: More than 10k Ω
		Input level	: +4dBu ~ -32dBu
	MIC	Maximum input level	: +24dBu
		Input impedance	: More than 2k Ω
		Input level	: -34dBu ~ -70dBu
		Maximum input level	: -14dBu
AUX INPUT (L, R)			
		Connectors	: XLR-3-31 type (balanced, pin 2: hot)
		Input impedance	: More than 10k Ω
		Input level	: +4dBu
		Maximum input level	: +24dBu
ANALOG OUTPUT (L, R)			
		Connectors	: XLR-3-32 type (balanced, pin 2: hot)
		Output load impedance	: More than 10k Ω
		Reference output level	: +4dBu/-10dBu/-60dBu (The reference output level is selected in the SYS SETUP menu of the MENU mode.)
		Maximum output level	: +24dBu
PHONES			
		Connector	: 6mm dia stereo phone jack
		Applicable load impedance	: More than 32 Ω
		Maximum output level	: 200mW (at 32 Ω)
DIGITAL IN			
		Connectors	: XLR-3-31 type (balanced, pin 2: hot)
		Format	: IEC60958 Part2 (S/P DIF) or IEC 60958 Part3 (AES/EBU), auto selection
DIGITAL OUT			
		Connectors	: XLR-3-32 type (balanced, pin 2: hot)
		Format	: IEC60958 Part2 (S/P DIF) or IEC 60958 Part3 (AES/EBU), The format of an output signal is selected in the SYS SETUP menu of the MENU mode.
TIME CODE IN			
		Connector	: XLR-3-31 type (balanced, pin 2: hot)
		Format	: SMPTE/EBU
		Input impedance	: More than 20k Ω
		Reference input level	: 2V p-p
		Minimum input level	: 0.25V p-p
TIME CODE OUT			
		Connector	: XLR-3-32 type (balanced, pin 2: hot)
		Format	: SMPTE/EBU
		Output impedance	: Less than 1k Ω
		Reference output level	: 2V p-p
		Output load impedance	: More than 600 Ω
VIDEO/WORD IN			
		Connector	: BNC type (auto software selection)
		Reference input level	: TTL level (with 75 Ω termination switch)
WORD OUT			
		Connector	: BNC type
		Output level	: TTL level
PARALLEL REMOTE			
		Connector	: MINI DIN 8pin (female)
9P-REMOTE			
		Connector	: D-sub 9pin
USB (KYBD)			
		Connector	: USB Series A Receptacle

USB (PC)	Connector	: USB Series B Receptacle
USB (HOST)	Connector	: USB Series A Receptacle
DC IN	Connector	: XLR-4-32 type (male)
	Input power requirement	: DC12V ~ 24V
DC OUT	Connector	: Hirose 4pin (female)
		(Matched connector: HIROSE HR10A-7P-4P)
	Rated output voltage	: DC12V ~ 24V (Max.0.5A)

Recording/playback

Recording medium	: DVD-RAM, DVD-R/RW, CD-R/RW (DVD-R/RW, CD-R/RW can used for data backup only.) : 1.8-inch hard disk drive
Sampling frequency/quantization	: 44.1kHz/48kHz 16bit : 44.1kHz/48kHz/88.2kHz/96kHz/176.4kHz/192kHz 24bit
Recording track	: 2 tracks
R/P frequency response	: 20Hz ~ 20kHz, 1dB (FS 44.1/48kHz) : 20Hz ~ 40kHz, 2dB (FS 88.2/96kHz) : 20Hz ~ 70kHz, 3dB (FS 176.4/192kHz)
Signal to Noise ratio (ADC-DAC, 24bit, Ref: -20dBFS, Fs: 48kHz) LINE (INPUT GAIN: +4dBu)	: 107dB (Typical)
Dynamic range (ADC-DAC, 24bit, Ref: -20dBFS, Fs: 48kHz, LINE)	: 105dB (Typical)
Reference recording level	: -20dBFS
T. H. D.	: Less than 0.003% (1kHz, -1dBFS, ADC-DAC, 24bit REF.: -20dBFS, fs: 48kHz) (Typical)
Cue point chunk	: 100

General

Dimensions	: 116.5 (H) x 325 (W) x 234 (D) mm
Weight	: Approximately 3.3kg
Power source	: Optional AC adaptor, DC11.5V ~ 24V : IDX endure battery
Power consumption	: Approximately 17W 15V, 1.3A

- *  is a trademark of DVD format/Logo Licensing Corporation.
- * Specifications and appearance are subject to change without notice for product improvement.
- * IDX, IDX (logo), ENDUR, V-Mount, V-Plate, Digi-View, i-Trax are a trademark of IDX Company Ltd..

Physical dimensions

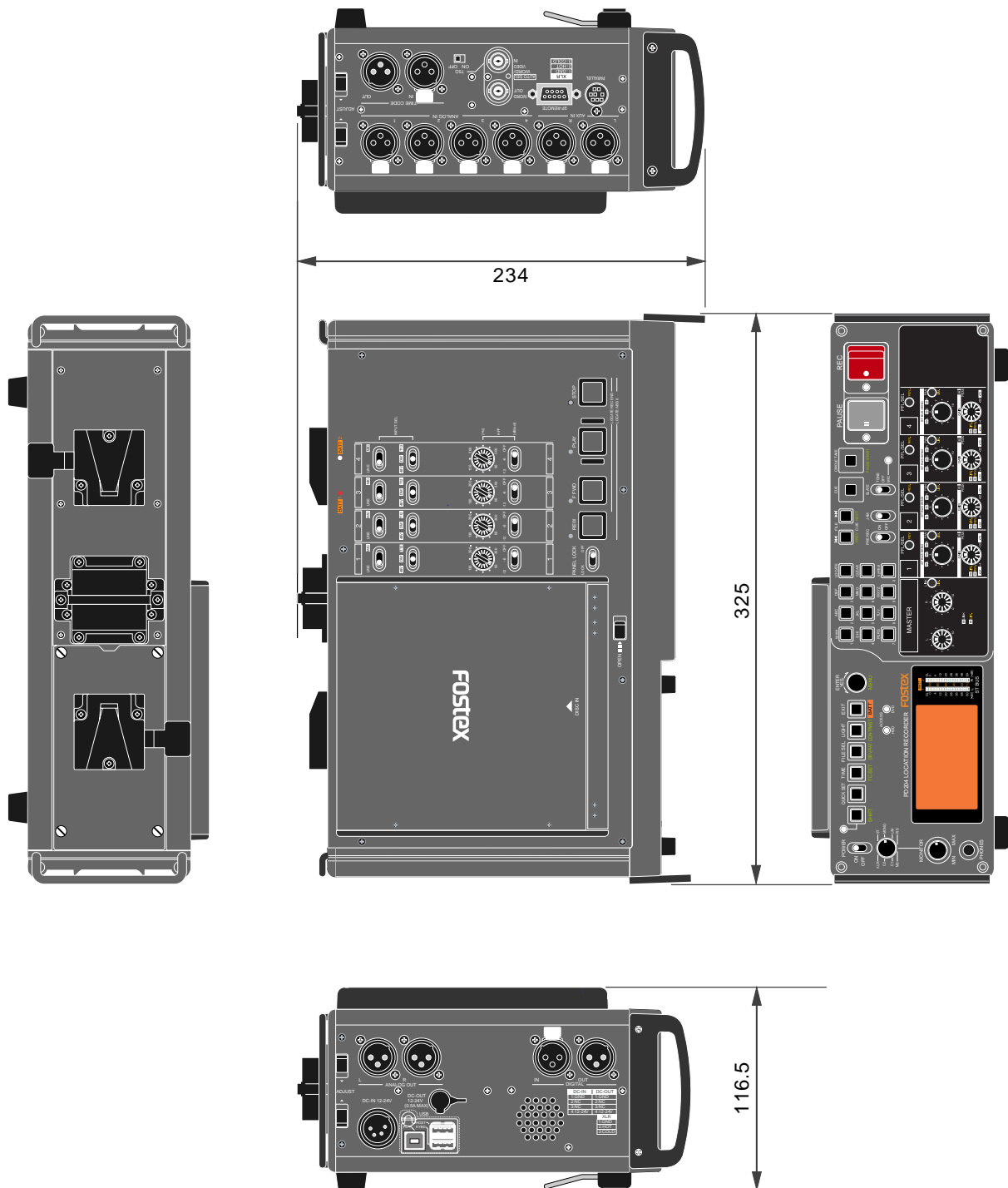

Block diagram

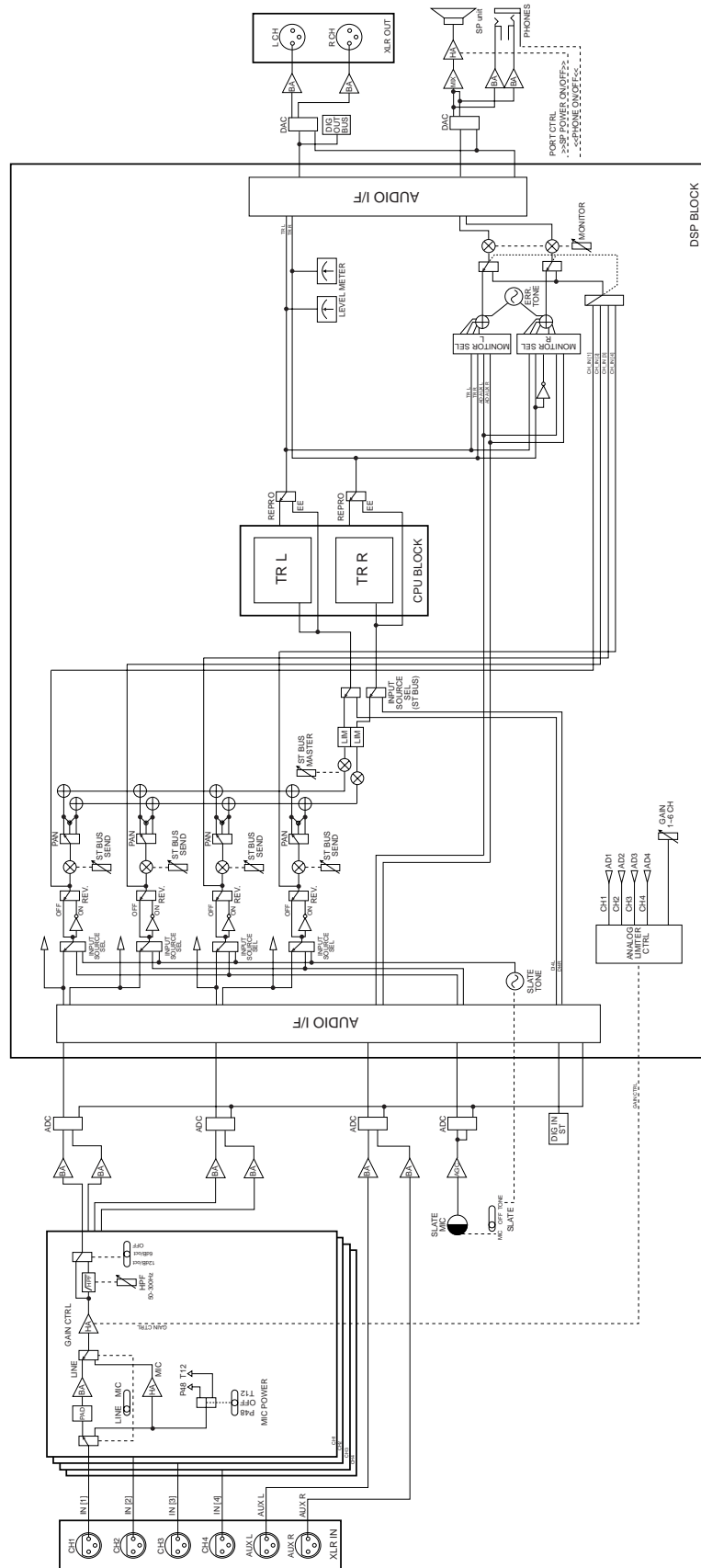

Index

- A**
- AC adaptor22, 28
 - ALE file121
 - @ mark126
 - Auto copy104
 - Auto copy mode105
- B**
- Battery status173
 - Battery remain172
 - Battery22-27, 165
 - Back light30
 - Battery warning166
 - Back ground mode104
 - BATT indicator29
 - Bar graph26
 - Battery plate19
 - Battery condition26
 - Bit rate.....76, 89, 142
 - BWF Manager116
- C**
- Chain play163
 - Channel link82
 - Copy mode104
 - Controller connection68
 - Contrast30
 - Connection61
 - Continuous recording77, 153
 - Cueing playback97
 - Cue point setting93
 - Current drive57, 84
- D**
- Date138
 - DC-IN28
 - DDR mode113, 198
 - Deleting a file196
 - Digi in175
 - Disk warning162
 - Digital format144
 - Disk copy107
 - Digital signal connection63, 65
 - Disk remain57
 - Drive selection84, 104, 107, 110
 - Dual drive recording113
 - DVD-RAM disk33
- E**
- Error tone160
 - Editing an ALE file129
 - Eject lever27
 - Endura battery22
 - Editing a cue point94
- F**
- Event number141
 - False start86, 155
 - File information192
 - File name31, 57, 77, 138, 191
 - File copy110
 - File number57
 - Format33, 113, 198
 - Format mode34, 113, 199
 - Force jam92
 - Frame rate75, 90, 176
 - Full area108
- G**
- Gain80
 - Grouping156
- H**
- Hidden file196, 197
 - High pass filter79
 - Holder plate22
 - Home display55
- I**
- IDX22
 - Immediately mode104
 - Internal TC generator.....178
 - Input gain80
 - Input connection62
 - INT (Internal)75, 175
 - Internal hard disk drive37
 - Internal clock31
 - Input clip161
 - iXML Chunk data195
- J**
- Jam mode182
- K**
- Keyboard66, 150
 - Key icon57, 205
- L**
- Lithium battery12
 - Limiter79, 156
 - Link82
 - Locate98
 - Loading the setup data207
 - LTC start time184, 185
- M**
- Main power supply22
 - Maximum recording area77, 152

MENU mode	77, 133	Saving the setup data	208
Mirror disk	113	Scene name	138
Mixer	78	Skip	98
Monitoring	83	Slate tone	88, 147
Mute	159	Slate microphone	88
N		Sound Sequence information	192
Next file name	57	Speaker mute	159
Normal mode	34, 198	Stereo bus	82
NP-1 type battery	22	Status information	56
O		Sync signal	63
Off timer	189	System clock	75, 89, 175
Option	19	T	
Operating time	206	Take	138
Output connection	64	TC power timer	189
Overload	86	Threshold	156
P		Time code	90, 183
Parameter	156	Time code connection	63
Partition	29, 84, 104, 107, 110, 205	Time display	55
Pause time	149	Track name	140
PC connection	68, 116	U	
Peak hold	146	User box	207, 208
Phantom power	79	User bit	180
Physical format	198	V	
Phase	82	Version	164
Playback	96	Video	138
Pop tone	147	W	
Power on/off	29, 30	WORD	175
Power link	24	Write error	160
Power priority	168	Z	
Power connection	69	Zero-crossing	81
Pre fader listen	83		
Pre recording	87, 151		
Preparation before recording	74		
Protect	57, 203, 205		
Protector	25		
Project name	137		
Pull up/pull down	76, 143		
Q			
Quick setup mode	74		
R			
Ratio	157		
Reel Number	36, 138, 202		
Rec area	108		
Record protection	203, 205		
Recording analog audio	85		
Recording time code	90		
Recording digital audio	89		
Release button	27		
Resume	204		
Restore deleted file	197		
S			
Sampling frequency	76, 89, 142		

Declaration of EC Directive

This equipment is compatible with the EMC Directive (2004/108/EC) - Directive on approximation of member nation's ordinance concerning the electromagnetic compatibility and with the Low Voltage Directive (2006/95/EC) - Directive on approximation of member nation's ordinance concerning electric equipment designed to be used within the specified voltage range.

The Affect of Immunity on This Equipment

The affect of the European Specification EN61000-6-1 (coexistence of electromagnetic waves - common immunity specification) on this equipment are as shown below.

In the electrical fast transient/burst requirements, surge, conducted disturbances by radio-frequency fields, power frequency magnetic field, radiate electromagnetic field requirements and static electricity discharging environment, this could be affected by generation of noise in some cases.

FOSTEX DISTRIBUTORS LIST IN EUROPE

* Including non-EU countries (as of March, 2007)

<AUSTRIA>

NAME: ATEC Audio-u. Videogeraete
VertriebsgesmbH.
ADD: Im Winkel 5, A-2325 Velm, Austria
TEL: (+43) 2234-74004, FAX: (+43) 2234-74074

<BELGIUM>

NAME: General Audio
ADD: Raymond Pelgrimslaan 101, B-1702 Groot-Bijgaarden, Belgium
TEL: (+32) 2-4630650, FAX: (+32) 2-4661500

<DENMARK>

NAME: SC Sound ApS
ADD: Malervej 2, DK-2630 Taastrup, Denmark
TEL: (+45) 4399-8877, FAX: (+45) 4399-8077

<FINLAND>

NAME: Noretron Oy Audio
ADD: P. O. Box 22, FIN-02631 Espoo, Finland
TEL: (+358) 9-5259330, FAX: (+358) 9-52593352

<FRANCE>

NAME: Sennheiser France
ADD: 128 bis, avenue Jean-Jaures, 94851 Ivry-sur-Seine Cedex, France
TEL: (+33) 1 4987 0300, FAX: (+33) 1 4987 0324

<GERMANY>

NAME: Mega Audio GmbH
ADD: Stromberger Str. 32, D-55411 Bingen, Germany
TEL: (+49) 6721-94330, FAX: (+49) 6721-32046

<GREECE>

NAME: Bon Studio S. A.
ADD: 6 Zaimi Street, Exarchia, 106.83 Athens, Greece
TEL: (+30) 210-3809-605, 606, 607, 608
FAX: (+30) 210-3845-755, 210-3827-868

<ICELAND>

NAME: I. D. elrf. electronic Ltd.
ADD: ARMULA 38 108 REYKJAVIK, ICELAND
TEL: (+354) 588 5010, FAX: (+354) 588 5011

<ITALY>

NAME: Proel S. p. A.
ADD: Zona Via Alla Ruenia, 37/43 64027 - Sant'Omero (Teramo), Italy
TEL: (+39) 0861-81241, FAX: (+39) 0861-887862

<THE NETHERLANDS>

NAME: IEMKE ROOS AUDIO B. V.
ADD: Kuiperbergweg 20, 1101 AG Amsterdam, The Netherlands
TEL: (+31) 20-697-2121, FAX: (+31) 20-697-4201

<NORWAY>

NAME: Siv. Ing. Benum AS
ADD: P.O. Box 145, Vinderen, 0319 Oslo, Norway
TEL: (+47) 2213 9900, FAX: (+47) 2214 8259

<SPAIN>

NAME: Letusa S. A.
ADD: C/Laguna 10, 28923 Alcorcon, Madrid, Spain
TEL: (+34) 91-4862800, 91-4470898
FAX: (+34) 91-6414597

<SWEDEN>

NAME: Kinovox-Benum A/B
ADD: Solna Strandvag 78 171 54 Solna, Sweden
TEL: (+46) 8 5052 1176, FAX: (+46) 8 5052 1010

<SWITZERLAND>

NAME: Audio Bauer Pro AG
ADD: Bernerstrasse-Nord 182, CH-8064 Zurich, Switzerland
TEL: (+41) 1-4323230, FAX: (+41) 1-4326558

<UK>

NAME: SCV London
ADD: 40 Chigwell Lane, Oakwood Hill Industrial Estate, Loughton, Essex IG10 3NY U. K.
TEL: (+44) 20-8418-0778
FAX: (+44) 20-8418-0624

FOR THE US CUSTOMERS ONLY

FOSTEX AMERICA LIMITED WARRANTY

The following statement defines specific legal rights. You may also have additional rights depending on the state in which the Fostex product was purchased.

WARRANTY PROTECTION

All Fostex parts are warranted for one (1) year from the date of original purchase, except for recording media, such as hard disc drives and compact flash cards, heads, lamps and fuses, which are warranted, for one hundred-eighty (180) days. Fostex America will repair and / or replace parts during the term of this warranty. Labor costs are also covered by Fostex America for one (1) year from the date of original purchase. Except as specified below, this warranty covers all defects in material and workmanship in this product.

The following are not covered by this warranty:

1. Batteries.
2. Damage to any product that has been altered.
3. Damage to any product on which the original serial number has been defaced, modified or removed.
4. Damage to or deterioration of the external cabinet.
5. Damage occurring during shipment of the product. (NOTE: Shipping claims must be presented to the carrier.)
6. Damage resulting from accident, misuse, abuse or neglect.
7. Damage resulting from failure to perform routine maintenance and / or calibration procedures.
8. Damage resulting from failure to follow instruction in the owner's manual.
9. Damage resulting from repair or attempted repair or by someone other than a Fostex America Service technician or a technician at an authorized Fostex America service station.
10. Damage resulting from causes other than product defects, including lack of technical skill, competence or experience on the part of the user.
11. External appearance items such as cosmetic parts, knobs, liquid crystal displays, buttons, etc.
12. Replacements or repairs necessitated by loss or damages resulting from any cause beyond the control of Fostex America.
13. Damage resulting from misuse or abuse on rental units.

NOTE: FOSTEX AMERICA IS NOT RESPONSIBLE FOR DATA LOST OR DAMAGED DURING OPERATION OF THIS PRODUCT. CALIBRATION AND MAINTENANCE PROCEDURES ARE NOT COVERED BY THIS WARRANTY.

Fostex America reserves the right to inspect all products submitted pursuant to this warranty. If such an inspection shows reasonable cause to believe that any of the above exclusions to the above warranty are applicable, then Fostex America or the authorized service station will charge prevailing service rates and parts, costs for any repairs.

FOSTEX AMERICA LIMITED WARRANTY

To claim all warranty service, first access www.fostex.com to receive service authorization (RMA number). Then present the authorization together with the bill of sale, which shows the date of original purchase to Fostex America. This warranty is not transferable.

SHIPPING

If this product needs service, you must take it, or package it carefully, using ample packaging materials to prevent damage during shipment and mail it to the distributor from whom you have purchased this product, postage pre-paid and insured.

NOTE: Fostex America will not assume responsibility for damages or losses occurred in transit, but will reasonably assist the sender in processing any claims whenever possible (such as submitting statements to the carriers when applicable).

Any collect or C.O.D. shipments will be refused. In order to obtain warranty repairs, you must include the following:

1. Date proof of original purchase (copy of bill of sale or charge slip).
2. A note describing the problem with sufficient particularity to allow Fostex America to inspect or adjust the problem.
3. All accessory items appurtenant to that problem.

LIMITATIONS OF IMPLIED WARRANTIES AND EXCLUSIONS OF CERTAIN DAMAGES

Unless considered unenforceable or unlawful under applicable law:

- A. All implied warranties - including warranties of merchantability and fitness for a particular purpose - are limited in duration to term of this warranty and to the express coverage of this warranty;
- B. Fostex America's liability for any defect product is expressly limited to repair or replacement of the product, at the sole discretion and / or option of Fostex America. Fostex America shall not under any circumstances be liable for:
 1. Damaged based on inconvenience, loss of use of the product, loss of time, interrupted operation or commercial loss, OR;
 2. Any damages, whether incidental, consequential or otherwise, except damages which may not be excluded by under applicable law.
- C. Fostex America makes no other warranties, express or implied, above and / or beyond the representations made herein.

WARRANTY APPLIES ONLY TO THOSE PRODUCTS SOLD AND DISTRIBUTED BY FOSTEX AMERICA

Service Department

FOSTEX AMERICA

9 Mars Court Boonton, NJ 07005

TEL: 973-394-0015 FAX: 973-394-0800

Email: support@fostexusa.com

Web: www.fostex.com

Fostex[®]

FOSTEX CO.

3-2-35 Musashino, Akishima-shi, Tokyo, Japan 196-0021