

Owner's Manual

Model
DMT-8 VL

Digital Multitracker



Fostex

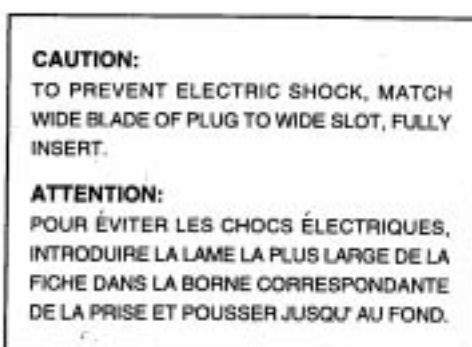

The lightning flash with arrowhead symbol, within an equilateral triangle, is intended to alert the user to the presence of uninsulated "dangerous voltage" within the product's enclosure that may be of sufficient magnitude to constitute a risk of electric shock to persons.



The exclamation point within an equilateral triangle is intended to alert the user to the presence of important operating and maintenance (servicing) instructions in the literature accompanying the appliance.

"WARNING"

"TO REDUCE THE RISK OF FIRE OR ELECTRIC SHOCK, DO NOT EXPOSE THIS APPLIANCE TO RAIN OR MOISTURE."

SAFETY INSTRUCTIONS

1. Read Instructions - All the safety and operating instructions should be read before the appliance is operated.
 2. Retain Instructions - The safety and operating instructions should be retained for future reference.
 3. Heed Warnings - All warnings on the appliance and in the operating instructions should be adhered to.
 4. Follow Instructions - All operating and use instructions should be followed.
 5. Water and Moisture - The appliance should not be used near water - for example, near a bathtub, washbowl, kitchen sink, laundry tub, in a wet basement, or near a swimming pool, and the like.
 6. Carts and Stands - The appliance should be used only with a cart or stand that is recommended by the manufacturer.
-
- An appliance and cart combination should be moved with care. Quick stops, excessive force, and uneven surfaces may cause the appliance and cart combination to overturn.
7. Wall or Ceiling Mounting - The appliance should be mounted to a wall or ceiling only as recommended by the manufacturer.
 8. Ventilation - The appliance should be situated so that its location or position does not interfere with its proper ventilation. For example, the appliance should not be situated on a bed, sofa, rug, or similar surface that may block the ventilation openings; or, placed in a built-in installation, such as a bookcase or cabinet that may impede the flow of air through the ventilation openings.
 9. Heat - The appliance should be situated away from heat sources such as radiators, heat registers, stoves, or other appliances (including amplifiers) that produce heat.
 10. Power Sources - The appliance should be connected to a power supply only of the type described in the operating instructions or as marked on the appliance.
 11. Grounding or Polarization - The precautions that should be taken so that the grounding or polarization means of an appliance is not defeated.
 12. Power Cord Protection - Power supply cords should be routed so that they are not likely to be walked on or pinched by items placed upon or against them, paying particular attention to cords at plugs, convenience receptacles, and the point where they exit from the appliance.
 13. Cleaning - The appliance should be cleaned only as recommended by the manufacturer.
 14. Nonuse Periods - The power cord of the appliance should be unplugged from the outlet when left unused for a long period of time.
 15. Object and Liquid Entry - Care should be taken so that objects do not fall and liquids are not spilled into the enclosure through openings.
 16. Damage Requiring Service - The appliance should be serviced by qualified service personnel when:
 - A. The power supply cord or the plug has been damaged; or
 - B. Objects have fallen, or liquid has been spilled into the appliance; or
 - C. The appliance has been exposed to rain; or
 - D. The appliance does not appear to operate normally or exhibits a marked change in performance; or
 - E. The appliance has been dropped, or the enclosure damaged.
 17. Servicing - The user should not attempt to service the appliance beyond that described in the operating instructions. All other servicing should be referred to qualified service personnel.

Table of Contents

Introduction.....	6
Precautions.....	6
Notes about power supply.....	6
Notes on handling the hard disk.....	7
Notes on the setup location.....	7
Notes on repair.....	8
About copyrights.....	8
About damages.....	8
Main Features of DMT-8VL.....	9
Names and Functions.....	14
Top panel (Mixer section).....	14
Top panel (Recorder section).....	16
Front panel (I/O connections).....	25
Rear panel (I/O connections).....	25
Display section.....	27
1. Display shown when the power is turned on.....	27
2. Preset display.....	27
3. Switching the display using the DISP SEL key.....	28
4. Switching the Time Base display using the EXECUTE/YES key and DISP SEL key.....	29
5. Changing Programs using the STORE key and the HOLD/> key.....	30
6. Warning messages.....	31
Before operating the DMT-8VL.....	34
1. Layout of the DMT-8VL top panel.....	34
2. Difference between track and channel.....	35
3. Function of the PAN knob and about the stereo bus.....	35
4. The difference between a tapa-based multitracker and a hard disk multitracker.....	36
5. Input monitor and Repro monitor.....	37
6. Time Base.....	38
7. Effect Connection.....	39
8. Installing the hard disk.....	41
Installing the hard disk unit (newly).....	42
Replacing the another hard disk unit.....	43
Formatting a hard disk.....	44
Recording/Playback (Basic Guide).....	45
1. The default setting on the DMT-8VL.....	45
2. Basic analog data recording (before starting multitrack recording).....	46
3. Recording while using the Program Change function (Switching Programs 1 ~ 5).....	50
4. Multitrack recording using overdubbing.....	52
Step 1: Recording a drum machine to Track 1.....	52
Step 2: Overdubbing an electric bass to Track 2.....	54

Step 3: Overdubbing an electric guitar on Track 3.....	56
Step 4: Overdubbing the vocal on Track 4.....	58
5. Mixdown.....	60
6. Digital Recording from an External Digital Device to the DMT-8vL.....	62
7. Digital Recording from the DMT-8vL to an External Digital Device.....	63
Recording/Playback (Application Guide).....	65
1. Ping-pong recording.....	65
2. MIDI Clock synchronization system.....	67
3. MTC Synchronization/Machine Control system.....	69
4. Synchronizing multiple DMT-8vL in Slave mode.....	72
5. Using only the recorder section on the DMT-8vL.....	74
6. Four-tracks simultaneous recording using the digital recording function.....	75
Punch In/Out.....	76
1. Auto Punch In/Out.....	77
Storing the Punch In/Out point.....	78
Auto Punch In/Out Rehearsal mode.....	80
Auto Punch In/Out Take mode.....	82
2. Punch In/Out recording using a foot switch.....	83
Punch In/Out Rehearsal.....	84
Punch In/Out Take.....	85
Locate function.....	87
1. Locate.....	87
2. Auto Play mode.....	88
3. Auto Return mode.....	88
Setting the Auto Return Start/End point.....	89
4. Auto Repeat mode.....	92
Edit function.....	93
1. Copy & Paste.....	94
Copying.....	94
Copy & Pasting.....	96
2. Move & Paste.....	99
Moving.....	99
Move & Pasting.....	101
3. Erase & Cut.....	104
Erasing.....	105
Cutting.....	106
Setup mode.....	108
1. Entering Setup mode.....	108
2. Setting the time signature ("BAR#").....	113
3. Tempo setting ("TEMPO").....	114
4. Metronome function On/Off ("CLICK" ON/OFF).....	116
5. Saving and loading the recordings ("SAVE", "LOAD").....	117
6. Formatting the hard disk ("FORMAT").....	123

7. Setting the preroll time for the locate operation ("PREROLL TIME").....	124
8. Selecting the synchronized signal output from the MIDI OUT connector ("MIDI SYNC OUT").....	125
9. Setting the MTC frame rate ("FRAME RATE").....	126
10. Setting MTC offset time ("MTC OFFSET").....	127
11. Setting recording Enable/Disable mode ("rEc" ENABLE/DISABLE).....	128
12. Setting a digital input channel ("dG in").....	129
13. Setting a digital output channel ("dG out").....	131
14. Setting display resolution mode On/Off ("rESoLuT").....	132
15. Setting Slave mode On/Off ("SLAVE").....	133
16. Setting MIDI device ID ("dEVicE").....	134
17. Setting the Undo function range ("Undo").....	135
MIDI Implementation Chart	136
MMC command list	137
Inquiry Message list	137
Fostex MIDI System Exclusive Message Format	138
Maintenance	148
Specifications	148
Block Diagram	150
INDEX	151

Introduction

Thank you for purchasing the Fostex Model DMT-8VL!

The DMT-8VL is an eight-track digital multitrack recorder with an integrated eight-channel analog mixer and a dedicated E-IDE type internal hard disk system.

It enables you to achieve high-quality recording/playback using a non-compression recording method, with a quantization of 16 bits and a sampling rate of 44.1kHz, which is approximately equivalent to CD quality.

The DMT-8VL incorporates many advanced functions thanks to the inclusion of a hard disk, such as copy & paste, move & paste, cut, erase (using time value or MIDI bar/beat/clock), and undo/redo.

Once standard hard disk can manage up to five programs (Program Change function), and you can record, play back, edit, and archives (save and load) each Program.

The DMT-8VL is also equipped with a jog wheel and a shuttle dial for speedy operation, a song data save/load function for use with an external DAT recorder, and an AUTO function that includes 9-point AUTO locate, AUTO return/play, and AUTO punch in/out (with rehearsal function).

The unit can also transmit MIDI clock data and Song Position Pointers via the internal programmable tempo map, and is compatible with MTC, MMC, and Fostex System Exclusive Message. You can also control and synchronize an external MIDI sequencer or sequencing software from the DMT-8VL.

Please read this Owner's Manual thoroughly and keep it in a safe place so that you will be able to produce high-definition, high tonal quality music.

Precautions

Notes about power supply

- * Be sure to connect the DMT-8VL to the power supply specified in the Specifications section of this Owner's Manual. Do not use an AC outlet of any other voltage.
- * Do not connect the DMT-8VL to the same AC outlet to which devices that could generate noise (such as a large motor or dimmer), or the devices that consume a large amount of power (such as an air conditioning system or a large electric heater) are connected.
- * If you use the unit in an area with a different power voltage, first consult your dealer or the nearest FOSTEX service station. You can use the unit with a power frequency of 50Hz or 60Hz.
- * It is very dangerous to use a power cord that is frayed or damaged. In such a case, stop using the unit immediately and ask your dealer to repair the cord.
- * To avoid possible electric shock and damage to the DMT-8VL, avoid contact with water or other liquids, or do not handle the power plug while your hands are wet.

- * To prevent possible electric shock and damage to the DMT-8VL, do not remove the main unit cover or reach the inside the unit.
- * Do not let water or other liquid, or metal objects such as pins, accidentally enter the inside of the unit because this may lead to electric shock or damage. Should water enter the inside of the unit, remove the power plug from the AC outlet, and consult your dealer or the nearest FOSTEX service station.
- * To prevent damage to the DMT-8VL, be sure to power on the connected devices first, then turn on the power to the DMT-8VL.
When you remove or connect the cables to the input/output connectors on the DMT-8VL, make sure that the channel INPUT faders and volume controls are set to "0."

Notes on handling the hard disk

- * The DMT-8VL is equipped with a high-precision hard disk. Do not expose the unit to excessive vibration at any time. In particular, do not move the unit or allow an impact to the unit when the power is on.
- * **Before turning the power off to the DMT-8VL, first quit Setup mode and make sure that the recorder section is stopped. Especially, never attempt to turn off the power to the unit while the hard disk is accessing data (the HD ACCESS LED is lit or flashing). Otherwise, not only will you lose recorded data, but you may damage to the unit. FOSTEX is not responsible for data lost during operation of the unit.**
- * Before you change the location of the DMT-8VL, pack the unit in the shipping carton or an impact-resistant case.
Make sure that the unit is kept free from external vibration or impact since the unit is very sensitive to vibration.

* If you wish to replace the included hard disk with another hard disk, refer to "Before operating the DMT-8VL" on page "41."

Notes on the setup location

- * Do not install the unit in locations subject to the following:
 - * Extremely high or low temperature, or significant changes in temperature
 - * Excessive humidity or dust
 - * Excessive changes in power supply voltage
 - * Unstable or significantly vibrating or shaking surfaces
 - * Near a strong magnetic field (such as a TV or speakers)
- * If you move the unit from a place with an excessively low temperature to a warm place, or if you use the unit in a room in which the temperature varies significantly during winter, condensation may occur on the hard disk or other parts. In such cases, leave the unit for about an hour in the new location before you turn on the power.

Notes on repair

- * This unit does not use any parts that users can repair easily. Contact your dealer or the nearest FOSTEX service station to ask about repairs.
- * Use the packing carton designed for the DMT-8VL when you transport the unit to the dealer for repair or return.
If you have discarded the packing box, try to pack the unit completely using shock absorbing materials. Fostex is not responsible for malfunction or damage due to incomplete packaging or caused during transport.

About copyrights

- * It is prohibited by law to use any part of a CD recording or video images or audio data for which copyright is possessed by a third party for commercial purposes such as contents, broadcasts, sales, or distribution - any purpose other than for your personal pleasure.

About damages

- * Fostex is not responsible for any "direct damage" or "indirect damage" caused by using the DMT-8VL.

Main Features of DMT-8vL

The DMT-8vL is equipped with the following functions:

<Recorder Section>

High-quality sound, non-compressed, eight track digital hard disk recorder

- * Instead of conventional cassette tape, the DMT-8vL is equipped with a dedicated 3.5 inch E-IDE type hard disk as the recording media, allowing for about 12 minutes (when installing the 540MB hard disk unit) or about 30 minutes (when installing the 1.3GB hard disk unit) of recording/playback.
- * Non-compression recording method, with 16-bit linear quantization and a sampling rate of 44.1kHz, which enables you to record and playback high quality sounds that are approximately equivalent to CD quality.

Managing up to five programs using the Program Change function

- * Using the Program Change function allows you to record, playback, and edit up to five songs individually on the hard disk.
In this way, you can utilize the hard disk to manage different programs at any time, without the necessity of archiving (backing up) data to an external DAT machine. (Refer to pages "36" and "50" for more details.)

Versatile editing functions are made possible by the hard disk

- * The DMT-8vL allows you to use non-linear, non-destructive audio editing functions, such as copy & paste, move & paste, cut, and erase.
These edit operations can refer not only to time values such as ABS and MIDI timecode, but to MIDI bar/beat/clock values. (Refer to page "93" for details.)
- * You need only one action to monitor the copied audio data using the Clipboard Play function. (Refer to pages "96" and "101" for details.)
- * The Over Time Monitor function lets you know the overtime length when you try to copy & paste or move & paste data in excess of the currently-available disk space. (Refer to page "31" for details.)

Undo/Redo function to support edit works

- * The Undo/Redo functions will cancel the latest edit and restore the data obtained before the edit, or restore the data obtained after the edit respectively. (Refer to pages "82, 98, 103, 106 and 107" for details.)
- * The Can't Undo function provides you with an alarm indicating that the undo area is insufficient for the Auto Punch In/Out operation. (Refer to page "31" for details.)

Song data Save/Load function

- * You can save recordings (audio data plus corresponding setup data) of each Program individually or all Programs simultaneously to an external DAT machine. You can also load a set of data to a desired Program.

The Save/Load function will take about four times as long as recording (i.e., it takes 16 minutes to save or load a four-minute song). (Refer to page "117" for more details.)

Convenient Disk Remain Display function

- * The Disk Remain function facilitates checking the available recording time. This function is compatible with all types of time references - ABS, MTC, MIDI bar, and beat.

Three types of time reference

- * The 10-digit, 7-segment display shows the current time (position) of the recorder using ABS time, MIDI timecode, or MIDI bar/beat.
- * ABS and MTC function with sub-frame precision (1/100 frame), and the MIDI bar/beat is 96 clock precision. These are used for data display and the memory register.

Various Auto functions

- * The DMT-8vL is equipped with six time memories that can be edited. Using these memories, you can perform auto locate, auto return and auto play between two points, and auto punch in/out (crossfade time: 10ms). (Refer to pages "77" and "87" for more details.)
- * Auto locate to ABS 0 or ABS END is also possible. In addition, the LOCATE key has its own memory. This is very useful for a repeated locate operation. (Refer to page "87" for more details.)
- * There are two modes for Auto Punch In/Out function: "Take" mode, which is used for actual recording, and "Rehearsal," which is used to switch the part located between the In and Out points to the input monitor. (Refer to page "77" for more details.)
- * The Pre-roll function is used to "park" a specified time prior to the locate point. Pre-roll time can be set in the range of 0 - 10 seconds. (Refer to page "124" for more details.)

MIDI function using MMC, MTC, and Fostex System Exclusive Message

- * You can add an offset of less than six hours to the ABS time value to output MTC (MIDI timecode). The MTC frame rate is compatible with all formats - 24, 25, 30DF, and 30ND. (Refer to page "126" for setting the frame rate, and to page "127" for setting the offset time.)
- * The DMT-8vL responds to MMC (MIDI Machine Control) and Fostex System Exclusive Message sent from external sequencing software. (Refer to pages "67, 70 and 137" for more details.)

Syncing multiple DMT-8vLs by the Slave Sync function

- * The Slave Sync function allows you to operate multiple DMT-8vLs in synchronization, creating more than 8 to 24-track recording system. (Refer to page "72" for more details.)

Internal programmable Tempo Map

- * The DMT-8vL is equipped with an internal programmable Tempo Map that allows the MIDI clock and Song Position Pointer to be transmitted to an external sequencer (switchable to MTC output) for complete synchronization with a hardware sequencer. You can also use Track 8 as a Metronome playback track, which will generate counts according to a Tempo Map. (Refer to pages "113" ~ "116" for more details.)
- * Eleven types of Tempo Map signature are available: 1/4, 2/4, 3/4, 4/4, 5/4, 1/8, 3/8, 5/8, 6/8, 7/8, and 8/8. Maximum 64 points of signature can be set.
- * Up to 64 points of tempo on a Tempo Map can be set on any point determined by the signature settings, in the range of 30 - 250 per quarter note. (Refer to page "114" for more details.)

Setup Menu function

- * The DMT-8vL is equipped with the following setup Menu functions for the interactive operation system. You can use a highly visible FL tube display and the jog/shuttle dial to set the parameters. (Refer to page "108" for more details.)

Main Setup Menu

LOAD (loading audio and setup data) (Refer to page "117" for details.)

SAVE (saving audio and setup data) (Refer to page "117" for details.)

FORMAT (formatting the internal hard disk) (Refer to page "123" for details.)

PREROLL (setting the Pre-roll time) (Refer to page "124" for details.)

MIDI SYNC OUT (selecting MTC, MIDI clock, or OFF) (Refer to page "125" for details.)

FRAME RATE (setting the MTC frame rate) (Refer to page "126" for details.)

MTC OFFSET (setting the MTC offset value against the ABS time) (Refer to page "127" for details.)

BAR/BEAT SET (setting the signature) (Refer to page "113" for details.)

TEMPO SET (setting the tempo) (Refer to page "114" for details.)

CLICK ON/OFF (switching the Metronome function ON/OFF) (Refer to page "116" for details.)

REC ENABLE (setting the REC ENABLE or REC DISABLE) (Refer to page "128" for details.)

dG In (selecting a digital input channel) (Refer to page "129" for details.)

dG out (selecting a digital output channel) (Refer to page "131" for details.)

rESoLu (setting Display Resolution mode ON/OFF) (Refer to page "132" for details.)

SLAvE (setting Slave mode ON/OFF) (Refer to page "133" for details.)

dEvicE (setting a device ID) (Refer to page "134" for details.)

undo (setting an effective range of the Undo function) (Refer to page "135" for details.)

Easy-to-use jog/shuttle dial

- * Using the shuttle dial allows for +/-1, 2, 3, 5, 9, 12, or 20-time speed cueing (fast-forward while monitoring audio).
- * Using the jog dial allows for digital audio scrubbing. Using this function, you can locate data efficiently while monitoring audio without any changes in pitch.
- * The jog/shuttle dial is also used to recall parameters and to enter data.

Other recorder functions

- * In addition to 30-time speed FF/REW, 5-time speed cueing (PLAY+FF/REW) is also available.
- * Connect an optional foot switch Model 8051 to the PUNCH IN/OUT connector for punch in/out (and rehearsal) operation to free your hands. (Refer to page "83" for more details.)
- * A highly visible FL-tube level meter shows the output level of Tracks 1-8 and STEREO OUT L/R.
- * The DMT-8VL can record data digitally to and from an external digital device.

<Mixer Section>

A high-quality eight-channel analog mixer that offers two microphone inputs, and mixdown of a maximum 20 channels

- * The DMT-8VL is equipped with a high-quality eight-channel analog mixer with eight inputs including two for microphones.
- * Channels 1-2 for microphones are equipped with a LEVEL switch for selecting -10dBV, -30dBV, or -50dBV, depending on the connected sound sources and microphones.
- * The stereo input monitor section allows for remixing with the main stereo L/R signal, which simulates virtual 16-channel (maximum 20-channel) mixing. (Refer to page "69" for more details.)
- * The inline monitor section allows you to select any output for the input or track. This powerful feature is very useful in various applications, such as virtual mixing of MIDI sound sources and effect pre-sending.
- * The stereo L/R output can be routed to the DATA OUT connectors (optical, S/P DIF format).

Flexible two AUX send/return

- * Each input channel has two AUX sends. Along with two stereo AUX returns, versatile effects processing is possible. (Refer to page "39" for more details.)

Other mixer functions

- * MON OUT connector and MONITOR volume for audio monitoring through the amplifier or speakers.
- * The monitor section is equipped with a selector that allows you to monitor the stereo L/R output signal and the monitor signal either individually or simultaneously.

Rear panel section (Refer to page "25" for details.)

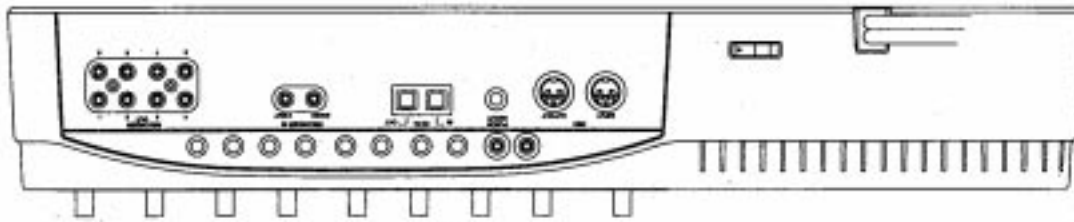

Top panel section (Refer to pages "14 - 24" for details.)

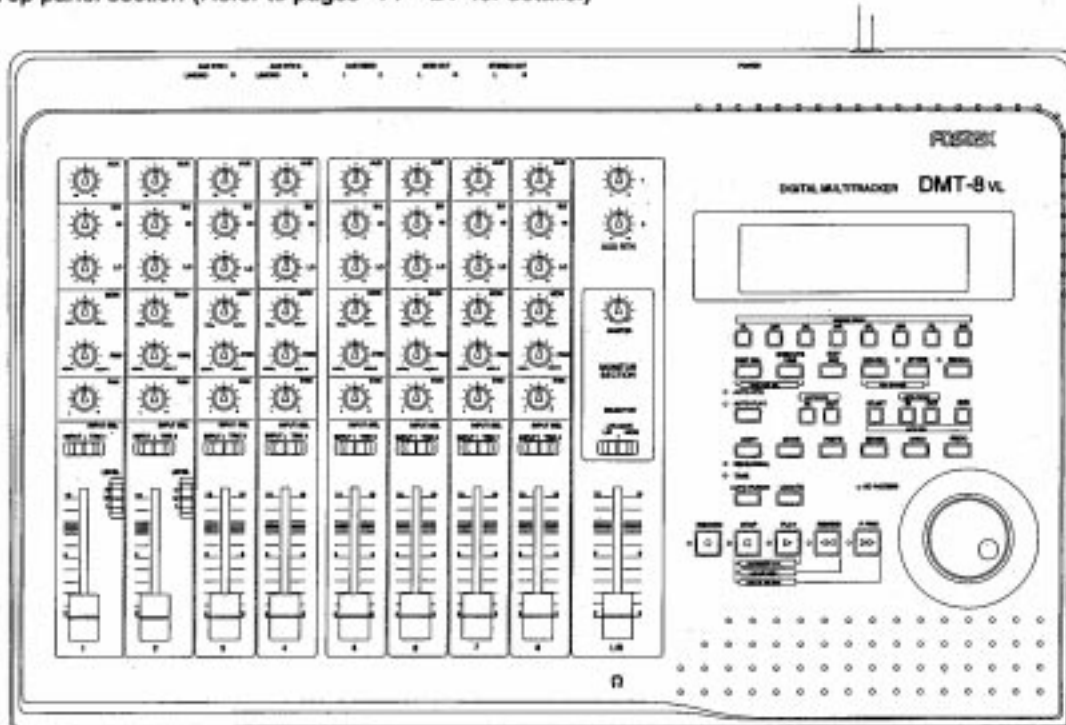

Front panel section (Refer to page "25" for details.)

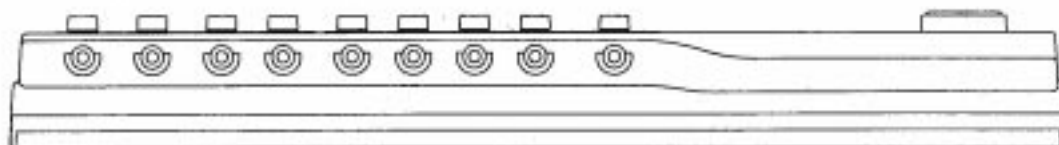

Names and Functions

<Top panel (Mixer section)>

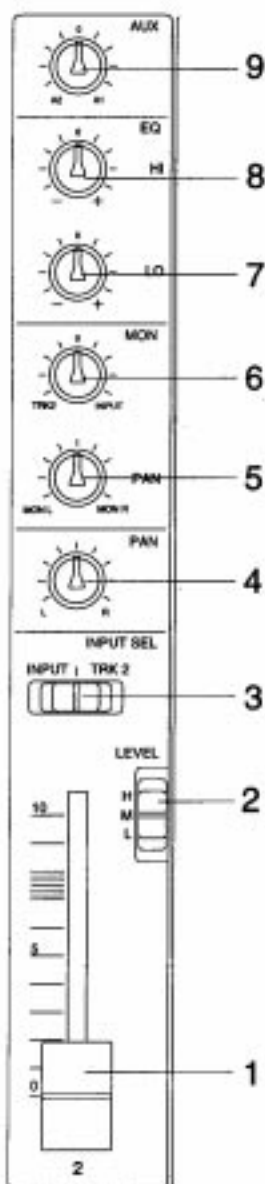

1. INPUT faders [1-8]

The INPUT faders control the input level of the signal selected via the INPUT SEL switch (that is, the input signal from the INPUT jack, or the recorder output signal). Level 7 or 8 is a standard level, and a gain of about 6dB will be obtained with level 10.

2. Input Level switches [LEVEL]

The LEVEL switches are set according to the output level of the devices connected to INPUT jacks 1-2. The option is -50dBV (L), -30dBV (M), and -10dBV (H). To connect a low output device such as a microphone, use INPUT jacks 1 and 2, which have these LEVEL switches.

<Example>

L (-50dBV)	Microphone
M (-30dBV)	Single-coil type electric guitar/bass Hum-backing type electric guitar/bass
H (-10dBV)	Keyboard, drum machine

3. Input select key [INPUT SEL (INPUT/TRK1-8)]

This switch selects the signal routed to the INPUT fader of each channel.

INPUT	Signal from an instrument or microphone connected to the INPUT jack is routed to the INPUT fader.
Center	Switch OFF (No signal will be routed.)
TRK	Recorder output signal will be routed to the INPUT fader. The track signal will be routed to the same number of the channel as the Track. For example, the Track 1 signal is routed to Channel 1, and the Track 2 signal is routed to Channel 2.

4. Panpot knob [PAN (L/R)]

This control knob has the following two functions:

- * Turn this knob all the way left or right to route the INPUT jack signals to Tracks 1-8.
- * Turn this knob to a desired position to set the stereo image of each track while mixing down.

5. Monitor Panpot knob [PAN (MON L/MON R)]

This knob adjusts the L/R balance of the signal that is selected via the MON knob and sent to the monitor section.

MON L	Signal is sent only to the left of the monitor section.
Center	Signal is sent equally to both the right and left of the monitor section.
MON R	Signal is sent only to the right of the monitor section.

6. Monitor Level Control knob [MON]

This knob allows you to select the signal that will be sent to the monitor section L/R, and adjusts the signal level.

TRK	This option selects the recorder output signal and sends it to the monitor section. Turning the control to the left will increase the level.
Center	No signal will be selected.
INPUT	This option selects the pre-fader signal from the INPUT jack and sends it to the monitor section. Turning the control to the right will increase the level.

* Pre-fader signal: The signal routed from the INPUT jack that is unaffected by the INPUT fader.

7. Low Equalizer Gain Control knob [EQ LO]

This knob is used to boost or cut the frequency of 100Hz in the range of +/-15dB.

8. High Equalizer Gain Control knob [EQ HI]

This knob is used to boost or cut the frequency of 10kHz in the range of +/-15dB.

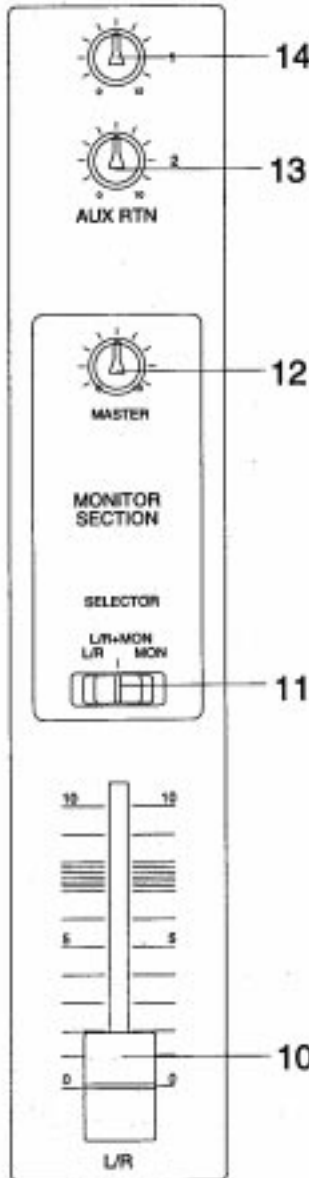

9. AUX Send knob [AUX]

This knob is used to select whether the signal at the INPUT fader is routed to the AUX SEND 1 or to the AUX SEND 2 jack, and to adjust the send level. Once selected and adjusted, the signal is sent from the AUX SEND jack to a connected external device such as an effect unit.

A1	Selecting this option will cause the signal to be routed to the AUX SEND 1 jack. Rotating the knob clockwise will increase the send level.
center	No signal will be output.
A2	Selecting this option will cause the signal to be routed to the AUX SEND 2 jack. Rotating the knob counter-clockwise will increase the send level.

10. Master fader [L/R]

This fader adjust the output signal level at the STEREO OUT L/R jacks (Stereo Bus L/R output signal). The settings will also affect the level of the signal routed to the recorder, and the output level from the monitor section.

11. Monitor selector [SELECTOR (L/R, L/R+MON, MON)]

This switch allows you to select the signal output at the MON OUT L, R, and PHONES jack.

L/R	This option selects the signal output from the STEREO OUT L/R jacks (stereo bus L/R signal).
L/R+MON	This option selects both the signal output from the STEREO OUT L/R jacks and the signal routed to the channel monitor bus L/R.
MON	This option selects the signal routed to the channel monitor bus L/R.

12. Monitor Master Level knob [MASTER]

This knob adjusts the final monitoring volume level. Using this knob will affect the level of the headphones volume and the signal output from the MON OUT jacks L/R.

13. AUX Return 2 Level control [AUX RTN 2]

This control adjusts the signal level input from an effect unit connected to the AUX RTN 2 jack. The volume level changes equally for the L and R channels.

14. AUX Return 1 Level control [AUX RTN 1]

This control adjusts the signal level input from an effect unit connected to the AUX RTN 1 jack. The volume level changes equally for the L and R channels.

<Top panel (Recorder section)>

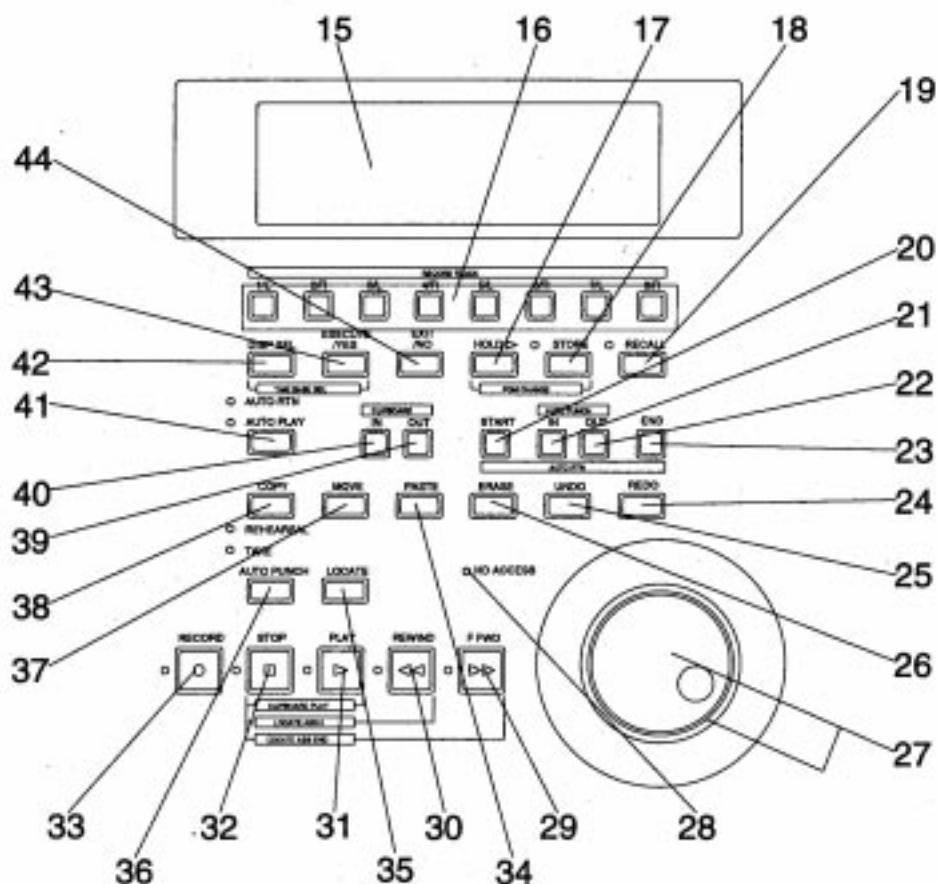

15. Meter display

This meter display shows the signal level and settings.

* Refer to the "Display section" on page "27."

16. Record Track Select key [RECORD TRACK]

The Record Track Select key selects "SAFE-READY" for the recording track. When you press this key once, the track enters the READY status, and the track indication on the display will blink. Pressing it again changes this status to "SAFE" and the track indication will go out. When you start recording, the blinking track indication becomes illuminated.

When you press only the RECORD button while the track is in the READY status, the track becomes an input monitor, allowing you to adjust the recording level. Pressing only the RECORD button again, the track become a reproduction monitor. This key is also used to select a track for the Copy & Paste, Move & Paste, Erase, or other editing operation.

* Refer to page "37" for details about the reproduction monitor and the input monitor.

17. Hold/Digit Move key [HOLD/>]

Pressing this key while the recorder transport is operating will hold the time value (or Bar/Beat/Clock value), display the value on the screen, and will place the unit into edit mode. (If you press this key while the recorder section is stopped, the DMT-8vi will enter edit mode.) Pressing this key repeatedly allows you to select the digit (column) to edit. To cancel edit mode, press the STOP button, DISP SEL key, or EXIT/NO key.

Pressing the STORE key while holding down the HOLD/> key will change a Program.

- * Refer to pages "50", "78" and "89" for more information about using this key.
- * Refer to page "45" for more information about Program Change function.

18. Store key [STORE]

This key is used to store a time value (or Bar/Beat/Clock value) to one of the memory keys. Pressing this key, then one of the following keys will cause the data shown on the display to be stored to the corresponding memory key you pressed. Pressing the STORE key while holding down the HOLD/> key will change a Program.

STORE key -> CLIPBOARD IN key	Data is stored as a Clipboard In point. The stored data can be used as a locator.
STORE key -> CLIPBOARD OUT key	Data is stored as a Clipboard Out point. The stored data can be used as a locator.
STORE key -> AUTO PUNCH IN key	Data is stored as an Auto Punch In point. The stored data can be used as a locator.
STORE key -> AUTO PUNCH OUT key	Data is stored as an Auto Punch Out point. The stored data can be used as a locator.
STORE key -> AUTO RTN START key	Data is stored as an Auto Return Start point. The stored data can be used as a locator.
STORE key -> AUTO RTN END key	Data is stored as an Auto Return End point. The stored data can be used as a locator.
STORE key -> LOCATE key	Data is stored as a LOCATE key data.

After pressing this key, if you change your mind and wish to cancel the store operation, press the EXIT/NO key, DISP SEL key, or STOP button.

- * Refer to page "93" for more information about the clipboard.
- * Refer to page "87" for more information about the Locate function.
- * Refer to page "77" for more information about Auto Punch In/Out recording.
- * Refer to page "88" for more information about Auto Return.
- * Refer to page "50" for more information about Program Change function.

19. Recall key [RECALL]

Press this key to recall the stored time value (or Bar/Beat/Clock value).

Pressing this key, then one of the following keys will display the data stored at the key you pressed, and you will be able to edit the data.

RECALL key -> CLIPBOARD IN key	The Clipboard In point is recalled and the unit enters edit mode.
RECALL key -> CLIPBOARD OUT key	The Clipboard Out point is recalled and the unit enters edit mode.
RECALL key -> AUTO PUNCH IN key	The Auto Punch In point is recalled and the unit enters edit mode.
RECALL key -> AUTO PUNCH OUT key	The Auto Punch Out point is recalled and the unit enters edit mode.
RECALL key -> AUTO RTN START key	The Auto Return Start point is recalled and the unit enters edit mode.
RECALL key -> AUTO RTN END key	The Auto Return End point is recalled and the unit enters edit mode.
RECALL key -> LOCATE key	The Locate key data is recalled and the unit enters edit mode.

To exit edit mode, press the EXIT/NO key, DISP SEL key, or STOP button.

- * Refer to page *93* for more information about the clipboard.
- * Refer to page *77* for more information about Auto Punch In/Out recording.
- * Refer to page *88* for more information about Auto Return.

20. Auto Return Start key [AUTO RTN START]

This key stores the Start point for Auto Return or Auto Repeat. Pressing the RECALL key, then this key (or pressing only this key) will display data currently stored at this key, and put the unit into Edit mode.

If you press the STORE key, then this key after editing, the edited value will be stored at this key. Data stored at this key can be used as a locator.

When you turn off the power to the DMT-8vL, the memory will be set to the factory default value.

- * Refer to page *88* for more information about Auto Return and Auto Repeat.

21. Auto Punch In key [AUTO PUNCH IN]

This key stores the Punch In point for Auto Punch In/Out recording. Pressing the RECALL key, then this key (or pressing only this key) will display data currently stored at this key, and will place the unit in Edit mode.

If you press the STORE key, then this key after editing, the edited value will be stored at this key. In addition to storing a Punch In point, this key can store the paste start point, erase start point, and cut start point. Data stored at this key can be used as a locator.

When you turn off the power to the DMT-8vL, the memory will be set to the factory default value.

- * Refer to page *77* for more information about Auto Punch In/Out recording.
- * Refer to page *93* for more information about pasting data.
- * Refer to page *93* for more information about the Erase and Cut operations.

22. Auto Punch Out key [AUTO PUNCH OUT]

This key stores the Punch Out point for Auto Punch In/Out recording. Pressing the RECALL key, then this key (or pressing only this key) will display data currently stored at this key, and will place the unit in Edit mode.

If you pressing the STORE key, then this key after editing, the edited value will be stored at this key. In addition to storing a Punch Out point, this key can store the erase end point. Data stored at this key can be used as a locator.

When you turn off the power to the DMT-8vL, the memory will be set to the factory default value.

- * Refer to page *77* for more information about Auto Punch In/Out recording.
- * Refer to page *105* for more information about the Erase operation.

23. Auto Return End key [AUTO RTN END]

This key stores the End point for Auto Return or Auto Repeat. Pressing the RECALL key, then this key (or pressing only this key) will display data currently stored at this key, and will place the unit into Edit mode.

If you press the STORE key, then this key after editing, the edited value will be stored at this key. Data stored at this key can be used as a locator.

When you turn off the power to the DMT-8vL, the memory will be set to the factory default value.

- * Refer to page *88* for more information about Auto Return and Auto Repeat.

24. Redo key [REDO]

Pressing this key after you press the UNDO key lets you to restore the status obtained before you undo recording or editing. This key is activated only when the recorder transport section is stopped.

* Refer to pages "82, 98, 103, 106 and 107" for more information about the Redo operation.

25. Undo key [UNDO]

After using an edit function such as Paste, Erase, or Cut, or after auto punch in/out recording, pressing this key will restore the previous status obtained before editing or recording. This key is activated only when the recorder transport section is stopped.

* Refer to pages "82, 98, 103, 106 and 107" for more information about the Undo operation.

26. Erase key [ERASE]

This key has two functions: the Erase function, which erases data (creates silence) within a specified region on the readied track. The other is the Cut function, which cuts data from the region beginning at the specified point. Pressing this key when all tracks are ready will activate the Cut function. Pressing this key while one or more tracks are safe will activate the Erase function.

A region to be erased is defined between the Auto Punch In point and the Auto Punch Out point. A region to be cut is defined only by the Auto Punch In point. This Cut operation requires only the start point of the region to be cut, that is, the Auto Punch In point.

Specify the area to be erased, using the Auto Punch In/Out points and the RECORD TRACK select key. To use the Cut function, set all tracks to the ready condition, and set the start point of the data to be cut as the Auto Punch In point.

This key is activated only when the recorder transport section is stopped.

* Refer to page "93" for more information about the Erase/Cut operation.

27. Jog/Shuttle dial

Jog dial (inside):

If you turn the jog dial when the recorder is stopped, you can perform jogging (forward and reverse digital audio scrubbing), without altering the audio quality. In edit mode, turning the jog dial will increase/decrease the value. In Setup mode, using the jog dial allows you to set the parameters.

Shuttle dial (outside):

The shuttle dial is used for the forward and reverse cueing at +/-1, 2, 3, 5, 9, 12, or 20 times speed. In edit mode, it is used to move around the digits.

* Refer to pages "78", "89", "94", and "99" for more information about the editing the memory data.

* Refer to page "106" for more information about Setup mode.

28. Hard disk access LED

This LED lights up or blinks when the hard disk is writing or reading data.

<CAUTION>

Do not turn the power off while the LED is lit or blinking. Otherwise, the data in the hard disk may be damaged.

29. Fast Forward button [F FWD]

Pressing this button while the recorder section is stopped will fast forward data at 30 times speed. Pressing this button in Play mode will cue data (you can hear sound during the fast forward operation) at five times speed.

Pressing this button while holding down the STOP button will initiate the "LOCATE ABS END" operation, and immediately locate the end of the recorded data on the hard disk (ABS END). (Refer to the "STOP button" section for more information about LOCATE ABS END.)

30. Rewind button [REWIND]

Pressing this button while the recorder section is stopped will rewind data at 30 times speed. Pressing this button in Play mode will cue data (you can hear sound while rewinding) at five times speed.

Pressing this button while holding down the STOP button will perform the "LOCATE ABS 0" operation, and immediately locate the beginning of the hard disk (ABS TIME: 00M:00S:00F). (Refer to the "STOP button" section for more information about LOCATE ABS 0.)

31. Play button [PLAY]

Pressing this button will start playback on the recorder section.

Pressing the RECORD button while holding down this button will start recording.

Pressing this button while holding down the STOP button will execute the Clipboard Play operation. (Refer to the "STOP button:" section for more information about the Clipboard Play operation.)

Pressing the this button during recording will stop recording (Punch Out).

32. Stop button [STOP]

Pressing this button will stop playback of the recorder section.

Pressing the PLAY, REWIND, or F FWD button while holding down this button will execute the following operation:

STOP button + PLAY button	Clipboard Play operation (The STOP LED will blink, and the PLAY LED will be lit.) *1
STOP button + REWIND button	ABS 0 will be located. *2
STOP button + F FWD button	ABS END will be located. *3

You can turn Rehearsal mode on/off by pressing the foot switch while holding down this button for Punch In/Out recording.

*1 CLIPBOARD PLAY operation

This operation plays back data copied or moved to the Clipboard. During the operation, the display will show the contents of data ("COPY" for copy data, and "MOVE" for move data) and time, and the track indicator of the copy or move source will blink, making it clear which data on which track is on the Clipboard.

*2 Locating to ABS 0 (LOCATE ABS 0):

The DMT-8vL will locate the beginning of recorded audio on the hard disk (ABS TIME: 00M 00S 00F).

*3 Locating to ABS END (LOCATE ABS END):

The DMT-8vL will locate the end of recorded audio on the hard disk (the end ABS TIME).

* Refer to page "38" of the "Before Operating the DMT-8vL" section for more information about ABS 0 and ABS END.

* Refer to page "83" for more information about Punch In/Out recording using the foot switch.

33. Record button [RECORD]

Pressing only this button places the readied tracks into input monitoring status. Pressing this button again will reset the tracks to playback monitoring. (The RECORD LED will blink when the readied tracks are under the input monitoring status.) Pressing this button while holding down the PLAY button will place the readied tracks into recording. At this time, the PLAY LED and RECORD LED will be lit, and the readied track indication will be lit steadily (instead of blinking).

* Refer to page "37" of the "Before operation the DMT-8vi." section for more information about input monitoring and reproduce monitoring.

34. Paste key [PASTE]

Press this key to copy data or move data that has been copied to the clipboard to a location stored at the AUTO PUNCH IN key. The data will be pasted at the point stored in the Auto Punch In key. You can select the paste destination track using the RECORD TRACK select key. A destination track to which data is pasted is identical to the source track.

This key is activated only when the recorder transport section is stopped.

* Refer to page "93" for more information about the Copy & Paste, and Move & Paste operation.

35. Locate key [LOCATE]

Press this key to locate a data point.

The DMT-8vi will locate the point stored in the CLIPBOARD IN/OUT key, AUTO PUNCH IN/OUT key, or AUTO RTN START/END key when you press the corresponding key and then press the LOCATE key.

The LOCATE key has a memory and stores the previously-located point.

Therefore, you only need to press this key to locate the same point repeatedly.

To check the memory of the LOCATE key, press the RECALL key, then the LOCATE key. You can also store a locate point by pressing the STORE key, then the LOCATE key after you edit data using the JOG dial and/or the HOLD/> key.

When you turn off the power to the DMT-8vi, the memory will be reset to the factory default setting.

* Refer to page "87" for more information about the Locate function.

36. Auto Punch Mode On/Off key [AUTO PUNCH]

Switch this key ON for auto punch in/out.

When you press this key while a correct value is stored to the AUTO PUNCH IN key and the AUTO PUNCH OUT key, both the REHEARSAL LED and TAKE LED will blink, indicating that Auto Punch mode is on. (If a correct value is not stored, pressing the AUTO PUNCH key will not turn the parameter ON, and the message "Void Out" will appear.)

Pressing the PLAY button under this condition will put the unit into "Rehearsal mode" for Auto Punch In/Out recording. Pressing the PLAY button and RECORD button simultaneously will put the unit into "Take mode."

There are five combinations of the REHEARSAL LED and TAKE LED that indicate the status of the unit regarding auto punch recording:

Auto Punch mode OFF	Both REHEARSAL LED and TAKE LED are off.
Auto Punch mode ON	Both REHEARSAL LED and TAKE LED are blinking.
Auto Punch Take mode	Only the TAKE LED (red) is lit.
Auto Punch Rehearsal mode	Only the REHEARSAL LED (green) is lit.
Rehearsal mode entered by means of MMC or foot switch	Only the REHEARSAL LED (green) is blinking.

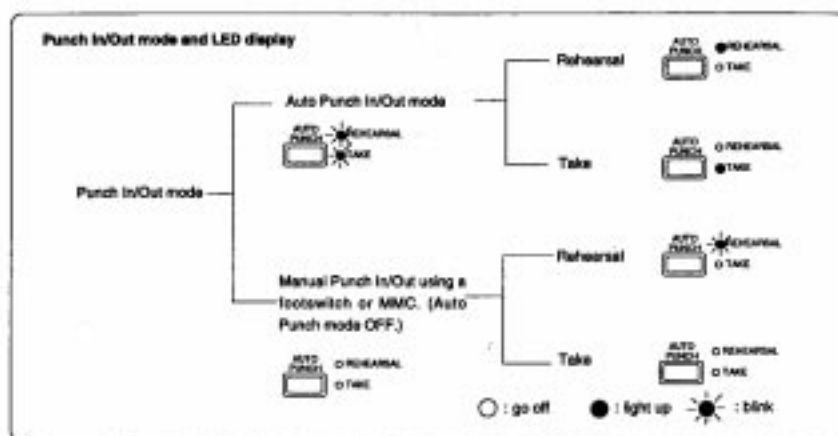

* Refer to page "76" for more information about the Punch In/Out.

37. Move key [MOVE]

This key is used to enter into the clipboard data stored in memory by the CLIPBOARD IN/OUT keys. Pressing the MOVE key will store the data in the Clipboard as Move data. To enter data to be moved, one or more tracks must be readied, and a correct value must be stored for the In and Out points.

If you attempt to enter data when all tracks are safe, all track indications and "SELECT trk" indication on the display will blink to warn you. If a correct value is not set for the Clipboard In or Out, a warning message of "Void In" or "Void Out" will appear.

* Refer to page "93" for more information about the Copy & Paste, and Move & Paste operation.

38. Copy key [COPY]

This key is used to copy data stored in the memory using the CLIPBOARD IN/OUT keys. Pressing the COPY key will store the data in the Clipboard as Copy data.

To execute the copy operation, one or more tracks must be readied, and a correct value must be stored for the In and Out points. If you attempt to copy data when all tracks are safe, all track indications and a "SELECT trk" indication on the display will blink to warn you. If a correct value is not set for the Clipboard In or Out points, "Void out" warning will appear.

* Refer to page "93" for more information about copying data.

39. Clipboard Out key [CLIPBOARD OUT]

When audio data is copied or moved, the end point of the copied part is stored in the memory. Pressing this key following the RECALL key (or pressing only this key) will show the stored data on the display and the recording section enters edit mode. In edit mode, use the HOLD/> key or shuttle dial to move around the digits, and use the jog dial to increase/decrease the value.

If you press this key following the STORE key after the edit operation, the edit value will be stored into the key memory. The data stored by this key can be used as locate data. When you turn the power to the DMT-8VL, the memory will be reset to the factory default setting.

* Refer to pages "95 and 100" for locating the CLIPBOARD OUT point.
* Refer to page "93" for copying/moving data.

40. Clipboard In key [CLIPBOARD IN]

When audio data is copied or moved, the start point of the copied part is stored in memory. Pressing this key following the RECALL key (or pressing only this key) will show the stored data on the display and the recording section will enter edit mode. In edit mode, use the HOLD/> key or shuttle dial to move around the digits, and use the jog dial to increase/decrease the value.

If you press this key following the STORE key after the edit operation, the edited value will be stored into the key memory.

The data stored by this key can be used to locate data.

This memory is reset to the factory default value when the power is turned off.

* Refer to page "93" for copying/moving data.
 * Refer to pages "94 and 99" for locating the CLIPBOARD IN point.

41. Auto Play/Auto Return key [AUTO PLAY/AUTO RTN]

Pressing this key repeatedly will change Auto Play mode, Auto Return mode, and Repeat mode On/Off as follows: (○: LED off, ●: LED light up)

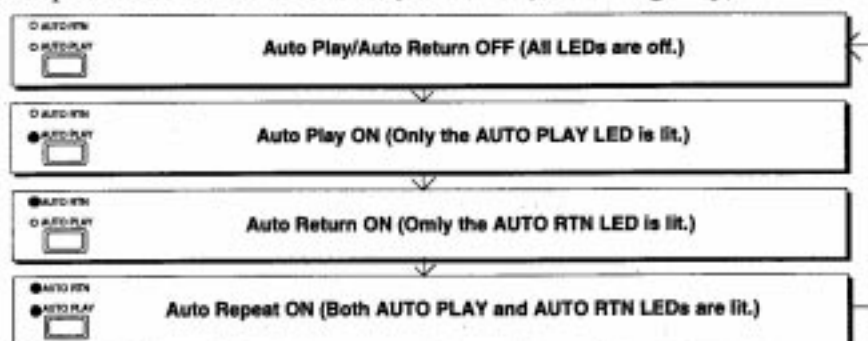

Auto Play mode:

In this mode, playback will start automatically after the START point is located. This function is effective at any locate points other than the ABS END point.

Auto Return mode:

When the END point is reached during playback, the START point is automatically located in this mode. This function is effective only when the START and END points have been specified.

<Note>
 Auto Return function is effective only during playback. In recording mode, the START point will not be located automatically when the END point is reached.

Auto Repeat mode:

This mode is a combination of Auto Play and Auto Return, and plays back the part between the START and END points repeatedly. The auto repeat function is effective only when the START and END points have been specified correctly.

* Refer to page "87" for details.

42. Display Select key [DISP SEL]

This key is used to change the display mode. Pressing this key repeatedly will change the display mode as follows:

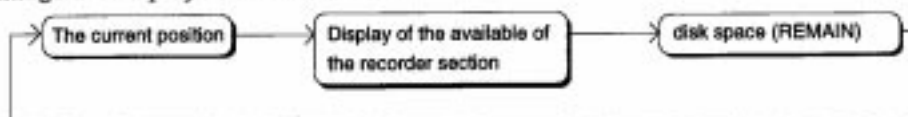

* Refer to page "28" for more information about the REMAIN.
* Refer to page "108" for more information about the SETUP mode.

Pressing this key while holding down the EXECUTE/YES key will switch the Time Base (*) as follows. The Time Base can be set when the display shows the recorder's current position or the available disk space (REMAIN).



(*) Time Base:

The DMT-8vL uses time display (ABS or MTC) or Bar/Beat/Clock display to indicate the current position of the recorder section. These displays are called "Time Base." ABS (Absolute Time) shows the absolute time of the disk, and MTC (MIDI Timecode) shows the relative time obtained by adding an MTC offset value to the ABS value. Bar/Beat/Clock (BAR/ / CLK) indicates a position within a piece of music and conforms to the MIDI clock and Song Position Pointers created on the internal Tempo Map.

* Refer to pages "114", "125" and "127" for more information about MTC and the internal Tempo Map.
* Refer to page "38" for more information about Time Base.

43. Execute/Yes key [EXECUTE/YES]

Press this key to execute the operation when you try to edit data on the hard disk using the edit functions such as Paste and Erase, when you put the DMT-8vL into SETUP mode, or when you set the parameters in the SETUP menu.

Pressing the DISP SEL key while holding down the EXECUTE/YES key allows you to select the Time Base. (Refer to the explanation about the DISP SEL key.)

* Refer to page "93" for more information about using this key for the Paste or Erase operation.
* Refer to page "108" for more information about using this key in SETUP mode.

44. Exit key/No key [EXIT/NO]

Contrary to the EXECUTE/YES key, this key is used to stop the operation.

* Refer to page "93" for more information about using this key for the Paste or Erase operation.
* Refer to page "108" for more information about using this key in SETUP mode.

<Front panel (I/O connections)>

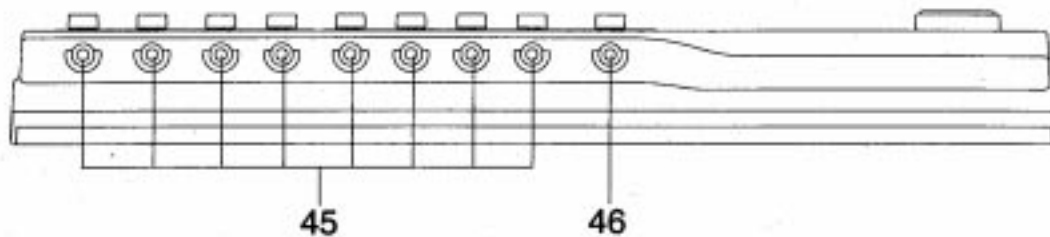

45. Input jack [INPUT 1-8] (Connector: PHONE jack)

Connect your sound source, such as musical instruments and/or microphones, to these inputs. Connect the microphone to INPUTs 1-2. These inputs are equipped with the LEVEL switch that allows you to switch the input level according to the output level of the connected microphone.

46. Headphones connector (Connector: Stereo PHONE jack)

Connect the headphones to this jack. You can control the headphones volume using the MASTER knob in the monitor section.

<Rear panel (I/O connections)>

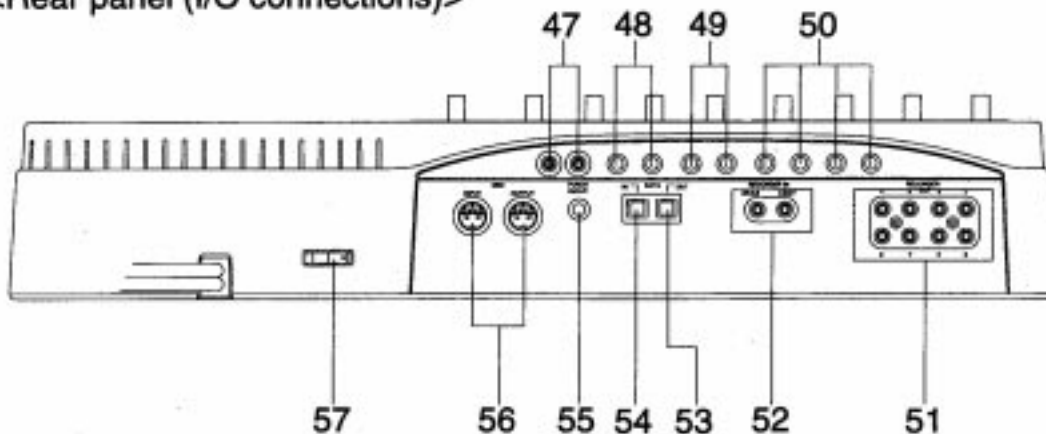

47. Stereo Out L, R jacks [STEREO OUT L,R] (Connector: RCA pin jack)

Connect the INPUT jack of the master recorder here. These jacks output the stereo bus L, R signal. Use the master faders L/R to adjust the output level.

48. Monitor Out jacks [MON OUT L, R] (Connector: PHONE jack)

Connect monitoring amplifier and speakers, or powered speakers here. These jacks output the signal selected via the SELECTOR switch in the monitor section, that is, the stereo bus L, R signal or the monitor bus L, R signal. Use the MASTER knob in the monitor section to adjust the output level.

49. AUX Send 1, 2 jacks [AUX SEND 1,2] (Connector: PHONE jack)

Connect these jacks to the INPUT jacks on the effect unit. The signal selected and level-adjusted by the AUX Send1 knob or AUX Send2 knob will be sent to the effect unit.

50. AUX Return 1, 2 jacks [AUX RTN 1, 2, L/MONO, R] (Connector: PHONE jack)

Connect these jacks to the OUTPUT jacks on the effect unit. These jacks can be also used as auxiliary inputs. If the effect unit has MONO output, use the L/MONO jack. The jack R will receive the same signal. Use the AUX RTN knobs 1, 2 to adjust the input level.

51. Recorder Out jacks [RECORDER OUT 1-8] (Connector: RCA pin jack)

These analog connectors are used to output the recorder Track 1-8 signal directly. When you are using the DMT-8vL as a dedicated recorder, connect these jacks to the INPUT jacks of the external mixing console.

* Refer to page "74" for more information on using the DMT-8vL as a dedicated recorder.

52. Recorder In jack [RECORDER IN 2/4/6/8, 1/3/5/7] (Connector: RCA pin jack)

These connectors are used to route the external signal directly to the recorder section of the DMT-8vL when you are using only the recorder section of the unit. The signal will be sent to four tracks simultaneously. Input signal at RECORDER IN 1/3/5/7 is routed to Tracks 1/3/5/7; input signal at 2/4/6/8 is routed to Tracks 2/4/6/8. Connect the OUTPUT jack of the external mixing console here.

<Note>

When you connect the plug into one of the DMT-8vL's RECORDER IN jack, the Master faders L/R will be disabled for recording, since the connected device has priority. If you wish to use the DMT-8vL's mixer function for recording, make sure that you remove any plugs from the RECORDER IN jacks.

* Refer to page "77" for more information on using the DMT-8vL as a dedicated recorder.

53. Data Output connector [DATA OUT] (Connector: OPTICAL)

Use this connector to connect and save DMT-8vL data to a DAT machine. This connector is also used to record digital data from the DMT-8vL to an external digital device.

* Refer to page "117" for more information about saving data.

* Refer to pages "62 and 64" for more information about digital recording.

54. Data Input connector [DATA IN] (Connector: OPTICAL)

Use this connector to load song data (audio + setup data) stored on a DAT machine to the DMT-8vL. You can also use this for digital recording from an external digital device, such as a CD player or a MD player, to the DMT-8vL.

* Refer to page "117" for more information about loading song data.

* Refer to pages "62 and 64" for more information about digital recording.

55. Punch In/Out jack [PUNCH IN/OUT] (Connector: STEREO PHONE jack)

Connecting an optional foot switch will let you control punch in/out (and rehearsal) recording. Use the Fostex Model 8051 foot switch.

* Refer to page "83" for information about punch in/out recording using a foot switch.

56. MIDI IN/OUT connectors [MIDI INPUT/OUTPUT] (Connector: DIN 5-pin)

MIDI INPUT:

Connect the MIDI OUT connector from an external MIDI device here. Sending the MMC (MIDI Machine Control) commands or FEX (Fostex System Exclusive messages) allows you to control the DMT-8vL remotely.

MIDI OUTPUT:

Connect the MIDI IN connector on the external MIDI device here. This connector will output MTC (MIDI timecode), MMC (MIDI Machine Control) response, MIDI clock signal, and FEX (Fostex System Exclusive messages).

57. Power switch

This switch turns the main power to the DMT-8vL on/off.

<Warning>

Before turning off the power to the DMT-8vL, be sure to quit SETUP mode and make sure that the unit is in stop mode. Do not turn off the power while the DMT-8vL is accessing the hard disk (when the HD ACCESS LED is lit or blinking). Otherwise, recorded data may be lost forever.

<Display section>

The display of the DMT-8vL integrates the level meter of a high-visibility FL tube with a time display of 10 digits and 7 segments.

The level meter shows the Track 1-8 output level of the recorder section and the stereo L/R output of the mixer section simultaneously. The time display shows the current time of the recorder section using ABS TIME (Absolute time), MTC (MIDI timecode), or MIDI BAR/BEAT (bar/beat). This display also shows the messages required for interactive operation. The following section explains the display functions and provides with some examples.

1. Display shown when the power is turned on

When you turn on the power to the DMT-8vL, the display shows "in it il," "wait" (Initializing. Please wait.), and the time display shows the time using the time base (ABS, MTC, or BAR/BEAT/CLK) that was selected before the power was turned off.

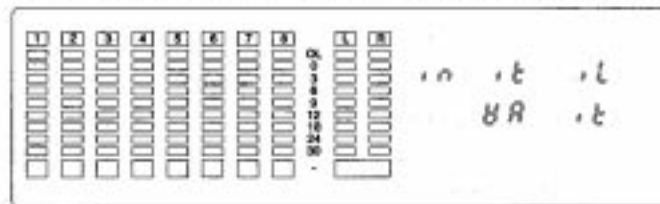
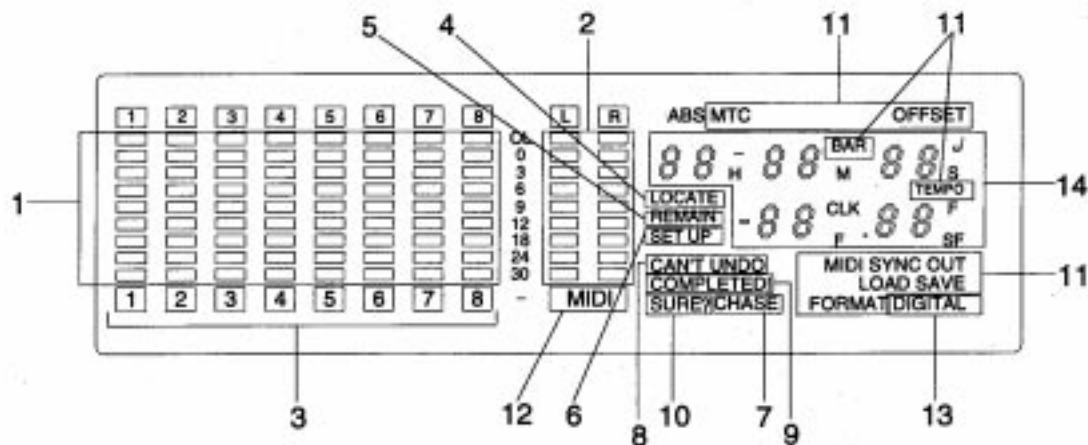
**2. Preset display****1. Level meter 1**

The level meter shows the recorder output level and the recording level for Tracks 1-8.

2. Level meter 2

The level meter shows the Stereo Out L/R output level of the mixer section.

3. Track indication

The track indication blinks when the corresponding track is ready. It turns off when the track is safe, and is lit during recording.

4. LOCATE

This appears when the DMT-8vL enters edit mode, telling you that pressing the LOCATE key will cause the point to be located.

5. REMAIN

Refer to "2. Switching the display using the DISP SEL key."

6. SETUP

Refer to "2. Switching the display using the DISP SEL key."

7. CHASE

This message flashes when the "Slave mode" in the setup mode is set to "ON." It will light up when the lock operation is complete.

8. CAN'T UNDO

If you try to perform Auto Punch In/Out recording after the DMT-8vL enters Auto Punch In/Out mode, this message appears to warn you that you will be unable to undo the recording even if you can record, because there is not enough Undo area on the disk.

9. COMPLETED!

This message indicates that an operation such as copy, move, and paste has been completed.

10. SURE?

This message is shown to confirm whether or not you wish to execute a certain operation.

11. LOAD, SAVE, FORMAT, MTC OFFSET, FRAME RATE, MIDI SYNC OUT, TEMPO, BAR,

When the DMT-8vL enters Setup mode, the preceding words appear as names for the parameters being set.

12. MIDI

This indication lights up when the DMT-8vL receives effective MIDI messages from an external MIDI device.

13. DIGITAL

This indication lights up when the DMT-8vL is receiving a digital signal properly at the DATA IN connector while loading data from a DAT machine. If this indication is blinking, the digital signal is not being received correctly.

14. 7-segment Display

This display shows the ABS time, MTC time, BAR/BEAT/CLK, and Program number.

3. Switching the display using the DISP SEL key.

Let's assume that you turned off the power while the time display was using a time base of "ABS," and then you turned the power on again. The DMT-8vL time display will again use a time base of "ABS." (Underline->Displayed program number)

ABS TIME display

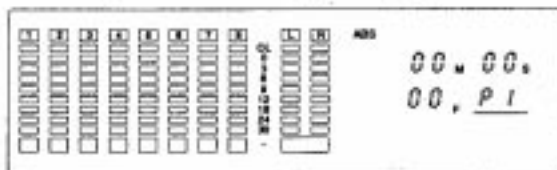

At this time if you press the DISP SEL key, the Disk Remain display (available recording time on the recorder) will appear.

DISK REMAIN display

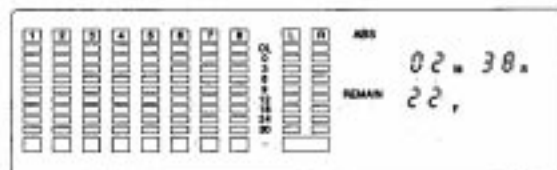

If "BAR/J/CLK" is selected for the timebase (explained later), the DISK REMAIN indication will show a value (in terms of the number of measures) calculated based on the last beat/tempo data on the tempo map of the recorded song.

When you press the DISP SEL key again, the Setup mode display will appear. At this time, the DMT-8vL has not entered Setup mode. To put the DMT-8vL into Setup mode, press the EXECUTE/YES key. After pressing the EXECUTE/YES key, if you wish to go back to the previous status, press the EXIT/NO key.

Setup mode display

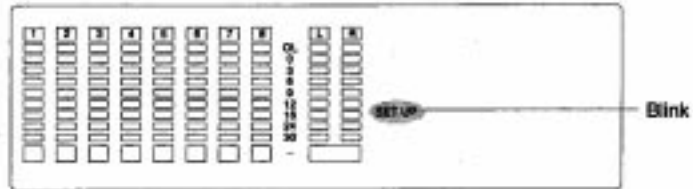

When you press the DISP SEL key again, the screen returns to the "ABS TIME" display.

4. Switching the Time Base display using the EXECUTE/YES key and DISP SEL key

When the screen is showing the ABS TIME or REMAIN display, if you press the DISP SEL key repeatedly while holding down the EXECUTE/YES key, the TIME BASE display will change cyclically. You can select one of the following Time Base displays.

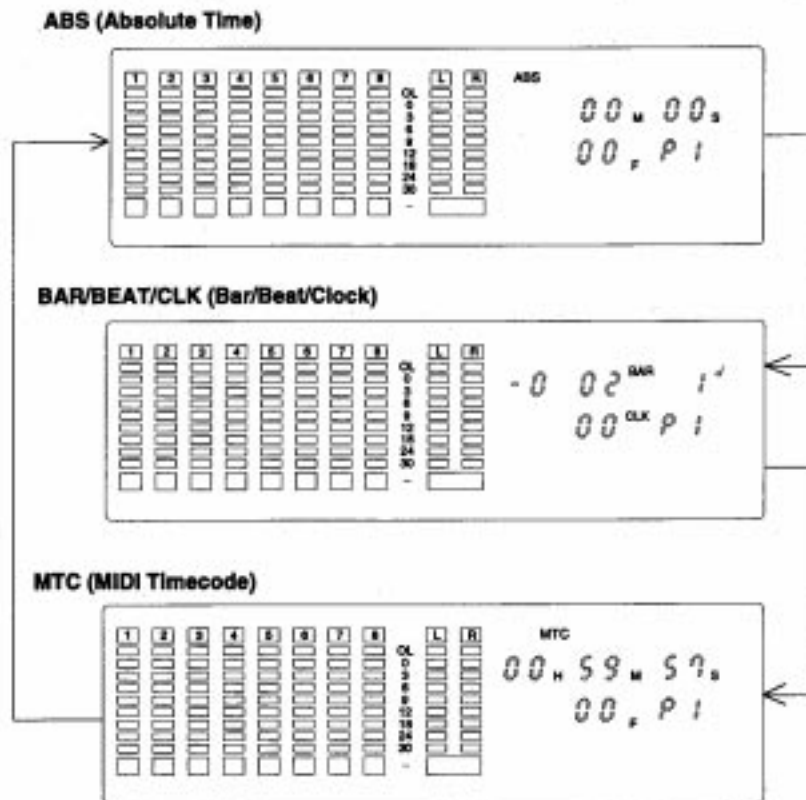

5. Changing Programs using the STORE key and the HOLD/> key

The Program Change function allows you to select any of five Programs (1-5) to which the hard disk space is allotted, so you can record, playback, edit, and archive up to five songs individually on a single hard disk (as long as there is adequate free space on the disk). You can create an individual song, so that example the first song is in Program 1, the second song in Program 2 etc.

To perform recording, playback, edit, and archive, first select a desired Program.

Press the STORE key while pressing and holding down the HOLD/> key and repeatedly will select from Program 1 to Program 5. Each Program automatically selects the Time Base (ABS, MTC, or BAR/BEAT/CLK) that was used before you previously turned the power off. The following diagram shows how the Program number with the corresponding Time Base is displayed. If you operate the JOG dial while the Program number with the ABS or MTC Time Base is displayed, the Program indication will change to the sub-frame indication. However, using the transport buttons or the SHUTTLE dial will switch back to the Program number indication. (When the BAR/BEAT/CLK display is used, the Program number indication will not change.)

<Note>

You can record data of up to about 12 minutes (when installing the 540MB hard disk unit) in total in Program 1 to 5. For example, if you have recorded 10 minutes of data in Program 1, you can record a total of 2 minutes of data in Program 2-5. Check the REMAIN display while recording.

Program number with the ABS Time Base (ex: Program P1)

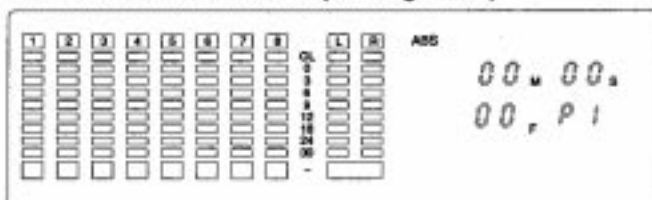

Program number with the BAR/BEAT/CLK indication (ex: Program P3)

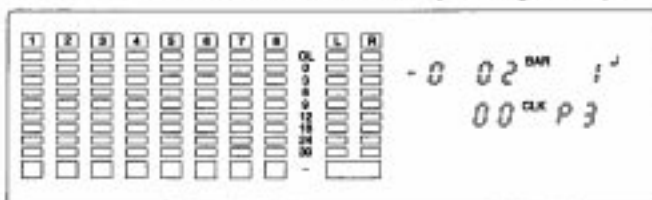

Program number with the MTC Time Base (ex: Program P5)

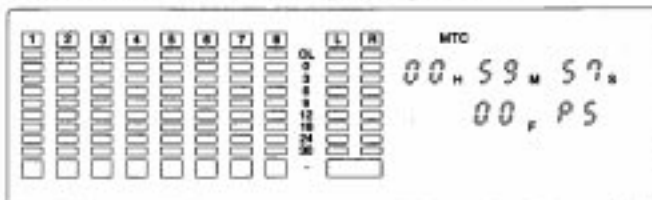

6. Warning messages

The following warning messages appears automatically when you operate the DMT-8VL incorrectly, input invalid or improper data, or when their errors occur:

Invalid data indication (The input data is not appropriate for the operation).

Action to take:

Input correct data.

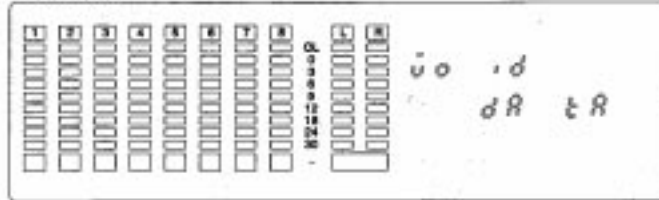

Invalid In/Out indication (The In or Out points is not appropriate for the operation).

Action to take:

Input correct data.

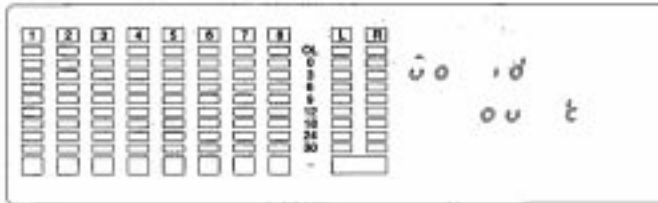
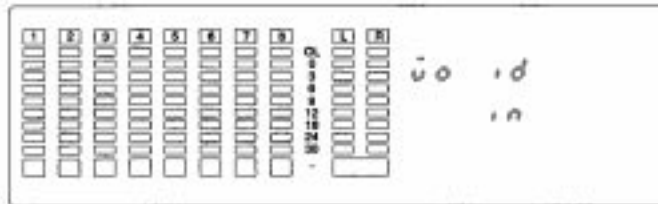

Overtime indication (The available disk space is insufficient for the length of time (the number of measures) indicated on the display.)

Action to take:

During the copy & paste and move & paste operation, try to shorten the length of the copied data by the indicated amount. Alternatively, use the "CUT" function to move the ABS END point backward to obtain enough disk space for editing.

During Auto Punch In/Out mode, shorten the length of data between the In and Out points, or move the ABS END point backward.

If this warning message appears when you start Auto Punch In/Out mode, the message will automatically disappear and the display will show the next message "CAN'T UNDO." This message means that if you try to punch in record, you will be able to record but unable to undo the recording due to insufficient undo space on the disk. If you wish to see the overtime indication again, press the AUTO PUNCH IN/OUT key again.

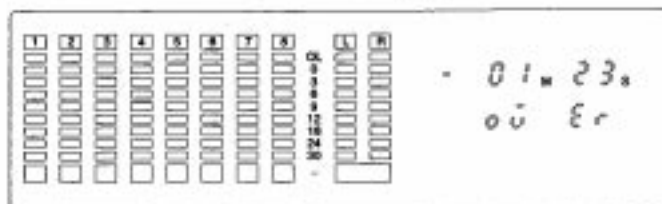

Unassigned track indication (Select any track)

Action to take:

Use the RECORD TRACK select key to ready any track.

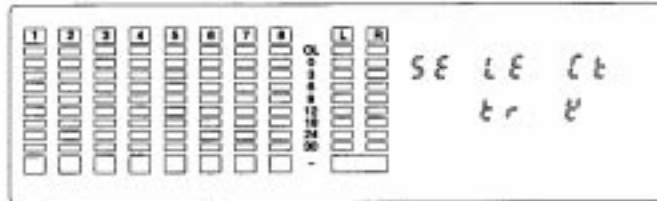

Event overflow indication (The editing points are overflowed)

Action to take:

You edited too much. The warning means "you cannot paste or erase any more." In this case, first use the "SAVE" function from the Setup mode to save data to an external DAT machine, then load the data back to the DMT-8VL. In this way, the editing points will be cleared and you will be able to continue editing.

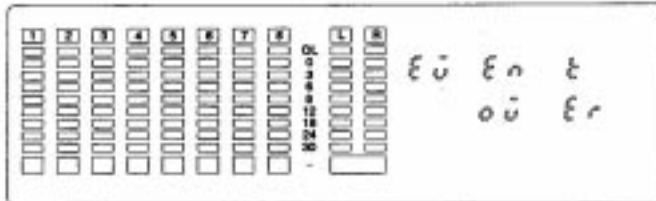

Load error indication (You cannot load data because the data input to the DATA IN connector contains an error)

Action to take:

Check to see if there is an abnormality with the external DAT machine connected to the DATA IN connector or with the DAT type itself. Try to "LOAD" again.

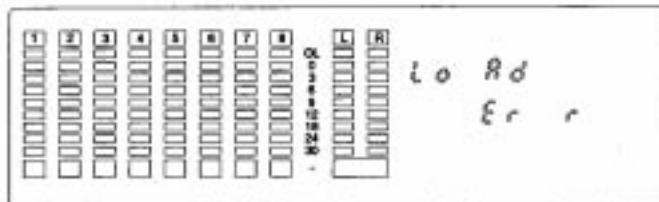

Un-formatted indication (The internal hard disk is damaged or not formatted yet.)

After this message is shown for about 10 seconds, "FORMAT" in Setup mode will flash on the display. Pressing the EXECUTE/YES key at this moment will erase all data and reformat the hard disk.

Action to take:

Press the EXECUTE/YES key to format the disk. (All audio and other data on the disk will be lost.)

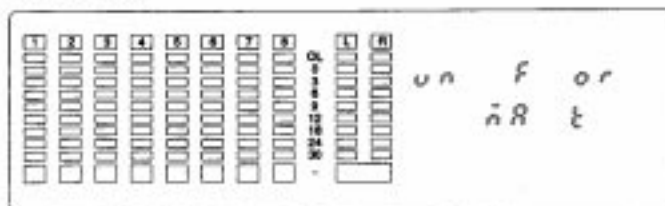

Disk error indication (This disk cannot be read)

Action to take:

Contact the Fostex service station as soon as possible.

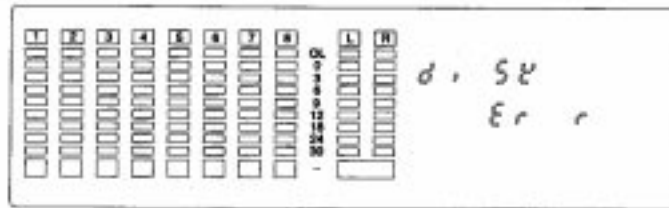

Error indication (Internal error occurred)

Action to take:

Stop the operation, and inform the Fostex service station of the error message number.

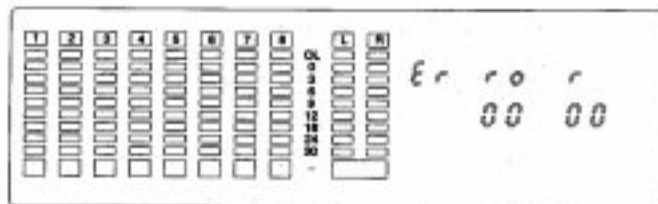

Before Operating the DMT-8VL

This section includes the following items that you need to know before operating the DMT-8VL:

1. Layout of the DMT-8VL top panel
2. Difference between track and channel
3. Function of the PAN knob and about stereo bus
4. Difference from a tape MTR
5. Input monitor and playback monitor
6. Time Base
7. Connecting an effect unit
8. Installing the hard disk

1. Layout of the DMT-8VL top panel

The DMT-8VL is a digital multitrack recorder that combines a mixer and a recorder, as shown below. All the switches, knobs, and faders on the top panel are categorized into the following sections, each of which has dedicated functions. Now that you have learned the functions of the knobs and switches in the previous section "Names and Functions," take a look at the layout of these parts on the entire top panel to learn their location.

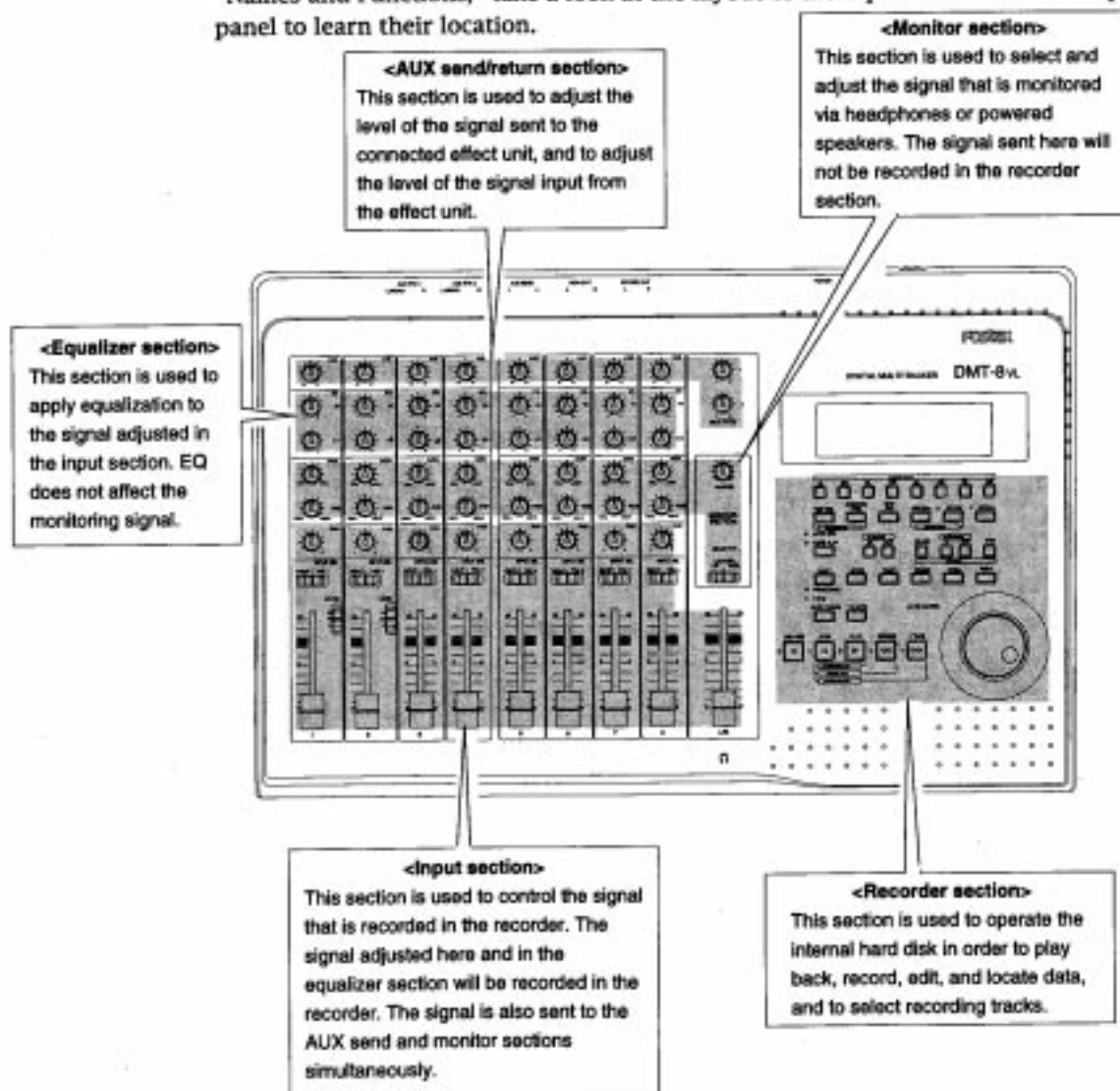

2. Difference between track and channel

The terms "track" and "channel" can sometimes be confusing. In this manual, they are differentiated as follows:

Channel:

"Channel" is used to define the input and output system on the mixer section (e.g., the bass signal routed to Channel 1 is output from Channel L.)

Track:

"Track" is used to define the input and output system in the recorder section (that is, the hard disk on the DMT-8VL) e.g., Ping-pong record playback signal on Track 1, 2, and 3 to Track 4.

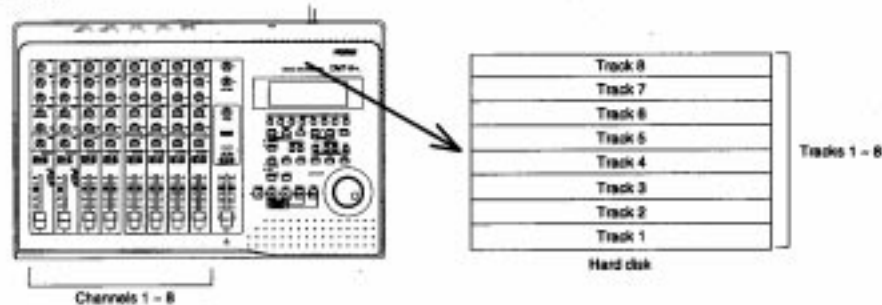

3. Function of the PAN knob and about the stereo bus

The DMT-8VL has a built-in 8-channel mixer that allows you to mix down eight sound sources into a stereo signal. The mixer functions and the flow of signal are not visible, but refer to the diagram below to understand the signal flow inside the DMT-8VL. The thick pipe in the diagram is called the "stereo bus," which collects the signals that have passed through the channel PAN knobs. Then, the signal is adjusted for the final level via the Master faders L/R, then output from the STEREO OUT L/R jacks, and recorded to the recorder.

The PAN knobs function as a direction indicator for the stereo bus. That is, rotating the PAN knob to the L side will send the signal to the stereo bus L, and rotating it to the R side will send the signal to the stereo bus R. Setting the PAN knob in the center position will send the same signal to the stereo bus L and R equally. The signal from the stereo bus is also sent to the recorder section. As the following diagram shows, the L output is sent to Tracks 1, 3, 5, and 7, and the R output is sent to Tracks 2, 4, 6, and 8 simultaneously. You can select recording tracks using the RECORD TRACK select key. For example, if you wish to record channel 1-8 signals to Track 1, turn the RECORD TRACK select key "1/L" ON, then fully rotate the PAN knob of all channels to the L side.

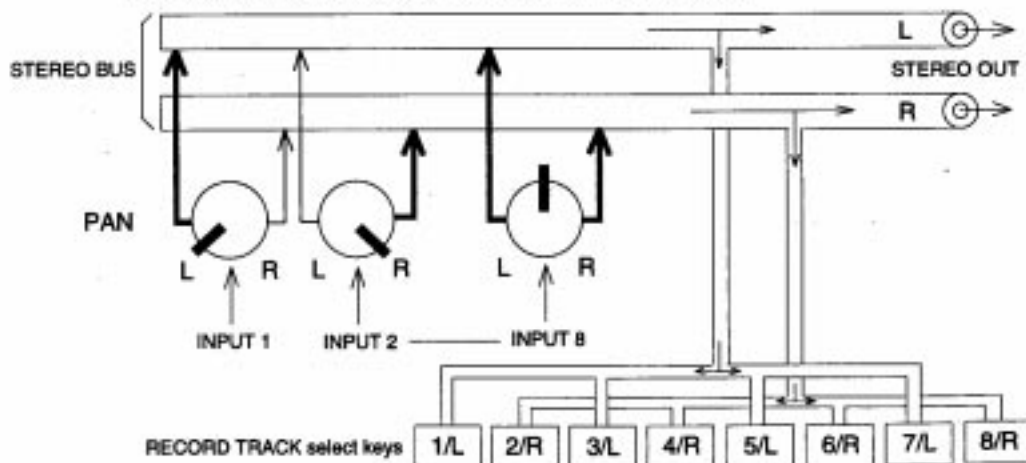

4. The difference between a tape-based multitracker and a hard disk multitracker

The DMT-8vL uses a hard disk as the recording media. Recording and playing back data on the DMT-8vL is slightly different than on a conventional tape-based multitracker.

On a tape-based multitracker, you can play the tape from any point between the beginning and the end of the tape as shown below. However, hard disk recording allows you to play between the ABS time (absolute time) - that is, "0", and the "END" point. (The end point represents the end of the recording.) You could make the analogy that the DMT-8vL has a built-in tape with a maximum duration of 12-minutes (when installing the 540MB hard disk unit). If you made a five-minute recording, you would work with a five-minute tape; if you recorded one additional minute, it would be like using a six-minute tape.

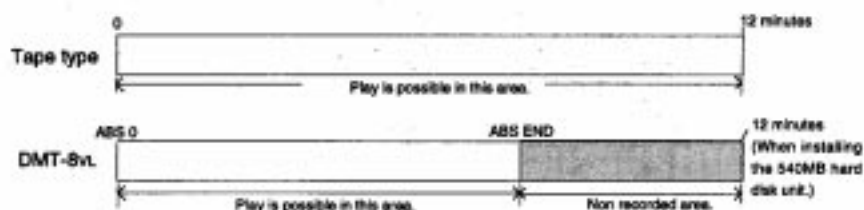

The Program Change function of the DMT-8vL allows you to record and edit up to five songs individually on the built-in hard disk. This can be described with the analogy of individual rooms as shown below, where you can record, play back, and edit in each room without giving any influence to the other rooms.



One of the important things here is that the total recording time for five Programs is 12 minutes using the standard built-in hard disk. (If you replace the hard disk, the total time would be the maximum recording time of the new hard disk.) That is, if you record 12-minutes (when installing the 540MB hard disk unit) of data in one Program, you cannot record any more data in the other Programs. (If each song is three-minutes long, you can record each song in five Programs.)

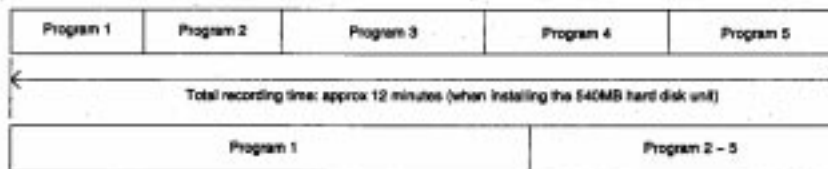

* Refer to the "Recording/playback" section for how to use the Program Change function.

5. Input monitor and Repro monitor

There are two ways to monitor track data on the recorder: Input monitor and Repro monitor. These are defined as follows:

Input monitor:

Input monitoring enables you to listen to the input signal that is routed to and output through the tracks just as it is. That is, listening to (monitoring) the post-recorder input signal (not the pre recorder signal). Eight tracks on the DMT-8VL can be set to either "Input monitoring" or "Repro monitoring" status. Follow the steps below to set the tracks to Input monitor.

1. Set the track to recording status.

To set the track to recording status, first ready the track, then press the PLAY button while holding down the RECORD button. At this time, the recording track is in Input monitoring status.

Alternatively,

2. Ready the track, and press the RECORD button once. (If you press the RECORD button again, the track enters the repro monitoring status.)

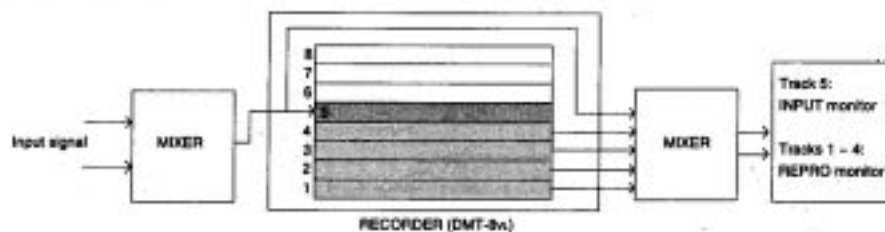
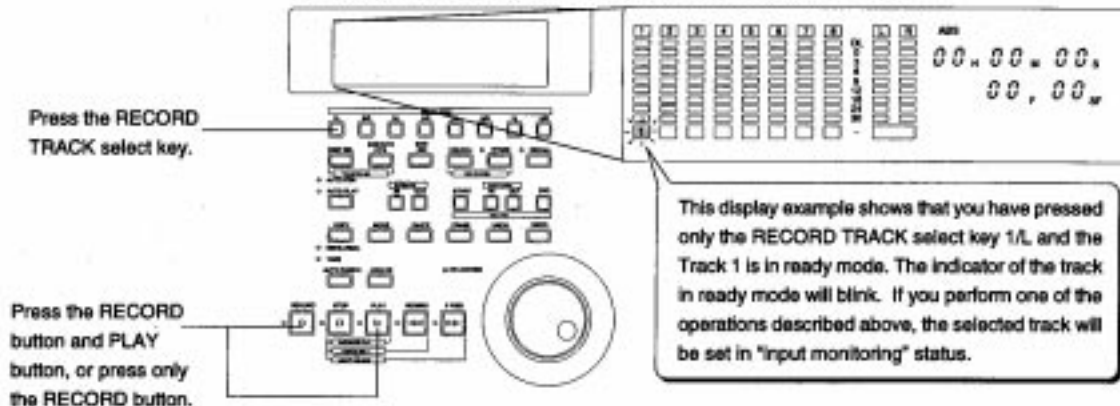

* At this time, the RECORD LED next to the RECORD button will flash, and the currently selected tracks will enter input monitoring status.

Repro monitor:

Repro monitoring enables you to monitor the playback signal on the tracks; that is, to listen to the output of the recorded signal.

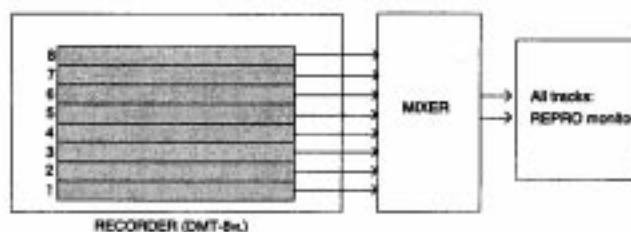

6. Time Base

The DMT-8vL indicates the location of the recorder (the current position) using the ABS time, MTC, or MIDI Bar/Beat/Clock. This time reference is called "timebase." ABS (Absolute Time) refers to an absolute time on the hard disk; MTC (MIDI timecode) refers to a relative time obtained by adding a certain value (MTC offset value) to the ABS value; and BAR/BEAT/CLK (bar/beat/clock) indicates a position in a song that corresponds to the MIDI Clock/Song Position Pointer and can be created using the internal Tempo Map. (The following diagram shows the relationship between the three types of timebase.)

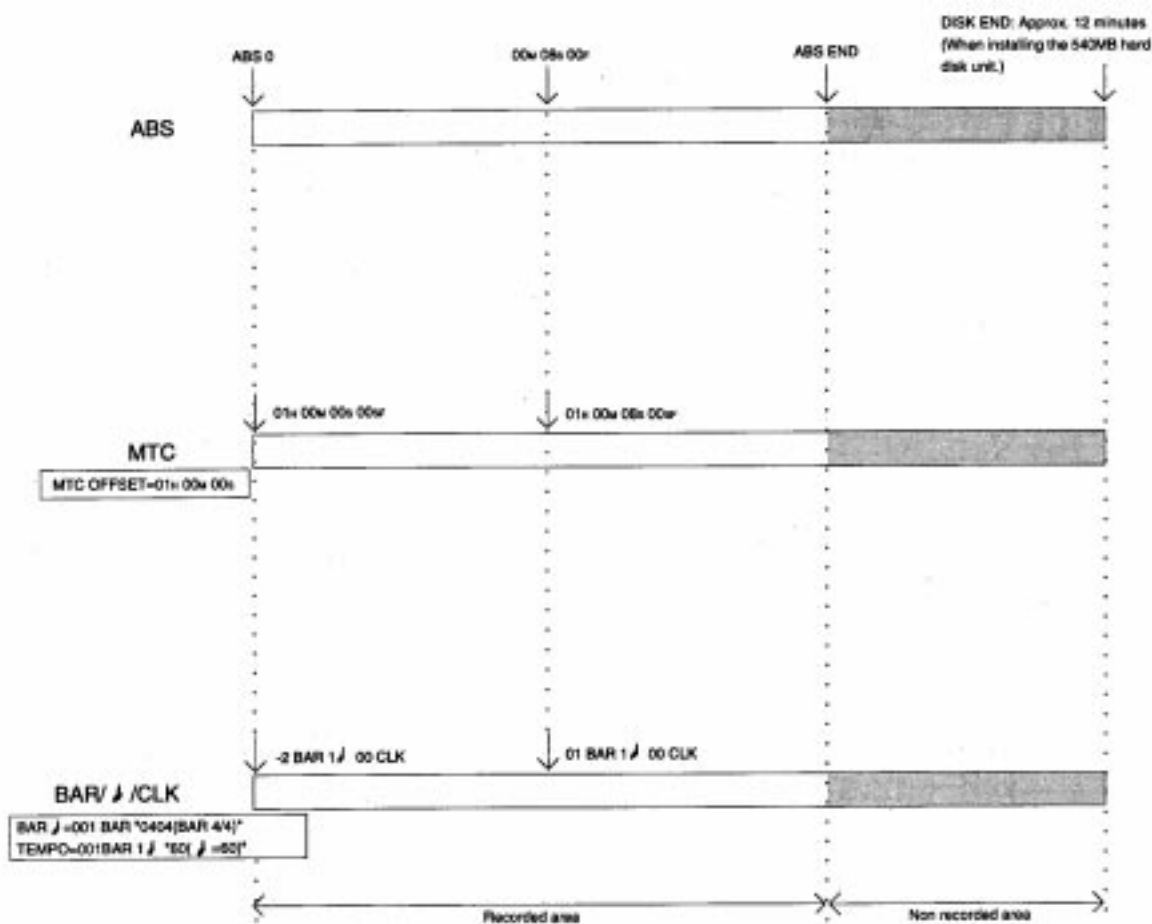

7. Effect Connection

The DMT-8vL is equipped with two sets of AUX send (mono-out) and AUX return (stereo-in), allowing two effect units with mono-in/stereo-out to be connected. (See the figure below.)

If the effect unit has a mono output, use the L/MONO connector of the AUX RTN 1 and AUX RTN 2 jacks. (When the effect unit is connected to the L/MONO jack, the same signal is input to the right channel.)

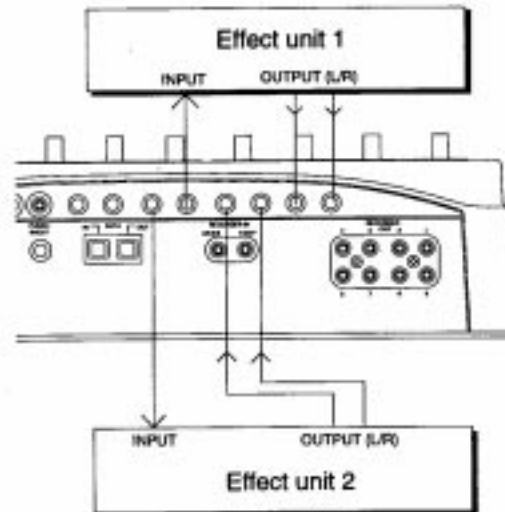

<Signal flow>

The connected effect unit receives the signal that is routed to the DMT-8vL's INPUT faders.

As shown in the diagram below, use the INPUT SEL switch to select the signal input to the INPUT jack or the signal output from the recorder to route it to the INPUT fader.

This signal is adjusted for the level via the INPUT fader, then processed by the equalizer, routed to AUX SEND 1 or AUX SEND 2 (depending on the setting of the AUX send knob) and sent to the connected effect unit. For example, if you wish to apply effect to the signal input at the INPUT jack, set the INPUT SEL switch to "INPUT."

If you wish to apply an effect to the recorder output signal (playback signal), set the INPUT SEL switch to "TRK." The signal is output from the effect unit and returned to the AUX RTN jack of the DMT-8vL, then level-adjusted via the AUX RTN knob, and finally sent to the recorder section (or the STEREO OUT L/R jacks) and the monitor section.

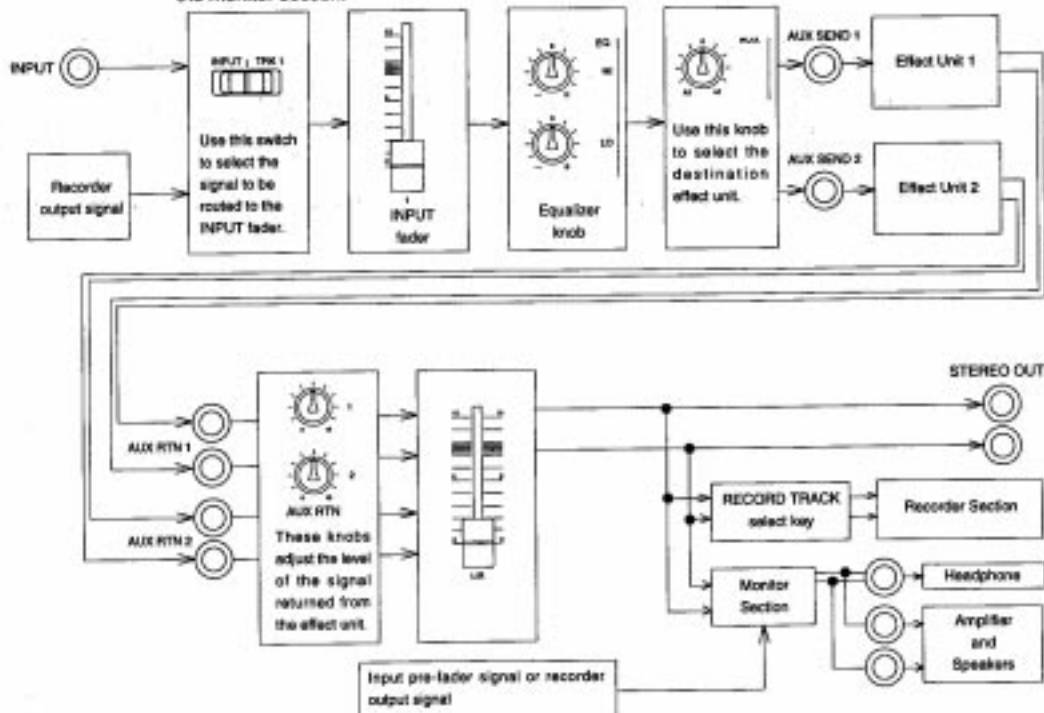

<Hint>

The previous section "Effect Connection" explained how to connect a mono-in/stereo-out effect unit. If you wish to connect a stereo-in/stereo-out effect unit, refer to the following diagram:

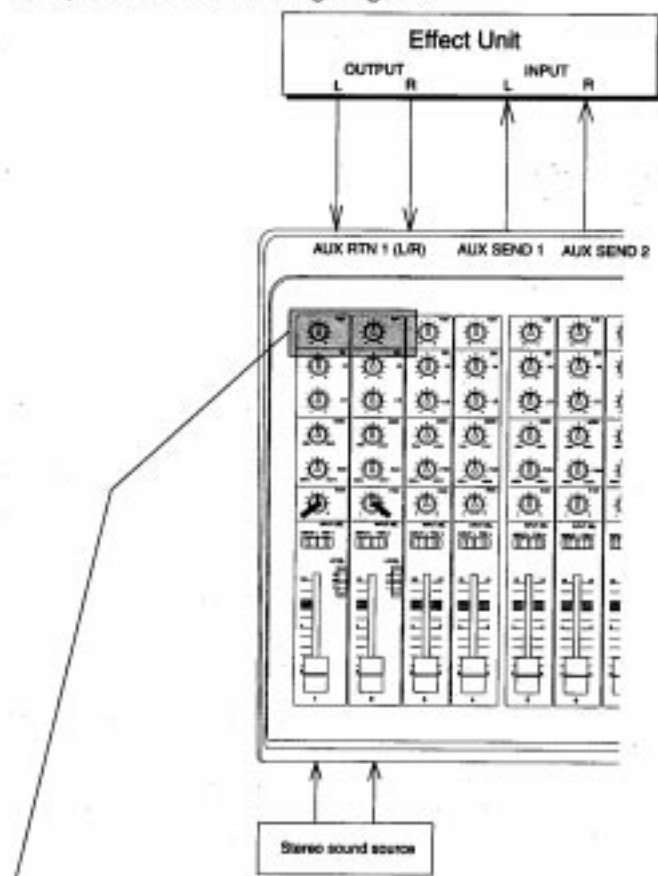

As shown in this diagram, connect the DMT-8vL's AUX SEND 1 and 2 to the INPUT L/R jacks of the effect unit. For example, if you wish to input a stereo sound source at INPUT jacks 1 and 2 and apply an effect to this stereo signal, turn Channel 1 AUX send knob to "A1," and turn Channel 2 AUX send knob to "A2" to route the signal to the effect unit.

8. Installing the hard disk

A 3.5-inch E-IDE type removable hard disk unit can be installed in the DMT-8VL. In accordance to the requirement, various hard disk units can also be installed. Please select the hard disk which can be installed in the DMT-8VL from the following list. Please follow precautions below for correct installing.

<Precaution for replacing the hard disk - 1>

Before replacing the hard disk, be sure to turn off the power to the unit and remove the power plug from the AC outlet. If the hard disk contains important data, first back up the data to a DAT machine so that you will not lose it in case of an unexpected accident or failure. Do not allow anything to impact the hard disk, and avoid strong magnetic fields.

<Precaution for replacing the hard disk - 2>

Wear gloves when you replace the hard disk.

Customers are not expected to touch the bottom part of the unit, and the bottom is not designed to prevent injury.

Therefore, if you touch the bottom panel with your bare hand while replacing the hard disk, you may be injured. Be sure to follow the correct procedure and pay careful attention to avoid injury.

List of hard disks proven to work with the DMT-8VL.

Recommended hard disk list (as of August, 1996): All disks conform to the ATA (IDE) standards.

Manufacturer	Model name	Capacity	Recording time
Quantum	Fireball	540MB	Approx. 12.5 minutes
Quantum	Fireball	1.08GB	Approx. 25 minutes
Quantum	Fireball II	640MB	Approx. 15 minutes
Quantum	Fireball II	1.28GB	Approx. 30 minutes
Quantum	Trailblazer	850MB	Approx. 18 minutes
Quantum	Sirocco	1.7GB	Approx. 40 minutes
Quantum	Sirocco	2.55GB	Approx. 60 minutes
Quantum	Tempest	1.28GB	Approx. 30 minutes
Quantum	Tempest	2.55GB	Approx. 60 minutes
IBM	Diskstar	540MB	Approx. 12.5 minutes
IBM	DPEA-31080	1.08GB	Approx. 25 minutes
IBM	DJAA-31700	1.71GB	Approx. 40 minutes
Conner	CFA1275A	1.275GB	Approx. 30 minutes
Western Digital	WDAC31600	1.6GB	Approx. 38 minutes
Maxtor	71626RP	1.6GB	Approx. 38 minutes

<Note>

The hard disks not listed above may reduce the performance of the DMT-8VL (for example, shortened recording time).

The DMT-8VL will work with any ATA (IDE) standard hard disks from the manufacturers listed above with a capacity of 500M Byte or more for both sides and a speed of 4,500 rpm or higher.

Installing the hard disk unit (newly)

<CAUTION>

Do not apply strong impact to the hard disks nor leave them in a strong magnetic field. Hard disks are precision devices. Handle them very carefully.
Fostex is not responsible for any malfunction or damage caused by incorrect handling.

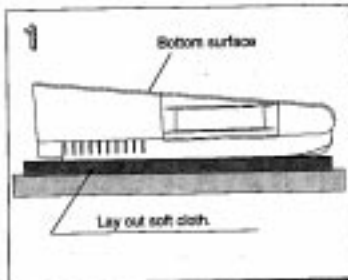

1 Remove a DMT-8VL power plug of the DMT-8VL from the AC outlet, and place the unit with the bottom panel facing up on a soft cloth on the level surface so that the unit will not be scratched.

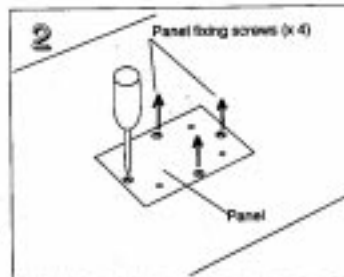

2 First loosen then remove the screws (4 holes). Do not lose these screws as they will be used later.

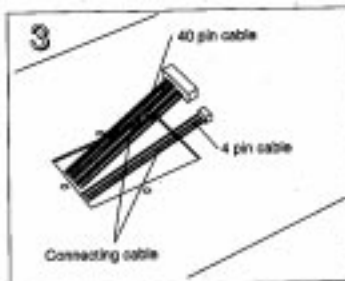

3 If the panel only (with no disk unit installed) is removed, two cables will be fixed inside with adhesive tape. Remove the tape and pull out the cables through the hole as shown in the schematic (Be careful not to pull too hard on the cables).

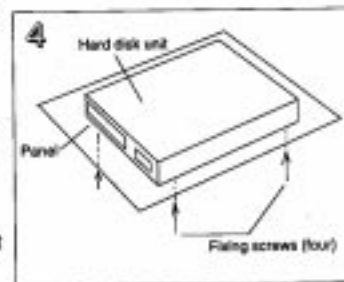

4 The hard disk unit is mounted on the panel removed from bottom of DMT-8VL in above Step 2. For fixing on the panel, use the "Hard disk unit fixing screws" included with DMT-8VL.

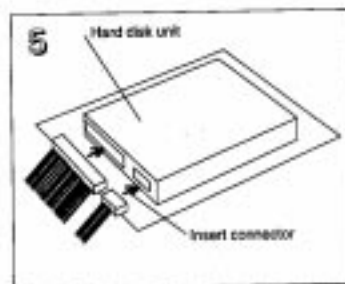

5 Insert the cable plugs into the 40 pin and 4 pin connectors on the another hard disk unit. (Be careful to note direction/shape of the plugs and firmly insert them in the receptacles).

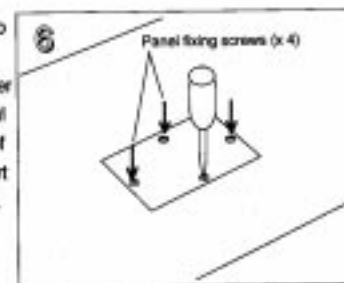

6 Upon correctly connecting the cables, place the hard disk unit in its designated position and complete installation by fixing it with the previously removed screws. During this process, be careful not to pinch the cable with the panel.

<Precaution at fixing on the panel>

When fixing the hard disk unit on the panel, face the side on which the printed circuit card (the side on which various IC is installed) of the hard disk unit is mounted, toward the panel.
Refer to schematic at right.

The side where no IC's can be seen.

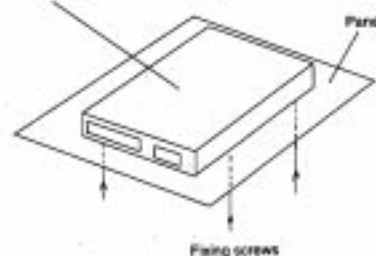

Follow the procedure on the page 44 to format the disk.

Replacing the another hard disk unit

The following is procedure on replacing the hard disk unit.

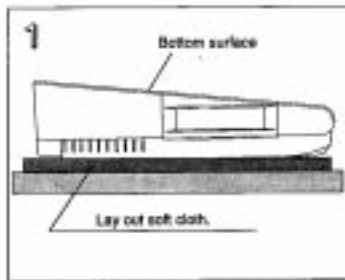

Remove a DMT-8vL power plug from the AC outlet, and place the unit with the bottom panel facing up on a soft cloth on the level surface so that the unit will not be scratched.

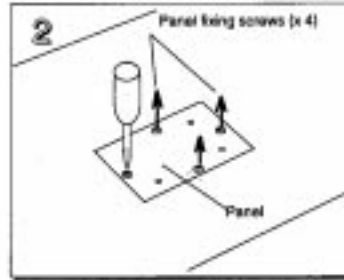

Remove the four panel fixing screws from the bottom panel.

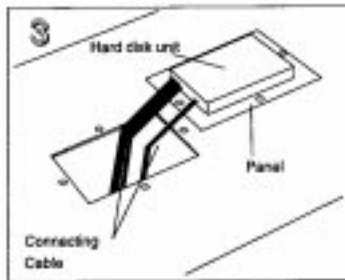

Using both hands, lift the panel that is attached to the hard disk. Do not pull too strongly on the two connecting cables.

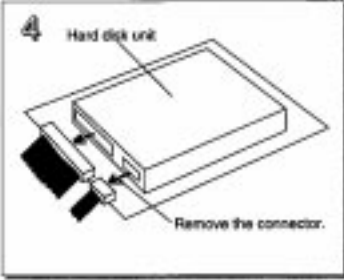

Remove the cables (40-pin cable and 4-pin cable) that are connected to the hard disk unit.

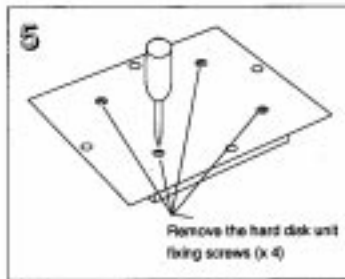

Position the hard disk and panel upside down so that the panel is now facing up, and remove the hard disk unit fixing screws to detach the hard disk from the panel.

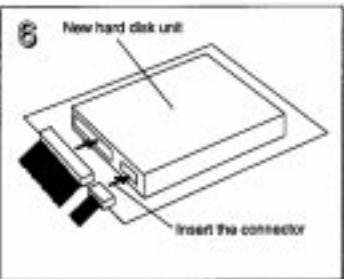

Follow in the reverse steps to remove the parts in order to fix the new hard disk unit to the panel using the screws. Then insert the cables to the corresponding connectors. Make sure that the cables are connected securely.

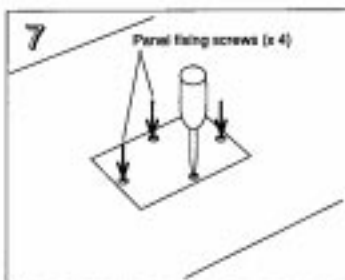

Fix the panel that is attached to the hard disk onto the bottom panel of the unit. Make sure that the cables are not pinched between the panels.

Follow the procedure on the next page to format the disk.

Formatting a hard disk

After installing or replacing the hard disk unit, follow this procedure to format the disk. When you turn the power on to a DMT-8vL that has an unformatted disk, the unit automatically enters Setup "FORMAT" mode.

1. Turn on the power to the DMT-8vL.

The display will show the initial screen, then change to the following screen:

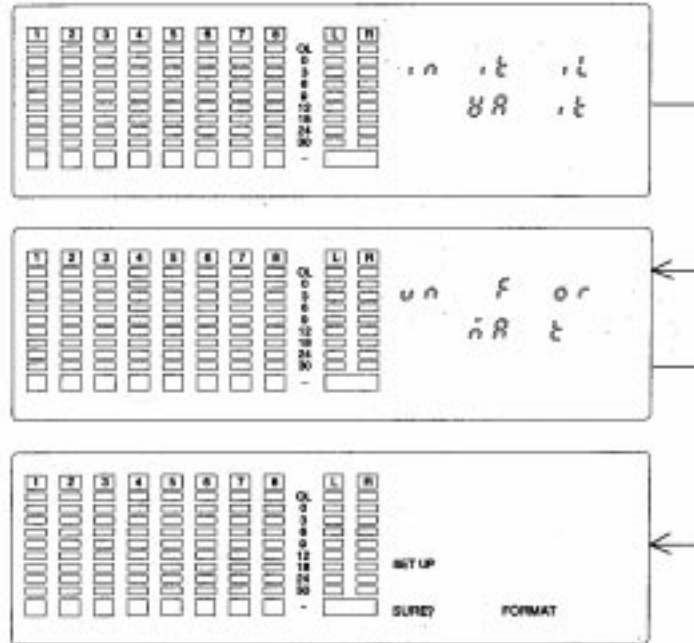

2. Press the EXECUTE/YES key.

The display will change to the following screen, and formatting will start. The display will show the time required for the formatting operation as a negative value, and count down.

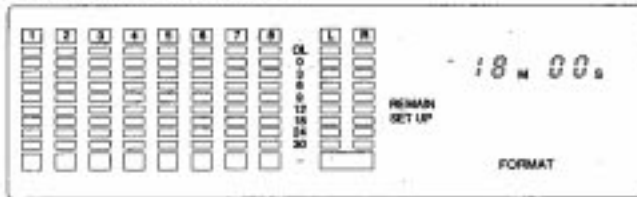

When formatting is complete, the following screen will appear, and the hard disk will stop.

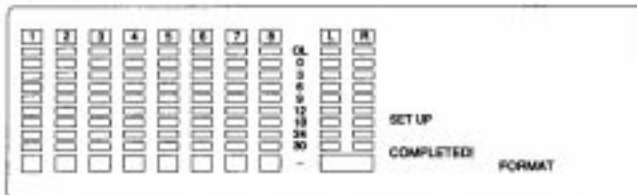

3. Press the EXIT/NO key or the STOP button to quit Setup mode.

* If you are using a hard disk that already contains some data from when it was used in a computer, the DMT-8vL may not enter formatting mode automatically. In this case, press the DISP SEL key to force the unit to enter Setup mode, then select "FORMAT" to format the disk. (See page "123" for more information on "FORMAT" in Setup mode.)

Recording/Playback (Basic Guide)

This section explains basic recording and playback on the DMT-8VL.

To become familiar with the operation of the DMT-8VL, please read and comprehend this basic section before proceeding to advanced operations.

1. The default settings on the DMT-8VL

Before you start operating the DMT-8VL or proceed to the next step, you may want to arrange the controls and switches to restore the basic settings. This setting is called "default setting" in this manual. As default settings, the controls and switches should be arranged as shown in the figure below.

Remember to make it a rule to return to these default settings before you proceed to a new step.

Default settings:

1. All the INPUT faders and Stereo Master faders should be lowered to the minimum.
2. Set Channel 1 & 2 LEVEL switches to "H (-10dBV)."
3. All controls and switches should be in the center position "0" or "0."
4. Turn all the RECORD TRACK select keys to "SAFE (OFF)."
5. Turn all the operation/setting keys to "OFF." (The LEDs should be off.)

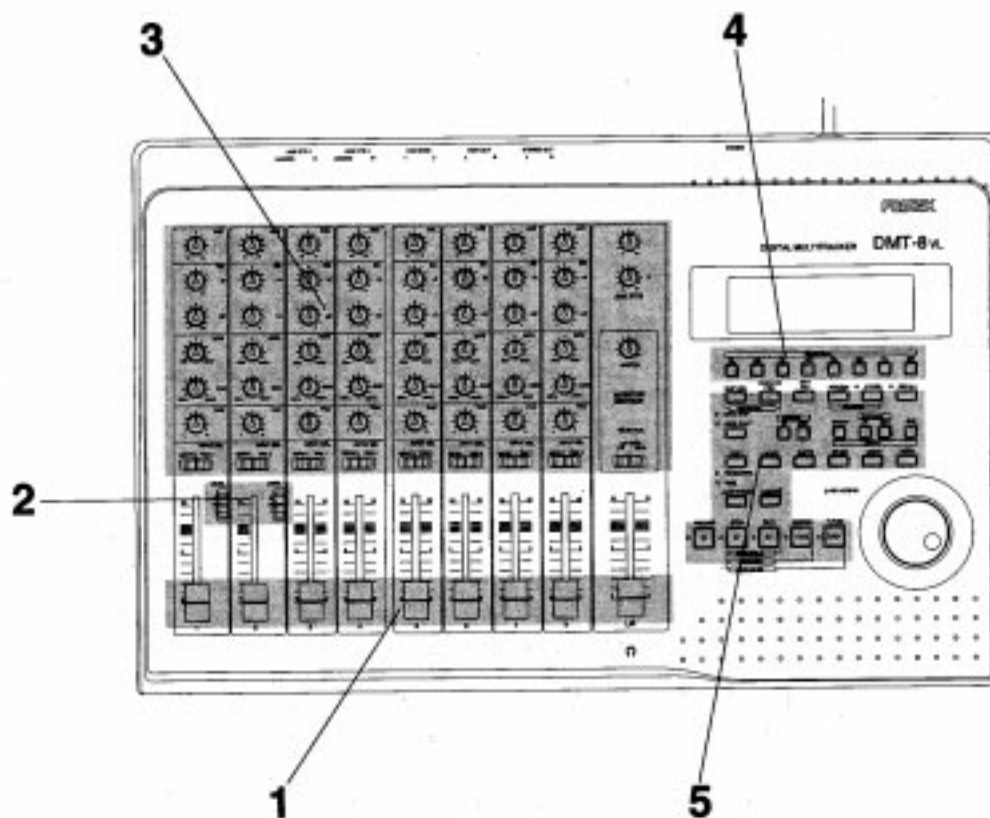

2. Basic analog data recording (before starting multitrack recording)

Before you start eight-track recording, first try to record one sound source to one track. This is very basic recording. Any sound source will do. Here, as an example, we are going to connect an electric guitar to INPUT jack 1 to record the guitar sound to Track 1 in Program 1 ("P1"). If you wish to record in another Program, refer to the section "Recording while using the Program Change function (Switching Programs 1-5)."

- * First, set the DMT-8vL to the default settings.
- * Turn the power on to the DMT-8vL, and confirm that the display Time Base is "ABS" "00M 00S 00F" and that Program P1 is selected.

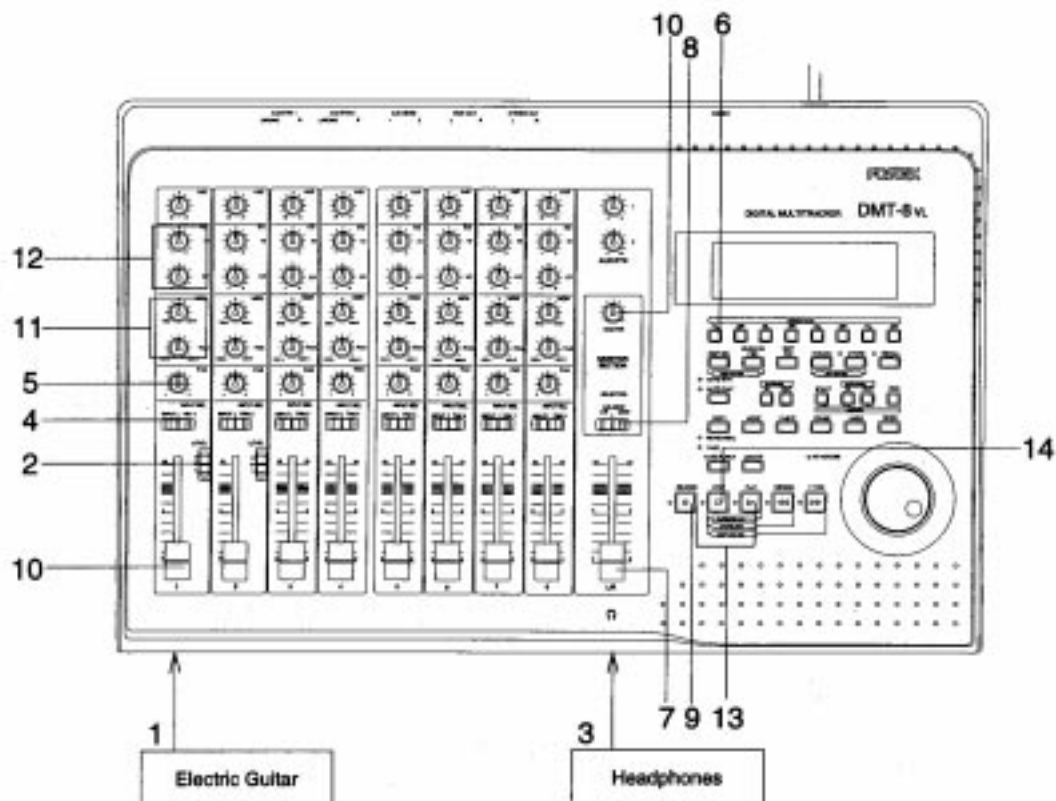

Connecting the sound source and headphones

1. Connect an electric guitar to INPUT jack 1.
2. Set the LEVEL switch to "H (-10dBV)." (This position will be adjusted later.)
3. Make sure that the MASTER control in the monitor section is set to "0" and connect the monitoring headphones to the PHONES jack.

Setting the switches / controls

4. Turn the INPUT SEL switch to "INPUT."
The electric guitar signal will be routed to the INPUT fader.
5. Turn the PAN control knob all the way to "L" (counter-clockwise).
The electric guitar signal will be routed to the stereo bus L.
6. Press the RECORD TRACK select key "1/L" to ready Track 1. ("1" on the display will blink.)

Adjusting the recording level

- 7. Raise the Master faders L/R to 7-8.**
- 8. Set the SELECTOR in the monitor section to "MON."**
- 9. Press the RECORD button once.** (The RECORD LED will blink.)
*The readied track (Track 1) enters input monitoring status.
That is, the electric guitar signal sent to Track 1 is "throughput" to Track 1 output.*
- 10. Raise the INPUT fader to 7-8, and check the recording level on the level meter 1 while playing the electric guitar.**
*Adjust the INPUT fader so that the meter approaches level "0" at a peak volume (and "OL" will not be lit). If the level is too low, set the LEVEL switch to "M (-30dBV)."
If you have connected a microphone or other low output sound source, instead of a line-output source such as an electric guitar, you may want to set the LEVEL switch to the "L (-50dBV)" position.*

Monitoring the recording signal

- 11. Turn Channel 1 MON knob toward "TRK" and raise the MASTER knob setting in the monitor section. Use the MON PAN knob to adjust the stereo image.**
- 12. Adjust the equalizer, if necessary.**
If adjusting the equalizer has changed the level and the "OL" indication on the meter lights up, lower the INPUT fader.

<Hints>

Use the SELECTOR in the monitor section to select monitoring signal.
To monitor the input sound for recording, set the SELECTOR to "MON." Then, turn the corresponding channel MON knob toward "TRK" to send the signal through the recorder section to the monitor section. At this time, turning the MON knob toward "INPUT," you can monitor the pre-fader signal coming from the INPUT jack.

Selecting the "L/R" setting allows you to monitor the recorder input signal (pre-recording signal).

Selecting "L/R+MON" allows you to monitor the both signals, which is convenient for mixdown. Refer to the next page for details on the flow of monitoring signal.

Start recording

- 13. Press the RECORD button while pressing and holding down the PLAY button.**
The blinking RECORD LED and track indication "1" will light up, indicating that the recorder section has entered recording mode. (The recording track, Track 1 in this example, is always in input monitoring status.)

Finish recording

You can record for about 12 minutes (when installing the 540MB hard disk unit) or 30 minutes (when installing the 1.3GB hard disk unit).

- 14. To end recording, press the STOP button.**
At the same time, the input monitoring status will be cancelled, and the recorder will enter playback monitoring status. (The RECORD LED will go off.)

<Note>

Press the STOP button immediately to finish recording when your performance is complete.
If recording mode continues after your performance is finished (as occurs sometimes on tape MTRs), the editing functions (such as Paste and Erase) may be restricted. Refer to page 31 (countermeasures for overtime indication) and page 94 (notes on the paste operation) for details.

In addition to recording sound from INPUT jack 1 to Track 1, you can also record data from any INPUT jack to any track. The table below shows some quick setting hints.

Try recording to see how and where the input signal is routed and recorded. (You can use the same settings regardless of which INPUT jack (of Channels 1-8) is connected to the source.)

Playback

Using the procedure below, you can play back the data you just recorded.

1. Press the **REWIND** button while holding down the **STOP** button.
The DMT-8vl will locate the beginning of the hard disk immediately using the LOCATE ABS 0 operation.
2. To prevent accidental recording, turn the **RECORD TRACK** select key 1/L "OFF." (The track indicator will be turned off.)
3. The **INPUT SEL** switch should stay at "INPUT."
4. The **SELECTOR** in the monitor section should also stay at "MON."
5. Press the **PLAY** button to start play back.
Currently Track 1 is in playback monitoring status. Track 1 output (at Channel 1 INPUT fader) is the actual recorded sound, not the signal being input.
6. Turn Channel 1 **MON** knob toward "TRK," and turn the **MASTER** knob in the monitor section gradually.
You can now monitor the recorded Track 1 playback sound.
7. Use the **MON PAN** knob to adjust the monitoring stereo image.

<Note>

When you are monitoring the sound for a long period of time through the headphones, do not raise the **MASTER** knob setting in the monitor section too high. Otherwise, you could damage your hearing.

<Quick setting table>

Recording Track	Recorder Setting	Master Setting (channels 1 - 8)		Monitor Section
	REC TRACK select key	INPUT SEL switch	PAN control	SELECTOR
Track 1	1/L <input type="checkbox"/> Set "1/L" to READY	Set the switch to "INPUT".	When the INPUT SEL switches are set to "INPUT," the signal input at the INPUT jack is routed to the corresponding INPUT fader. This allows you to record sound while equalizing it, if necessary.	Turn all the way to "L."
Track 2	2/R <input type="checkbox"/> Set "2/R" to READY			Turn all the way to "R."
Track 3	3/L <input type="checkbox"/> Set "3/L" to READY			Turn all the way to "L."
Track 4	4/R <input type="checkbox"/> Set "4/R" to READY			Turn all the way to "R."
Track 5	5/L <input type="checkbox"/> Set "5/L" to READY			Turn all the way to "L."
Track 6	6/R <input type="checkbox"/> Set "6/R" to READY			Turn all the way to "R."
Track 7	7/L <input type="checkbox"/> Set "7/L" to READY			Turn all the way to "L."
Track 8	8/R <input type="checkbox"/> Set "8/R" to READY			Turn all the way to "R."
		When the INPUT SEL switches are set to "TRK," the recorder output signal (track playback signal) is routed to the INPUT fader. This is useful for mixdown, and allows you to adjust the level, balance, and tonal quality of the track playback sound and/or apply effects to the playback sound before you mix down to the master recorder.		Set to "MON."

Signal flow during basic recording

The diagram shown below shows the flow of recording signal and monitoring signal. Remember the route of the input signal sent and recorded to the hard disk and the monitoring signal sent to the monitor section. Also, find out which knob or switch is used to select one of the signals sent simultaneously.

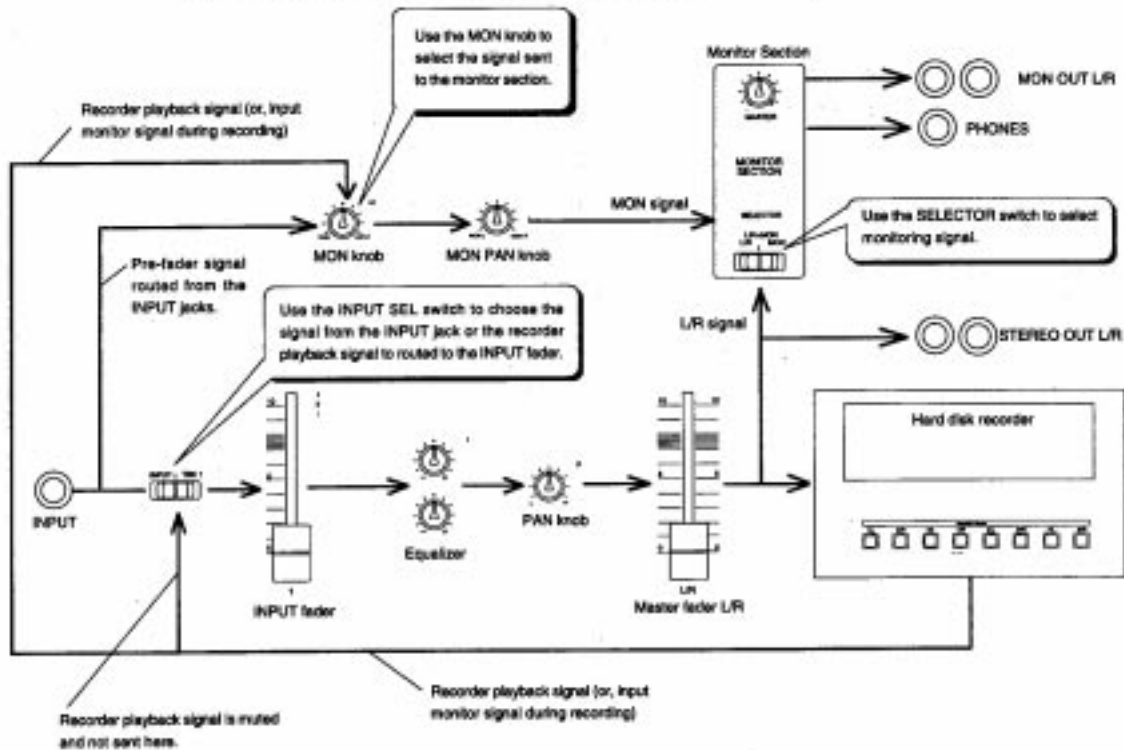

<Notes on recording>

As explained in the section "Before Operating the DMT-8vL," using the mixer function allows you to route the channel signal to the stereo bus L and/or R using the PAN knob, then route it to the corresponding track(s) (Tracks 1/3/5/7 from the stereo bus L, and Tracks 2/4/6/8 from the stereo bus R) for recording. Therefore, you cannot record each different sound source input from INPUT jacks 1-8 into Tracks 1-8 respectively and simultaneously, but sound sources will overlap each other in Tracks 1-8 according to the PAN knob settings.

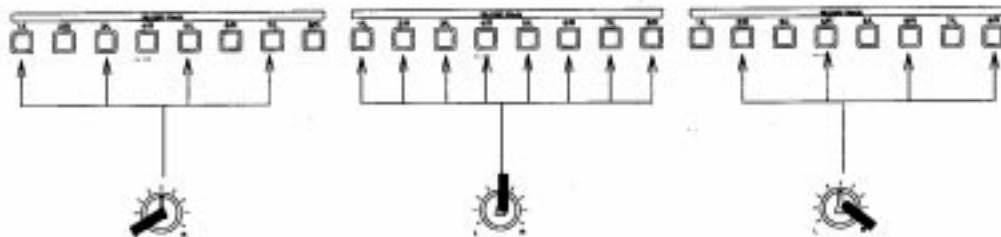

When Tracks 1-8 are selected for recording (that is, all the RECORD TRACK select keys are ON), the channel signals will be routed to multiple tracks according to the PAN knob settings, resulting in overlapping sound in a track.

3. Recording while using the Program Change function (Switching Programs 1-5)

As previously explained, the DMT-8vl has a "Program Change function" to manage up to five songs. You can record, playback, and edit each Program separately. The following section explains basic recording and playback using the Program Change function.

* First, set the DMT-8vl to the default settings.

Changing Programs

1. Press the STORE key while pressing and holding down the HOLD/> key, repeatedly will select from Program 1 to Program 5 as shown in the diagram below.

The following example uses ABS TIME for the Time Base. You can also use the Program Change function when BAR/BEAT/CLK or MTC is selected as the Time Base. Each Program automatically selects the Time Base that was used before you turned the power off previously. You can change the Time Base by pressing the DISP SEL key to switch to the REMAIN indication. (This indication shows the remaining recordable time for all Program 1-5, but not for each Program.)

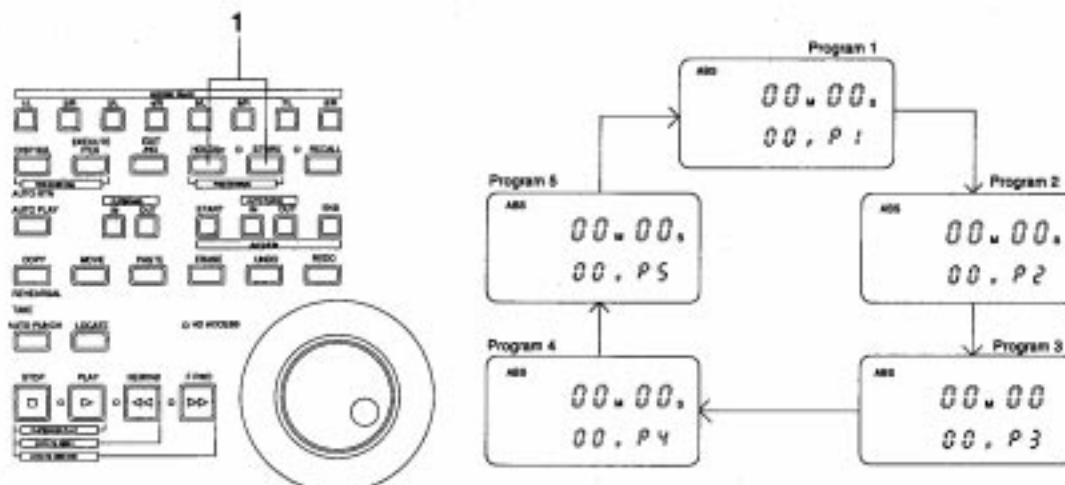

<Note>

The following parameters are available for each Program:

- Time signature (BAR BEAT) ■ TEMPO ■ MTC OFFSET
- PREROLL TIME ■ SLAVE ON/OFF ■ ENABLE/DISABLE REC
- MTC FRAME RATE ■ MIDI SYNC OUT ■ TIME BASE
- CLOCK ON/OFF

The following parameters are commonly applied to all Programs:

- DEVICE ID ■ RESOLUTION ON/OFF ■ UNDO ALL/EDIT
- DIGITAL IN (*) ■ DIGITAL OUT (*) ■ Locate memory (*)

(*) These parameters return to the default settings when the power is turned off.

Recording procedure

2. Select a Program and follow the recording steps described in "Basic recording and playback."

Playback

3. Select a Program to play back.
4. Follow the playback steps described in "Basic recording and playback."

<Note>

Total available recording time for Programs 1-5 depends on the capacity of the equipped hard disk and will be about twelve minutes in a 540MB hard disk and about thirty minutes in a 1.3GB hard disk. Although a maximum twelve minutes (or thirty minutes) can be recorded in one continuous Program, if various different tunes are recorded in multiple Programs, the remaining time can be calculated by deducting the total time from twelve minutes.

In other words, for example, when a 540MB hard disk unit is installed, if you have recorded five-minutes of data to Program 1 and three-minutes of data to Program 2, you can use about four minutes for recording Programs 3-5. Check the REMAIN display for available recording time before recording multiple Programs. (Refer to the diagram below.)

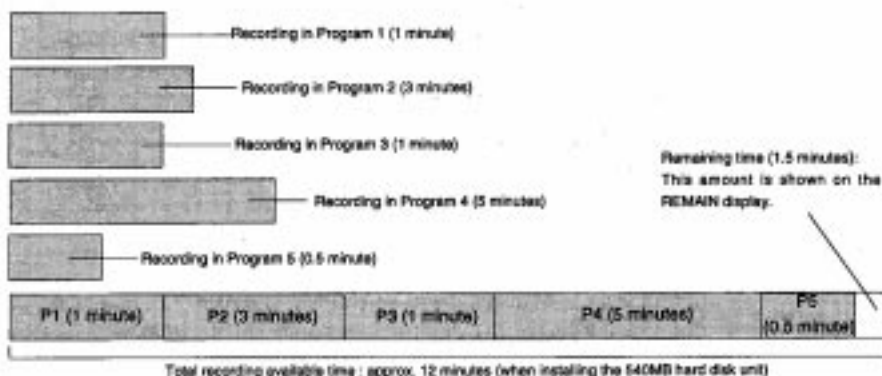

4. Multitrack recording using overdubbing

Now that you understand how to record and play back on the DMT-8vL, we will create a multitrack recording.

Multitrack recording is a series of operations in which you record sound sources to multiple tracks and combine these recordings into two mixes (L, R). In this process, the most important step is "overdubbing." "Overdubbing" means to record a new sound source to another track while monitoring the sound, and also while listening to the playback of the pre-recorded sound (that is, playback monitoring).

As an example, you could overdub various sound sources to Tracks 1-8 as shown in the table below, following the steps described here:

- 1: Recording a drum machine to Track 1
- 2: Overdubbing an electric bass to Track 2 while listening to Track 1
- 3: Overdubbing an electric guitar (lead guitar) on Track 3 while listening to Tracks 1 and 2
- 4: Overdubbing another electric guitar (side guitar) on Track 4 while listening to Tracks 1, 2, and 3

Track 1	Track 2	Track 3	Track 4	Track 5	Track 6	Track 7	Track 8
DRUM Machine	Electric Bass	Electric Guitar	Electric Guitar	VOCAL 1	VOCAL 2	PIANO	SYNTH

- * Make sure that you know which Program you are going to record.
- * Stay in the same Program until all overdubbing steps are complete.

Step 1: Recording a drum machine to Track 1

Refer to the "Basic Recording" section to record the drum machine to Track 1.

Hint 1: Stereo recording of a drum machine

If you wish to record a drum machine in stereo, not in monaural, you can just record the L signal to Track 1 and the R signal to Track 2. Follow the settings described below:

<Channel 1 setting>

Drum machine's L output jack -> Connect it to the **INPUT jack 1** of the DMT-8vL.
 INPUT SEL switch -> "INPUT"
 PAN control -> Turn all the way to "L."
 MON PAN knob -> Turn all the way to "L."
 MON knob -> Turn to "TRK 1" and adjust the monitoring level.

<Channel 2 setting>

Drum machine's R output jack -> Connect it to the **INPUT jack 2** of the DMT-8vL.
 INPUT SEL switch -> "INPUT"
 PAN control -> Turn all the way to "R."
 MON PAN knob -> Turn all the way to "R."
 MON knob -> Turn to "TRK 2" and adjust the monitoring level.

<Recorder setting>

RECORD TRACK select key -> Press "1/L" and "2/R" to set Tracks 1 and 2 into ready mode.

<Master setting>

Set the Master faders L/R to 7-8.

<Monitor section setting>

SELECTOR -> Set to "MON."
 Master knob -> Adjust the headphones volume level.

Hint 2: Applying reverberation to the snare sound

If you have a drum machine that has parallel connectors, it may be a good idea to apply reverberation to the snare sound before recording the sound to Tracks 1 and 2. It is very effective to use the AUX function of the DMT-8vL to apply ambience effects such as reverberation. (Refer to the section "Step 4: overdubbing the vocal sound to Track 4" or "Mixdown" for more information on the AUX function.)

You can refer to the settings below:

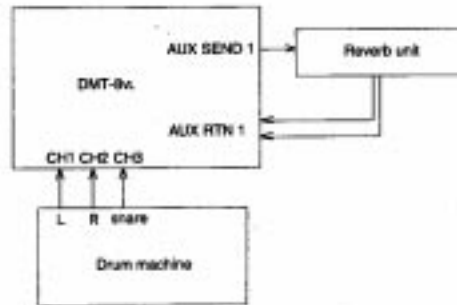
**<Channel 1 setting>**

Same as Hint 1.

<Channel 2 setting>

Same as Hint 1.

<Channel 3 setting>

Drum machine's snare output -> Connect it to the INPUT jack 3 of the DMT-8vL.

INPUT SEL switch -> "INPUT"

PAN control -> Center (The stereo image of the snare sound is centered.)

INPUT fader -> accordingly

<Channel 3 AUX setting>

AUX control -> Turn the knob toward "A1" to adjust the amount of the signal sent to the reverb unit.

<Master settings>

AUX RTN 1 control -> Adjust the reverberation amount.

Master faders L/R -> 7-8

Step 2: Overdubbing an electric bass to Track 2

* Restore the initial setting of the DMT-8vL. Especially, do not forget to set Track 1 to "SAFE" mode (the track indicator is off.).

Now, we are going to overdub. Assume that you have recorded the drum machine to Track 1 in monaural, and we are recording the bass to Track 2 while monitoring the drum sound.

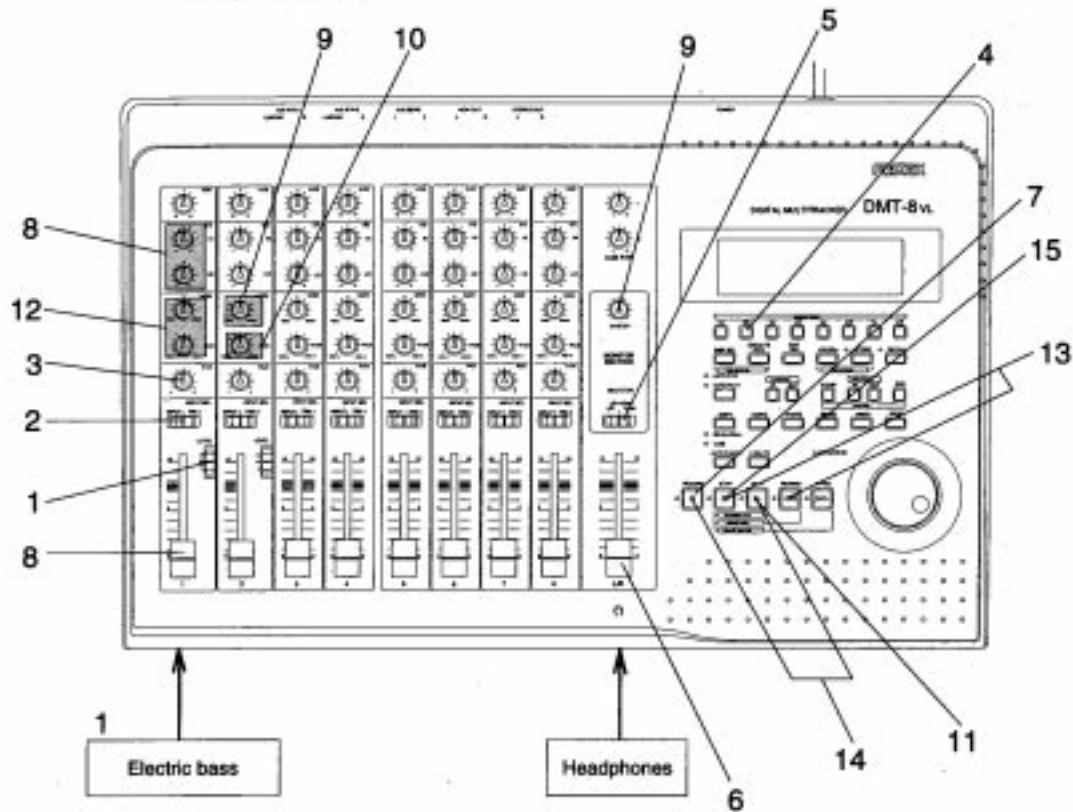

Connecting the sound source

1. Connect the electric bass to any available INPUT jack. (In this tutorial, we connect it to INPUT jack 1.)

If you connect the bass to Channel 1 or 2, set the LEVEL switch to the "H (-10dBV)" position, as we did in the basic recording.

Switch / control settings

2. Set the INPUT SEL switch of Channel 1 which is connected to the electric bass to "INPUT."

3. Turn the PAN control of the electric bass Channel 1 all the way to "R."

4. Press the RECORD TRACK select key "2/R" to "ready" Track 2.

5. Set the SELECTOR in the monitor section to "MON."

Adjusting the recording level

6. Raise the Master faders L/R to "7-8."

7. Press the RECORD button once. (The RECORD LED will blink.)

The readied Track "2" enters input monitoring status.

Step 3: Overdubbing an electric guitar on Track 3

* Restore the initial setting of the DMT-8VL. In particular, do not forget to set Tracks 1 and 2 to "SAFE" mode (the track indicators should be off).

Just as in Step 2, overdub the electric guitar on Track 3 while listening to the recorded drum machine and electric bass.

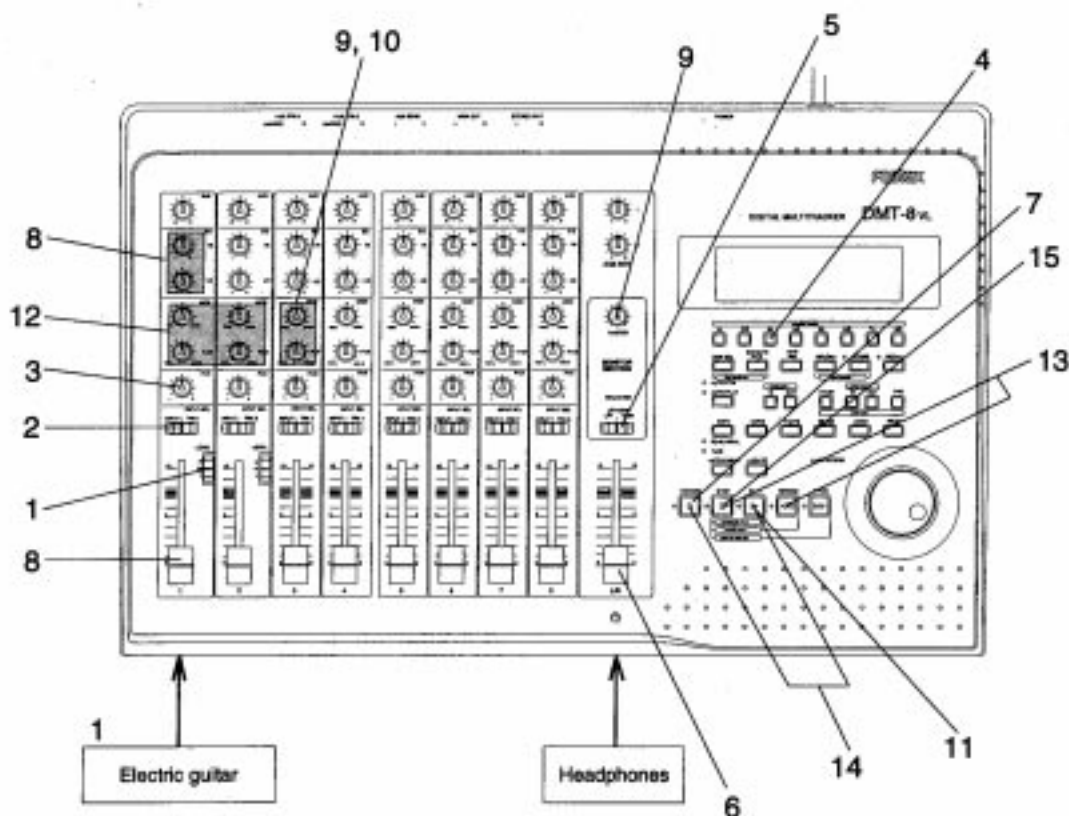

Connecting the sound source

1. Connect the electric guitar to any available INPUT jack. (In this tutorial, we connect it to INPUT jack 1.)

If you connect the guitar to Channel 1 or 2, set the LEVEL switch to the "H (-10dBV)" position, as we did in the basic recording.

Switch / control settings

2. Set the INPUT SEL switch of Channel 1 which is connected to the electric guitar to "INPUT."

3. Turn the PAN control of the electric guitar Channel 1 all the way to "L."

4. Press the RECORD TRACK select key "3/L" to "ready" Track 3.

5. Set the SELECTOR in the monitor section to "MON."

Adjusting the recording level

6. Raise the Master faders L/R to "7-8."

7. Press the RECORD button once. (The RECORD LED will blink.)

The readied Track "3" enters input monitoring status.

8. Raise the INPUT fader of the electric bass Channel 1 to "7-8," check the level on the meter "2", and use the INPUT fader and equalizer to create a desirable tonal color and level. If the level is too low, set the LEVEL switch to "M (-30dBV)."

Monitoring the recording signal

9. To monitor the bass sound, turn the Channel 2 MON knob to "TRK 2" and turn the MASTER knob in the monitor section little by little.
10. Adjust the monitoring stereo image using the MON PAN knob.

Practicing overdubbing

Now, we are going to play back the drum sound on Track 1 and monitor the sound in conjunction with the electric bass sound.

11. Press the PLAY button to start the recorder. (The RECORD LED will continue to blink.)

12. Turn the Channel 1 MON knob to "TRK 1" to adjust the level of the Track 1 playback (drum machine - playback monitor sound), and use the MON PAN knob to adjust the monitoring stereo image.

Play the electric bass while listening to the drum machine sound on Track 1.

You can listen to both the drum machine sound (playback monitor) and the electric bass sound (input monitor) at the same time. Use the MON knob and MON PAN knob of Channel 1 and Channel 2 to balance both sounds.

Since the bass sound has not yet been recorded, you can practice your performance with these settings as many times as you like.

Start / stop recording

If you are satisfied with your rehearsal, start recording.

13. Press the REWIND button while holding down the STOP button to locate the ABS 0 point (start point of the recorder).

14. Press the RECORD button while holding down the PLAY button.

The drum machine sound on Track 1 will be played back with the monitor balance setting specified in the previous step. Play the electric bass to overdub the bass sound on Track 2.

15. When the recording is completed, press the STOP button to stop recording.

The RECORD LED goes off, and Tracks 1 and 2 enter playback monitoring status.

Playback

1. Press the REWIND button while holding down the STOP button.
2. To prevent accidental recording, set the RECORD TRACK switch "2/R" to "OFF."
3. Set the INPUT SEL switches for Channels 1 and 2 to "OFF."
4. Press the PLAY button to start playback.
5. Turn the MON knobs for Channels 1 and 2 to "TRK 2" and turn the MASTER knob in the monitor section little by little.
6. Adjust the stereo image of the playback monitor using the MON PAN knobs for Channels 1 and 2.

8. Raise the INPUT fader of the electric guitar Channel 1 to "7-8," check the level on the meter "3", and use the INPUT fader and equalizer to create a desirable tonal color and level. If the level is too low, set the LEVEL switch to "M (-30dBV)."

Monitoring the recording signal

9. To monitor the guitar sound, turn the Channel 3 MON knob to "TRK 3" and slowly turn the MASTER knob in the monitor section.
10. Adjust the monitoring stereo image using the MON PAN knob.

Practicing overdubbing

Now, we are going to play back the drum sound on Track 1 and the electric bass sound on Track 2, and monitor the sound in conjunction with the electric guitar sound.

11. Press the PLAY button to start the recorder. (The RECORD LED will continue to blink.)
12. Turn the Channel 1 MON knob to "TRK 1" to adjust the level of the Track 1 playback (drum machine - playback monitor sound), turn the Channel 2 MON knob to "TRK 2" to adjust the level of Track 2 playback (electric bass - playback monitor sound), and use the MON PAN knob to adjust the monitoring stereo image.
Play the electric guitar while listening to the drum machine sound on Track 1 and the electric bass sound on Track 2.
You can listen to both the drum machine and electric bass sound (playback monitor), and the electric guitar sound (input monitor) at the same time. Use the MON knob and MON PAN knob of Channels 1-3 to balance the sounds.
Since the guitar sound has not been recorded yet, you can practice your performance with these settings as many times as you like.

Start / stop recording

If you are satisfied with your rehearsal, start recording.

13. Press the REWIND button while holding down the STOP button to locate the ABS 0 point (start point of the recorder).
14. Press the RECORD button while holding down the PLAY button.
The drum machine sound on Track 1 and the electric bass sound on Track 2 will be played back with the monitor balance setting specified in the previous step. Play the electric guitar to overdub the guitar sound on Track 3.
15. When the recording is completed, press the STOP button to stop recording.
The RECORD LED goes off, and Tracks 1-3 enter playback monitoring status.

Playback

1. Press the REWIND button while holding down the STOP button.
2. To prevent accidental recording, set the RECORD TRACK switch "3/L" to "OFF."
3. Set the INPUT SEL switches for Channels 1-3 to "OFF."
4. Press the PLAY button to start playback.
5. Turn the MON knobs for Channels 1-3 to "TRK" and turn the MASTER knob in the monitor section little by little.
6. Adjust the stereo image of the playback monitor using the MON PAN knobs for Channels 1-3.

Step 4: Overdubbing the vocal on Track 4

* Restore the initial setting of the DMT-8vl. In particular, do not forget to set Tracks 1-3 to "SAFE" mode (the track indicators should be off).

Now, overdub the vocal on Track 4 while listening to the recorded drum sound, the electric bass, and the electric guitar.

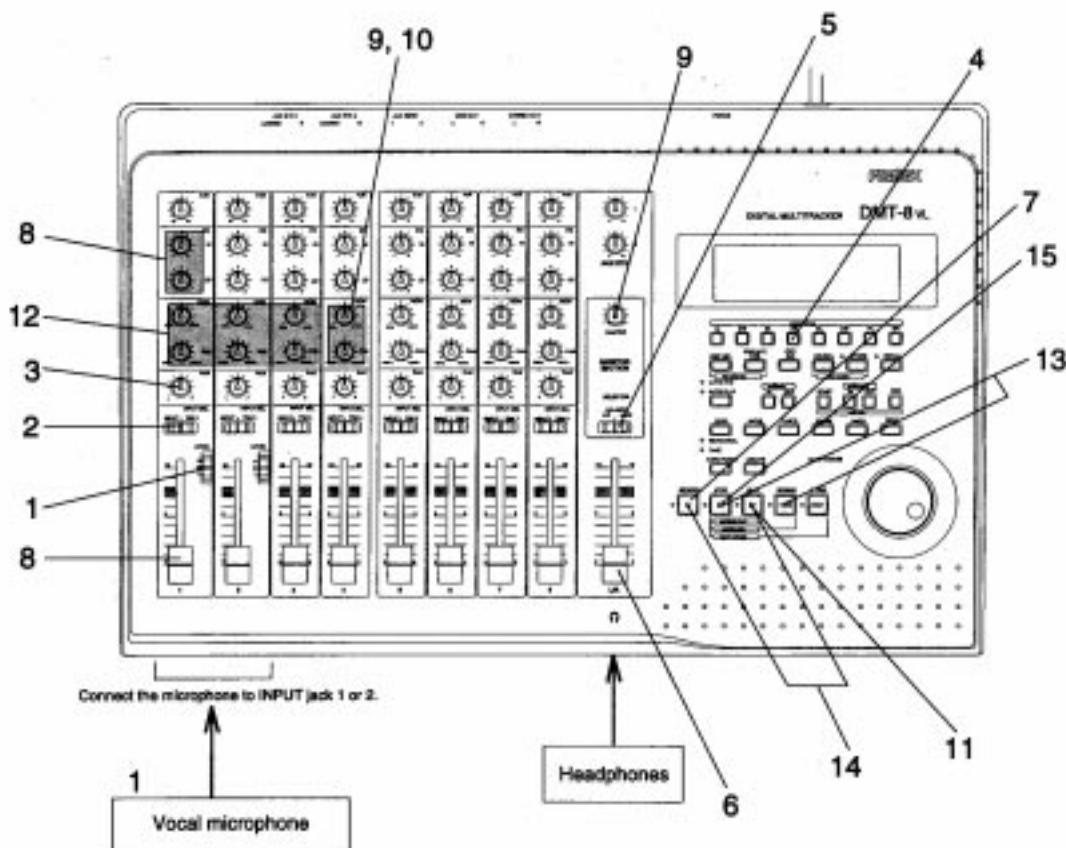

Connecting the sound source

1. Connect the vocal microphone to any available INPUT jack. (In this tutorial, we connect it to INPUT jack 1.)
If you connect the guitar to Channel 1 or 2, set the LEVEL switch to the "H (-10dBV)" position, as we did in the basic recording.

Switch / control settings

2. Set the INPUT SEL switch of Channel 1 which is connected to the microphone to "INPUT."
3. Turn the PAN control of the microphone Channel 1 all the way to "R."
4. Press the RECORD TRACK select key "4/R" to "ready" Track 4.
5. Set the SELECTOR in the monitor section to "MON."

Adjusting the recording level

6. Raise the Master faders L/R to "7-8."
7. Press the RECORD button once. (The RECORD LED will blink.)
The readied Track "4" enters input monitoring status.

8. Raise the INPUT fader of the microphone Channel 1 to "7-8," check the level on the meter "4", and use the INPUT fader and equalizer to create a desirable tonal color and level. If the level is too low, set the LEVEL switch to "M (-30dBV)."

Monitoring the recording signal

9. To monitor the vocal sound, turn the Channel 4 MON knob to "TRK 4" and slowly turn the MASTER knob in the monitor section.
10. Adjust the monitoring stereo image using the MON PAN knob.

Practicing overdubbing

Now, we are going to play back the drum sound on Track 1, the electric bass sound on Track 2, and the electric guitar sound on Track 3, which we monitor the sound in conjunction with the vocal sound.

11. Press the PLAY button to start the recorder. (The RECORD LED will remain blinking.)
12. Turn the Channel 1-3 MON knobs to "TRK" to adjust the level of Track 1 (drum machine), Track 2 (electric bass), and Track 3 (electric guitar) (all playback monitor sound), and use the MON PAN knob to adjust the monitoring stereo image.

Sing while listening to the sound on Tracks 1-3 (drum machine, electric bass, and electric guitar). You can listen to both the vocal sound and already recorded sound at the same time. Use the MON knob and MON PAN knob of Channels 1-4 to balance the sounds.

Since the vocal sound has not yet been recorded, you can practice your performance with these settings as many times as you like.

Start / stop recording

If you are satisfied with your rehearsal, start recording.

13. Press the REWIND button while holding down the STOP button to locate the ABS 0 point (start point of the recorder).
14. Press the RECORD button while holding down the PLAY button.
The sound on Tracks 1-3 will be played back with the monitor balance setting specified in the previous step. Sing to overdub the vocal sound on Track 4.
15. When the recording is completed, press the STOP button to stop recording.
The RECORD LED goes off, and Tracks 1-4 enter playback monitoring status.

Playback

1. Press the REWIND button while holding down the STOP button.
2. To prevent accidental recording, set the RECORD TRACK switch "4/R" to "OFF."
3. Set the INPUT SEL switches for Channels 1-4 to "OFF."
4. Press the PLAY button to start playback.
5. Turn the MON knobs for Channels 1-4 to "TRK" and slowly turn the MASTER knob in the monitor section.
6. Adjust the stereo image of the playback monitor using the MON PAN knobs for Channels 1-4.

In this way, you can overdub different sound sources to different tracks. Now that you understand how to overdub, you can repeat this procedure for Tracks 5, 6, 7, and 8.

5. Mixdown

Mixdown is the final step in multitrack recording and allows you to combine multiple track recordings to L and R channels (two mixes), and copy the data to a master recorder.

For example, we will mix down eight tracks (refer to the following table) after applying effects using the AUX function, equalizing, and adjusting the panpot balance and volume level.

The DMT-8vi is equipped with a DATA OUT connector that outputs a digital signal (in S/P DIF format), as well as STEREO OUT L/R jacks that output analog signal for mixdown (which corresponds to the stereo bus L/R output). Therefore, you can connect a DAT machine equipped with an optical input for high-quality digital mixdown without sound deterioration.

* Set the DMT-8vi to the default settings.

* Assume that the following sound sources have already been recorded to eight tracks.

1	2	3	4	5	6	7	8
E. bass	L	R	Vocal	Rhythm Guitar	Lead Guitar	Piano	Synth
	Drums						

* Here, we are using two effect units; reverb unit (connected to AUX 1), and chorus (connected to AUX 2).

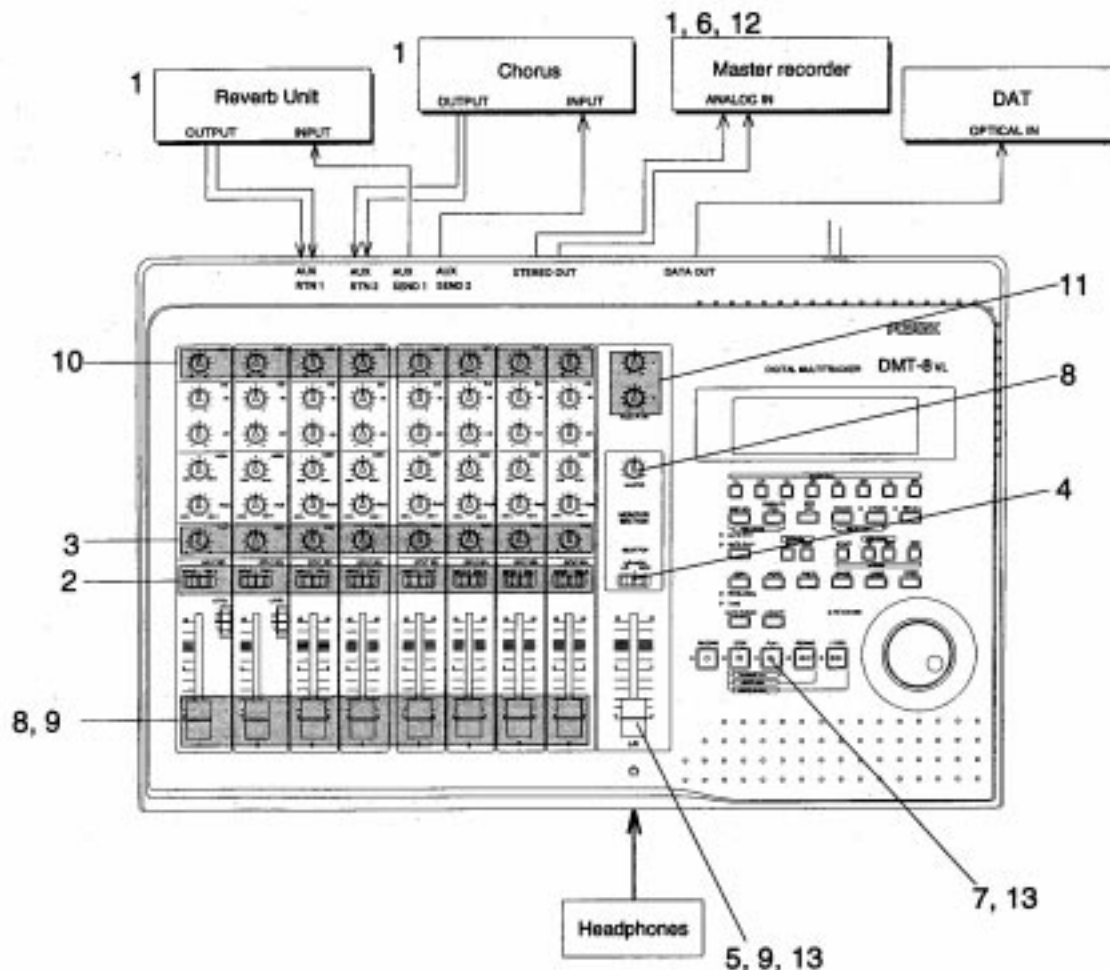

Connecting the effect units and the master recorder

1. Refer to the diagram above to connect two effect units (reverb unit/chorus) and a master recorder (DAT or analog master recorder).

Channel switch and knob settings

2. Set the INPUT SEL switches for all Channels 1-8 to "TRK."
During the overdubbing operation, these switches were set to "INPUT." Make sure that all these switches are set to "TRK" during mixdown. With these settings, all Track 1-8 outputs will be routed to INPUT faders 1-8, and you can apply equalization and/or effects to the output signals.
3. Set the PAN knobs for Channels 1-8 as follows to adjust the stereo image of the recorded sounds.

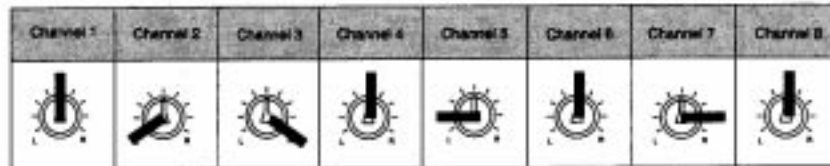

4. Set the SELECTOR in the monitor section to "L/R."
5. Raise the Master faders L/R to "7-8."

Adjusting the output level of the DMT-8vL and the recording level of the master recorder

6. Set the master recorder into recording stand-by mode (in which you can check the recording level).
7. Press the PLAY button to play back data on the recorder section.
8. Raise the channel INPUT faders, and slowly turn the MASTER knob in the monitor section to adjust the playback level of each track while monitoring the sound through the headphones.
9. While observing the meter L/R on the DMT-8vL, adjust the INPUT faders so that the "OL" indication will not light up with the peak signal.
After adjusting the balance using the INPUT faders, adjust the entire output level using the Master faders L/R and the input level on the master recorder.

Setting AUX and applying effects

10. Turn the AUX 1 control of the track channel to which you wish to apply an effect toward "A1" (the signal is sent to the reverb unit) or "A2" (the signal is sent to the chorus unit) and adjust the AUX SEND 1/2 level.
11. You can use the AUX RTN 1 and 2 controls to adjust the reverb/chorus return level and route the processed signal to the stereo bus L/R.

Actual mixdown

12. When you are satisfied with the tonal color, level, and effect balance, and the meter L/R shows an appropriate level, set the master recorder to recording mode.
You also need to adjust the input level on the master recorder if you are mixing down analog data from the STEREO OUT L/R jacks to the master recorder so that the level meter on the master recorder will show the same level as the meter L/R on the DMT-8vL.
13. Press the PLAY button to start playback from the beginning.
Use the Master faders L/R to add a fade-in/out effect.

* Refer to the section "Digital Recording from the DMT-8vL to an External Digital Device" for more information on mixing down digital data to a DAT machine.

6. Digital Recording from an External Digital Device to the DMT-8vL

This section explains how to digitally record data from a connected external digital device (CD player, MD player, DAT, etc.) to a track or tracks on the DMT-8vL. You need to use the "dG in" setting in SETUP mode to assign two tracks to record input digital L/R signals.

Connecting an external digital device

1. Connect the DATA IN jack of the DMT-8vL to the OPTICAL OUT of the external digital device (CD, MD, or DAT).

* If the external digital device has only a COAXIAL type connector for digital output, use an optional COP-1 optical/coaxial converter.

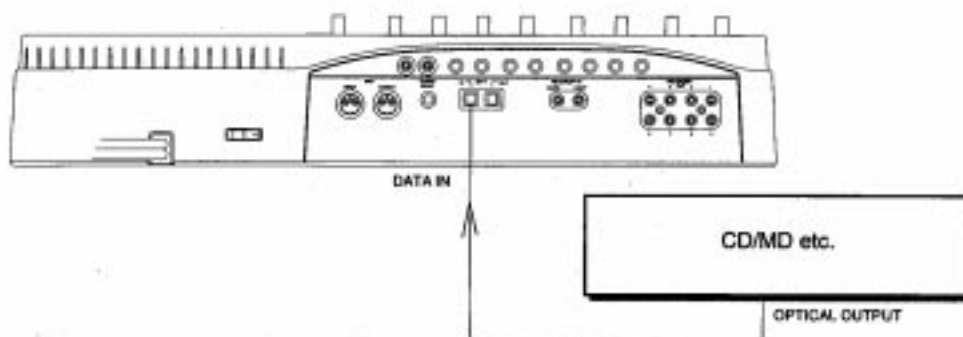

Selecting a recording Program (1-5)

1. Press the STORE key while pressing and holding down the HOLD/> key, repeatedly will select a recording Program.

Press the DISP SEL key to show the REMAIN display and check the available recording time. If there is not enough time left for recording, use the Cut function to move the ABS END point of the other Programs backward, or back up the data to a DAT machine to obtain sufficient free disk space.

* Refer to page *104* for the Cut function, and to page *117* for the Save operation.

Selecting a recording track

1. Using "dG in" in Setup mode, select a recording track.

You can select any track from Tracks 1-8.

If the digital signal is being input correctly, the display will show the illuminated message "DIGITAL". If the signal input is incorrect, this message will blink.

<CAUTION>

Do not connect or disconnect the optical cable to or from the DATA IN connector while the digital input is routed to any track. Otherwise, the DMT-8vL may generate noise, affecting the external devices.

When the SETUP mode setting is completed, press the EXIT/NO key to exit SETUP mode.

Refer to page *129* for details on "dG in" of Setup mode.

2. Press the RECORD TRACK select key for the track you assigned in Step 1 to set the track to "READY".

Starting / finishing recording

1. Press the **REWIND** button while pressing and holding down the **STOP** button to locate the beginning of the recordable area on the disk.
2. Confirm that **"DIGITAL"** on the display is lit, and press the **RECORD** button while holding down the **PLAY** button on the DMT-8vL to start recording. (If **"DIGITAL"** is not lit, start playing back data on the external digital device first, and check to see if digital signal is output correctly from the **OPTICAL OUT** connector of the digital device.) You do not need to adjust the digital recording level.
3. Start playing back data on the external digital device.
4. When recording is complete, press the **STOP** button.

<Note>

You cannot record analog signals to those tracks to which the digital inputs are routed. When you finish recording digital data, be sure to set the assignment to **" - "** (no assignment).

You can route analog signals from the mixer inputs (or **RECORDER IN** connector) to any track that is not assigned as digital input L or R.

<Note>

The digital output will be muted if any one of the tracks is set to **DIGITAL IN**. At this time, the L/R level meters will not respond.

7. Digital Recording from the DMT-8vL to an External Digital Device

This section explains how to record songs that already exist on the DMT-8vL to an external DAT or MD recorder. Only one of the following combinations of the tracks can output data digitally: 1-2, 3-4, 5-6, 7-8, S-t (STEREO OUT L/R in the mixer section).

Using the **"dG out"** field in Setup mode, assign any track combination described above to the digital output L/R channels. (You can still get analog output of a track that is assigned to the digital output channel.)

* Set the DMT-8vL to the default setting.

Connecting an external digital device

1. Connect an optical cable to the DMT-8vL's **DATA OUT** and to the **OPTICAL IN** connector on the external digital device.

* If the external digital device has only coaxial connectors for digital input, use an optional COP-1 optical/coaxial converter.

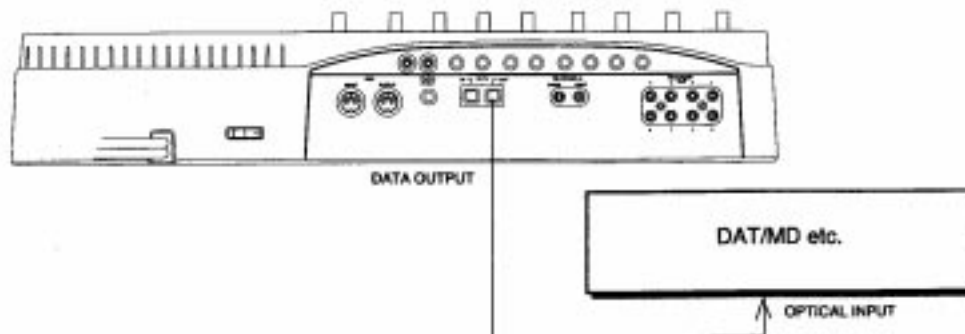

Selecting the Program number and track for output

1. Press STORE key while pressing and holding down the HOLD/> key, repeatedly to select the Program.
2. Assign the output track in "dG out" under Setup mode on the DMT-8vL.
If you select tracks 1-2, 3-4, 5-6, or 7-8, the odd-numbered track will be assigned to the digital output L channel, and the even-numbered track will be assigned to the digital output R channel.
If you select "S-t," the STEREO OUT L/R output of the DMT-8vL will be assigned. This allows for digital mixdown to a DAT machine as mentioned previously in the section "Mixdown."

When the SETUP mode setting is completed, press the EXIT/NO key to exit SETUP mode.

* Refer to page *131* for details on "dG out" under Setup mode.

Starting / finishing recording

1. Press the REWIND button while pressing and holding down the STOP button to locate the beginning of the data (ABS 0) on the disk.
2. Start recording on the external digital device.
3. Press the PLAY button on the DMT-8vL to start playing back data.
4. When recording is complete, press the STOP buttons on both the DMT-8vL and the digital device.

<Note>

The digital output will be muted in the following situations. At this time, the L/R level meters will not respond.

1. When the DMT-8vL is in LOAD mode, or
2. When any one of the tracks is set to DIGITAL IN.

Recording and Playback (Application Guide)

This section explains how to perform ping-pong recording. It also describes the MIDI Clock synchronization system, the MTC sync/machine control system, and recording in DMT-8vL's slave mode, using the DMT-8vL MIDI functions. It also covers how to use only the recorder section of the DMT-8vL.

1. Ping-pong recording

Ping-pong recording enables you to combine multiple recorded tracks and copy them to an empty track. You can then overdub additional sounds onto the previously-recorded tracks, adding instruments or other musical parts to your recording.

- * In this example, we are going to ping-pong Tracks 1 through 6 to Tracks 7 and 8.
- Since effects cannot be applied to each sound individually after ping-pong recording, we need to apply effects here on the mixer and record the effect sound to Tracks 7 and 8.
- * Set the DMT-8vL to the default setting.
- * Make sure that you have selected a Program.

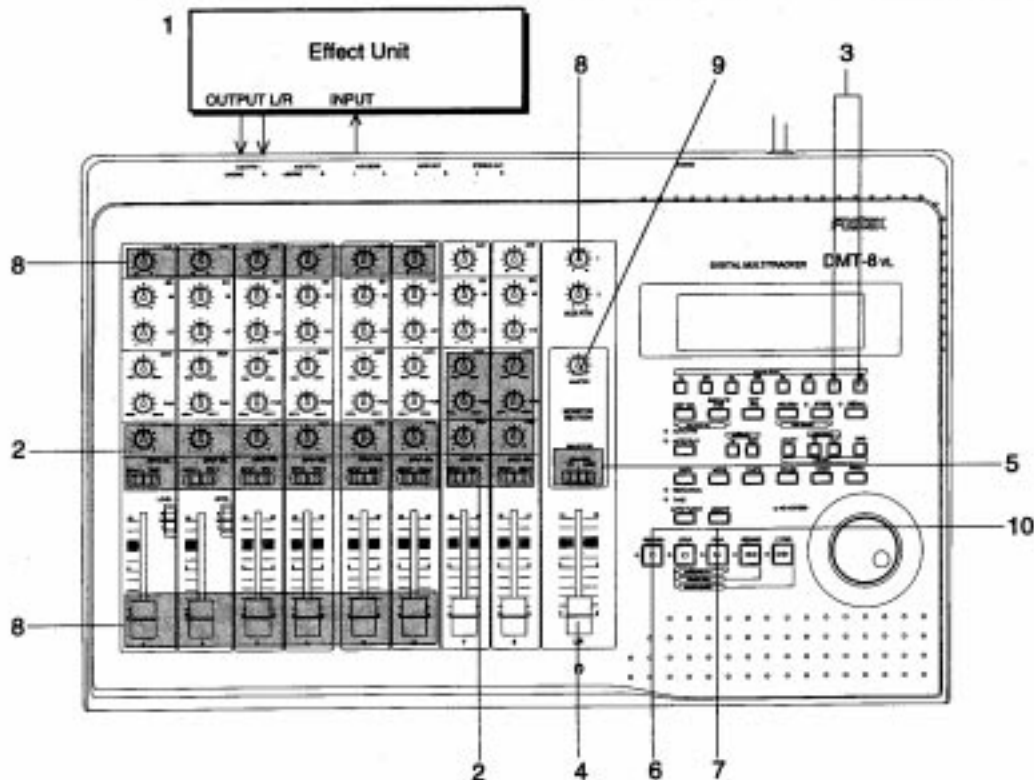
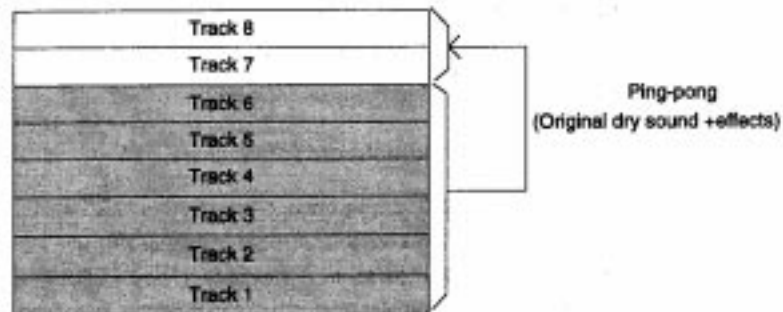

Connecting an effect unit

1. Connect a desired effect unit using the AUX connection as mentioned in the "Basic Guide" section.

Switch / knob settings

2. Set the channel switches and knobs as follows:

Channel	INPUT SEL switch	PAN	MON knob	MON PAN
1 - 6	"TRK" Playback signal from Tracks 1-6 will be routed to the corresponding INPUT fader.	A stereo image of the entire sound is created by the sounds of Track 7 and Track 8 sound (Track 7: L, Track 8: R). Use the PAN knobs for Channels 1-6 to set the routing of each track.	"0"	
7, 8	"OFF"	-	Turn the knob all the way to "TRK."	7: "L" 8: "R"

3. Press the RECORD TRACK select key "7/L" and "8/R" to make Tracks 7 and 8 "READY."
4. Raise the master faders L/R to 7-8.
5. Set the SELECTOR in the monitor section to "MON."

Monitoring / Level adjustment / Rehearsal

6. Press the RECORD button once. (The RECORD LED will blink.)
"Ready" tracks 7 and 8 enter input monitoring status.
7. Press the PLAY button to start playback. (The RECORD LED will continue to blink.)
Tracks 1-6 will enter playback monitoring status, and Tracks 7 and 8 will enter input monitoring status.
8. Use the INPUT faders 1-6 and PAN knobs to adjust the level and balance between tracks, and turn the AUX knobs 1-6 toward "A1" to adjust the effect balance.
At this time, adjust the level carefully so that the "OL" indication of meters 7 and 8 will not light up.
9. Use the MASTER knob in the monitor section to adjust the monitoring volume.
After adjustment and rehearsal is complete, locate the beginning of the recorded data.

Actual ping-pong recording

10. Press the PLAY button while pressing and holding down the RECORD button to start ping-pong recording.

2. MIDI Clock synchronization system

In this section, we will learn how to insert a time signature at any location of the song and set the tempo using the internal Program Tempo Map, in order to synchronize an external stand-alone MIDI sequencer to the MIDI Clock as a slave machine.

You can use all eight tracks on the DMT-8vL (unlike conventional tape multitrack recorders, on which you must sacrifice one track for the FSK signal).

Also, you can route the signal from the INPUT jacks and the signal from the recorder to route alternately to the INPUT faders and the MON knobs using the INPUT SEL switches. (This is called Alternate Mix function.)

For example, you can route the recorder signal to the INPUT faders, route maximum eight MIDI sound sources connected to the INPUT jacks to the MON knobs, and route the MON OUT L/R signal to RECORDER IN.

In this way, you can mix down maximum 16 channel sound sources without an external mixing console (parallel twin mix).

- * Set the DMT-8vL to the default setting.
- * Make sure that you have already selected an appropriate Program number.

Connecting an external device

1. Connect the DMT-8vL MIDI OUT connector to the MIDI IN connector on the MIDI sequencer.
2. Set the MIDI sequencer to "MIDI Clock Slave mode" and connect the MIDI sound source that plays sequence data to the INPUT jack of the DMT-8vL.

This MIDI sound source will not be recorded (it will only be played back, synchronizing to a MIDI sequencer). Set the mixer so that you can monitor the sound.

3. Connect the effect unit, if necessary.

(AUX SEND 1 -> Effect unit 1 -> AUX RTN 1, AUX SEND 2 -> Effect unit 2 -> AUX RTN 2)

MIDI SYNC OUT settings

1. Set "MIDI SYNC OUT" in Setup mode to "MIDI Clock (CLOCK) OUT."

If you wish to use the metronome function, set "CLICK" in Setup mode to ON.

* Refer to pages *125* of the SETUP mode section for details

Creating a Tempo Map

1. Set a time signature for each measure using the "BAR" parameter in Setup mode. Then, set the tempo for each bar/beat location using the "TEMPO" parameter in Setup mode.

* Refer to page *113* of the SETUP mode section for details.

2. Run the DMT-8vL in record mode to confirm that the MIDI sequencer will synchronize to the Tempo Map. (You do not need to record any particular sound because this step just makes an already-recorded disk area.) (If data has already been recorded up to the end point of the song, just play back the DMT-8vL.) Set the Time Base to "BAR/CLK" to check whether the playback position on the MIDI sequencer matches that on the DMT-8vL.

Overdubbing

1. Overdub performance data to Tracks 1-8 while accompanying the synchronizing MIDI source output (as if the source was data already recorded on the track). Alternatively, you can actually record the MIDI sound source in a track as a guide or accompaniment track.

Mixdown while synchronizing the MIDI sound source

When overdubbing to Tracks 1-8 is complete, you can start mixdown. As shown in the figure, connect the MIDI sound source to the DMT-8vL, and using this as a virtual track, synchronize other tracks while applying effects and mixing down.

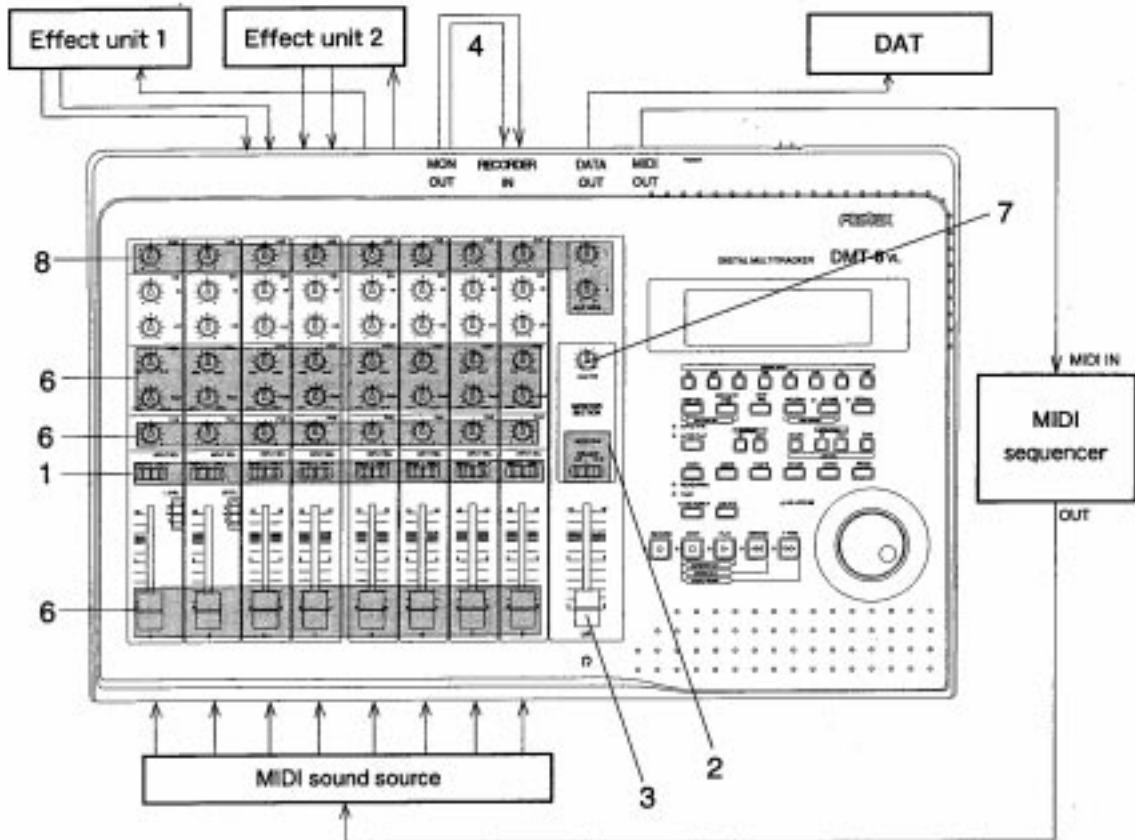

Switch and knob settings/connection

1. Set the INPUT SEL switches for Channels 1-8 to "TRK."
2. Set the SELECTOR in the monitor section to "L/R + MON."
3. Raise the Master faders L/R to 7-8.
4. Connect the MON OUT L/R jack and the RECORDER IN jack.
Returning the MIDI sound source signal from the MON OUT L/R to RECORDER IN allows you to mix down the playback signal on Tracks 1-8 with signal of up to 16 channels of MIDI sound sources connected to the INPUT jacks.
5. Set "dG out" of SETUP mode to "S-1."
Now the Track 1-8 signal output from the STEREO OUT L/R and the MIDI sound source signal that have passed via the MON knobs are mixed and output from the DATA OUT connector.

* Refer to page "131" for details on "dG out" of SETUP mode.

6. Use the channel INPUT fader and PAN knob to adjust the playback level and stereo image of Tracks 1-8. Turn the MON knob of the connected channel to the "INPUT" side to adjust the input level of the MIDI sound source, and use the MON PAN knob to adjust its stereo image.
7. Use the MASTER knob in the monitor section to adjust the final mixdown level.
8. If you wish to apply an effect to a certain track sound, use the AUX knob and AUX RTN knob of the corresponding channel to adjust the effect amount and balance.

3. MTC Synchronization/Machine Control system

This paragraph explains the control system via computer using MMC (MIDI Machine Control), and the synchronization system using MTC (MIDI Time Code) output from the DMT-8vL.

The DMT-8vL can output MTC at any frame rate by adding a time offset (with a time difference of less than six hours) to the ABS (absolute) time of the hard disk. You can also control the DMT-8vL from an external device by sending MMC (MIDI Machine Control) or Fostex System Exclusive Messages. In this case, you will set a DEVICE ID number in the "DEVICE" parameter of Setup mode on the DMT-8vL. Therefore, multiple DMT-8vLs can be controlled individually by changing the DEVICE ID number within the messages sent from the computer.

Refer to "MMC List" on page "137" for more information on MMC, and to "Fostex System Exclusive List" on page "138" for more information on Fostex System Exclusive Messages. When the DMT-8vL receives the MMC Rehearsal messages (WRITE: 40h, RECORD MODE: 4ch), the REHEARSAL LED will blink, indicating that Manual Punch In/Out recording Rehearsal mode is entered.

- Set the DMT-8vL to the default setting.
- Make sure that you have selected an appropriate Program number.

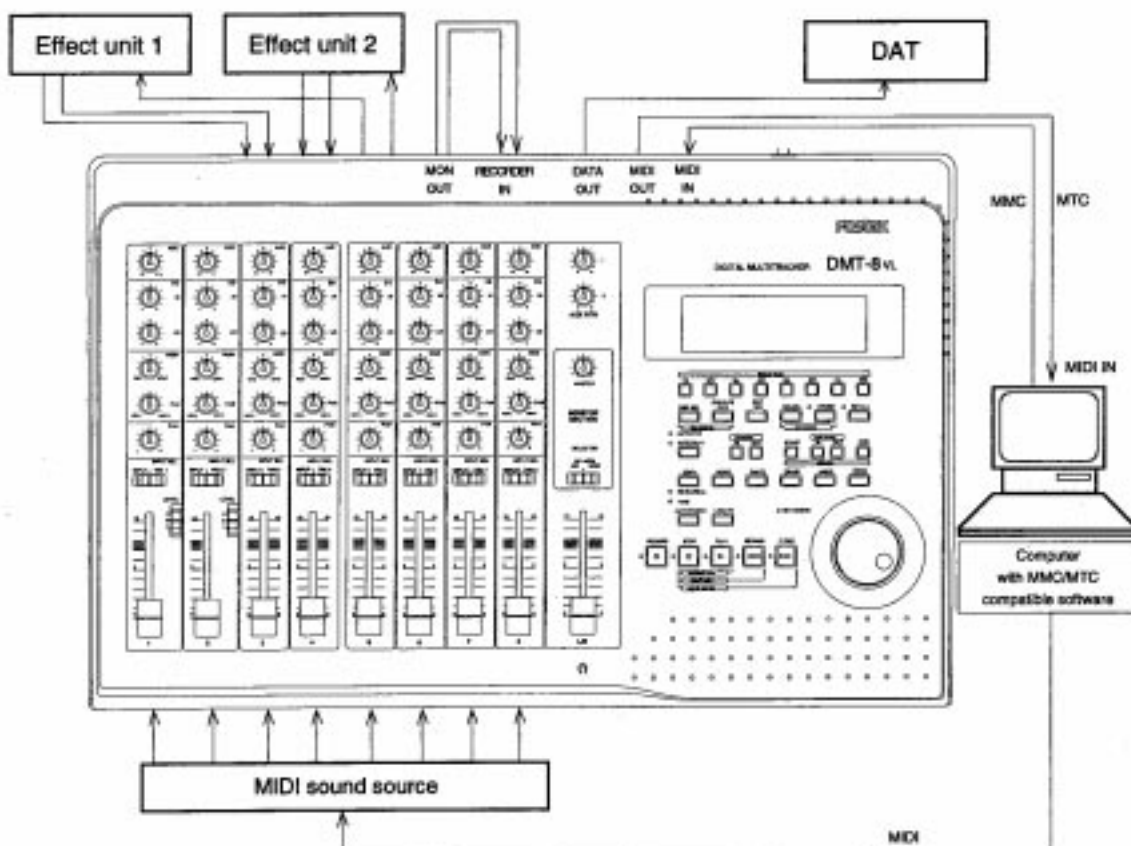

Connecting an external device

1. Connect the MIDI IN/OUT connectors on the DMT-8vL to the MIDI IN/OUT connectors of a computer (using a MIDI interface). (Start a sequencing software application on your computer that is compatible with MMC/MTC.)

2. Set the sequencing software application to MTC slave mode and MMC output mode, and select a desired frame rate.

Refer to the "MIDI Clock Synchronization system" section for information about connecting the MIDI sound source and effect units to the DMT-8vL.

Setting the MIDI SYNC OUT

1. Select "MTC (mtc)" for "MIDI SYNC OUT" in Setup mode. At this time, it is useful to set Time Base to "MTC."

Refer to page "125" for details about setting "MIDI SYNC OUT" in Setup mode.

Setting MTC OFFSET

1. Set the difference in time (offset time - less than six hours) from ABS time for "MTC OFFSET" in Setup mode.

Refer to page "127" for details on setting "MTC OFFSET" in Setup mode.

Setting frame rate

1. Select the same MTC frame rate as that of the sequencing software application for the "FRAME RATE" parameter in Setup mode.

Refer to page "126" for details on setting "FRAME RATE" in Setup mode.

Setting the device ID number

1. Select the same MMC device number (and the Fostex System Exclusive Message Device number) as that of the sequencing software application for the "dEvicE" parameter in Setup mode.

You do not need to set this parameter if the sequencing software is sending "7F", which means "ALL DEVICES."

Refer to page "134" for details on setting "dEvicE" in Setup mode.

Checking synchronization and machine control

1. Run the DMT-8vL in record mode to confirm that the sequencing software application synchronizes with the DMT-8vL MTC output. (You do not need to record any particular sound because this step just makes an already-recorded disk area.) (If data has already been recorded up to the end point of the song, simply play back the DMT-8vL.)
Also, check to see that the DMT-8vL responds correctly when you use the PLAY, STOP, or LOCATE function on the computer.

<Note>

If a recording was made only to create an accessible disk area or no recording has been made, MIDI clock will not be output and sync operation is not possible.

Overdubbing

1. Overdub performance data to Tracks 1-8, as explained in "MIDI Clock synchronization system."

Mixdown while synchronizing a MIDI sound source

Connect a MIDI sound source as shown in the figure below in the same way as described in the "MIDI Clock Synchronization System," to synchronize Tracks 1-8 playback data to the MIDI sound source, then apply effects and mix down.

*** Do not forget to read the following section.***

About the MMC REC Out function

Using the MMC REC out function, you can send the MMC command from the MIDI OUT connector in response to your operation on the DMT-8vL.

For example, pressing the PLAY button and the RECORD button simultaneously will output the MMC REC command from the MIDI OUT connector.

The following types of MMC commands will be output.

Operation on the DMT-8vL	Output MMC command (Device Number = 7F fixed)
PLAY + RECORD buttons	REC command
Punch in operation in Take mode of AUTO PUNCH IN/OUT	
Punch in operation via a footswitch	
RECORD button ON/OFF	Input monitor ON/OFF command
Rehearsal IN in rehearsal mode of AUTO PUNCH IN/OUT	
Rehearsal IN via a footswitch	
PLAY button	REC EXIT command
Punch out in Take mode of AUTO PUNCH IN/OUT	
Punch out via a footswitch	
STOP button	STOP command

These MMC commands will be output in response to button operations on the DMT-8vL. Therefore, operating the DMT-8vL via an MMC command sent from the external device will not cause the DMT-8vL to output any MMC commands.

You cannot turn off the MMC REC out function. If you operate any button on the DMT-8vL, it will always output an MMC command. You cannot set the DMT-8vL in a mode in which it does not output any MMC commands.

For this reason, while the sequencer is connected to the DMT-8vL's MIDI OUT and is set to record mode, operating the DMT-8vL will cause MMC commands to be recorded in the sequence track. In this case, please note that sending sequence data from the sequencer's MIDI OUT to the DMT-8vL's MIDI IN will cause the DMT-8vL to perform the operation according to the sequence data (for example, the DMT-8vL may be engaged in record mode).

4. Synchronizing multiple DMT-8vLs in Slave mode

This section explains how to configure a 16-channel/16-track system using the Slave mode function of the DMT-8vL. As an example, we will synchronize one slave DMT-8vL to the master DMT-8vL digital multitracker.

- * Set the DMT-8vL to the default setting.
- * Make sure that you have selected an appropriate Program number.

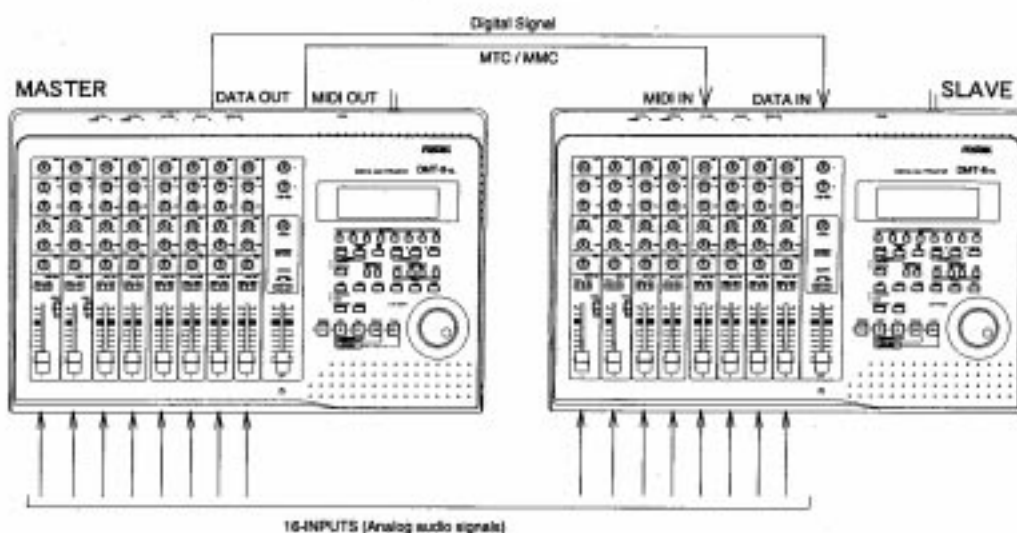

Connection

1. Connect the master DMT-8vL MIDI OUT to the slave DMT-8vL's MIDI IN. Connect the master DMT-8vL DATA OUT to the slave DMT-8vL's DATA IN using an optical cable.

Master DMT-8vL setting

1. Set "MIDI SYNC OUT" in SETUP mode to "mtc" and set "MTC OFFSET" and "FRAME RATE" to a desired value for the offset value and the frame rate value.

* Refer to pages "125", "126" and "127" of the Setup mode section for details.

Slave DMT-8vL setting

1. Set the "MTC OFFSET" and "FRAME RATE" parameters of the slave DMT-8vL to the same value as those of the master DMT-8vL.
2. Set the slave DMT-8vL's "SLAVE" setting in Setup mode to "on."
When "on" is selected, the CHASE display will blink. (This means that Slave mode has been set to "on" but synchronization has not been established. When synchronization is established, the LED will light up.)
The slave DMT-8vL's "DIGITAL" indicator will light up once digital signal output from the master machine is read correctly. (The message will blink if the signal is read incorrectly.)

<Note>

To operate multiple DMT-8vLs in slave mode, route the MTC output from the master device to the MIDI IN connector of the slave machine, using a MIDI thru box.

For a digital signal, connect the first slave DMT-8vL's DATA OUT connector to the second slave DMT-8vL's DATA IN connector using an optical cable.

Checking the sync operation**1. Press the PLAY button on the master DMT-8VL to start playback.**

When the slave DMT-8VL starts reading the MTC signal from the master device correctly, and synchronization is subsequently established, the blinking CHASE display on the slave machine will light up.

Recording

A master DMT-8VL can output the MMC command from the MIDI OUT terminal to a connected slave machine while the master device is operating.

The slave machine will start recording in sync with the master DMT-8VL when you press the RECORD button and the PLAY button simultaneously or when you press the foot switch of the master device that is outputting the MMC command.

The slave machine will also start recording when you start punch-in recording on the master device. Pressing the PLAY button or foot switch, or punching out in Auto Punch mode on the master device during recording, will cause the slave machine to punch out. Also, you can turn input monitoring on or off, turn the foot switch rehearsal on or off, and Auto Punch mode rehearsal on/off by using the RECORD button. (Operation on the master device will control the slave machine as follows:)

Operation on the master device	Operation of the slave device
Pressing the RECORD button and the PLAY button	Record mode (punch in)
Punching in during Auto Punch mode	
Punching in using the foot switch	
Turning the RECORD button on/off	Input monitor and rehearsal on/off
Rehearsal on/off in Auto Punch mode	
Rehearsal on/off using the foot switch	
Using the PLAY button during recording	Cancel recording (punch out)
Punching out in Auto Punch mode	
Punching out using the foot switch	
Press the STOP button	Stop

<Note>

The slave machine will enter record mode even if its slave mode has been turned off.

Set "Slave Mode" of the slave machine to "ON" to synchronize the slave machine to the master DMT-8VL for recording.

<Note>

You can perform normal recording and punch in/out recording on the slave DMT-8VL alone even while it is syncing to an external MTC signal (and digital signal). You can set "MIDI SYNC OUT" at any time regardless of the slave mode on/off setting of the DMT-8VL.

The DMT-8VL Rebase window is fixed at "10 frames". That is, if the digital signal sent to the slave machine is interrupted (or if you try to perform a sync operation using only the MTC, without sending any digital signal), the slave DMT-8VL will continue syncing as long as the offset between the master and slave position is within 10 frames. However, if the offset exceeds 10 frames, the slave machine will adjust the position in relation to the master device position. (This is called a "Rebase operation.") Audio output will be muted during the rebase operation.

<Note>

If the slave machine receives the MMC REC command but does not lock to the master device, the slave machine will hold the REC command for a moment until it locks to the master device to start recording. However, if it takes more than two seconds for the slave machine to lock to the master device, the REC command (only MMC command) will be cancelled.

<Note>

When the slave machine receives an MMC REC command and has not locked to the master device, the slave machine will hold the REC command temporarily and wait until it locks to the master device before starting to record. However, if it takes two seconds or longer for the slave machine to lock to the master device, the REC command (MMC command only) will be cancelled.

5. Using only the recorder section on the DMT-8vL

You can use the internal hard disk recorder alone. Connect the group out of the external mixing console (that has eight monitor mix channels) to the RECORDER IN connector of the DMT-8vL, and connect the DMT-8vL RECORDER OUT jack to the tape in connector (x8) of the external mixer.

Since the DMT-8vL has two RECORDER IN jacks for 1/3/5/7 and 2/4/6/8, it may be a good idea to use a patch-bay so that you can change connection from the front.

- * Set the DMT-8vL to the default setting.
- * Make sure that you have selected an appropriate Program number.

<Note>

If you have connected any plug to the RECORD IN jack on the DMT-8vL, the connected device will have priority and you will not be able to record data via the INPUT faders.

If you wish to record data using the DMT-8vL mixer function, be sure to remove an inserted plug from the RECORDER IN jack.

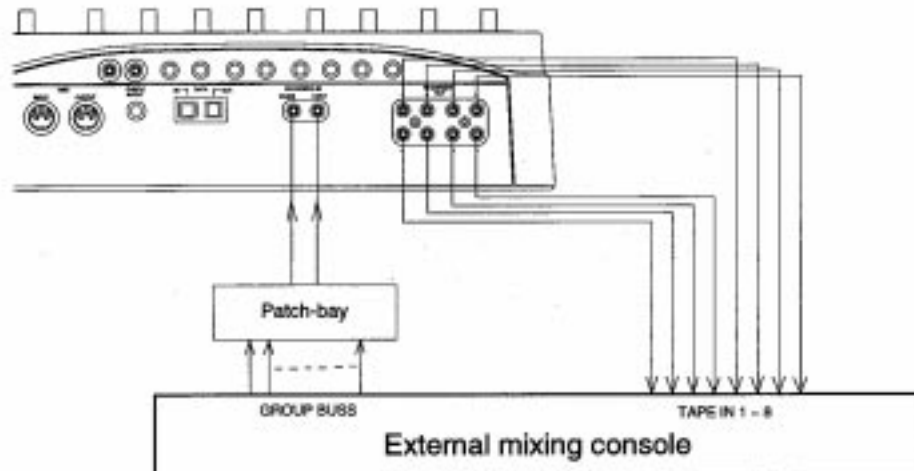

<Notes>

The L/R level meter and the digital output will operate as follows when recording data from the RECORDER IN connectors:

1. Using both the 1/3/5/7 and 2/4/6/8 connectors:

dG out (digital out) = set to "SI"	
L/R level meter	Shows the input level at the RECORDER IN connectors.
Digital output	Outputs the signal input from the RECORDER IN connectors.
dG out (digital out) = set to something other than "SI"	
L/R level meter	Shows the output level of the track (that is set to "dG out") as L (odd-numbered track) and R (even-numbered track)
Digital output	Outputs the signal of the track set to "dG out."

2. Using either the 1/3/5/7 or 2/4/6/8 connector:

dG out (digital out) = set to "SI"	
L/R level meter	"L" shows the RECORDER IN input level if the 1/3/5/7 connector is used, and "R" shows the input level if the 2/4/6/8 connector is used.
Digital output	If the 1/3/5/7 connector is used, the L output will output the signal input from the 1/3/5/7 connector, and the R output will output the signal after the master faders L/R. If the 2/4/6/8 connector is used, vice versa.
dG out (digital out) = set to something other than "SI"	
L/R level meter	Shows the output level of the track (that is set to "dG out") as L (odd-numbered track) and R (even-numbered track)
Digital output	Outputs the signal of the track set to "dG out."

6. Four-tracks simultaneous recording using the digital recording function

As well as digital recording from an external device (as described in Chapter 6 of the Basic Guide), you can simultaneously make an analog recording to other tracks that are "readied." This means that if you use a DAT machine or MD device, you can perform four-track simultaneous recording (two analog tracks and two digital tracks).

At this time, the L/R level meters will not respond, although you can make a standard analog recording. In this example, you can check the recording level of Tracks 3 and 4 with level meters 3 and 4.

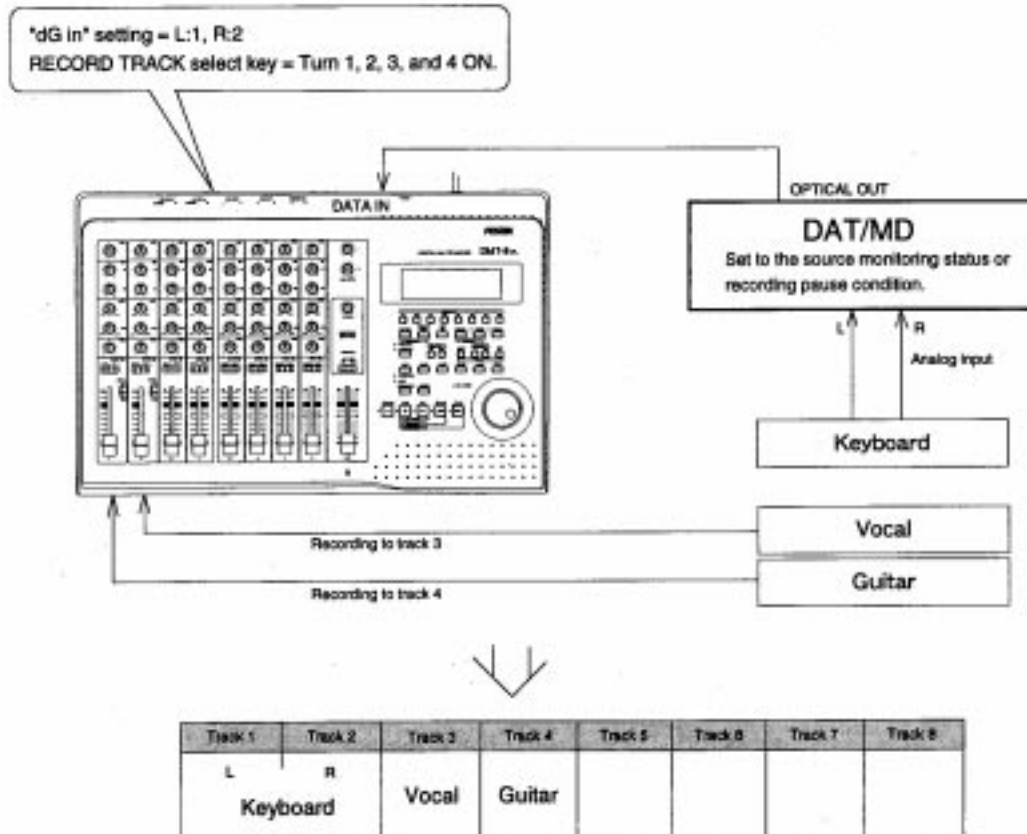

Punch In/Out

Punch In/Out recording is used to re-record data onto a certain area of a pre-recorded track. For example, you can replace a phrase from your guitar solo with a better performance.

There are two ways to Punch In/Out record: Auto Punch In/Out recording, in which you specify the Punch In/Out points; and Manual Punch In/Out recording, in which you use optional foot switch Model 8051. In either case, the Rehearsal function allows you to practice before actual take. Using the Punch In/Out recording technique, you can easily and quickly replace mistakes or phrases you do not like with more desirable takes. Choose one of these methods to suit your preferences and applications.

- The example here explains how to replace "part of the guitar solo" recorded on Track with a new phrase by playing the guitar (connected to Input jack 1), while listening to the drum and bass sound recorded on Tracks 1 and 2. Once you master Punch In/Out recording, you can use this technique for other tracks.
- Assume that the guitar is connected to the mixer input, and that the output signal from the mixer is routed to Track 3 of the DMT-8VL.
- Do not change the Program until a series of punch in/out operations is complete.
- First make sure that the DMT-8VL is set to the default setting.

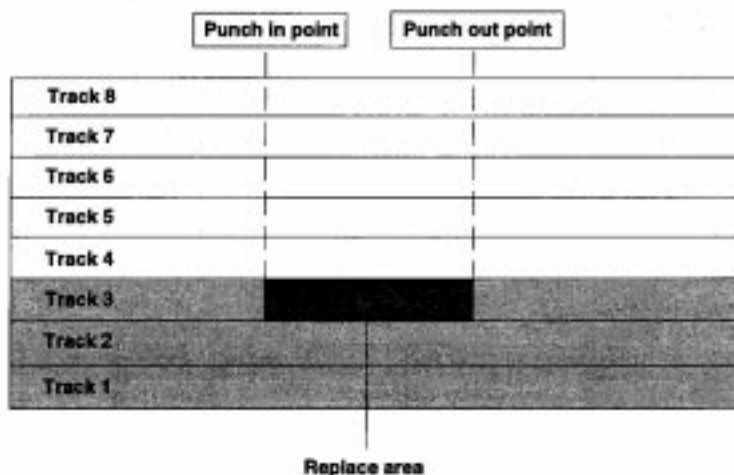

1. Auto Punch In/Out

To perform Auto Punch In/Out recording, first you need to specify the In point (recording start point) and the Out point (recording end point).

Once these two points are stored, the DMT-8vL automatically starts recording at the In point and stops recording at the Out point while the recorder is in "Take mode."

When you use the Auto Punch In/Out function, you can select "Rehearsal mode" to practice to your satisfaction before you record.

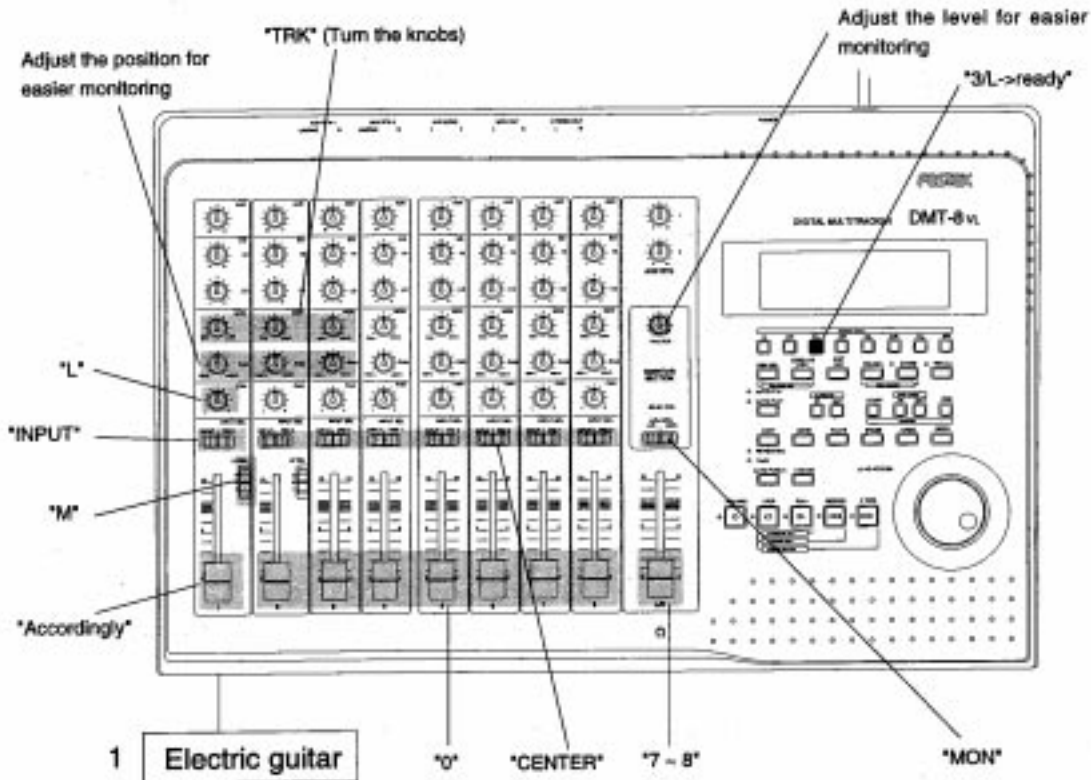

Preparation

1. Connecting the guitar to input jack 1.

Refer to "Basic Recording" for more information on adjusting the recording level.

Switch settings

INPUT SEL switch	Channel 1: *INPUT* Channel 2 - 8: *OFF* (center position)
INPUT fader & LEVEL switch	Channel 1: *Accordingly*, LEVEL: *M*, Channel 2 - 8: *0*
PAN knob (channel 1)	*L* (Turn the knob full counter-clockwise.)
MON knobs	Channel 1 - 3: *TRK 1*, *TRK 2*, *TRK 3* (Turn the knobs)
MON PAN knobs	Channel 1 - 3: Adjust the position for easier monitoring.
MASTER knob on the monitor section	Adjust the level for easier monitoring
SELECTOR switch on the monitor section	Set to *MON*
MASTER fader L/R	Set to *7 - 8*
RECORD TRACK select key	Press *3/L* to ready Track 3.

Storing the Punch Out point

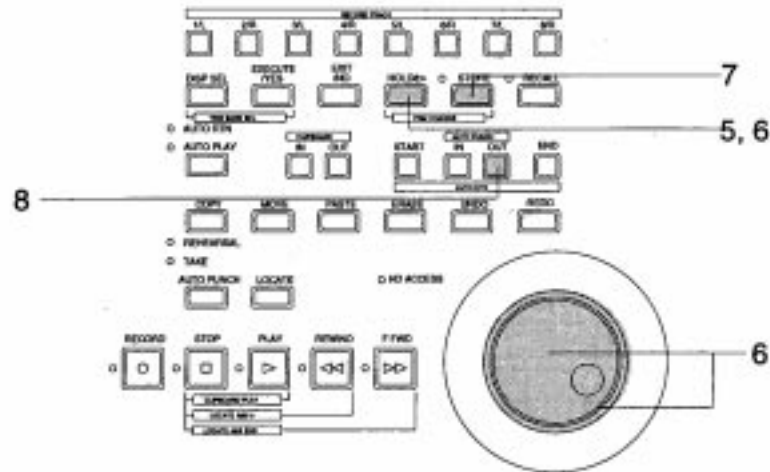

5. Press the HOLD/> key to enter edit mode.

000
00 u 02 u 40 u 0 Blink (Edit is possible)
03 , 28 u

6. Press the HOLD/> key or turn the SHUTTLE dial to select the digit you wish to edit, then use the JOG dial to change the time value.

000
00 u 03 u 35 u
15 , 00 u

7. Press the STORE key. (The STORE LED will light up.)

8. Press the AUTO PUNCH OUT key.

The specified time value will be stored as a Punch Out point, and the STORE LED will go off.

* To check the stored Punch In/Out point, press the RECALL key, then press the AUTO PUNCH IN key and/or the AUTO PUNCH OUT key. Alternatively, press the AUTO PUNCH IN/AUTO PUNCH OUT key. The display will show the stored time value.

<Note>

You cannot set the Punch Out point before the Punch In point location.
If the Punch Out point precedes the Punch In point and you try to "punch in," the message "Void out" appears on the screen immediately after you press the AUTO PUNCH key, indicating that the time value of the Punch Out point is inappropriate. Be sure to specify a larger value for the Punch Out point than for the Punch In point.

Auto Punch In/Out Rehearsal mode

In Rehearsal mode, the "READY" track enters input monitoring status between the Auto Punch In and Out points. Unlike Take mode, which is explained later, the recorder will not record any data, allowing you to fine-tune the In/Out points or the recording level until the settings are satisfactory.

Rehearsal operation

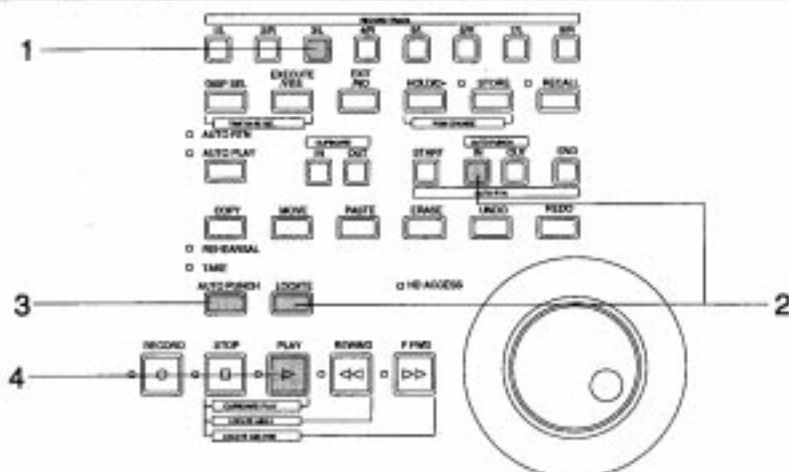

1. Press the RECORD TRACK select key "3" to set Track 3 in "ready" mode. ("3" on the display will blink.)

2. Locate a point just before the Punch In point, using one of the following methods:

Press the AUTO PUNCH IN key, then the LOCATE key.

The display will show the Punch In point time, and the Punch In point will be located immediately. Press the REWIND button or turn the SHUTTLE dial counter-clockwise to rewind a little.

Alternatively, you can store the playback start point (time) at the AUTO RTN START for the future locate operations. (You need to use the AUTO RTN START key for step 4 of "Storing the Punch In point.")

3. Press the AUTO PUNCH key. (The REHEARSAL (green) and TAKE (red) LEDs will light up.)

If there is not enough space on the disk for the undo operation, the display will show the "overtime indication" and the "CAN'T UNDO" indication. Refer to "Warning Message" in the "Display Section" for details.

4. Press the PLAY button.

Rehearsal mode is engaged as shown on the next page.

5. Rehearse the guitar part while listening to the playback sound of Track 1 and 2 (drums and bass), and adjust the recording level.

Between the Punch In and Out points, you will hear the guitar part that you are playing. Otherwise, you will be monitoring the previously-recorded sound.

Use the INPUT fader to adjust the level of the guitar. To adjust the playback level to Track 1 ~ 3, turn the corresponding MON knobs toward "TRK."

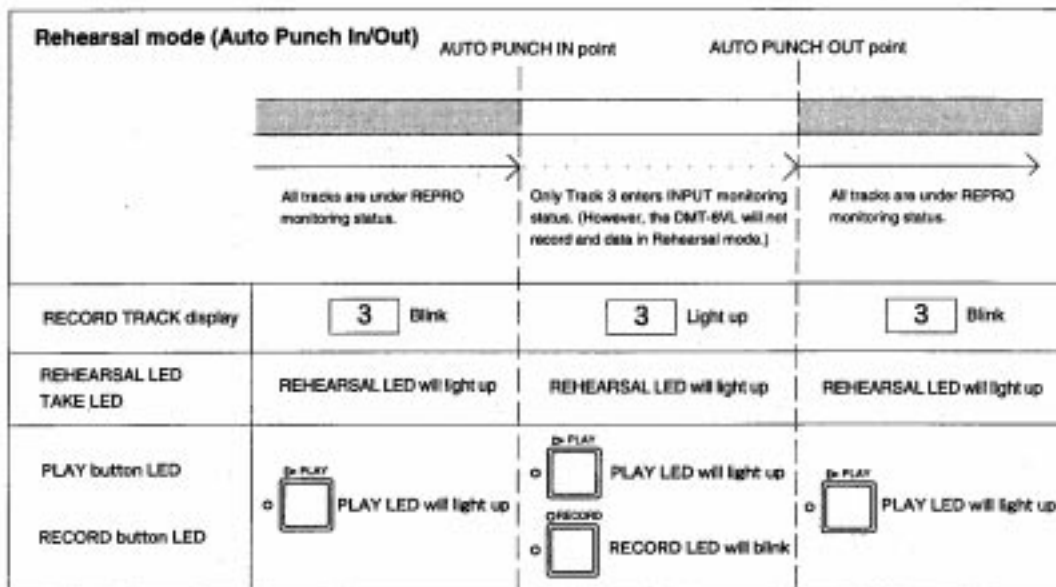

*** Hints**

When you are rehearsing repeatedly, it is an effective time-saver to use the Auto Return function along with the Auto Play function.

As shown in the diagram below, specifying the Start and End points for the Auto Return and Auto Play functions allows you to easily rehearse as many times as you like. This enables you to pay more attention to the recording level and your own performance. Refer to pages "89" - "91" for more information on setting the Start/End points for the Auto Return/Auto Play functions.

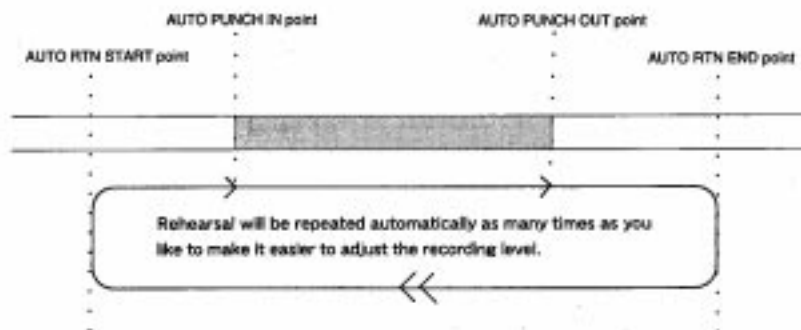

Auto Punch In/Out Take mode (actual recording)

Take operation

1. As in Rehearsal mode, locate the point just before the Punch In point.
Assume that Auto Punch mode is on; that is, both REHEARSAL and TAKE LEDs are blinking.
2. Press the RECORD button while pressing and holding down the PLAY button.
The REHEARSAL LED will go off and the TAKE LED will light up.
3. Play the guitar while listening to the playback sound.
As shown in the illustration below, the recorder will start recording automatically at the Punch In point, and stop recording at the Punch Out point.

* When recording is finished, Auto Punch mode will be cancelled, and both REHEARSAL and TAKE LEDs will go off.

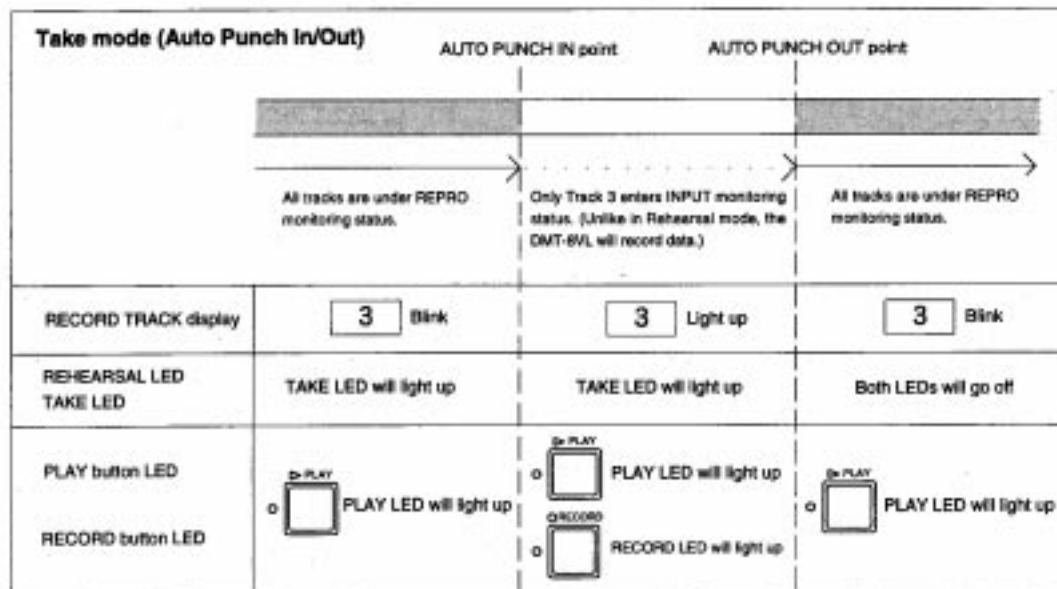

Undo/Redo of Auto Punch In

When you auto punch in/out record while the "CANT UNDO" warning message is not displayed, you will be able to undo or redo the take.

Pressing the UNDO key after recording will restore the status obtained before you made Punch In/Out recording. Pressing the REDO key will restore the status obtained before you pressed the UNDO key.

<Note>

You can use the undo/redo functions while the DMT-8vL is in stop mode.

Under the following circumstances, you will be unable to use the undo/redo functions;

1. if you make a new recording,
2. if you make a new edit (copy & paste, move & paste, erase, or cut),
3. if the Auto Punch In point was passed in play or record mode while Auto Punch mode was on, or
4. if you turned off the power to the DMT-8vL, then turned it back on.

2. Punch In/Out Recording using a foot switch

"Take mode" and "Rehearsal mode" are also available in this application. Pressing the foot switch repeatedly while holding down the STOP button will toggle between "take" and "rehearsal." The REHEARSAL LED of the AUTO PUNCH key will blink during Rehearsal mode, and the LED will be off during "Take mode."

1. Select the track onto which you wish to punch in/out record.
2. Start playback just before the punch in point.
3. Press the foot switch when you want to start recording.
4. Press the foot switch again when recording is finished.

In this lesson, we are going to replace part of the guitar solo recorded on Track 3, as we did in the Auto Punch In/Out section.

- * Set the DMT-8VL to the default setting.
- * Use an optional foot switch Model 8051 for punch in/out recording.
- * Set Auto Punch mode to OFF. (The REHEARSAL LED and the TAKE LED will be turned off.)
- * First, select a desired Program.

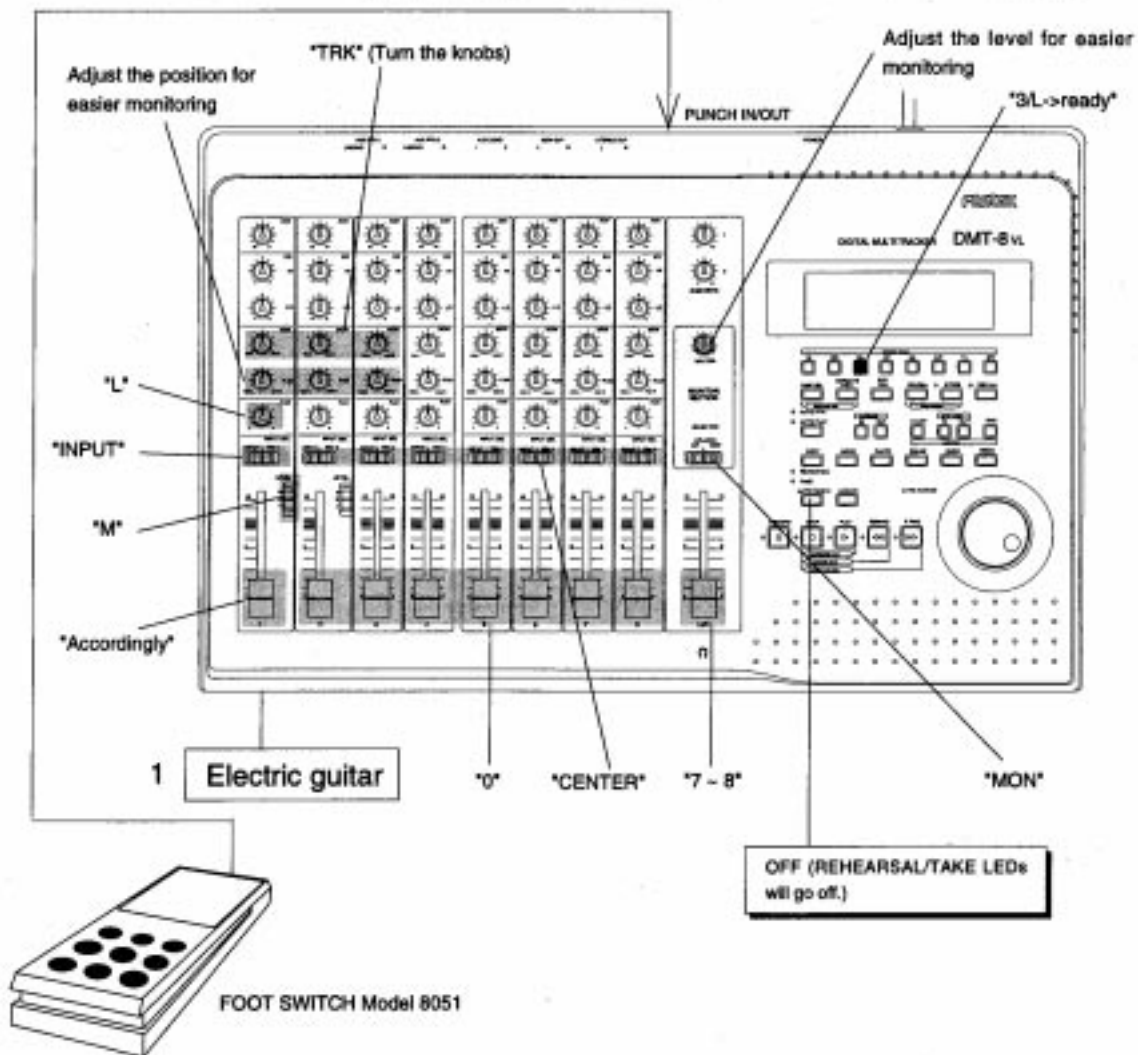

Preparation

1. Connect the guitar to Input jack 1.
Refer to "Basic Recording" for more information on adjusting the recording level.
2. Connect the foot switch Model 8051 to the PUNCH IN/OUT jack on the rear panel of the DMT-8vL.

Switch setting

INPUT SEL switch	Channel 1: "INPUT" Channel 2 - 8: "OFF" (center position)
INPUT fader & LEVEL switch	Channel 1: "Accordingly", LEVEL: "M", Channel 2 - 8: "0"
PAN knob (channel 1)	"L" (Turn the knob full counter-clockwise.)
MON knobs	Channel 1 - 3: "TRK 1", "TRK 2", "TRK 3" (Turn the knobs)
MON PAN knob	Channel 1 - 3: Adjust the position for easier monitoring.
MASTER knob on the monitor section	Adjust the level for easier monitoring.
SELECTOR switch on the monitor section	Set to "MON"
MASTER fader L/R	Set to "7 - 8"
RECORD TRACK select key	Press "3/L" to ready Track 3.

Punch In/Out Rehearsal (Using a foot switch)

Rehearsal operation

1. Press the foot switch once while holding down the STOP button.
The recorder enters "Rehearsal" mode, and the 7-segment display on the upper row of the screen will show "REHSAL", and the 7-segment display on the bottom row will show "on" for one second. Only the REHEARSAL LED (green) will blink.
2. Press the PLAY button at a location just before the punch in point to play back data.
3. Rehearse the guitar part while playing back the drum and bass sounds.
4. Press the foot switch once at the Punch In point, and press the foot switch again at the Punch Out point. The following diagram illustrates this operation.
You will hear the guitar sound you are playing only between the punch in and out points.

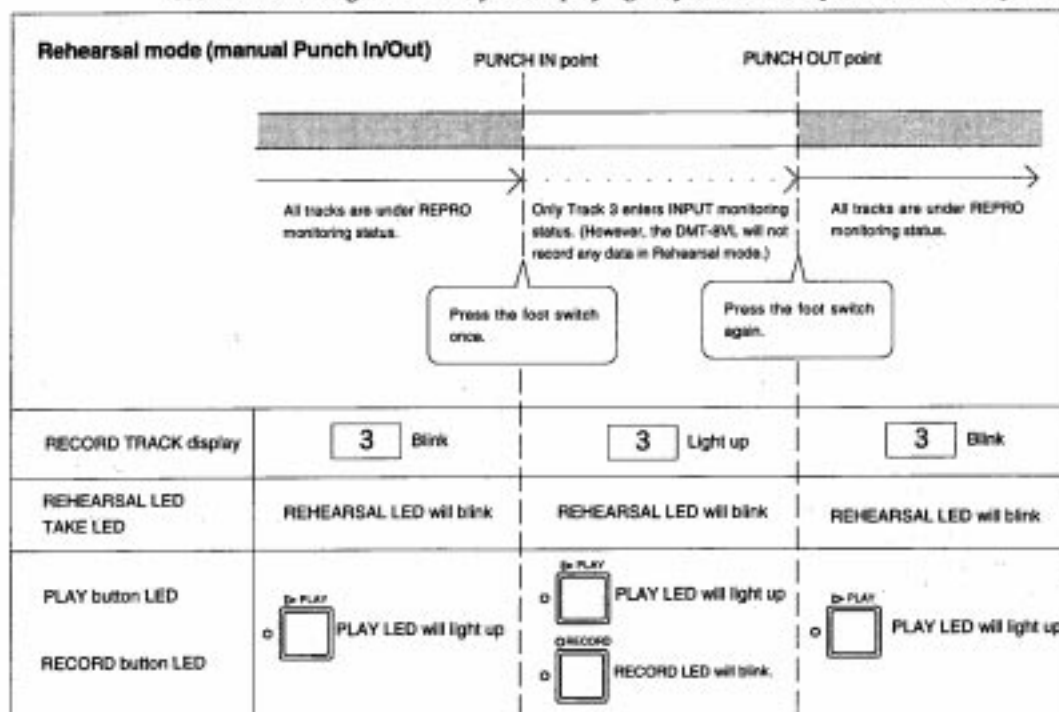

End of rehearsal

1. Press the foot switch again while holding down the STOP button to cancel Rehearsal mode. The 7-segment display on the upper row of the screen will show "rEHSAL", and 7-segment display on the bottom row will show "oFF" for one second. Also, the REHEARSAL LED (green) will turn off, indicating that you quit Rehearsal mode.

* Hints

When you are rehearsing repeatedly, it is an effective time-saver to use the Auto Return function along with the Auto Play function.

As shown in the diagram below, specifying the Start and End points for the Auto Return and Auto Play functions allows you to easily rehearse as many times as you like. In this way, you can pay more attention to the recording level and your own performance. Refer to pages "89" - "91" for more information on setting the Start/End points for the Auto Return/Auto Play functions.

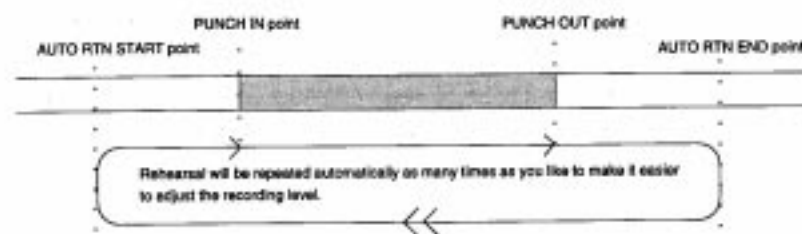

Punch In/Out Take (manual Punch In/Out)

Take operation

1. Locate the point just before the punch in point and play back the data.
2. Play the guitar while listening to the playback.
3. Press the foot switch once at the punch in point, and press the foot switch again at the punch out point. When you finish punch out recording, the DMT-8vL will quit recording mode.

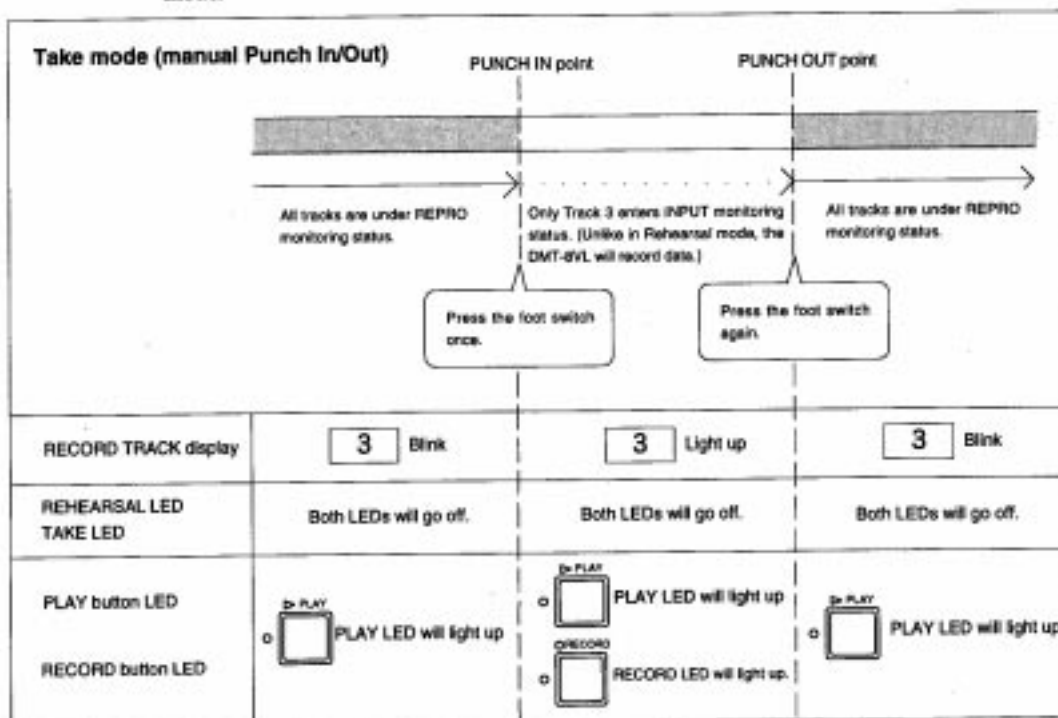

<Note>

Once you perform Punch In/Out recording using a footswitch, you need to stop the DMT-8vi before performing the next Punch In/Out take.

*** Hints**

Besides the foot switch, you can also use the PLAY button and RECORD button for Manual Punch In/Out recording. (Please note that you can use these buttons only once.)

1. Start playing back from a point just before the punch in point.
2. At the punch in point, press the RECORD button while holding down the PLAY button. (Punch In)
3. At the punch out point, press only the PLAY button. (Punch Out)

* You can also rehearse if you "press only the RECORD button" instead of steps 2 and 3 described above.

Locate Function

Since the DMT-8VL uses a hard disk as storage media, it can locate any point immediately. Using the Locate function allows you to quickly locate points stored at the CLIP BOARD IN/OUT key, AUTO PUNCH IN/OUT key, AUTO RTN START/END key, LOCATE key, or at the beginning of the hard disk (ABS TIME 0), or at the end of recording area (ABS TIME END).

This function is also very useful for rehearsal before recording, rehearsing during mixdown, and rehearsal for Auto Punch In/Out recording.

1. Locate

Use the following key sequences to locate a certain point. In this table, "+" indicates that you need to press the specified key while pressing and holding down the STOP button.

"->" indicates that you need to first press one key, then press a second key.

1	STOP+REWIND	Locates the beginning of the program (ABS 0).
2	STOP+F FWD	Locates the end of the recorded area on the program (ABS END).
3	CLIPBOARD IN->LOCATE	Locates the stored Clipboard In point.
4	CLIPBOARD OUT->LOCATE	Locates the stored Clipboard Out point.
5	AUTO RTN START->LOCATE	Locates the stored Auto Return Start point.
6	AUTO RTN END->LOCATE	Locates the stored Auto Return End point.
7	AUTO PUNCH IN->LOCATE	Locates the stored Auto Punch In point.
8	AUTO PUNCH OUT->LOCATE	Locates the stored Auto Punch Out point.
9	LOCATE	Locates the stored Locate point (see the note below).

<Note>

Please note that each time you use any locate functions other than operations 1, 2, and 9 shown above, the located point data will automatically replace the existing data at the LOCATE key. For example, assume that the LOCATE key has stored data of 00H:05M:30S:00F:00SF. When the Auto Return Start point "00H:03M:00S:00F:00SF" is located, the data stored at the LOCATE key will be changed "00H:03M:00S:00F:00SF." You can check the data stored at the LOCATE key by pressing the RECALL key, then the LOCATE key. You can also edit the data using the JOG dial, and press the STORE key then the LOCATE key to store a locate point which can be accessed by only the LOCATE key itself.

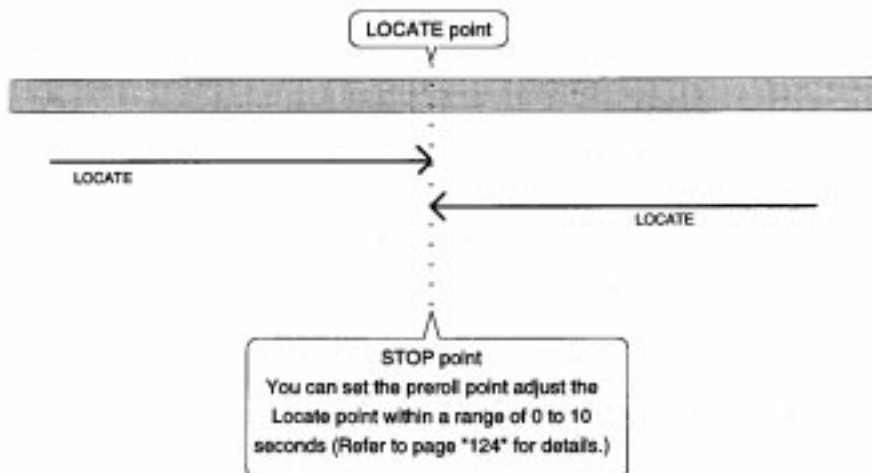

2. Auto Play mode

Turn Auto Play mode on before using the Direct Locate function, and the DMT-8vL will automatically start playback from the located point (except when the ABS END point is located). The diagram below illustrates this operation.

To turn Auto Play mode on, press the AUTO PLAY/AUTO RTN key so that the AUTO PLAY LED will light up. To cancel this mode, press the AUTO PLAY/AUTO RTN key again so that the AUTO PLAY LED will go off.

• Refer to page "23" "Names and Functions" for instructions on using the AUTO PLAY and AUTO RTN keys.

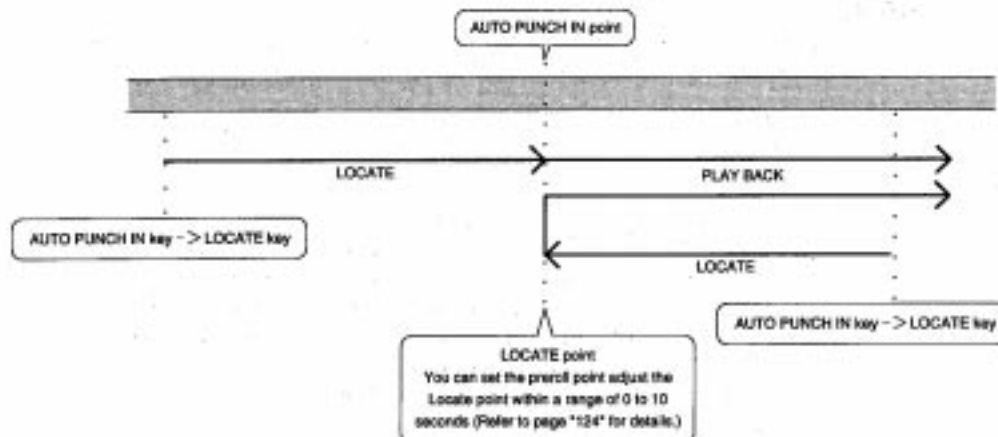

3. Auto Return mode

To turn Auto Return mode on, press the AUTO PLAY/AUTO RTN key so that the AUTO RTN LED will light up.

To use the Auto Return function, first you need to specify the Auto Return Start point and Auto Return End point.

As shown in the diagram below, the DMT-8vL will play back data to the Auto Return End point, then automatically locate the Auto Return Start point, and stop.

<Note>

The start point will not be locate after the AUTO RTN END point is reached when the DMT-8vL is in record mode.

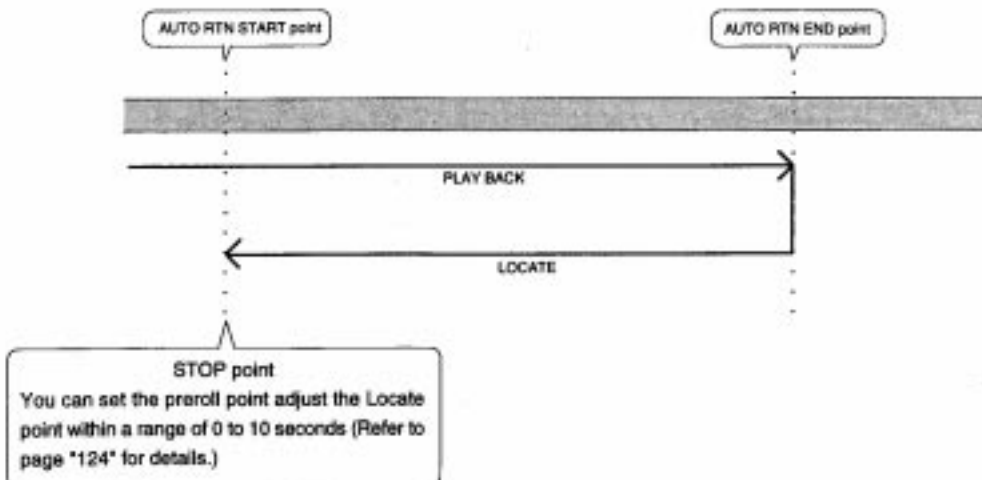

Setting the Auto Return Start/End point

There are two ways to set the Auto Return Start point and End point: one is to hold and store a desired time value in real-time during playback or while the DMT-8vL is stopped; the other is to edit and store a desired time.

Storing the Start/End point in real-time

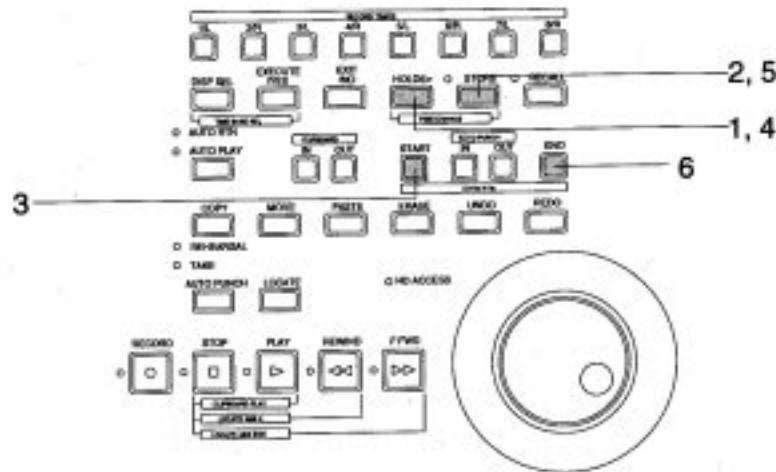

1. While the DMT-8vL is playing back or stopped, press the HOLD/> key at the location you wish to store as a Start point.
The time value obtained when you press the HOLD/> key will be held, and the DMT-8vL will enter edit mode.

* The display Resolution mode setting is available when BAR/BEAT/CLK is used for the Time Base. Refer to page "132" for details.

2. Press the STORE key. (The STORE LED will light up.)
3. Press the AUTO RTN START key.
The time value you held will be stored as a Start point, and the display will go back to the previous screen that was obtained before the time value was held. (The STORE LED will go off.)
4. Press the HOLD/> key again at the location you wish to store as an End point.
5. Press the STORE key. (The STORE LED will light up.)
6. Press the AUTO RTN END key.
The time value you held will be stored as an End point, and the display will go back to the previous screen that was obtained before the time value was held.

* In steps 1 and 4 described above, you can press the STORE key instead of the HOLD/> key, then press the AUTO RTN START/AUTO RTN END key to set the data more quickly.

Editing and storing the Start/End point

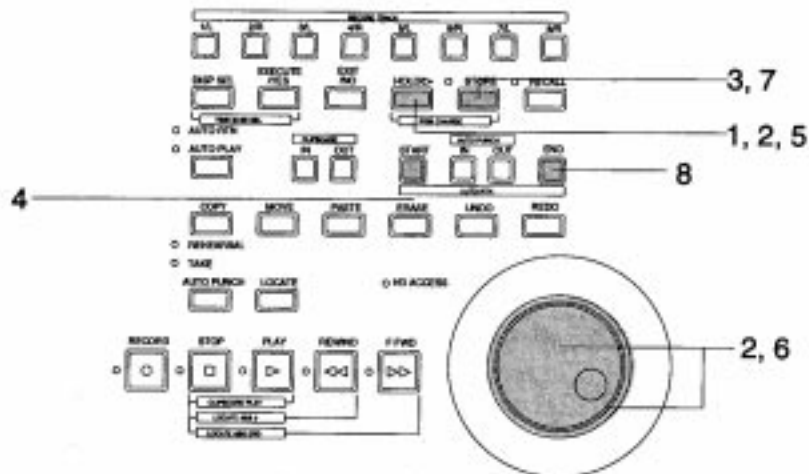

- 1. Press the HOLD/> key while the DMT-8vL is playing back or stopped.**
The time value at the moment when you pressed the HOLD/> key will be held and the unit will enter edit mode.

* The display Resolution mode setting is available when BAR/BEAT/CLK is used for the Time Base. Refer to page "132" for details.

- 2. Move the cursor to the time value (bar) using the HOLD/> key or SHUTTLE dial, and use the JOG dial to change the value.**
- 3. Press the STORE key.** (The STORE LED will light up.)
- 4. Press the AUTO RTN START key.**
The edited time value will be stored as a Start point, and the display will return to the screen displayed before you held the time value. (The STORE LED will go off.)
- 5. Press the HOLD/> key again.**
- 6. Enter the value as you did in step 2.**
- 7. Press the STORE key.** (The STORE LED will light up.)
- 8. Press the AUTO RTN END key.**
The edited time value will be stored as an End point, and the display will go back to the screen obtained previously before you held the time value.

* In steps 1 and 5 described above, you can press the STORE key instead of the HOLD/> key, edit the time value (bar), then press the AUTO RTN START/AUTO RTN END key to set the data more quickly.

Changing the stored Start / End points

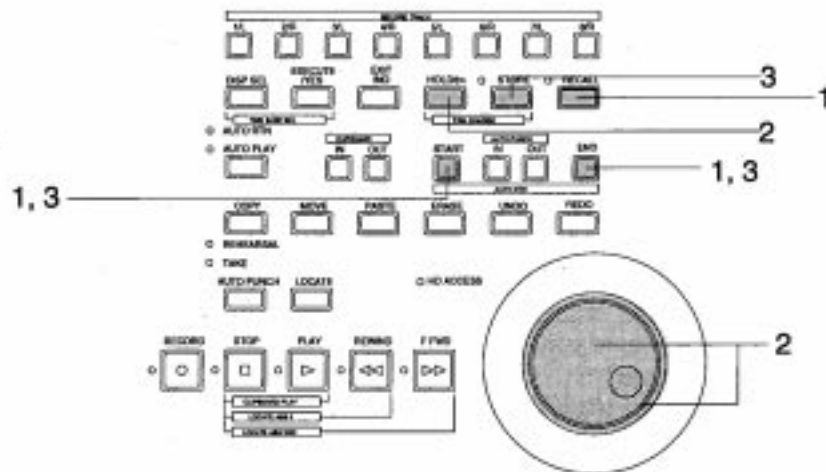

1. Press the **RECALL** key, then the **AUTO RTN START** key or **AUTO RTN END** key. (As a short-cut, you can press the **AUTO RTN START** key or **AUTO RTN END** key directly.)
The display will show the time value stored at the key, and the unit will enter edit mode.
2. Move the cursor to the time value (bar) using the **HOLD/>>** key or **SHUTTLE** dial, and use the **JOG** dial to change the value.
3. Press the **STORE** key, then press the **AUTO RTN START** key.
The edited time value will be stored as a Start point or End point.

<Note>

Pay attention to the location of the Start and End points. If you have set a larger value to the Start point than the End point while both Auto Return mode and Auto Play mode are on, the DMT-8vL will jump to the Start point and continue to play the rest of the data after playing to the End point (which is located before the Start point). Therefore, the repeat operation (explained later) will not be carried out correctly. Auto Return mode is effective only when the unit is in play mode.

4. Auto Repeat mode

The Auto Repeat function is a combination of Auto Play mode and Auto Return mode. To access the Auto Repeat function, press the AUTO PLAY/AUTO RTN key so that both AUTO RTN LED and AUTO PLAY LED will be lit.

You also need to set the Auto Return Start point and the Auto Return End point, as you did for the Auto Return function. (Refer to the previous section "Auto Return" for information on setting the Start and End points.)

With the Auto Repeat function, the DMT-8vl plays data up to the Auto Return End point, then automatically locates the Auto Return Start point, and plays back data between the Start and End points repeatedly, until you cancel the playback using the STOP button.

* Refer to page "23" of "Names and Functions" for instructions on using the AUTO PLAY and AUTO RTN keys.

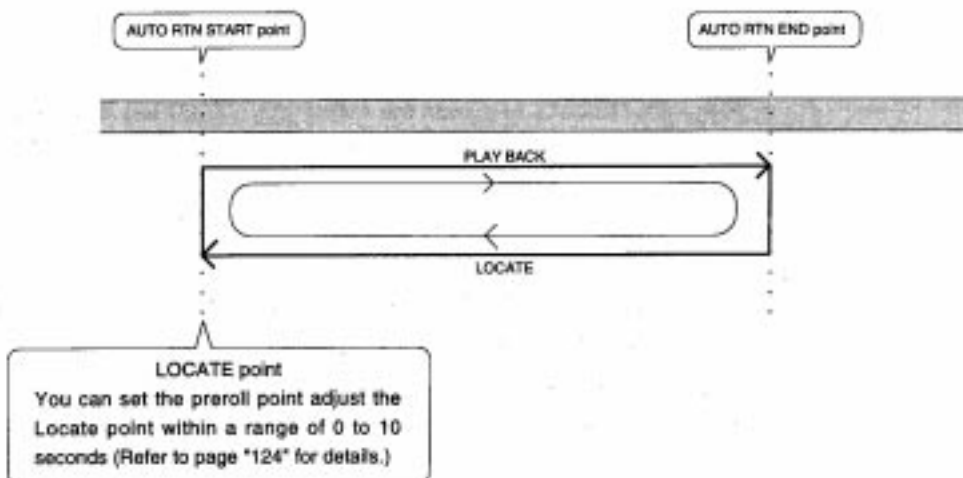

Hints:

When you are rehearsing Auto Punch In/Out recording, using the Auto Repeat function allows you to rehearse as many times as you want without tedious operations.

For example, by setting the Start point just before the Auto Punch In point and the End point just before the Auto Punch Out point, you do not worry about locating the data and can concentrate on rehearsing.

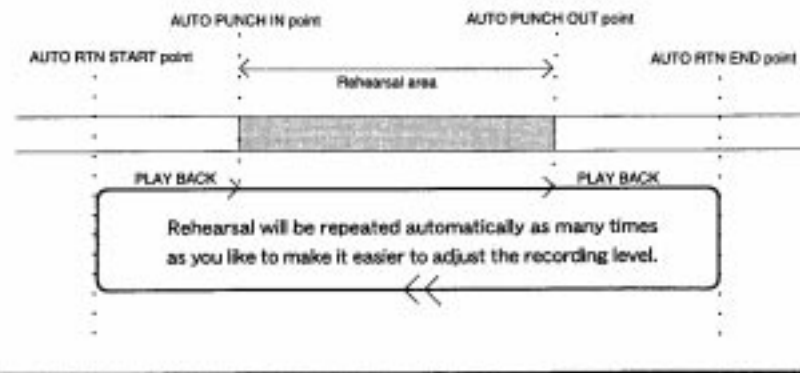

Edit Function

This chapter describes various editing functions on the DMT-8vL.

The DMT-8vL uses the hard disk as a recording media, which allows for non-linear, non-destructive, quick audio editing. The edit function includes the Copy & Paste, Move & Paste, Erase, and Cut functions.

<Precautions for editing>

The DMT-8vL contains Program 1-5, each of which can be separately recorded and edited. Before you start editing, confirm that you have selected a correct Program to edit by pressing the STORE key while holding down the HOLD/> key.

If you start editing the wrong Program, the original Program data will be lost forever. Be sure to check your Program selection before editing. Also, do not select another Program until all editing operation are complete.

Difference between Copy & Paste and Move & Paste

- The Copy & Paste function pastes data (that is copied on the Clipboards shown below) to any location of any track. The copy source data remains intact.
- The Move & Paste function is almost the same as the Copy & Paste, except that executing the Move & Paste function will erase the move source data (the Clipboard will be also cleared).

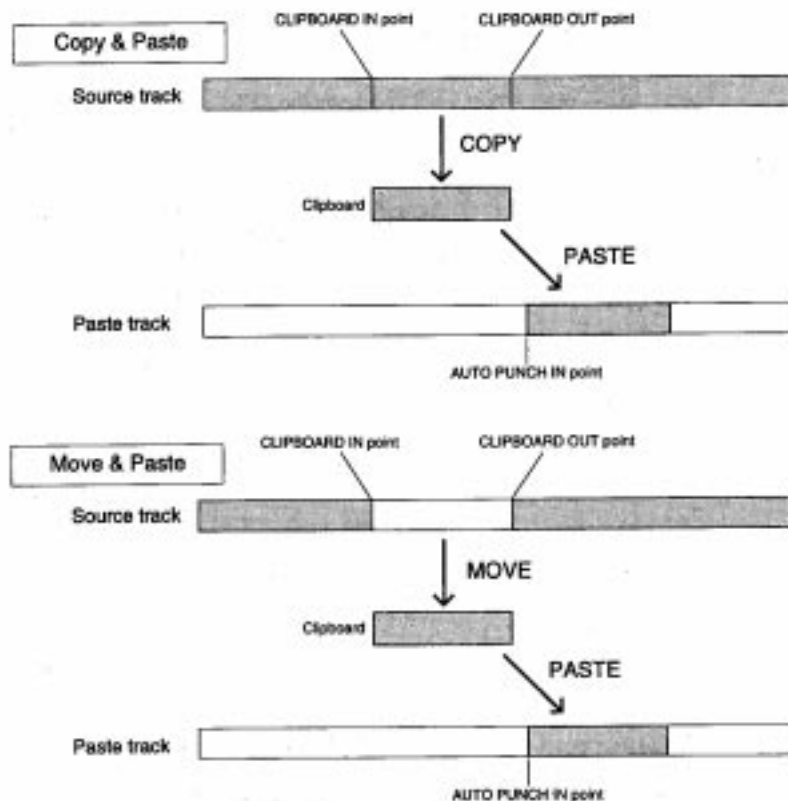

1. Copy & Paste

The Copy & Paste functions use the clipboard of the DMT-8VL, allowing you to copy sound data and paste it to the specified area. The copied data remains on the clipboard after you paste it, and you can paste the same data as many times as you want to different places. The Copy & Paste functions can reference any one of the following time bases: ABS time, MTC time, MIDI Bar/Beat/Clock.

- To perform the Copy operation, you first need to set the start point (Clipboard In point) and the end point (Clipboard Out point) of the copied data and the copy source track. To perform the Paste operation, you need to set the start point (Auto Punch In point) and the paste destination point.

<Note-1>

The data on the Clipboard will be replaced by new data each time you press the COPY key of the MOVE key.

<Note-2>

If pasted data overlaps the source data, the content of the source data will be altered.

Copying

First, you need to specify the area to be copied (using the Clipboard In/Out points and copy track).

- The following procedure is based on data with the ABS Time Base. To change the Time Base to MTC or MIDI BAR/BEAT/CLK, press the DISP SEL key while pressing and holding down the EXECUTE/YES key.

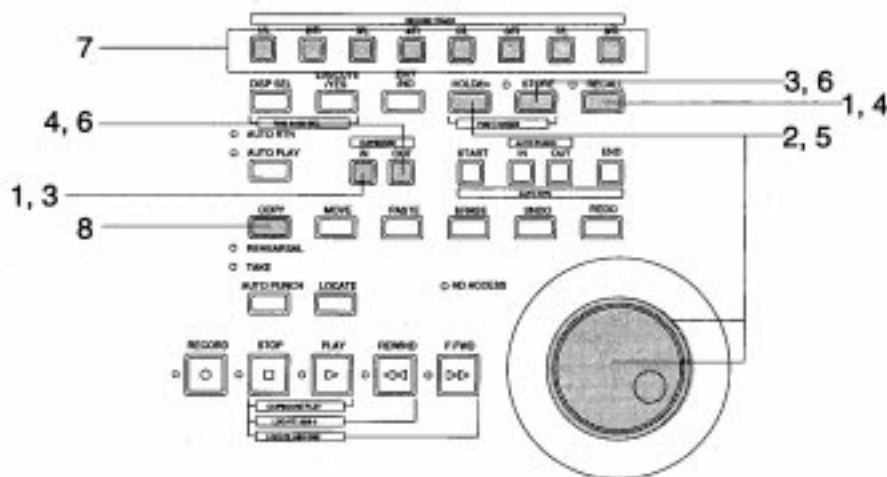

Entering and storing the CLIPBOARD IN point

- Press the RECALL key, then the CLIPBOARD IN key (or press only the CLIPBOARD IN key), and the unit will enter edit mode.
- Move the cursor to the digit you wish to change using the HOLD/> key or the SHUTTLE dial, and change the value using the JOG dial.

3. After setting the value, press the STORE key, then the CLIPBOARD IN key.

The time value will be stored as the Clipboard In time, edit mode will disengage, and the display will return to the previous screen.

Entering and storing the CLIPBOARD OUT point

4. Press the RECALL key, then the CLIPBOARD OUT key (or press only the CLIPBOARD OUT key), and the unit enters edit mode.

5. Move the cursor to the digit you wish to change using the HOLD/> key or the SHUTTLE dial, and change the value using the JOG dial.

6. After setting the value, press the STORE key, then the CLIPBOARD OUT key.

The time value will be stored as the Clipboard Out time, edit mode will disengage, and the display will return to the previous screen.

- * To check the stored In/Out points, press the CLIPBOARD IN key and CLIPBOARD OUT key respectively. The time value you just stored will be shown on the display.
- * You can perform steps 1-3 in real-time. (Pressing the STORE key, then the CLIPBOARD IN key while playing back the recorder will store data.)

Hints:

When you are storing the In/Out points in real-time while using the "BAR/BEAT/CLK" Time Base, you can store them in steps of beats if the "rESoLu" (Display Resolution mode ON/OFF) in Setup mode is "ON."

When this resolution mode is "ON," the CLK value will be rounded up or off to "00" (at the beginning of the beat) as soon as you press the STORE key. This function is useful when you wish to use the Copy & Paste or Move & Paste function in setups of beats. Refer to page "132" for detailed operation.

Copying the track data after storing the CLIPBOARD IN/OUT points

7. Select the copy track using the RECORD TRACK select keys (you can select multiple tracks).

- * You can select a mono track or multiple tracks.
When using the Copy & Paste function, however, you can change the paste destination track only when you have selected a mono track, or an odd-numbered track and the adjacent even-track (i.e.: 1-2, 3-4, 5-6, or 7-8).
If you have copied multiple tracks (other than the above combination), the data will be pasted to the copy source tracks. (track 1-> track 1.....track 3-> track 3 etc.)

8. Press the COPY key.

Copy is immediately completed. The display will show "COMPLETED" and return to the previous screen.

In this way, the specified part of the sound data of the selected track(s) is copied to the clipboard.

<Note 1>

If you press the COPY key without selecting a copy source track by the RECORD TRACK select key, the display will show "SELEct trk" (meaning "Select a copy track.") and return to the previous screen. In this case, select a copy source track and try again to copy the data.

<Note 2>

If the Output point has been specified before the In point (the In point value is the same or large than the Out point value), the display will show the error message "Void In" or "Void Out" and return to the previous screen. In this case, set correct In/Out points and try again to copy the data.

<Note 3>

The data on the Clipboard will be replaced by new data each time you press the COPY key or the MOVE key.

Listening to sound data copied on the clipboard (Clipboard Play function)

To listen to the sound data currently copied to the clipboard, press the PLAY button while holding down the STOP button (Clipboard Play mode).

The data will be played back from the beginning. To stop the playback in the middle, press the STOP button.

- * During the clipboard playback, the display shows the position of the source data referenced to the selected time base.

Copy & Pasting

You can paste data to the same track as the source.

For example, if you copied data on Track 1, data will be pasted on Track 1.

Data will be pasted starting from the Auto Punch In point.

<Note>

You need enough unrecorded space on the hard disk to execute the Copy & Paste operation. If you press the EXECUTE/YES key to try to paste data with insufficient disk space, the display will immediately show the error message "Over Time", then show the excess time using the currently-selected Time Base (time or bar). In this case, shorten the copy data by the amount of excess time. Alternatively, move ABS END backward using the CUT function as described in page "104" of this manual in order to obtain more free space on the hard disk.

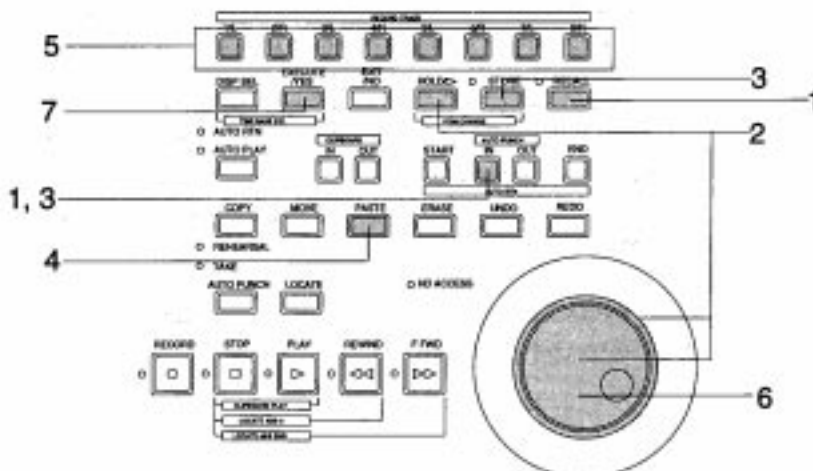

Entering and storing the paste Punch In point

1. Press the **RECALL** key, then the **AUTO PUNCH IN** key (or press only the **AUTO PUNCH IN** key), and the unit enters edit mode.
2. Move the cursor to the digit you wish to edit using the **HOLD/>** key or the **SHUTTLE** dial, and set the value using the **JOG** dial.
3. After setting the time value, press the **STORE** key, then the **AUTO PUNCH IN** key. The time value will be stored as the start point of the pasting area, and the display will go back to the previous screen.

Executing the paste operation

4. Press the **PASTE** key.

The display will show the blinking message "SURE?" and the bottom row of the 7-segment display will show "rPt 01" ("01" will blink) and "PAsT."

5. Specifying the copy destination track and the number of repeats to paste.

*** Specifying the Copy & Paste destination track:**

Select the destination track using the **RECORD TRACK** select key. (You do not need to specify the track if you are going to Copy & Paste data in the copy source track.)

*** Specifying the number of repeats to Copy & Paste:**

Turn the **JOG** dial to change the blinking number "01" to any value between 01 and 99. (If there is not enough free space on the hard disk, the repeat time will be limited to a number less than 99, and you will be unable to specify a larger number when you turn the **JOG** dial.)

6. Press the **EXECUTE/YES** key.

The upper row of the display will show the time taken for the Copy & Paste operation, then "CoPY", "PAsT", then "COMPLETED!". Press the **EXIT/NO** key to go back to the previous screen.

Now the audio data on the Clipboard has been pasted to the specified track starting with the **AUTO PUNCH IN** point.

For example, executing the function with a repeat number of "rPt 03" (three times) will paste the data as shown in the diagram below.

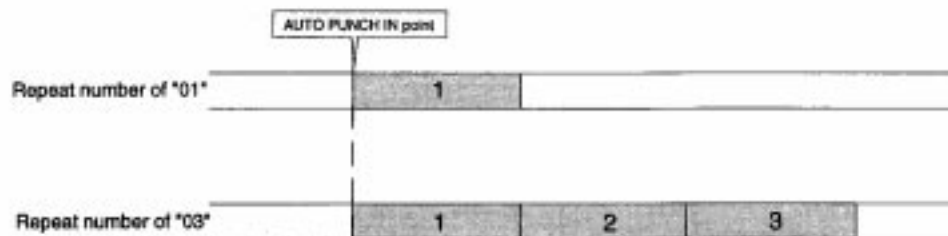

* To cancel the paste operation, press the **EXIT/NO** key while the message "SURE?" is blinking on the display.

If you wish to cancel the paste operation after you press the **EXECUTE/YES** key, press the **STOP** button or the **EXIT/NO** key before the "COMPLETED!" message appears on the display.

If you abort the paste operation using this procedure (even in the middle of the operation), no data will be pasted.

Copy & Paste Undo/Redo

If you wish to restore data that existed before you executed the Copy & Paste function, press the UNDO key to restore the status obtained before you pasted the data. Pressing the REDO key after pressing the UNDO key will restore the status before the Undo operation (that is, after pasting). The Undo and Redo functions are effective only while the DMT-8vL is stopped.

After the UNDO key or REDO key is pressed, the display will show "COMPLETED!" and return to the previous screen.

<Note>

You can use the undo/redo functions while the DMT-8vL is in stop mode.

Under the following circumstances, you will be unable to use the undo/redo functions:

1. if you make a new recording,
2. if you make a new edit (Copy & Paste, Move & Paste, Erase, or Cut),
3. if the Auto Punch In point was passed in play or record mode while Auto Punch mode was on, or
4. if you turned off the power to the DMT-8vL, then turned it back on.

2. Move & Paste

The Move & Paste function "moves" sound data to the Clipboard, and "pastes" the data in the same track or another track. You can specify the number of repeats of the paste operation (0-99) to paste data repeatedly.

The difference between the Copy & Paste and the Move & Paste operation is that after the Move & Paste operation the source data and the data on the Clipboard will be removed. You can use this function with any Time Base.

- * To perform the Move operation, you first need to set the start point (Clipboard In point) and the end point (Clipboard Out point) of the data to be moved, and the move source track. To perform the Paste operation, you need to set the start point (Auto Punch In point) and the paste destination point.

<Note>

The data on the Clipboard will be replaced by new data each time you press the COPY key or the MOVE key.

Moving

First, you need to specify the area to be moved (using the Clipboard In/Out points and move track).

- * The following procedure is based on data with the ABS Time Base. To change the Time Base to MTC or MIDI BAR/BEAT/CLK, press the DISP SEL key while pressing and holding down the EXECUTE/YES key.

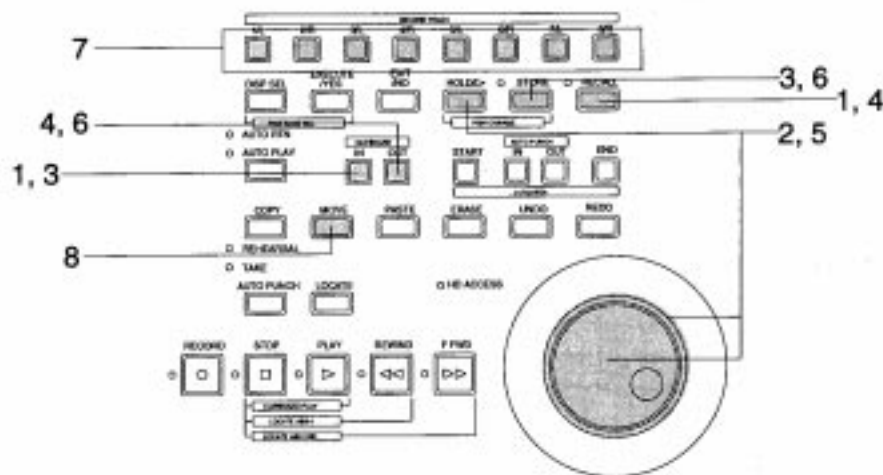

Entering and storing the CLIPBOARD IN point

1. Press the RECALL key, then the CLIPBOARD IN key (or press only the CLIPBOARD IN key), and the unit will enter edit mode.
2. Move the cursor to the digit you wish to change using the HOLD/> key or the SHUTTLE dial, and change the value using the JOG dial.
3. After setting the value, press the STORE key, then the CLIPBOARD IN key.
The time value will be stored as the Clipboard In time, edit mode will disengage, and the display will return to the previous screen.

Entering and storing the CLIPBOARD OUT point

4. Press the **RECALL** key, then the **CLIPBOARD OUT** key (or press only the **CLIPBOARD OUT** key), and the unit enters edit mode.
5. Move the cursor to the digit you wish to change the **HOLD/>** key or the **SHUTTLE** dial, and change the value using the **JOG** dial.
6. After setting the value, press the **STORE** key, then the **CLIPBOARD OUT** key.
The time value will be stored as the Clipboard Out time, edit mode will disengage, and the display will return to the previous screen.

- * To check the stored In/Out points, press the **CLIPBOARD IN** key and **CLIPBOARD OUT** key respectively. The time value you just stored will be shown on the display.
- * You can perform steps 1-3 in real-time. (Pressing the **STORE** key, then the **CLIPBOARD IN** key while playing back the recorder will store data.)

Hints:

When you are storing the In/Out points in real-time while using the "BAR/BEAT/CLK" Time Base, you can store them in steps of beats if the "rESoLu" (Display Resolution mode ON/OFF) in Setup mode is "ON."

When this resolution mode is "ON," the CLK value will be rounded up or off to "00" (at the beginning of the beat) as soon as you press the **STORE** key. This function is useful when you wish to use the Copy & Paste or Move & Paste function in steps of beats. Refer to page "132" for detailed operation.

Moving the track data after storing the CLIPBOARD IN/OUT points

7. Select the move track using the **RECORD TRACK** select keys (you can select multiple tracks).

- * You can select a mono track or multiple tracks.
When using the Copy & Paste or Move & Paste function, however, you can change the paste destination track only when you have selected a mono track, or an odd-numbered track and the adjacent even-numbered track (i.e.: 1-2, 3-4, 5-6, or 7-8). If you have moved multiple tracks (other than the above combination), the data will be pasted to the move source tracks. (track 1-> track 1.....track 3-> track 3 etc.)

8. Press the **MOVE** key.

Move is immediately completed.

The display will show "Move Clip" and "COMPLETED!" and return to the previous screen.

Now the sound data in the specified track has been moved to the Clipboard. At this point, the move source data has yet been deleted. It will be deleted after you perform the paste operation.

<Note 1>

If you press the MOVE key without selecting a move source track by the RECORD TRACK select key, the display will show "SELECT trk" (meaning "Select a move track.") and return to the previous screen. In this case, select a move source track and try again to copy the data.

<Note 2>

If the Output point has been specified before the In point (the In point value is the same or large than the Out point value), the display will show the error message "Void In" or "Void Out" and return to the previous screen. In this case, set correct In/Out points and try again to move the data.

<Note 3>

The data on the Clipboard will be replaced by new data each time you press the COPY key or the MOVE key.

Listening to sound data moved on the clipboard (Clipboard Play function)

To listen to the sound data currently moved to the clipboard, press the PLAY button while holding down the STOP button (Clipboard Play mode).

The data will be played back from the beginning. To stop the playback in the middle, press the STOP button.

* During the clipboard playback, the display shows the position of the source data referenced to the selected time base.

Move & Pasting

The data will be move & pasted at the point stored in the Auto Punch In key. You can select the paste destination track the RECORD TRACK select key.

<Note>

You need enough unrecorded space on the hard disk to execute the Move & Paste operation. If you press the EXECUTE/YES key to try to paste data with insufficient disk space, the display will immediately show the error message "Over Time," then show the excess time using the currently-selected Time Base (time or bar). In this case, shorten the move data by the amount of excess time. Alternatively, move ABS END backward using the CUT function as described in page "104" of this manual in order to obtain more free space on the hard disk.

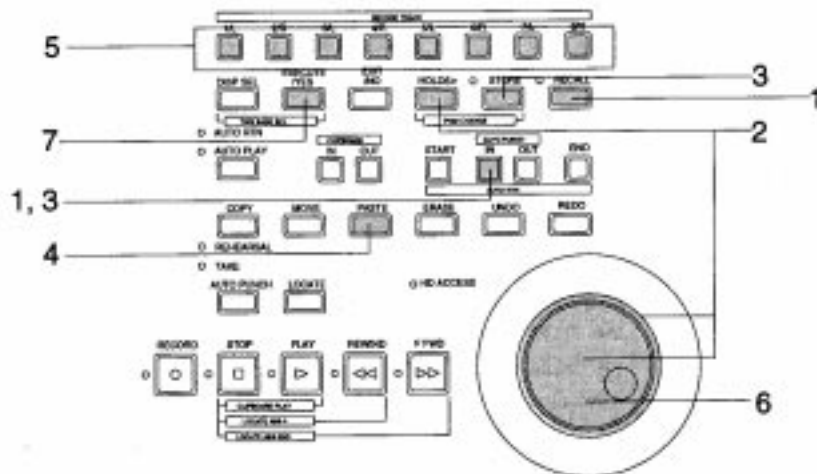

Entering and storing the paste Punch In point

1. Press the **RECALL** key, then the **AUTO PUNCH IN** key (or press only the **AUTO PUNCH IN** key), and the unit enters edit mode.
2. Move the cursor to the digit you wish to edit using the **HOLD/>** key or the **SHUTTLE** dial, and set the value using the **JOG** dial.
3. After setting the time value, press the **STORE** key, then the **AUTO PUNCH IN** key. The time value will be stored as the start point of the pasting area, and the display will go back to the previous screen.

Executing the paste operation

4. Press the **PASTE** key.
The display will show the blinking message "SURE?" and the bottom row of the 7-segment display will show "rPt 01" ("01" will blink) and "MoVE."
5. Specify the Move & Paste destination track and the number of repeats to paste.
 - * **Specifying the Move & Paste destination track:**
Select the destination track using the **RECORD TRACK** select key. (You do not need to specify the track if you are going to Move & Paste data in the copy source track.)
 - * **Specifying the number of repeats to Move & Paste:**
Turn the **JOG** dial to change the blinking number "01" to any value between 01 and 99. (If there is not enough free space on the hard disk, the repeat time will be limited to a number less than 99, and you will be unable to specify a larger number when you turn the **JOG** dial.)
6. Press the **EXECUTE/YES** key.
The upper row of the display will show the time taken for the Move & Paste operation, then "MoVE", "PAsT", then "COMPLETED!". Press the **EXIT/NO** key to go back to the previous screen.

Now the audio data on the Clipboard has been pasted to the specified track starting with the **AUTO PUNCH IN** point.
For example, executing the function with a repeat number of "rPt 03" (three times) will paste the data as shown in the diagram below.

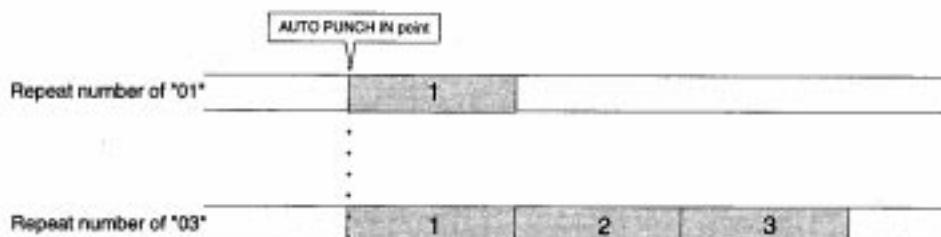

* To cancel the paste operation, press the **EXIT/NO** key while the message "SURE?" is blinking on the display.
If you wish to cancel the paste operation after you press the **EXECUTE/YES** key, press the **STOP** button or the **EXIT/NO** key before the "COMPLETED!" message appears on the display.
If you abort the paste operation using this procedure (even in the middle of the operation), no data will be pasted.

<Note>

The data on the Clipboard will be cleared after the Move & Paste operation is complete. Unlike the Copy & Paste operation, you cannot move and paste the same data repeatedly.

Move & Paste Undo/Redo

If you wish to restore data that existed before you executed the Move & Paste function, press the UNDO key to restore the status obtained before you pasted the data. Pressing the REDO key after pressing the UNDO key will restore the status before the Undo operation (that is, after pasting). The Undo and Redo functions are effective only while the D-80 is stopped.

After the UNDO key or REDO key is pressed, the display will show "COMPLETED!" and return to the previous screen.

<Note>

You can use the undo/redo functions while the DMT-8vL is in stop mode.

Under the following circumstances, you will be unable to use the undo/redo functions:

1. if you make a new recording,
2. if you make a new edit (Copy & Paste, Move & Paste, Erase, or Cut),
3. if the Auto Punch In point was passed in play or record mode while Auto Punch mode was on, or
4. if you turned off the power to the DMT-8vL, then turned it back on.

3. Erase & Cut

The Erase function and Cut function are two different function, and are defined as follows on the DMT-8VL. Make sure that you understand the difference before using these functions.

<Note>

The Cut/Erase function is effective only for the currently-selected Program.

Erase:

This function deletes (creates silence) only a specified area (between the Auto Punch In and Auto Punch Out points) of any track on the hard disk. Refer to the diagram below.

You cannot erase data on all tracks simultaneously. (To erase data, "ready" up to seven tracks using the RECORD TRACK select keys.) Refer to the following note for information on erasing all tracks data.

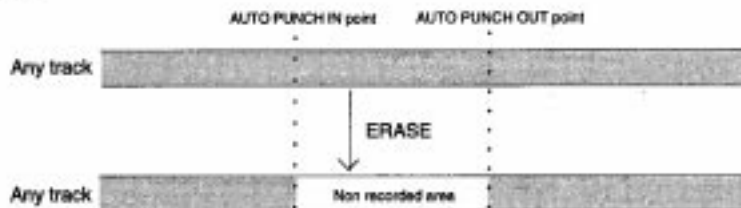

<Note>

The Cut function erases data from all tracks simultaneously (described later). To erase data from all tracks, divide the tracks into two groups and apply the Erase function to each group. (For example, first erase Tracks 1-4, then erase Tracks 5-8.)

Cut:

This function deletes data starting from a certain point (Auto Punch In point) on the hard disk. You need to set all the tracks RECORD TRACK select keys to "READY." Only the start point is needed. Refer to the following diagram:

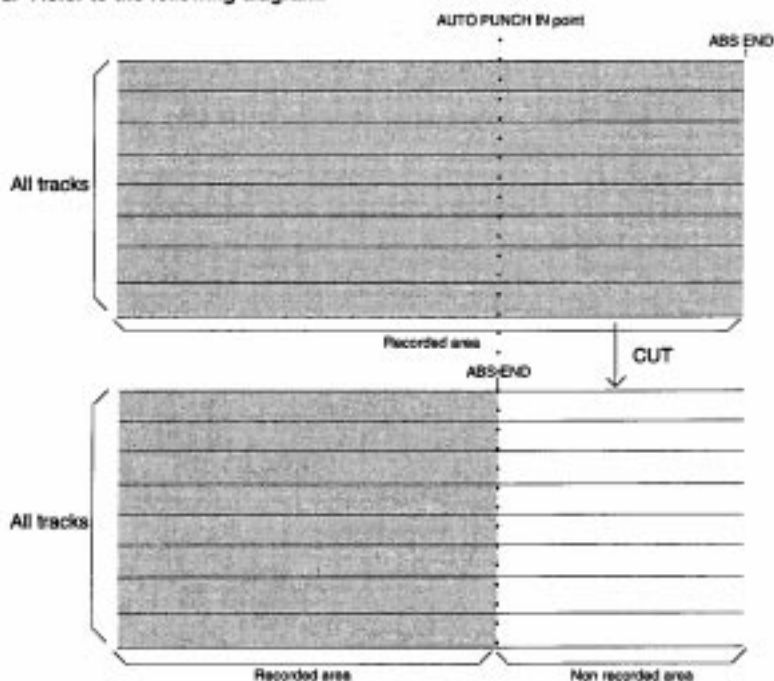

Erasing

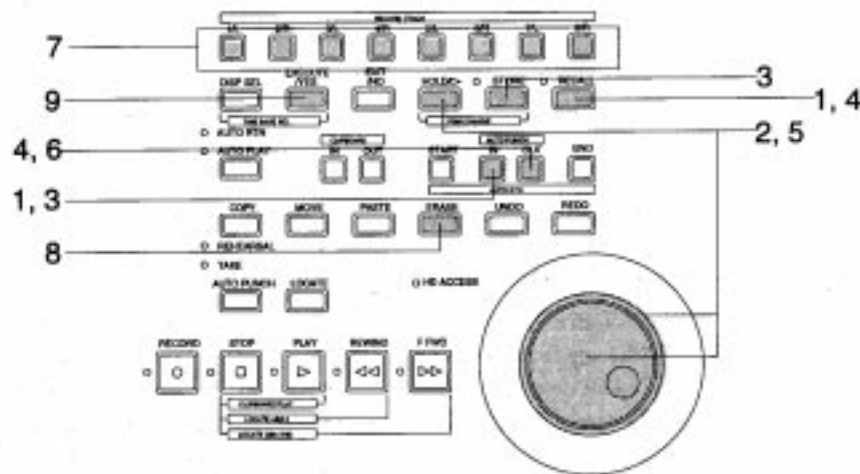

Entering and storing the erase Punch In (start) point

1. Press the **RECALL** key, then the **AUTO PUNCH IN** key (or press only the **AUTO PUNCH IN** key), and the unit enters edit mode.
2. Move the cursor to the digit you wish to edit using the **HOLD/>** key or the **SHUTTLE** dial, and set the value using the **JOG** dial.
3. After setting the time value, press the **STORE** key, then press the **AUTO PUNCH IN** key.
The time value will be stored as a start point of the "pasting area", and the display will return to the previous screen.

Entering and storing the erase Punch Out (end) point

4. Press the **RECALL** key, then the **AUTO PUNCH OUT** key (or press only the **AUTO PUNCH OUT** key), and the unit enters edit mode.
5. Move the cursor to the digit you wish to edit using the **HOLD/>** key or the **SHUTTLE** dial, and set the value using the **JOG** dial.
6. After setting the time value, press the **STORE** key, then the **AUTO PUNCH OUT** key.
The time value will be stored as an end point of the "erasing area," and the display will return to the previous screen.

* To check the erase In/Out point, press the **AUTO PUNCH IN** and **AUTO PUNCH OUT** keys respectively. The display will show the stored time value.

Erasing

7. Press the **RECORD TRACK** select key of the track from which you wish to erase data (to ready the track).

<Note>

Pressing the **RECORD TRACK** select keys to set all tracks in ready status will cut data as described later.

8. Press the ERASE key.

The upper row of the 7-segment display will show "ErAS," and the message "SURE?" will blink.

9. Press the EXECUTE/YES key.

When the operation is completed, the "ErAS" message is lit on the bottom row of the display, and message "COMPLETED!" appears. Press the EXIT/NO key to return to the previous display.

In this way, the sound data of the specified area is erased.

Undo/Redo the Erase operation

If you wish to restore data that existed before you executed the Erase function, press the UNDO key to restore the status of the DMT-8vL before you erased the data. Pressing the REDO key after pressing the UNDO key will restore the status of the DMT-8vL prior to the Undo operation. The Undo and Redo functions are effective only while the DMT-8vL is stopped. After the UNDO key or REDO key is pressed, the display will show "COMPLETED!" and return to the previous screen.

<Note>

You can use the undo/redo functions while the DMT-8vL is in stop mode. Under the following circumstances, you will be unable to use the undo/redo functions:

1. if you make a new recording,
2. if you make a new edit (Copy & Paste, Move & Paste, Erase, or Cut),
3. if the Auto Punch in point was passed in play or record mode while Auto Punch mode was on, or
4. if you turned off the power to the DMT-8vL, then turned it back on.

Cutting

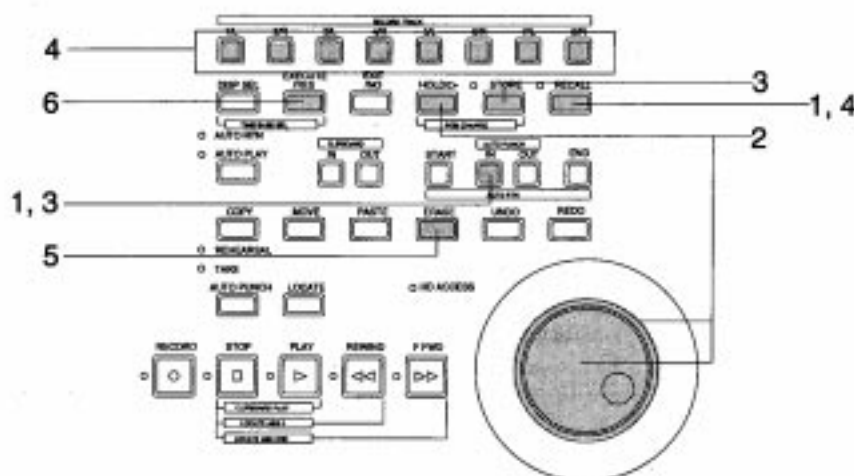

Entering and storing the cut Punch in (start) point

1. Press the RECALL key, then the AUTO PUNCH IN key (or press only the AUTO PUNCH IN key), and the unit enters edit mode.
2. Move the cursor to the digit you wish to edit using the HOLD/> key or the SHUTTLE dial, and set the value using the JOG dial.

3. After setting the time value, press the STORE key, then press the AUTO PUNCH IN key.

The time value will be stored as a start point of the cut area, and the display will return to the previous screen.

* To check the cut in point, press the AUTO PUNCH IN key. The display will show the stored time value.

Executing the cut operation

4. Press all RECORD TRACK select keys (to ready all tracks).

5. Press the ERASE key.

The upper row of the 7-segment display will show "Cut," and message "SURE?" will blink.

6. Press the EXECUTE/YES key.

When the operation is complete, the display shows the message "COMPLETED," then returns to the previous screen.

* In this way, sound data starting from a specified position is cut, and an unwritten area will be left on the hard disk.

Undo/Redo the Cut operation

If you wish to restore data that existed before you executed the Cut function, press the UNDO key to restore the status of the DMT-8vL prior to the cut. Pressing the REDO key after you press the UNDO key will restore the status prior to the Undo operation. The Undo and Redo functions are effective only while the DMT-8vL is stopped. After the UNDO key or REDO key is pressed, the display will show "COMPLETED!" and return to the previous screen.

<Note>

You can use the undo/redo functions while the DMT-8vL is in stop mode.

Under the following circumstances, you will be unable to use the undo/redo functions:

1. if you make a new recording,
2. if you make a new edit (Copy & Paste, Move & Paste, Erase, or Cut),
3. if the Auto Punch In point was passed in play or record mode while Auto Punch mode was on, or
4. if you turned off the power to the DMT-8vL, then turned it back on.

<Note>

If you try to cut the data for a Program in its entirety by storing the ABS 0 point at the Auto Punch In point, about 100ms of data may remain at the beginning.

In this case, use the ERASE function to erase the unnecessary part. (The Erase function can erase data that was not deleted by the Cut function.)

Setup mode

The Setup mode of the DMT-8vL allows you to set various parameters related to the applications and environment. The following items are included in Setup mode. This chapter explains the basics of Setup mode, including how to set the parameters.

○ :Setup for each program ● :Effective against ALL

Indication	Function	Commonness	Default setting
BAR ↵	Sets the time signature on the Tempo Map (selected from 11 signatures: 1/4 - 8/8).	○	001 BAR 04 04
TEMPO	Sets the tempo on the Tempo Map.	○	001 BAR 1. 120
CLiCk	Turns the Metronome function on/off.	○	OFF
LOAD	Loads a data file saved on a DAT to the D-80.	○	
SAVE	Saves recordings/setup data from the hard disk to the DAT machine.	○ (*1)	
FORMAT	Initializes the hard disk.	●	
PREROLL TIME	Sets the preroll value for the locate point.	○	00S
MIDI SYNC OUT	Selects the signal output from the MIDI OUT connector.	○	CLOCK
FRAME RATE	Selects the frame rate for MTC output.	○	25 frame
MTC OFFSET	Sets the offset value between MTC and ABS time.	○	0H 59M 57S 00F 00SF
EnABLE rEc	Selects recording enable/disable.	○	ENABLE
dG in	Selecting a digital input channel.	● (*2)	L -, R -
dG out	Selecting a digital output channel.	● (*2)	ch s, t
rE So Lu ↵	Setting Display Resolution mode ON/OFF.	●	OFF
SLAvE	Setting Slave mode ON/OFF.	○	OFF
dE vi cE	Setting a device ID.	●	00
un do	Setting an effective range of the Undo function.	●	EDIT

*1: Only the currently-selected Program, or all Programs 1-5 will be saved.

*2: The parameters will be set to default when the power is turned off (as well as the locate memory).

*3: You can set the Time Base for each Program individually.

1. Entering Setup mode

Follow the steps below to select a desired Setup mode:

1. Press the DISP SEL key to select Setup mode. (the *SETUP* indicator will blink.)

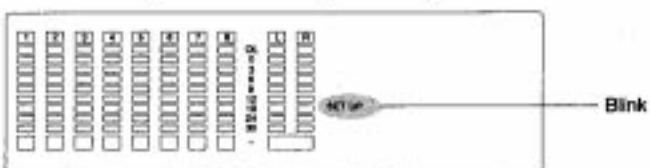

2. Press the EXECUTE/YES key. (The *SETUP* indicator will be lit.)

The display will change as shown below, indicating that the DMT-8vL has entered the first hierarchy.

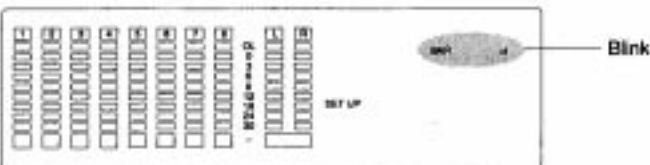

<Note>

When you use the DMT-8vL for the first time, or when you turn on the power to the DMT-8vL after initializing the hard disk, *BAR ↵* will blink on the first stage. Otherwise, the SETUP item last specified will be shown.

3. Turn the JOG dial to show the desired item.

Turning the dial clockwise or counter-clockwise will show each item's title (blinking) on the display.

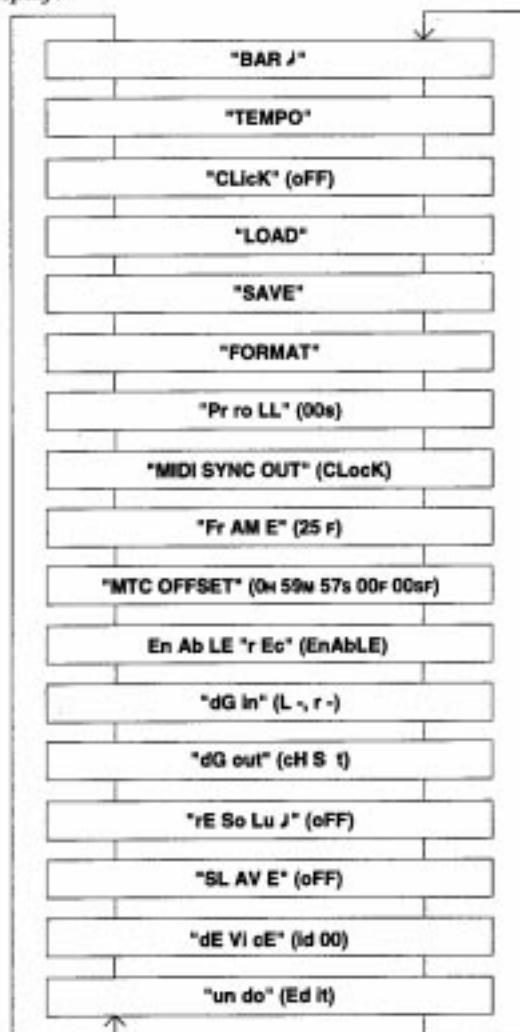

4. After displaying the desired SETUP item, pressing the EXECUTE/YES key again will select each item. (Second stage)

'BAR J' -> Time signature (Default: 1 bar - 4/4)

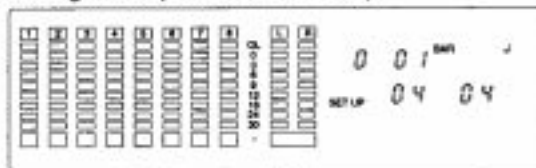

'TEMPO' -> Tempo setting (Default: 1 bar - 1st beat - 120)

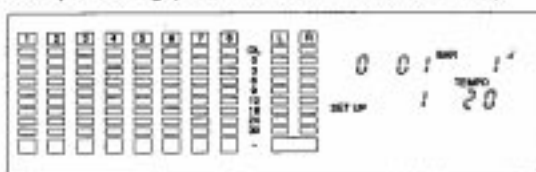

Click->Metronome function (Default: oFF)

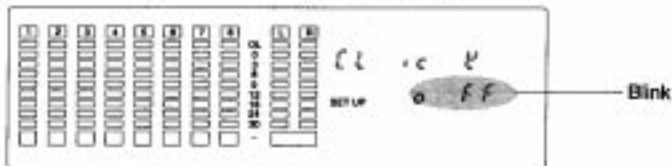

LOAD->Load function (*DIGITAL* is blinking: This indicates that digital signal is not being transmitted correctly from an external DAT to the DMT-8VL.)

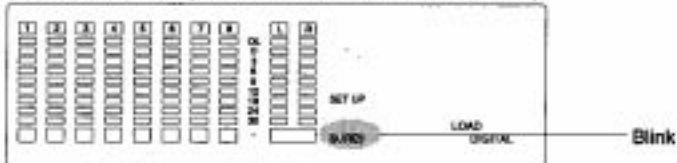

SAVE->Save function

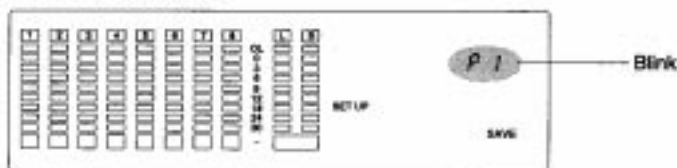

FORMAT->Format function

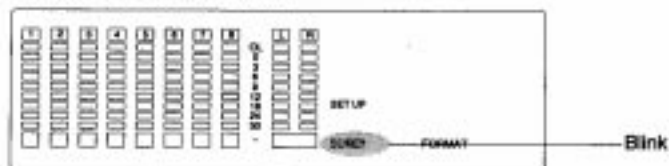

PREROLL TIME->Preroll Time setting (Default: 00s)

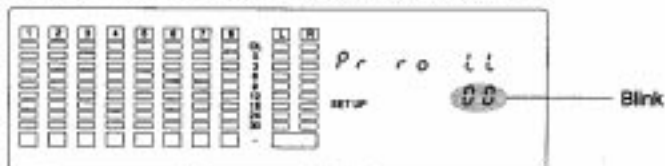

MIDI SYNC OUT->MIDI SYNC OUT setting (Default: Clock signal)

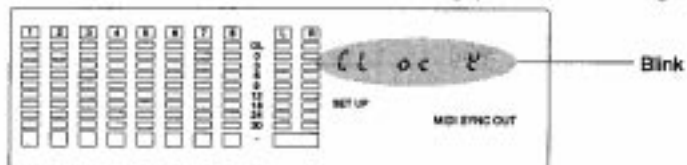

FRAME RATE->MTC Frame Rate setting (Default: 25F)

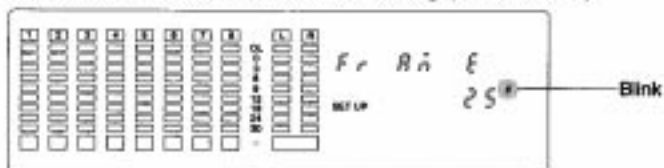

MTC OFFSET->MTC Offset setting (Default: 0_H; 59_M; 57_S; 00_P; 00_{SP})

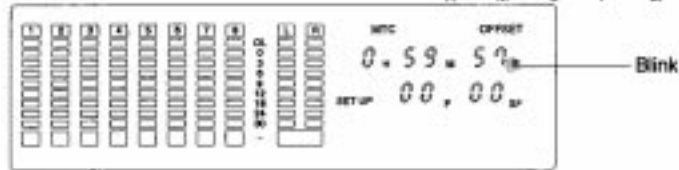

rEc->Recording enable/disable setting (Default: EnABLE)

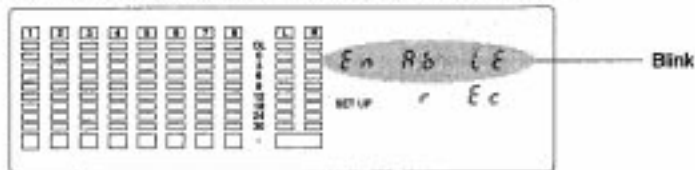

dG in->Selecting a digital input channel (Default: L; -, r; -)

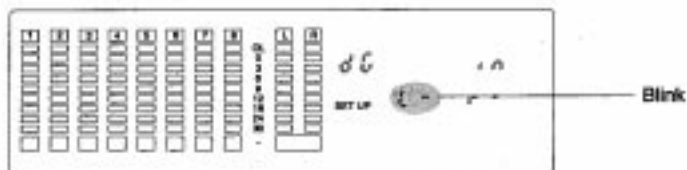

dG out->Selecting a digital output channel (Default: cH St)

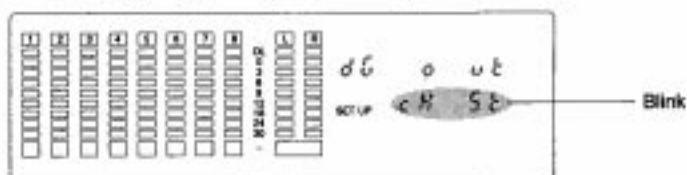

rESoLu->Setting Display Resolution mode ON/OFF (Default: oFF)



SLAvE->Setting Slave mode ON/OFF (Default: oFF)



dEvicE->Setting a device ID (Default: 00)

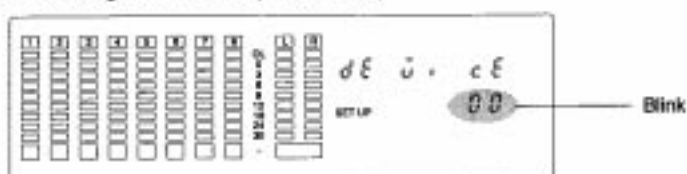

Undo->Setting an effective range of the Undo function (Default: Edit)



- Press the STOP button or the EXIT/NO key to change your selection or to exit Setup mode. Each time you press the STOP button or the EXIT/NO key, the display will return to the previous stage, allowing you to select a different item or to exit Setup mode.

Now you have selected the SETUP items. The following paragraphs explain how to set and execute each item. Refer to the following information on each item for details.

2. Setting the time signature ("BAR J")

Setup item "BAR J" sets a time signature for a measure.

For example, the first and second measures could have a time signature of 4/4, and the third and subsequent measures could have a time of 2/4. You can set up 64 points in any time signature for each measure.

This setting is available for each program, and will be maintained after the power is turned off.

1. Press the DISP SEL key to select "SETUP", then press the EXECUTE/YES key.

(The "SETUP" indicator will light up.)

Use the JOG dial to select "BAR J" (blinking), then press the EXECUTE/YES key. (The "BAR J" indicator will light up.) (In the initial setting, the first measure has a time signature of 4/4. This means that the following measures will be played with a time signature of 4/4 unless you set a different time signature after the first measure.)

In this case, turning the JOG dial will allow you to check the current time signatures one by one.

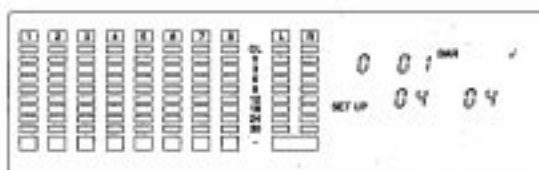

2. Press the EXECUTE/YES key again.

"BAR" on the display will blink, and you will be able to edit the BAR (measure) parameter.

Use the JOG dial to enter a desired measure number, then use the HOLD/> key or the SHUTTLE dial so that "J" is blinking, enabling you to edit a time signature.

Turn the JOG dial to enter a time signature value for the specified measure.

Measures for the "BAR" parameter:	001 - 999
Time signature for the "J" parameter:	1/4, 2/4, 3/4, 4/4, 5/4, 1/8, 3/8, 5/8, 6/8, 7/8, 8/8, --, *
* "--" means "none" and is used to delete time signature data.	

3. Each time you enter bar and time signatures, press the EXECUTE/YES key to store the setting.

Repeat this step to set the necessary time signature for the bar.

- * You cannot assign "--" to measure 001.
- * To cancel edit or quit Setup mode, press the STOP button or the EXIT/NO key. Pressing the STOP button or the EXIT/NO key repeatedly will step back through the previous settings, then quit Setup mode.

Follow the procedure below to modify (delete) a stored time signature

1. While the "BAR" indicator is blinking, turn the JOG dial to enter the number of the measure you wish to modify.

The measure number and time signature you set will be displayed.

2. Use the HOLD/> key or the SHUTTLE dial to move the cursor to the blinking "J" field.

3. Use the JOG dial to enter a new time signature value.

Assigning "--" deletes the stored value.

4. After modifying the value, press the EXECUTE/YES key.

- * If the bar/beat position of the tempo data (stored by the tempo setting procedure explained later) is lost when you modify or delete the stored beat data, the tempo data will be automatically erased for ever. (For example, if you change the time signature to 3/4 for BAR 001, the existing tempo data at BAR 001 4 J will be automatically deleted.)

* To cancel a selection or quit Setup mode, press the STOP button or the EXIT/NO key. Pressing the STOP button or the EXIT/NO key repeatedly will step you back through the previous settings, then quit Setup mode.

Follow the procedure below to clear all stored beat/tempo data

1. While "BAR" is blinking, turn the JOG dial counter-clockwise.

The information on the first measure will appear, followed by subsequent information. The beat data and the tempo data (explained later) will be ready for the all-clear operation.

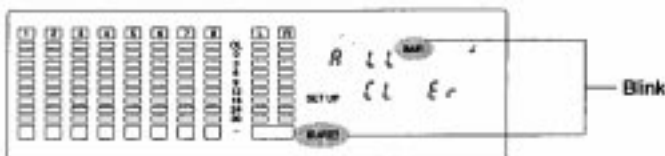

2. Press the EXECUTE/YES key.

All stored time signature and tempo data will be cleared, and the default setting will be restored.

* If you do not want to clear all of the time signature and tempo data, press the STOP button or the EXIT/NO key.

<Note>

If you attempt to enter time signature and tempo data in a position that exceeds the maximum recording time, the value will be not effective.

3. Tempo setting ("TEMPO")

The Setup "TEMPO" allows you to set the tempo on the tempo map. You can set up to 64 points in the range of quarter note = 30 to 250 at any position in the song (if it has been structured by the beat settings). For example, you can set a specific tempo value on a specific beat in the certain measure. The setting sequence is "BAR" -> "J" -> "TEMPO."

1. Press the STORE key while pressing and holding down the HOLD/> key to select a Program.

2. Press the DISP SEL key to select "SETUP" and press the EXECUTE/YES key.

("SETUP" will light up.)

Then, use the JOG dial to select "TEMPO" (blinking) and press the EXECUTE/YES key. ("TEMPO" will light up.) At this time, turning the JOG dial allows you to check the current tempo settings one by one. (The default value for the first beat of the first measure, the tempo will continue to be J = 120.)

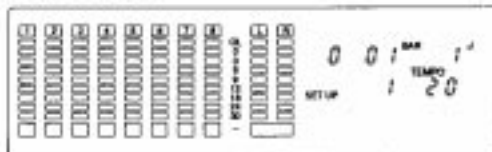

3. Press the EXECUTE/YES key again.

"BAR" on the display will blink, indicating that "BAR" (measure) can be edited now. Use the HOLD/> key or SHUTTLE dial to select a desirable editing item ("BAR", "J", or "TEMPO"), modify the value using the JOG dial, and press the EXECUTE/YES key.

- * Bar and beat values for "BAR J" -> The range of the bar and beat specified by the time signature settings.
- * Values for "TEMPO" -> 30 to 250, and -- ("--" indicates "none" and is used to delete tempo data.)
- * You cannot store "--" in the position of 001BAR 1.

<Example>

After setting the time signature as follows, set a desired tempo.

The image shows two musical staves. The first staff is in 4/4 time and contains a sequence of eighth notes. Below the first measure, an arrow points to the text "TEMPO=120". Below the fifth measure, an arrow points to the text "TEMPO=90". The second staff is in 3/4 time and contains a sequence of eighth notes. Below the first measure, an arrow points to the text "TEMPO=60". Below the fifth measure, an arrow points to the text "TEMPO=120".

TEMPO MAP	
Time Signature	TEMPO
001 ^{BAR} 0404	001 ^{BAR} 1 ^{BEAT} 120 ^{TEMPO} 003 ^{BAR} 1 ^{BEAT} 90 ^{TEMPO}
005 ^{BAR} 0304	005 ^{BAR} 3 ^{BEAT} 60 ^{TEMPO} 007 ^{BAR} 2 ^{BEAT} 120 ^{TEMPO}

Follow the procedure below to modify or delete stored tempo data

1. While "BAR" is blinking, turn the JOG dial to recall the measure in which the tempo data to be modified is stored.
2. While "J" is blinking (move the cursor here using the HOLD/> key or the SHUTTLE dial), use the JOG dial to recall the beat at which the tempo data to be modified is stored.

The display will show the current tempo data setting.

3. While "TEMPO" is blinking, enter a new tempo value using the JOG dial.
If you select "--" (located between 30 and 250), stored data will be deleted.
4. When you finish modifying the value, press the EXECUTE/YES key.

- * If you wish to cancel the procedure or quit Setup mode, press the STOP button or the EXIT/NO key. Pressing the STOP button or the EXIT/NO key repeatedly will take you to the step just before you quit Setup mode.

Follow the procedure below to clear all stored tempo data

Refer to "2 Setting the Time Signature" to clear all tempo data along with the time signature data. So far, the time signature and tempo have been set on the tempo map.

The tempo map information will be output as the MIDI clock and Song Position Pointer information to an external sequencer via the DMT-8vL MIDI OUT connector. (Refer to page "67" for details about the MIDI clock sync system.)

In addition, using the metronome function on the DMT-8vL allows you to play back the tempo map data on track 8 using the click sound. Refer to the following section for information on the metronome function.

<Note>

The DMT-8vL will play back only recorded data from the disk.

If nothing has been recorded, no tempo map information will be output from the MIDI OUT connector.

5. Saving and loading the recordings ("SAVE", "LOAD")

You can select whether you wish to save the "currently-selected" single Program (audio data plus Setup data) or "all" Programs to the connected DAT machine. This function allows you to store finished or incomplete songs to the DAT machine temporarily, and is useful when you wish to create more recording space. Since the save/load operation for each Program is executed as illustrated in the diagram below, the process duration will be four times the total length of all Program data (time length up to ABS END).

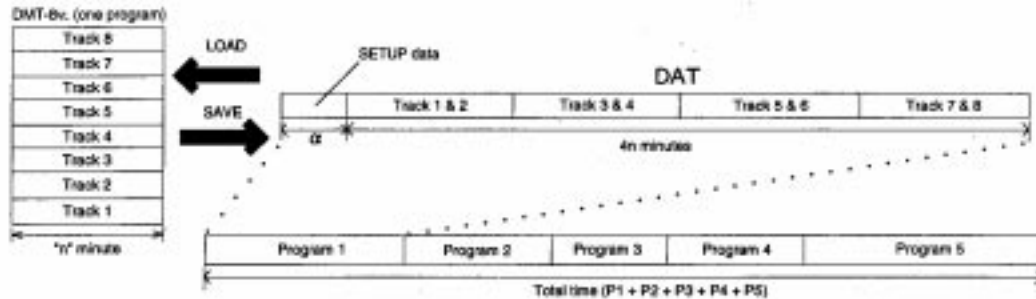

If you save all Programs, the process duration will be four times the total length of all Program data to save them. The following diagram shows the sequence of the Programs saved to the DAT machine:

P1 -> (10 seconds between the songs) -> P2 (10 seconds between the songs) -> P3 (10 seconds between the songs) -> P4 (10 seconds between the songs) -> P5.

Data output pattern when "SAVE ALL (saving all Programs 1-5)" is selected:

Gray: Setup data (You will hear the beep.)
 Black: Audio data (You will hear the audio data.)
 White: Non data (Non recorded area.)

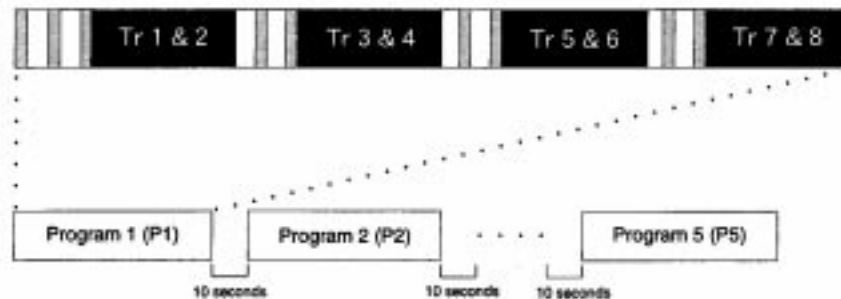

<CAUTION>

You can save all Programs 1-5 at once, but you cannot load them back to the DMT-8VL at once. (You can load Programs one by one.) For details, refer to the "Loading from the DAT Machine (LOAD)" for details.

Connecting a DAT machine to save/load data

- Use optical cables to connect the DMT-8vL DATA IN connector with the DAT OPTICAL OUT connector, and the DMT-8vL DATA OUT connector with the DAT OPTICAL IN connector.
- Insert a DAT recording tape in the DAT machine.
- Set the DAT machine so that it will record digital data input from the optical connector. For more information on DAT settings, refer to the instruction manual that came with your DAT machine.

<Note>

To save and load data, you can use only a DAT machine that allows for digital recording with 16 bit/44.1kHz, non-compression recording, optical, S/P DIF format. Other media cannot be used appropriately for save/load operations. For example, you cannot use an MD or DCC that uses a compression recording method, a CD-R machine that makes an automatic correction between songs, any devices that convert sampling rates, or any devices that have Adat optical connectors. Some devices equipped with SCMS can be used if they satisfy the conditions described above.

The following models can correctly save/load data. Basically, any DAT machines equipped with optical in/out connectors in the S/P DIF format should work fine. However, please note that some models may cause errors to occur.

FOSTEX: D-10, D-5 SONY: TCD-D7, DTC-790 PIONEER: D-05

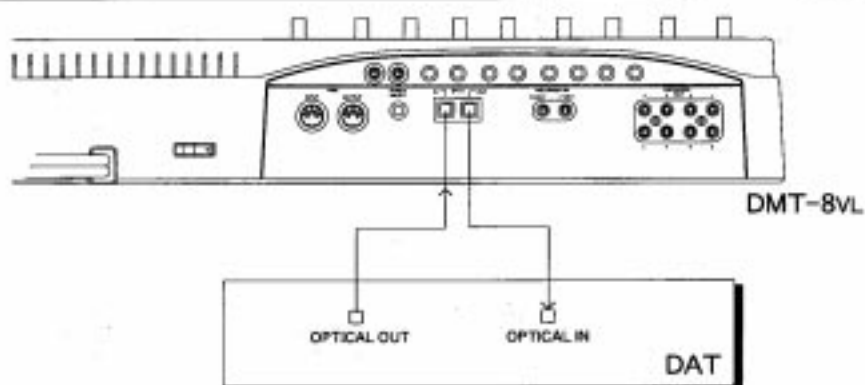

<Note>

When you are loading data from a DAT connected to the DMT-8vL, and if that DAT plays back data in sync with an external clock (e.g., if it is a professional level DAT machine) with its INPUT (or EXTERNAL SYNC) switch set to "OPTICAL," the digital clock will form loops as shown below, preventing the DMT-8vL from loading data correctly.

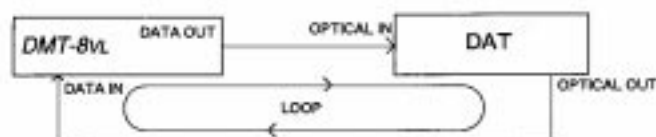

In this case, set the DAT sync mode to "INTERNAL" or remove the optical cable from the DMT-8vL DATA OUT connector. (On the other hand, while data is saved, its DATA IN will not function. Thus, no problem will occur.)



Saving data to a DAT machine (SAVE)

1. Press the STORE key while pressing and holding down the HOLD/> key to select a Program.
2. Press the DISP SEL key to select "SETUP" and press the EXECUTE/YES key. ("SETUP" will light up.)

Turn the JOG dial to select "SAVE" (blinking) and press the EXECUTE/YES key.

The display will change as shown below, and the Program number currently selected ("P1" in this example) will blink. At this time, you can select whether you wish to save only this Program, or to save all Programs. Turn the JOG dial clockwise to select "ALL" or counter-clockwise to select "P1."

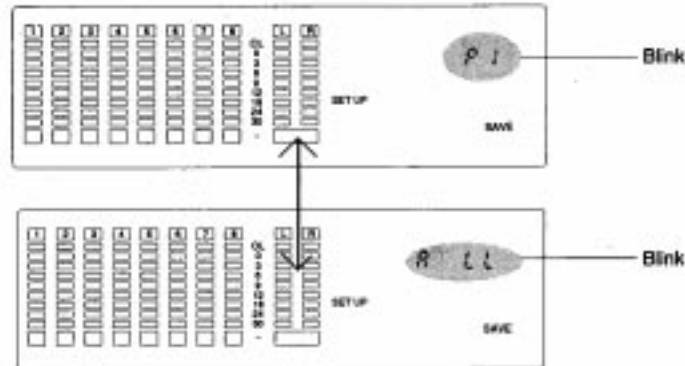

3. Press the EXECUTE/YES key again.

The display will change to something like this, and the DMT-8vL will enter Save Standby mode.

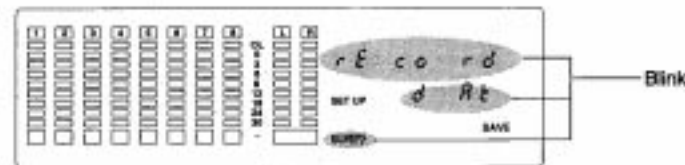

4. Start recording on the DAT machine.

At this time, recording the DAT START ID is useful when you wish to locate a data point.

5. After confirming that the DAT is in the recording mode, press the EXECUTE/YES key again.

The Save operation will start, and the display will count down the time (a negative number appears) required for the save operation.

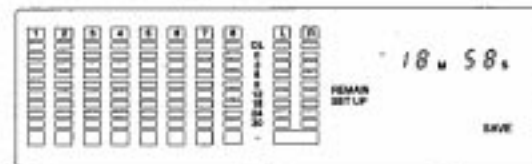

When saving all data is finished, the display will show "COMPLETED!" and the unit will automatically quit Setup mode.

- * To cancel the save operation or quit Setup mode, press the STOP button or the EXIT/NO key. Each time you press the STOP button or the EXIT/NO key, the display will return to the previous stage, allowing you to select a different item or exit Setup mode.
- * Refer to the earlier explanation for more information on the save operation and its process duration.

<Hint>

• **Loading data that was partially saved**

You can stop the save operation in mid-process, and load the saved data from the DAT machine to the DMT-8vL.

This feature is useful when you wish to save or load, for example, only the data from Tracks 1-4. In this case, you can save the time and cut recording space by half.

However, please note the following:

1. You can load data that was saved before you stopped the save operation.

<Example>

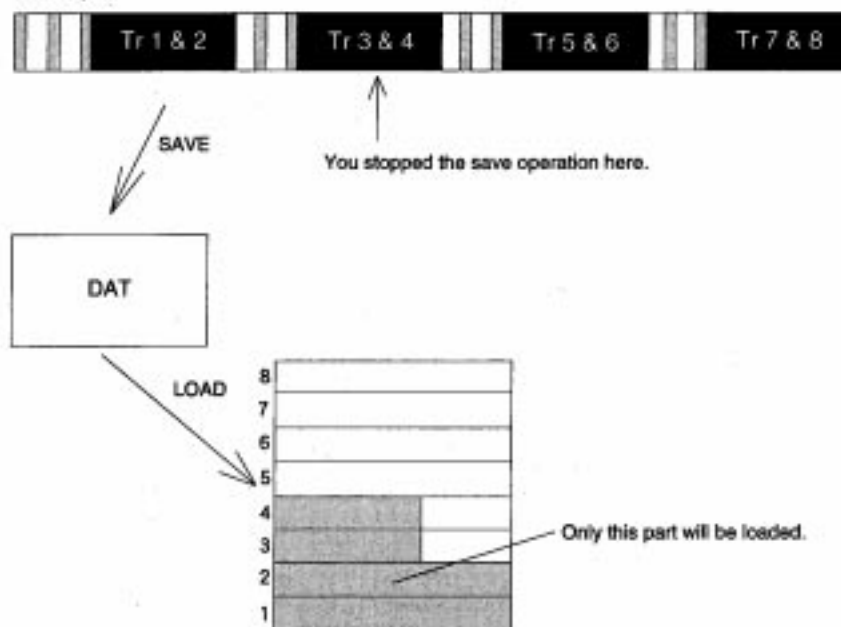

2. If you stop the save operation in the setting data area (gray area in the figure), an error may occur and you may not be able to load the data. Be sure to stop the save operation at a point when you are not hearing a beep after the audio on Tracks 1 and 2 has already started.
3. The loading time shown on the display at the beginning of the loading operation will match the saving time that was shown on the display when you saved the data. Press the EXIT/NO key (or the STOP button) at an appropriate time during loading (for example, in the middle of Tracks 3 and 4 in the example above) to stop loading.

The data sent to the DMT-8vL before you stopped loading will be loaded to each track. In this case, the display will not show "COMPLETED." (If you stop loading in the mid-process on Tracks 1 and 2, the time value at the time of stop will become "ABS END.")

As mentioned in paragraph 2 above, do not stop loading in the setting data area (gray area).

4. When you start loading data from a DAT machine, the existing songs will be lost. That is, even if you stop loading in mid-process, the newly loaded data will replace all existing program data. For example, assume that you already have a six-minute song on the DMT-8vL. If you load a two-minute song, the data after two minutes will be lost. (ABS END will be "two minutes.") Before you perform the load operation, make sure that you have selected an appropriate program number.

Loading data from a DAT machine (LOAD)

<Note>

You can save Programs 1-5 simultaneously, but you cannot load them back to the DMT-8vL simultaneously. (You can load Programs one by one.) To load data, first select the Program number, then send the data of the song from the DAT. (Only one song can be loaded into each Program.)

1. Press the STORE key while pressing and holding down the HOLD/> key to select a Program.
2. Locate a position a little before the beginning of data on the DAT tape (pre-rol).
If the data begins from the top of the tape, rewind the tape all the way.
3. Press the DISP SEL key to select "SETUP" and press the EXECUTE/YES key.
("SETUP" will light up.)
*Turn the JOG dial to select "LOAD" (blinking) and press the EXECUTE/YES key.
The display changes as shown below, and the DMT-8vL enters load stand-by mode.*

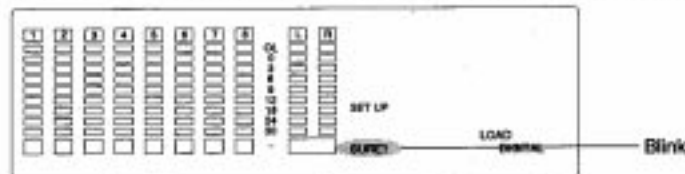

<Note>

If optical cables are not connected to the DATA IN/OUT connectors, or if a correct signal (digital clock) is not being supplied to the DMT-8vL, "DIGITAL" on the display will blink, indicating that you are unable to load data. In this case, check the optical cable connections, the DAT output settings, and the contents of the DAT tape.

4. Press the EXECUTE/YES key again.
"PLAY dAt" starts blinking on the display as shown below. (This means "Start playback on the DAT machine.")

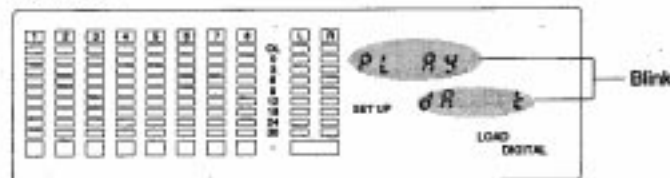

<Note>

Do not connect or disconnect the optical cable during the load stand-by status. Otherwise, DMT-8vL may generate noise, affecting the external devices.

5. Start playback the DAT machine.

As soon as the loading operation starts, the display will show the time taken for the load operation, then count down. The data will be loaded to the currently-selected Program.

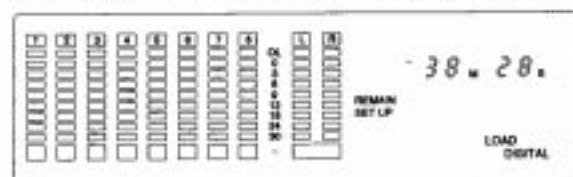

* To cancel the load operation, press the STOP button or the EXIT/NO key. Pressing this key will cancel the load operation, and the unit will quit Setup mode.

When loading all data is finished, the display will show "COMPLETED !" and the unit will automatically quit Setup mode.

<CAUTION>

Once the loading operation starts, aborting the operation in progress will erase all existing data in the Program, and data up until the moment of that abort will be loaded.

For example, if you have loaded two minutes of data into Program 1 (P1), which already holds a six-minute song, the existing data after two minutes will be erased. (The ABS END position of P1 is "two minutes.")

Make sure that you have selected the correct Program number before using the Load function.

Refer to the diagram below if you are loading Program 3 data from the DAT into Program 1.

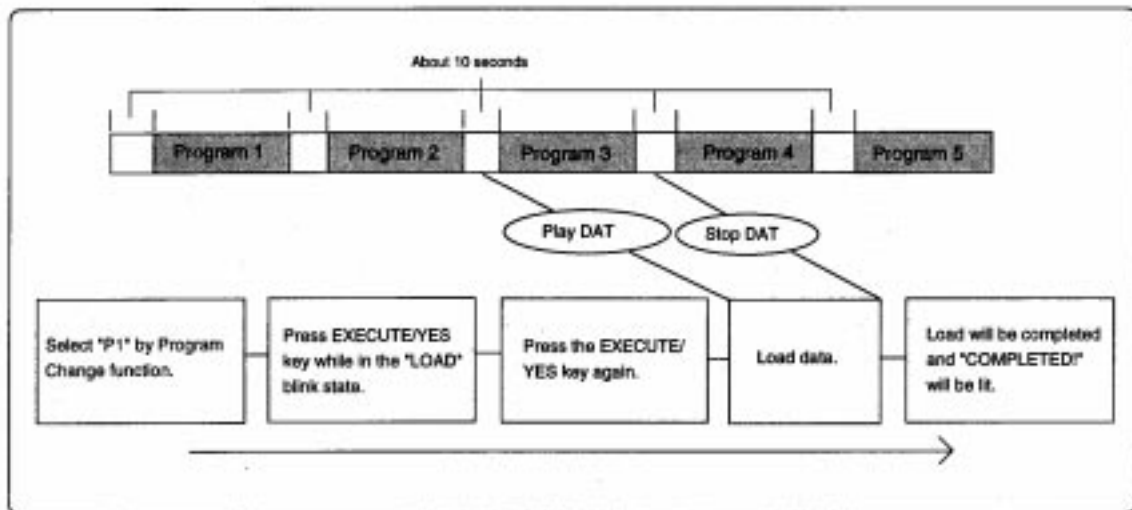

<Note on loading data>

You cannot load data from a connected DAT machine if "rEc EnAbLE/dISAbLE" of SETUP mode is set to "dISAbLE."

Make sure that "rEc EnAbLE/dISAbLE" of SETUP mode is set to "EnAbLE" before loading data.

Refer to page "128" for more information on "rEc EnAbLE/dISAbLE" in SETUP mode.

6. Formatting the hard disk ("FORMAT")

Setup "FORMAT" allows you to format (initialize) the hard disk. When you format the disk, all the existing recordings and other data, as well as the Setup data, will be initialized to factory default settings.

* Refer to page "41" for more information on replacing the hard disk.

1. Press the DISP SEL key to select "SETUP" and press the EXECUTE/YES key.

("SETUP" will light up.)

Turn the JOG dial to select "FORMAT" (blinking) and press the EXECUTE/YES key. The display changes as shown below, and the DMT-8vL enters format stand-by mode.

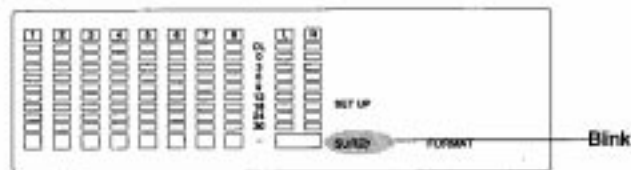

* To cancel the format operation, press the STOP button or the EXIT/NO key.

<Note>

Once you start formatting the disk, you cannot cancel the operation once it is underway. (Even the STOP button and the EXIT/NO key are disabled.) If you do not wish to lose the recorded audio data, do not press the EXECUTE/YES key at this time.

2. Press the EXECUTE/YES key again.

The Format operation will start, and the display will show the available recording time (not the time taken for formatting), and count down the time.

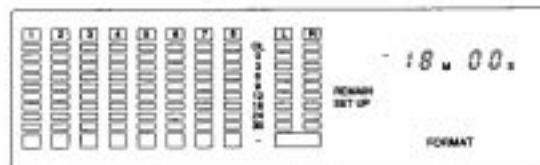

3. When formatting is complete, the display will change as shown below.

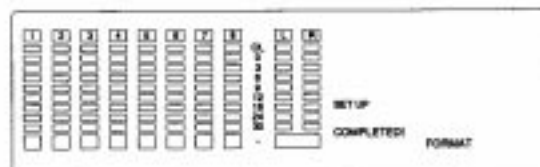

4. Pressing the STOP button or the EXIT/NO key will allow you to quit Setup mode, and the DMT-8vL will stop at the position (timebase = ABS 00M 00S 00F) obtained right after you turned on the power to the DMT-8vL for the first time.

7. Setting the preroll time for the Locate operation ("PREROLL TIME")

The DMT-8vL is equipped with a preroll function that parks the DMT-8vL a specified time before the locate point when you perform the locate operation.

You can set any preroll time between 0-10 seconds using the Setup "PREROLL TIME" parameter. This function is useful when you wish to start monitoring data slightly before the stored locate point.

This setting is available for each Program, and will be maintained after the power is turned off.

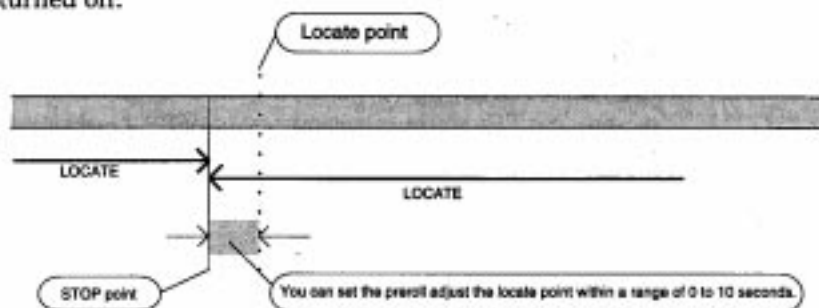

1. Press the STORE key while pressing and holding down the HOLD/> key to select a Program.
2. Press the DISP SEL key to select "SETUP" and press the EXECUTE/YES key. ("SETUP" will light up.)

Turn the JOG dial to select "PREROLL TIME" (blinking), and press the EXECUTE/YES key. The display will change as shown below, and will show the default value. (The default setting is 00 second.)

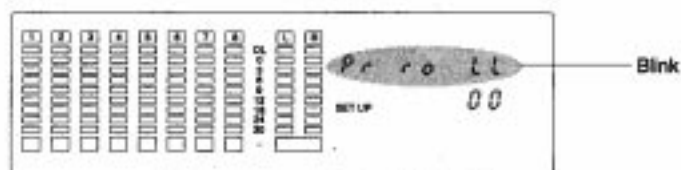

3. Press the EXECUTE/YES key again. ("PREROLL" will light up.)
"S" on the display will blink, indicating that you can edit the value.

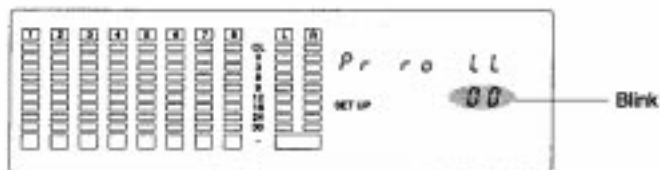

4. Use the JOG dial to enter a desirable preroll time.
Turning the dial clockwise will increment the value, and turning it counter-clockwise will decrement the value.
5. After setting the value, press the EXECUTE/YES key again.
The display will go back to that obtained in step 2, and the setting will be complete.
6. Press the STOP key or EXIT/NO key to quit Setup mode.

8. Selecting the synchronized signal output from the MIDI OUT connector ("MIDI SYNC OUT")

Setup "MIDI SYNC OUT" allows you to select the sync signal output from the DMT-8VL MIDI OUT connector to the external MIDI device.

Output signals can be MIDI Clock & Song Position Pointer, or "Mtc" (MIDI timecode). Select "Clock signal," "Mtc," or "None" according to your application.

This setting is available for each Program, and will be maintained after the power is turned off.

1. Press the STORE key while pressing and holding down the HOLD/> key to select a Program.

2. Press the DISP SEL key to select "SETUP" and press the EXECUTE/YES key. ("SETUP" will light up.)

Turn the JOG dial to select "MIDI SYNC OUT" (blinking), and the display will change as shown below and show the default setting. (The default setting is "Clock.")

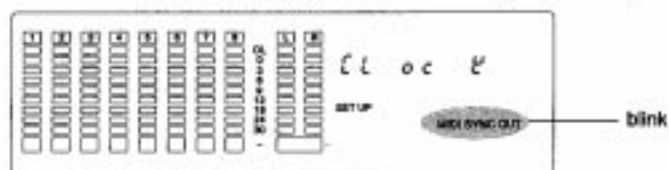

3. Press the EXECUTE/YES key again.

"Clock" on the display will blink, indicating that you can edit the parameter.

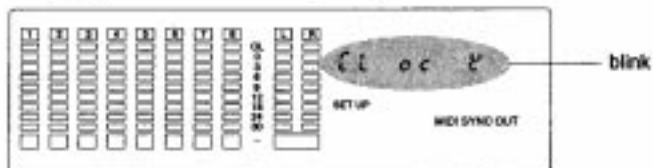

4. Select a desirable option using the JOG dial.

CLock	MIDI Clock signal and song position pointer is output.
Mtc	MIDI timecode is output.
oFF	No signal is output.

5. After selection, press the EXECUTE/YES key again.

The display will return to that displayed in step 2, and the setting will be complete.

6. Press the STOP button or the EXIT/NO key to quit Setup mode.

* See pages "67" and "69" for more information on using a DMT-8VL connected to a MIDI sequencer or computer.

9. Setting the MTC Frame Rate ("FRAME RATE")

"FRAME RATE" in Setup mode allows you to set the MTC frame rate when you select "MTC" for the "MIDI SYNC OUT" parameter to output MIDI timecode to an external computer. You can select 25F, 24F, 30DF, or 30ND for a frame rate. This setting is available for each Program, and will be maintained after the power is turned off.

1. Press the STORE key while pressing and holding down the HOLD/> key to select a Program.
2. Press the DISP SEL key to select "SETUP" and press the EXECUTE/YES key. ("SETUP" will light up.)

Turn the JOG dial to select "FRAME RATE" (blinking), and the display will change as shown below and will display the default setting. (The default setting is "25F.")

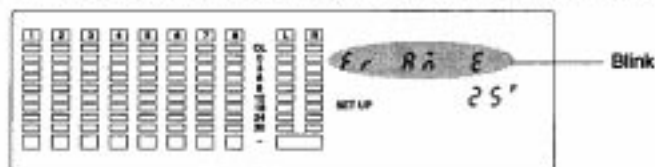

3. Press the EXECUTE/YES key again.

"F" on the display will blink, indicating that you can edit the parameter.



4. Select a desirable option using the JOG dial.

25	25 frames
24	24 frames
dF 30	30 drop frames
nd 30	30 non-drop frames

5. After you select a frame rate, press the EXECUTE/YES key again. The display will return to that displayed in step 2, and the setting will be complete.
6. Press the STOP button or the EXIT/NO key to quit Setup mode.

* See pages *67* and *69* for more information on using a DMT-8vL connected to a MIDI sequencer or computer.

10. Setting MTC Offset Time ("MTC OFFSET")

"MTC OFFSET" in Setup mode allows you to create a time offset from ABS time when you select "MTC" for the "MIDI SYNC OUT" parameter to output MIDI timecode to an external computer. You can specify any time within a range of $0_{hr}:00_{m}:00_{s}:00_{sf} - 59_{hr}:59_{m}:59_{s}:29_{sf}$.

This setting is available for each Program, and will be maintained after the power is turned off.

1. Press the STORE key while pressing and holding down the HOLD/> key to select a Program.

2. Press the DISP SEL key to select "SETUP" and press the EXECUTE/YES key.

("SETUP" will light up.)

Turn the JOG dial to select "MTC OFFSET" (blinking), and the display will change as shown below and will display the default setting. (The default setting is "0:59:57:00.")



3. Press the EXECUTE/YES key again.

"S" on the display will blink, indicating that you can edit the parameter.

Use the HOLD/> key or the SHUTTLE dial to select the digit you wish to edit (hour, minute, second, frame, sub-frame), and use the JOG dial to set or change the value.

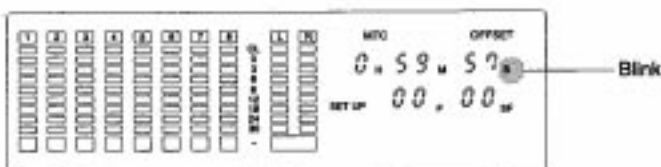

4. After setting the value, press the EXECUTE/YES key again.

The display will return to that displayed in step 2, and the setting will be complete.

5. Press the STOP button or the EXIT/NO key to quit Setup mode.

11. Setting Recording Enable/Disable mode ("rEc" ENABLE/DISABLE)

"REC ENABLE" in Setup mode is used to turn on/off recording enable/disable mode to prevent accidental recording. (This function is similar to breaking the tab on a cassette tape to protect a recording.)

This setting is available for each Program, and will be maintained after the power is turned off.

<Note>

If you select record disable mode (rEc DISABLE), and you try to record, paste, erase, or cut data on any selected track, the display will show "dISAbI rEc" for about one second, indicating that these operations are disabled. If you wish to use one of these operations, first select record enable mode (rEc ENABLE).

1. Press the STORE key while pressing and holding down the HOLD/> key to select a Program.

2. Press the DISP SEL key to select "SETUP" and press the EXECUTE/YES key. ("SETUP" will light up.)

Turn the JOG dial to select "ENABLE REC" (blinking), and the display will change as shown below and will display the default setting. (The default setting is "ENABLE.")



3. Press the EXECUTE/YES key again.

"ENABLE" on the display will blink, indicating that you can edit the parameter.

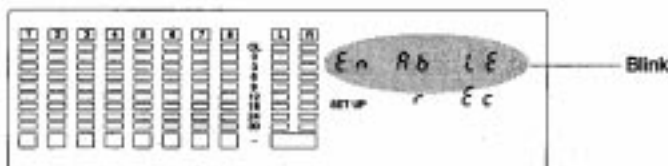

4. Turn the JOG dial clockwise to select "REC DISABLE," or turn it counter-clockwise to select "REC ENABLE."

5. After setting the value, press the EXECUTE/YES key again.

The display will return to that displayed in step 2, and the setting will be complete.

6. Press the STOP button or the EXIT/NO key to quit Setup mode.

12. Setting a digital input channel ("dG in")

Using "dG in" of Setup menu, you can assign any of the analog inputs 1-8 to digital inputs L and R. This assignment will allow you to record digital data from an external digital device (such as CD, MD, etc.) to the DMT-8VL through DATA IN. (You can record data digitally directly to the hard disk, without using an A/D converter.) This setting will be shared by all Programs. Turning the power off will set this setting to "OFF."

<WARNING>

You cannot use the tracks for analog recording if they are assigned to digital input. Therefore, return this parameter to the "OFF" setting after digital recording is complete.

1. Press the DISP SEL key to select "SETUP" and press the EXECUTE/YES key.

("SETUP" will light up.)

Turn the JOG dial to select the blinking "dG in". The display will change to something like this, and the current value will appear. (The default setting is "L-, r-", indicating that both are off.)

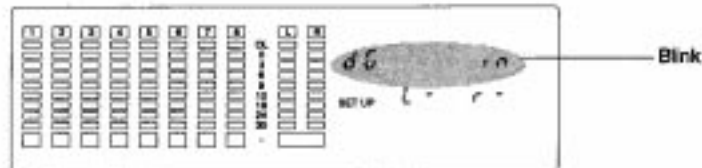

2. Press the EXECUTE/YES key again.

Letter "L-" on the display will blink, and you can now edit the value.

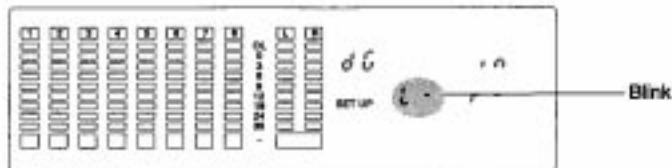

3. Use the SHUTTLE dial (or HOLD/> key) to select blinking "L-" or "r-", and turn the JOG dial to input numeric data (1-8).

<Note>

If you assign the same track to both digital inputs L and R, the L channel will have priority and the R channel will automatically be "OFF."

4. Press the EXECUTE/YES key again.

The display in Step 1 will appear, and the setting is complete.

<Note>

Do not connect or disconnect the optical cable to or from the DATA IN connector while the digital input is routed to any track. Otherwise, the DMT-8VL may generate noise, affecting the external device.

5. Press the STOP button or the EXIT/NO key to quit Setup mode.

<Note>

It is prohibited by law to record and use any piece of music for which copyright is possessed by a third party for commercial purposes - such as concerts, broadcasting, and sales - any purpose other than for your personal pleasure.

<Note>

You cannot record analog signals to those tracks to which the digital inputs are routed. When you finish recording digital data, be sure to set the assignment to " - " (no assignment).

You can route analog signals from the mixer inputs (or RECORDER IN connector) to any track that is not assigned as digital input L or R.

<Note>

The digital output will be muted if any one of the tracks is set to "DIGITAL IN." At this time, the L/R level meters will not respond.

13. Setting a digital output channel ("dG out")

Using "dG out" of Setup menu, you can assign any of analog outputs 1-8 to digital output L or R. Select any one combination from "1-2", "3-4", "5-6", "7-8", "S-t" (stereo output L, R in the mixer section).

This assignment will allow you to record digital data from the DMT-8vL's DATA OUT to an external digital device (such as DAT, MD, etc.)

This setting will be shared by all Programs.

The default setting is "S-t". Turning the power off will set this setting to default.

1. Press the DISP SEL key to select "SETUP" and press the EXECUTE/YES key.

("SETUP" will light up.)

Turn the JOG dial to select blinking "dG out".

The display will change to something like this, and the current value will appear.

(The default setting is "cH S-t".)

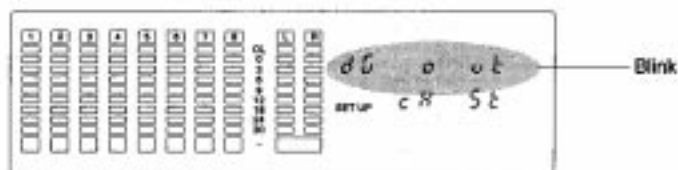

2. Press the EXECUTE/YES key again.

The letter "cH S-t" on the display will blink, and you can now edit the value.

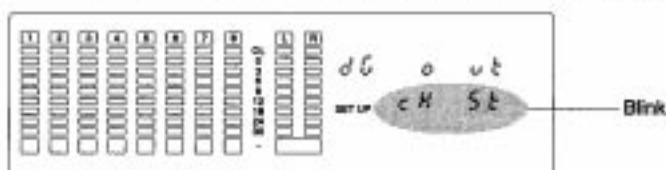

3. Use the JOG dial to select from "1-2", "3-4", "5-6", "7-8", "S-t".

4. Press the EXECUTE/YES key again.

The display in Step 1 will appear, and the setting is complete.

5. Press the STOP button or the EXIT/NO key to quit Setup mode.

<Note>

The digital output will be muted in the following situations. At this time, the L/R level meters will not respond.

1. When the DMT-8vL is in LOAD mode, or
2. When any one of the tracks is set to "DIGITAL IN."

14. Setting Display Resolution mode On/Off ("rESoLu")

"rESoLu" in Setup menu allows you to turn Display Resolution mode on and off. When you are storing the In/Out points in real-time while using the "BAR/BEAT/CLK" Time Base, you can store them in steps of beats if the "rESoLu" (Display Resolution mode On/Off) in Setup mode is "ON".

When this resolution mode is "ON", the CLK value will be rounded up or off to "00" (at the beginning of the beat) as soon as you press the STORE key. This function is useful when you wish to use the Copy & Paste or Move & Paste function in steps of beats.

This setting will be shared by all Programs and maintained after you turn off the power.

* For example, if you try to store value "001^{BAR}, "1^{BEAT}, "46^{CLK} as the copy start point, and "002^{BAR}, "4^{BEAT}, "51^{CLK} as the end point while using the BAR/BEAT/CLK Time Base, these values will be stored as follows when they are held if Display Resolution mode has been set to on:

The following example uses a time signature of 4/4.

"001^{BAR}, "1^{BEAT}, "46^{CLK} -> "001^{BAR}, "1^{BEAT}, "00^{CLK} (CLK value is cut off.)

"002^{BAR}, "4^{BEAT}, "51^{CLK} -> "003^{BAR}, "1^{BEAT}, "00^{CLK} (CLK value is rounded up.)

1. Press the DISP SEL key to select "SETUP" and press the EXECUTE/YES key. ("SETUP" will light up.)

Turn the JOG dial to select blinking "rESoLu". The display will change to something similar to this, and the current value will appear. (The default setting is "oFF".)

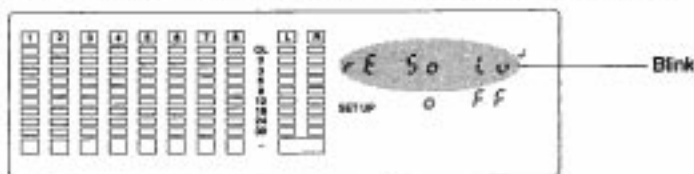

2. Press the EXECUTE/YES key again.

Letters "oFF" on the display will blink, and you can now edit the value.

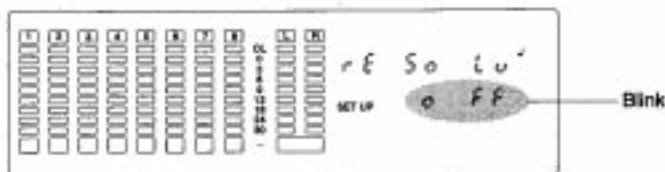

3. Use the JOG dial to select "oFF" or "on".

Turning the JOG dial counter-clockwise will select "oFF", and turning it clockwise will select "on".

4. Press the EXECUTE/YES key again.

The display in Step 1 will appear, and the setting is complete.

5. Press the STOP button or the EXIT/NO key to quit Setup mode.

15. Setting Slave mode On/Off ("SLAVE")

The "SLAVE" option in the Setup menu allows you to turn Slave mode on and off. When this mode is on, the DMT-8vL will be able to synchronize the MTC (MIDI time code) sent from the master DMT-8 ver2.0 (or D-80). (Along with the MTC, the master DMT-8 ver 2.0 (or D-80) will send digital signals to the slave DMT-8vL as a reference). This setting is effective only in the selected Program and will be maintained after you turn off the power.

1. Press the STORE key while pressing and holding down the HOLD/> key to select a Program.

2. Press the DISP SEL key to select "SETUP" and press the EXECUTE/YES key. ("SETUP" will light up.)

Turn the JOG dial to select blinking "SLAVE".

The display will change to something similar to this, and the current value will appear. (The default setting is "oFF".)

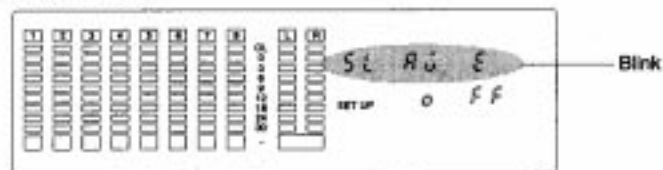

3. Press the EXECUTE/YES key again.

The letters "oFF" on the display will blink, and you can edit the value now.



4. Use the JOG dial to select "oFF" or "on".

Turning the JOG dial counter-clockwise will select "oFF", and turning it clockwise will select "on".

5. Press the EXECUTE/YES key again.

The display in Step 2 will appear, and the setting is complete.

<Note>

Do not connect or disconnect the optical cable to or from the DATA IN connector while the digital input is routed to any track. Otherwise, the DMT-8vL may generate noise, affecting the external device.

6. Press the STOP button or the EXIT/NO key to quit Setup mode.

<Note>

The DMT-8vL requires an external digital as well as an external MTC for its slave operation. Therefore, connect the DATA OUT terminal of the master D-80 or DMT-8vL to the DATA IN terminal of the slave unit using an optical cable. (You do not need to set any other settings on the master unit, since the master unit's DATA OUT connector always outputs digital signal.)

If you have not connected the units as described above (or in the slave unit does not receive digital signals correctly for some reason), the "DIGITAL" indicator of the slave unit will blink, indicating an error.

<Note>

You can perform normal recording and punch in/out recording on one of the DMT-8vLs even if it is syncing the external MTC (and digital signals) with Slave mode "ON". You can also select any "MIDI SYNC OUT" setting regardless of the Slave mode On/Off status.

<Note>

The DMT-8vL. Rebase window is fixed at "10 frames". That is, if the digital signal sent to the slave machine is interrupted (or if you try perform a sync operation using only the MTC, without sending any digital signal), the slave DMT-8vL will continue operating synchronization as long as the offset between the master and slave position is within 10 frames. However, if the offset exceeds 10 frames, the slave machine will adjust the position in relation to the master device position. (This is called a "Rebase operation.") Audio output will be muted during the rebase operation.

16. Setting MIDI device ID ("dEVicE")

The "dEVicE" in Setup menu allows you to set the device ID for controlling the DMT-8vL via MMC or Fostex System Exclusive Message sent from external sequencing software. (The transmit device ID is linked to this setting.) The range of the device ID is 00 through 99. (However, if the device ID number of the received message is "7F", the DMT-8vL will follow this message regardless of the device ID setting.) The setting will be shared by all Programs, and once you change this setting, the change will apply to all Programs. This setting is maintained after you turn off the power.

1. Press the DISP SEL key to select "SETUP" and press the EXECUTE/YES key.

("SETUP" indicator will light up.)

Turn the JOG dial to select the blinking "dEVicE".

The display will change to something similar to this, and the current value will appear. (The default setting is "00".)

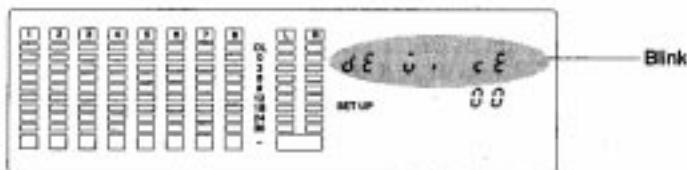

2. Press the EXECUTE/YES key again.

"00" on the display will blink, and you can now edit the value.



3. Use the JOG dial to set the value between 00 and 99.

Turning the JOG dial counter-clockwise will decrease the value, and turning it clockwise will increase it.

4. Press the EXECUTE/YES key again.

The display in Step 1 will appear, and the setting is complete.

5. Press the STOP button or the EXIT/NO key to quit Setup mode.

17. Setting the Undo function range ("Undo")

You can set an effective range for the Undo function in "Undo" in Setup mode. Two modes are available for the Undo function: "Edit": Non-destructive mode OFF - this mode allows for undo of auto punch in/out, copy & paste, and move & paste, and "ALL": Non-destructive mode ON - this mode allows for undo of all types of recording and editing.

<Note>

When executing direct recording in "undo ALL" mode, you need enough free disk space to accommodate real-time recording data. If you record a large amount of data in this mode, the remaining disk space may run out during your performance.

In this case, use the Undo function as soon as possible. (Once you perform any edit operation, you will not be able to use the Undo function.) To maximize the available disk space, cut an unnecessary part of another Programs, and move the ABS END point of each Program backward as much as possible.

1. Press the DISP SEL key to select "SETUP" and press the EXECUTE/YES key. ("SETUP" indicator will light up.)
Turn the JOG dial to select blinking "Undo".
The display will change to something similar to this, and the current value will appear. (The default setting is "Edit".)

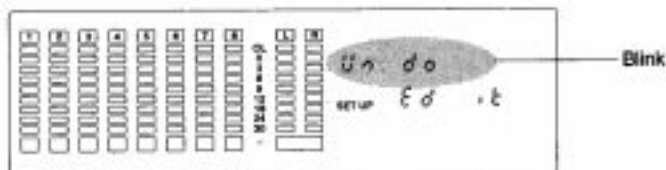

2. Press the EXECUTE/YES key again.
The letters "Edit" on the display will blink, and you can edit the value now.

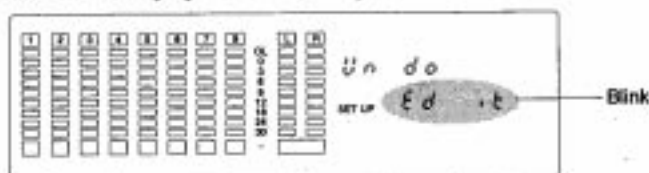

3. Use the JOG dial to select "Edit" or "ALL".
Turning the JOG dial counter-clockwise will select "Edit", and turning it clockwise will select "ALL".

"Edit" (Non-destructive mode off)	The Undo function is effective only on the Auto Punch In/Out, Paste, Erase, and Cut functions.
"ALL" (Non-destructive mode on)	The Undo function is effective on normal recording as well as the Auto Punch In/Out, Paste, Erase, and Cut functions.

4. Press the EXECUTE/YES key again.
The display in Step 1 will appear, and the setting is complete.
5. Press the STOP button or the EXIT/NO key to quit Setup mode.

(Digital Multitracker)

Model DMT-8VL

MIDI Implementation Chart

Date:
Version: V1.00

Function.....		Transmitted	Recognized	Remarks
Basic Channel	Default Changed	× ×	× ×	
Mode	Default Message Altered	× × *****	× × ×	
Note Number:	True voice	× *****	× ×	
Velocity	Note ON Note OFF	× ×	× ×	
After Touch	Key's Channel's	× ×	× ×	
Pitch Bend		×	×	
Control Change		×	×	
Program Change:	True #	× *****	× ×	
System Exclusive		○ (rem. 1)	○ (rem. 2)	
Common	: Quarter Frame : Song Position : Song Select : Tune	○ ○ × ×	○ × × ×	
System Real Time	: Clock : Commands	○ ○ (rem. 3)	× ×	
Aux. Message	: Local ON/OFF : All Notes OFF : Active Sense : Reset	× × × ×	× × × ×	
Notes		rem. 1: MMC (Device ID=00-99), MTC, Identity reply, Fostex Exclusive rem. 2: MMC (Device ID=00-99, 127), MTC Inquiry, Fostex Exclusive rem. 3: START, STOP, CONTINUE		

Mode 1: OMNI ON, POLY
Mode 3: OMNI OFF, POLYMode 2: OMNI ON, MONO
Mode 4: OMNI OFF, MONO○ : Yes
× : No

MMC Command List

● Command List	Movement (Recorder)
01 : STOP	STOP
02 : PLAY	PLAY
03 : DEFERRED PLAY	DEFERRED PLAY
04 : FAST FORWARD	F FWD
05 : REWIND	REWIND
06 : RECORD STROBE	REC
07 : RECORD EXIT	PUNCH OUT
09 : PAUSE	STOP
40 : WRITE	Refer to MMC Response/Information Field List
41 : MASKED WRITE	Refer to MMC Response/Information Field List
42 : READ	Refer to MMC Response/Information Field List
44 : LOCATE	LOCATE to Setting Data
47 : SHUTTLE	CUE/REVIEW ($\pm 1 \sim 60$ times)

● MMC Response/Information Field List	Command
01 : SELECTED TIME CODE	READ
48 : MOTION CONTROL TALLY	READ
4C : RECORD MODE	READ/WRITE
4E : TRACK RECORD STATUS	READ
4F : TRACK RECORD READY	READ/WRITE/MASKED WRITE
51 : RECORD MONITOR	READ/WRITE

Inquiry Message List

IDENTITY REQUEST : F0, 7E, 01, 06, 01, F7

IDENTITY REPLY : F0, 7E, 01, 06, 02, 51, 01, 00, 09, 00, 01, 00, 7F, 7F, F7

51 : Fostex ID

01, 00 : Device family code

09, 00 : Device family number DMT-8vt.

01, 00, 7F, 7F : Software version

Fostex MIDI System Exclusive Message Format for D-80/DMT-8 ver 2.0/DMT-8VL

<Note>

Following protocol is effective only in equipment which will reply by -

Identity Reply=F0 7E<channel>06 02 51 01 00 0A 00 01 00 7F 7F F7 (D-80)

Identity Reply=F0 7E<Channel>06 02 51 01 00 09 00 02 00 7F 7F F7 (DMT-8 ver 2.0)

Identity Reply=F0 7E<Channel>06 02 51 01 00 09 01 01 00 7F 7F F7 (DMT-8VL)

against the Inquiry Message=F0 7E<channel>06 01.

Fostex System Exclusive Message

General Structure=F0 51<device id><sub id 1>(<data>)F7

* Numbers are all expressed in hexadecimal units.

Table: <sub id 1> (<data>)

Command or Model Set Controller to D-80/DMT-8 ver 2.0/DMT-8VL	Acknowledge or Status D-80/DMT-8 ver 2.0/DMT-8VL to Controller
Loop on/off 12 22 (<on/off>)	
Post locate 12 28 (<post locate mode>)	
Auto rec 12 2D (<on/off>)	32 2D (<edit message>)
Lock enable 12 41 (<lock enable>)	
Copy clip 12 45 (<count><mmc track>)	32 45 (<edit message>)
Copy paste 12 46 (<count=01><repeat count>) or 12 46 (<count><repeat count><mmc track>)	32 46 (<edit message>)
Erase 12 47 (<count><mmc track>)	32 47 (<edit message>)
Cut 12 48	32 48 (<edit message>)
Clipboard play 12 49	32 49 (<edit message><mmc track>)
Undo 12 4A	32 4A (<edit message>)
Redo 12 4B	32 4B (<edit message>)
Nondes. mode 12 4C (on/off) * Refer to Note 1.	
Move clip 12 4D (<count><mmc track>)	32 4D (<edit message>)
Move paste 12 4E (<count=01><repeat count>) or 12 4E (<count><repeat count><mmc track>)	32 4E (<edit message>)
Digital in ch. 13 41 (<channel><channel>)	
Digital out ch. 13 42 (<channel><channel>) * Refer to Note 2.	
Program change 13 43 (<program>)	
Click on/off 13 44 (on/off)	

Status Request

Status request command Controller to D-80/DMT-8 ver 2.0/DMT-8vL		Status reply D-80/DMT-8 ver 2.0/DMT-8vL to controller
Loop op. status	22 21	32 21 (<Loop op. mode = 12>)
Loop status	22 22	32 22 (<on/off>)
Post locate status	22 28	32 28 (<post locate status>)
Auto rec status	22 2D	32 2D (<edit message>)
Lock status	22 41	32 41 (<lock status>)
Copy clip status	22 45	32 45 (<edit message=01 or =14>)
Copy paste status	22 46	32 46 (<edit message=02><mmc time>)
		or 32 46 (<edit message=00>)
Erase status	22 47	32 47 (<edit message=02><mmc time>)
		or 32 47 (<edit message=00>)
Nondes. mode	22 4C	32 4C (<on/off>)
Move clip status	22 4D	32 4D (<edit message=01 or =14>)
Move paste status	22 4E	32 4E (<edit message=02><mmc time>)
		or 32 4E (<edit message=00>)
Digital in ch. st.	23 41	33 41 (<channel><channel>)
Digital out ch. st.	23 42	33 42 (<channel><channel>)
Program status	23 43	33 43 (<program>)
Click status	23 44	33 44 (<on/off>)
Level status	23 45	33 45 (<count=08><level data>)

<Note 1>**Nondes.mode:**

Abbreviation for "non destructive recording mode". When this mode is ON, not only "takes" made by various sound editing or AUTO PUNCH IN/OUT but "takes" recorded by simultaneous pressing of the PLAY and RECORD buttons (direct recording) will always be possible to UNDO (However, free disc memory space equivalent to the recording length will always be required). This is the same function of switching between "undo:ALL (Nondes.mode:on) ↔ Edit (Nondes.mode:off)" in the setup menu on the main unit.

<Note 2>

There is a limitation on specifying the <channel><channel> setting. For details, refer to "Explanation on Command/Mode Set" mentioned in later pages.

EXPLANATION ON READ/WRITE INTO THE VARIOUS EDIT POINT MEMORY

The MMC response/information field "GP0~GP6" are allotted in the edit point memories (clipboard in, clipboard out, auto punch in, auto punch out memory, etc.) which is necessary at editing. Therefore, at registering and readout of the edit point memory, the "WRITE (40)" command and the "READ (42)" command of MMC must be used. Relationship between the Edit point memory of D-80/DMT-8 ver2.0/DMT-8vL and GP0~GP6 are shown below:

<Response/Information Field>

08 GP0 : locate memory

0A GP2 : clipboard out memory

0C GP4 : auto punch in memory

0E GP6 : end memory

09 GP1 : clipboard in memory

0B GP3 : start memory

0D GP5 : auto punch out memory

0F GP7 : reserved

Data Type

<loop op.mode>	12=stop Indicates the next operating mode following locating to the start point (GP3) upon arriving at the end point (GP6) by the play mode. In D-80/DMT-8, 12=stop only is effective.
<post locate mode>	12=stop 15=play Specifies operating mode in which D-80/DMT-8 should enter upon completing the locate operation. Corresponds to the setting of AUTO PLAY ON ("15")/OFF ("12") on the main unit.
<count>	01~7F Specifies succeeding data byte numbers.
<mmc track>	Complies to the MMC (MIDI MACHINE CONTROL) standard track bit map. In D-80/DMT-8, you always need to specify two byte combinations of "r0" and "r1."
<edit message>	00 = no message 01 = completed (completion flag) 02 = active (execution flag) 02<mmc time> = Indicates unprocessed time by active (execution flag) and <mmc time>. 02<count><mmc track> = Indicates source track by active (execution flag) and <mmc track>. Used for clipboard play. 03 = cancel (execution stop) 05 = Indicates rehearsal (rehearsal mode of auto rec). Possible of undo. 06 = Indicates take (take mode of auto rec). Possible of undo. 10 = over value error 10 <mmc time> = Capacity shortage time is indicated by over value error (error by capacity shortage) and <mmc time>. In copy paste, it indicates capacity shortage time required for a minimum one time paste. 11 = Indicates in point error (incorrect in point). 12 = Indicates out point error (incorrect out point). 14 = Indicates void data (data necessary for paste does not exist). 18 = Indicates track select error (track necessary to execute copy/move or erase/cut is not correctly setup). 19<repeat count> = Indicates repeat number error and repeat numbers executable by <repeat count>. 1A = Indicates disable rec (record disable mode). 25 = Indicates can't undo rehearsal (rehearsal mode of auto rec). Impossible to undo. 26 = Indicates can't undo take (take mode of auto rec). Impossible to undo. 71 = Indicates on. 72 = Indicates off.
<mmc time>	hr mn sc fr [fl/st] complies to the MMC standard time code.
<on/off>	70 = default 71 = on 72 = off
<repeat count>	01~7F Especially when executing commands such as paste, the number of pasting times to be continuously repeated following the auto punch in point is specified.
<channel>	00~08 Selects tracks 1~8 of the recorder section. "00" means that no setup (default setup) is made.
<lock enable>	00 = lock disable, chase disable 01 = lock enable, chase enable Corresponds to SLAVE ON ("01")/OFF ("00") in the main unit.
<lock status>	00 = lock disable, chase disable 01 = lock enable (unlocked), chase enable (unlocked) 11 = lock enable (locked), chase enable (locked)
<program>	01~7F Indicates program numbers (P1~P5) on the main unit. However, D-80/DMT-8 can specify only 01 (corresponds to P1)~05 (corresponds to P5).
<level data>	t1, t2 tn n: Indicates the track number. tn: Indicates absolute 8 bits of the Audio 16 bit data (Range: 00~7F).

Explanation on the Command/Mode Set

12 22 (<on/off>): loop on/off command

The command for setting the "loop mode on/off" (=ON/OFF of AUTO RTN) of D-80/DMT-8 ver2.0/DMT-8vL. Default figure of the loop operation mode is "12-stop" and this cannot be changed.

12 28 (<post locate mode>): post locate command

The command for setting the "post locate mode" (=ON/OFF of AUTO PLAY) of D-80/DMT-8 ver2.0/DMT-8vL. It will stop after locating if "post locate mode=12." It will enter play after locating if "post locate mode=15."

12 2D (<on/off>): auto rec command

The command for setting "auto rec mode on/off" (=ON/OFF of AUTO PUNCH) of D-80/DMT-8 ver2.0/DMT-8vL. Upon receiving this command, D-80/DMT-8 ver2.0/DMT-8vL will immediately reply the operating condition by sending "32 2D (<edit message>)".

12 41 (<lock enable>): lock enable command

The command for setting "slave mode on/off" (setup menu) of D-80/DMT-8 ver2.0/DMT-8vL.

12 45 (<count><mmc track>): copy clip command

When this command is received, D-80/DMT-8 ver2.0/DMT-8vL will copy (multiple number of tracks can be copied simultaneously) the sound data, as data for copy paste, from the pre-registered clipboard-in point to the clipboard-out point in the track specified by <mmc track>.

With completion of copying the data into the clipboard, D-80/DMT-8 ver2.0/DMT-8vL will immediately reply with "32 45 (<edit message=01 (completed)>)".

If copy cannot be executed due to improper figures of the pre-registered clipboard in/clipboard out points or incorrect track section, the corresponding <edit message> will be returned.

12 46 (<count=1><repeat count>): copy paste command

12 46 (<count><repeat count><mmc track>): copy paste command

When this command is received, D-80/DMT-8 ver2.0/DMT-8vL will paste the sound data which has been copied into the clipboard, on the same track from the pre-registered auto punch in point ever, if the sound data length in the clipboard is less than 10ms, the specifying the <repeat count> will be limited to "01."

Also, by specifying <mmc track>, paste can be executed on other tracks in mono (in one track units) or stereo units (in combinations of tracks 1 & 2, 3 & 4, 5 & 6, 7 & 8).

Since time corresponding to length of the copy clipped sound data is required to complete the copy paste operation, D-80/DMT-8 ver2.0/DMT-8vL immediately replies with "32 46 (<edit message=02 (active)>)" after receiving the command.

Successively upon completing the paste operation, "32 46 (<edit message=01 (completed)>)" is transmitted.

If paste cannot be executed due to improper figures of the pre-registered auto punch in point, insufficient disc capacity, no sound data in the clipboard, etc., the corresponding <editmessage> will be replied.

12 47 (<count><mmc track>): erase command

When this command is received, D-80/DMT-8 ver2.0/DMT-8vL will erase the data (writes in "0" data) in the section from the pre-registered auto punch in point through auto punch out point in the track specified by <mmc track>. Since time corresponding to length of the erase section is required to complete the erase operation, D-80/DMT-8 will immediately reply by "32 47 (<edit message=02 (active)>)" after receiving the command.

After the completion of erase operation, "32 47 (<edit message=01 (completed)>)" will be transmitted.

If erase cannot be executed due to improper figures of the pre-registered auto punch in point/auto punch out point, incorrect track section, etc., the corresponding <edit message> will be replied.

12 48: cut

When this command is received, D-80/DMT-8 ver2.0/DMT-8vi will cut whole the section following the pre-recorded auto punch in point under the assumption that whole the tracks are nonrecorded section. With completion of the cut operation, this equipment will immediately reply with "32 48 (<edit message=01 (completed)>)." If cut is unexecutable due to improper figure of the pre-registered auto punch in point, the corresponding <edit message> will be replied.

12 49: clipboard play

When this command is received, D-80/DMT-8 ver2.0/DMT-8vi will playback once from the head of the sound data copied in the clipboard by the copy clip and move clip commands.

Immediately after receiving the command, D-80/DMT-8 ver2.0/DMT-8vi will reply with "32 49 (<edit message=02 (active)><mmc track>)." The sound data track number is indicated by <mmc track>.

Upon completion of playback, "32 49 (<edit message=01 (completed)>)" is sent and clipboard play is ended. If there is no sound data in the clipboard, "32 49 (<edit message=14 (void data)>)" will be sent and clipboard play operation will be interrupted.

12 4A: undo

Upon receiving this command, D-80/DMT-8 ver2.0/DMT-8vi will revert to the condition prior to editing copy paste, erase, move paste, cut, redo operation. With completion of undo operation, D-80/DMT-8 ver2.0/DMT-8vi will reply with "32 4A (<edit message=01 (completed)>)." If D-80/DMT-8 ver2.0/DMT-8vi is not possible to undo, "32 4A (<edit message=00 (no message)>)" will be replied.

If D-80/DMT-8 ver2.0/DMT-8vi is not possible to undo, "32 4A (<edit message=00 (no message)>)" will be replied.

12 4B: redo

When this command is received, D-80/DMT-8 ver2.0/DMT-8vi will return to the condition prior to undo operation.

With completion of redo operation, D-80/DMT-8 ver2.0/DMT-8vi will reply with "32 4B (<edit message=01 (completed)>)." If D-80/DMT-8 ver2.0/DMT-8vi is not possible to redo, "32 4B (<edit message=00 (no message)>)" will be replied.

If D-80/DMT-8 ver2.0/DMT-8vi is not possible to redo, "32 4B (<edit message=00 (no message)>)" will be replied.

12 4C: (<on/off>) : nondes. mode

The command for setting on/off of non destructive mode on D-80/DMT-8.

If <on/off> is set to "on," recording mode of D-80/DMT-8 ver2.0/DMT-8vi will enter the non destructive mode, and if "off," in the destructive mode.

※ Nondes. mode:

Abbreviation for "non destructive recording mode". When this mode is ON, not only "takes" made by various sound editing or AUTO PUNCH IN/OUT but "takes" recorded by simultaneous pressing of the PLAY and RECORD buttons (direct recording) will always be possible to UNDO (However, free disc memory space equivalent to the recording length will always be required). This is the same function of switching between "undo: ALL (Nondes.mode:on) ↔ Edit (Nondes.mode:off)" in the setup menu on the main unit.

12 4D (<count><mmc track>): move clip command

When this command is received, D-80/DMT-8 ver2.0/DMT-8vi will copy (multiple tracks can be copied simultaneously) the sound data from the pre-registered clipboard in point to the clipboard out point, as data for move paste operation.

With completion copying the data into the clipboard, D-80/DMT-8 ver2.0/DMT-8vi will immediately reply with "32 4D (<edit message=01 (completed)>)."

If copy cannot be executed by the reason of pre-registered improper clipboard in/clipboard out point figures or incorrect track section, etc., the corresponding <edit message> will be replied.

12 4E (<count=1><repeat count>): move paste command

12 4E (<count><repeat count><mmc track>): move paste command

When this command is received, D-80/DMT-8 ver2.0/DMT-8vi will paste the sound data which have been move clipped in the clipboard, for the number of times specified by <repeat count> on the same track from the pre-registered auto punch in point as the starting point.

At the same time, the move clipped original sound data will be erased (data "0" is written in). However, when sound data length in the clipboard is less than 10ms, specifying the <repeat count> will be limited to "01."

Also, by specifying the <mmc track>, paste operation can be executed on other tracks in mono (one track unit) or stereo units (tracks 1 & 2, 3 & 4, 5 & 6, 7 & 8).

Since time corresponding to length of the move clipped sound data is required to complete the move paste operation, D-80/DMT-8 ver2.0/DMT-8vi will immediately reply with "32 4E (<edit message=02 (active)>)" after receiving the command.

Following completion of the move paste operation, "32 4E (<edit message = 01 (completed)>)" will be sent.

If paste cannot be executed due to improper figures of the previously registered auto punch in point, insufficient disc capacity, no sound data is in the clipboard, etc., the corresponding <edit message> will be replied.

13 41 (<channel><channel>): digital in ch.select command

The command assigning the digital audio signal (S/P DIF) input from the D-80/DMT-8 ver2.0/DMT-8vi DATA IN connector to the track specified by <channel>. The digital audio signal L channel assignment point is specified by the first <channel> and the R channel assignment point by the second <channel> in the command. If the same figure is specified for both <channels>, L channel will have priority and R channel will be "-" (invalid).

13 42 (<channel><channel>): digital out ch.select command

This command selects the source track for the digital audio signal (S/P DIF) output from the D-80/DMT-8 ver2.0/DMT-8vi DATA OUT connector.

Normally, the track specified by the first <channel> will be the digital audio signal L channel data, and the track specified by the second <channel> will be the digital audio signal R channel data. In this equipment, the five types - (<01><02>), (<03><04>), (<05><06>), (<07><08>) and (<00><00>) - can only be set up. Also, when (<00><00>) is specified, default (L-, R-, No Assign) will be set up in D-80, and (L:L, R:R) will be set up in DMT-8 ver2.0/DMT-8vi. Thus the mixer section stereo bus output will be assigned on DMT-8 ver2.0/DMT-8vi.

13 43(<program>):program change command

The command for PROGRAM CHANGE of D-80/DMT-8 ver2.0/DMT-8vi. The present program number can be changed to the figure indicated by <program>.

13 44 (<on/off>): click on/off command

The command for setting the metronome on/off of D-80/DMT-8 ver2.0/DMT-8vL. When ON is set, the metronome signal will be fed to the track 8 output (analog output only) of D-80/DMT-8 ver2.0/DMT-8vL.

The Status Request Command

22 21: loop operation status request

The command inquiring the loop operation mode setup status.
D-80/DMT-8 ver2.0/DMT-8vL will reply with "32 21 (<loop op.mode=12>)."

22 22: loop on/off status request

The command inquiring the loop on/off (=ON/OFF of AUTO RETURN) setup status.
D-80/DMT-8 ver2.0/DMT-8vL will reply with "32 22 (<on/off>)."

22 28: post locate status request

The command inquiring the post locate mode (ON/OFF of AUTO PLAY) setup status.
D-80/DMT-8 ver2.0/DMT-8vL will reply with "32 28 (<post locate mode>)."

22 2D: auto rec status request

The command inquiring the auto rec mode setup status and this is replied by "32 2D (<edit message>)." Reply from D-80/DMT-8 ver2.0/DMT-8vL against this status request will be either one of the following:

<edit message> -05: Possible to undo rehearsal mode.
 -06: Possible to undo take mode.
 -25: Impossible to undo rehearsal mode.
 -26: Impossible to undo take mode.
 -72: off

22 41: lock status request

The command inquiring the slave on/off setup status and the lock status.
D-80/DMT-8 ver2.0/DMT-8vL will reply with "32 41 (<lock status>)."

22 45: copy clip status request

The command inquiring the clipboard condition. If there is a copy paste data in the clipboard, D-80/DMT-8 ver2.0/DMT-8vL will reply with "32 45 (<edit message=01>)." If data in the clipboard is for move paste or there is no valid data in it, it will reply will "32 45 (<edit message=14 (void data)>)."

22 46: copy paste status request

The command inquiring execution status of copy paste editing.
When this command is received, D-80/DMT-8 ver2.0/DMT-8vL will reply with either "32 46 (<edit message=02><mmc time>)" or "32 46 (<edit message=00>)." <mmc time> indicates unprocessed time until completion.

22 47: erase status request

The command inquiring execution status of erase.
When this command is received, D-80/DMT-8 ver2.0/DMT-8vL will reply by either "32 47 (<edit message=02><mmc time>)" or "32 47 (<edit message=00>)." <mmc time> indicates unprocessed time until completion.

22 4C: nondes.mode request

The command inquiring the non destructive mode status.

When this command is received, D-80/DMT-8 ver2.0/DMT-8vi will reply with "32 4C (<on/off>)."

※ Nondes.mode:

Abbreviation for "non destructive recording mode". When this mode is ON, not only "takes" made by various sound editing or AUTO PUNCH IN/OUT but "takes" recorded by simultaneous pressing of the PLAY and RECORD buttons (direct recording) will always be possible to UNDO (However, free disc memory space equivalent to the recording length will always be required). This is same function of switching between "undo: ALL (Nondes.mode:on) ←→ Edit (Nondes.mode:off)" in the setup menu on the main unit.

22 4D: move clip status request

The command inquiring the clipboard status. If there is a move paste data on the clipboard, D-80/DMT-8 ver2.0/DMT-8vi will reply with "32 4D (<edit message=01>)." If data in the clipboard is for copy paste or there is no valid data on it, "32 4D (<edit message=14 (void data)>)" will be replied.

22 4E: move paste status request

The command inquiring the move paste execution status.

When this command is received, D-80/DMT-8 ver2.0/DMT-8vi will reply with "32 4E (<edit message=02><mmc time>)" or "32 4E (<edit message=00>)." <mmc time> indicates unprocessed time until completion.

23 41: digital in channel status request

The command inquiring the digital in channel setup status.

When this command is received, D-80/DMT-8 ver2.0/DMT-8vi will reply with "33 41 (<channel><channel>)."

23 42: digital out channel status request

The inquiring the digital out channel setup status.

When this command is received, D-80/DMT-8 ver2.0/DMT-8vi will reply with "33 42 (<channel><channel>)."

23 43: program status request

The command inquiring the presently operating program number.

When this command is received, D-80/DMT-8 ver2.0/DMT-8vi will reply with "33 43 (<program>)."

23 44: click on/off status request

The command inquiring the metronome on/off status of D-80/DMT-8.

When this command is received, D-80/DMT-8 ver2.0/DMT-8vi will reply with "33 44 (<on/off>)."

23 45: level status request

The command inquiring the present output level data of the 1A`8 tracks. In D-80/DMT-8, as the level data is updated about every 40msec., inquiry in 40msec. units is effective. When this command is received, D-80/DMT-8 ver2.0/DMT-8vi will reply with "33 45 (<count=08><level data>)."

Explanation on the Status Reply

32 21 (<loop op.mode>): loop operation mode status

This is the reply against the "22 21" loop operation status request command. <loop op.mode=12> is the only status data of D-80/DMT-8 ver2.0/DMT-8vi and any other setting is not permissible.

32 22 (<on/off>): loop on/off status

This is the reply against "22 22" loop on/off status request.

32 28 (<post locate mode>): post locate mode status

This is the reply against "22 28" post locate status request. <post locate mode=12 or 15> is the only status data of D-80/DMT-8 ver2.0/DMT-8vi and any other setting is not permissible.

32 2D (<edit message>): auto rec status

This is the reply against the "12 2D" auto rec command or the "22 2D" auto rec status request.

32 41 (<lock status>): lock status

This is the reply against the "22 41" lock status request.

32 45 (<edit message>): copy clip status

This is the reply against the "12 45" copy clip command or the "22 45" copy clip status request.

32 46 (<edit message>): copy paste status

32 46 (<edit message><mmc time>): copy paste status

This is the reply against the "12 46" copy paste command or the "22 46" copy paste status request. <mmc time> indicates the unprocessed time until completion of copy paste editing.

32 47 (<edit message>): erase status

32 47 (<edit message><mmc time>): erase status

This is the reply against "12 47" erase command or "22 47" erase status request.

32 48 (<edit message>): cut status

This is the reply against the "12 48" cut command.

32 49 (<edit message><mmc track>): clipboard play status

This is the reply against the "12 49" clipboard play command. If there is no sound data in the clipboard, "32 49"(<edit message=14 (void data)>)" will be replied. <mmc track> indicates the sound data track number.

32 4A (<edit message>): undo status

This is the reply against the "12 4A" undo command. Either <edit message=01 (completed) or <edit message=00 (no message)> will be replied.

32 4B (<edit message>): redo status

This is the reply against the "12 4B" redo command. Either <edit message=01 (completed) or <edit message=00 (no message)> will be replied.

32 4C (<on/off>): nondes.mode status

This is the reply against the "22 4C" nondes.mode status request.

32 4D (<edit message>): move clip status

This is the reply against the "12 4D" move clip command or "22 4D" move clip status request.

32 4E (<edit message>): move paste status

32 4E (<edit message><mmc time>): move paste status

The reply against the "12 4E" move paste command or the "22 4E" move paste status request.

<mmc time> indicates the unprocessed time until completion of move paste editing.

33 41 (<channel><channel>): digital in channel status

This is the reply against the "23 41" digital in ch.st.request.

The first <channel> indicates the track number to which the L channel digital audio signal from the DATA IN connector is assigned and the second <channel> indicates the assigned track number for the R channel.

33 42 (<channel><channel>): digital out channel status

This is the reply against the "23 42" digital out ch.st.request.

It indicates that the track indicated by the first <channel> in the command is assigned to the L channel output of the digital audio signal output from DATA OUT, and the track specified by the second <channel> is assigned to the R channel output.

33 43 (<program>): program status

This is the reply against the "23 43" program status request.

<program> indicates the presently operating program number.

33 44 (<on/off>): click status

This is the reply against the "23 44" click status request.

It indicates the on/off setting of the metronome function.

33 45 (<count=08><level data>): level status

This is the reply against the "23 45" level status request and it indicates the present track 1~8 output level data.

In D-80/DMT-8 ver2.0/DMT-8vi, as level data is updated 40msec., it will be effective if inquiry is made in 40msec. units.

Maintenance

Cleaning the exterior

* For normal cleaning, use a soft dry cloth.

For stubborn dirt, moisten a cloth in diluted detergent, wring it out firmly, and wipe the dirt off. Then polish with a dry cloth.

Never use solvents such as alcohol, thinner or benzene, since these will damage the printing and finish of the exterior.

Specifications

Mixer Section

Input/Output

INPUT (1, 2)

Connector : ϕ 6mm PHONE jack (\times 2)
 Input impedance : 20k Ω or more
 Input level : -10dBV (H), -30dBV (M), -50dBV (L) (Switchable)

INPUT (3 ~ 8)

Connector : ϕ 6mm PHONE jack (\times 6)
 Input impedance : 20k Ω or more
 Input level : -10dBV

AUX SEND 1, 2

Connector : ϕ 6mm PHONE jack (\times 2)
 Load impedance : 10k Ω or more
 Output level : -10dBV

AUX RTN 1, 2 (L, R)

Connector : ϕ 6mm PHONE jack (\times 4)
 Input impedance : 20k Ω or more
 Input level : -20dBV

STEREO OUT (L, R)

Connector : RCA pin jack (\times 2)
 Load impedance : 10k Ω or more
 Output level : -10dBV

MONITOR OUT (L, R)

Connector : ϕ 6mm PHONE jack (\times 2)
 Load impedance : 10k Ω or more
 Output level : -10dBV

HEADPHONE OUT

Connector : ϕ 6mm STEREO PHONE jack (\times 1)
 Load impedance : 8 Ω or more
 Maximum Output : 100mW (at 50 Ω)

EQUALIZER

Shelving type

HI : 10kHz \pm 15dB
 LOW : 100Hz \pm 15dB

FREQUENCY RESPONSE : 20Hz ~ 20kHz

Recorder Section**Input/Output****RECORDER IN**

Connector : RCA pin jack (× 2)
 Input impedance : 20k Ω or more
 Input level : -10dBV

RECORDER OUT

Connector : RCA pin jack (× 8)
 Load impedance : 10k Ω or more
 Output level : -10dBV

DATA IN/OUT

Connector : Optical (× 2)
 Format : IEC 958 Part 2 (-S/P DIF)

MIDI IN/OUT

Connector : DIN 5PIN (× 2)
 Format : MIDI standard

PUNCH IN/OUT

Connector : φ 6 Phone Jack (× 1)
 (An optional FOOT SW Model 8051 can be connected.)

Recording/Reproducing

Recording medium : 3.5 inch, E-IDE type hard disk × 1
 Recording format : FDMS*-2 (*: Fostex Disk Management System)
 Save/Load format : FDIO*-1 (*: Fostex Data In/Out)
 Sampling frequency : 44.1kHz
 Quantization : 16-bit linear
 A/D: 18-bit 64-time, over sampling, Delta-Sigma
 D/A: 20-bit 128-time, over sampling, Delta-Sigma
 Recording time : approx. 12 minutes (When installing the 540MB hard disk unit)
 : approx. 30 minutes (When installing the 1.3GB hard disk unit)
 No. of recording track : 8 tracks
 Program No. : Maximum 5 tunes
 Crossfade : 10msec.
 Recording/reproducing frequency : 20Hz ~ 20kHz
 Dynamic range : 92dB
 Total harmonic distortion : 0.008%

General

Dimensions : 537 (W) × 106 (H) × 346 (D) mm
 Weight : approx. 8.0 kg
 Power supply : 120VAC 60Hz
 : 230V~ 50/60Hz
 Power consumption : approx. 33W

* Specifications and appearance are subject to change without notice for product improvement.

Block diagram

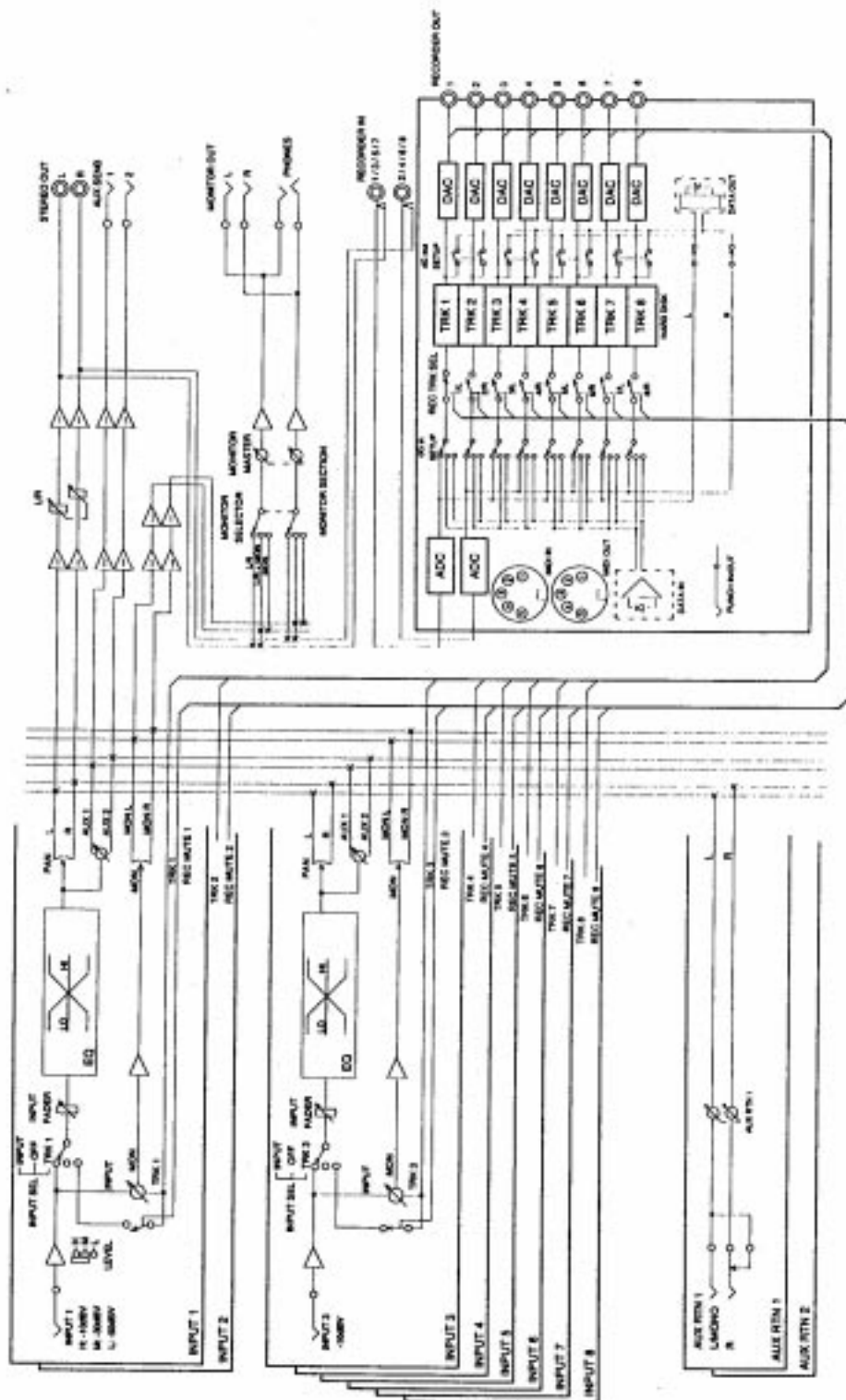

INDEX

[A]

About copyrights	8
About damages	8
AUX send knob	15
AUX return knob	15
Auto play/Auto return key	23
Auto punch mode ON/OFF key	21
Auto punch in key	18
Auto punch out key	18
Auto return start key	18
Auto return end key	18
ABS time display	29
ABS	38
Analog recording	46
Application guide	65
Auto Punch In/Out rehearsal mode	80
Auto Punch In/Out take mode	82
Auto play mode	88
Auto return mode	88
Auto repeat mode	92

[B]

BAR/BEAT/CLK display	29
Before operating the DMT-8vt.	34
BAR/BEAT/CLK	38, 113
Basic recording and playback	46

[C]

Clipboard in key	23
Clipboard out key	22
Copy key	22
Changing Programs	36, 50
Changing the stored start/end point	91
Copy and Paste	94
Copying	94
Copy & pasting	96
Cutting	106
CAN'T UNDO	31

[D]

Display section	27
Display select key	23
DATA IN connector	26
DATA OUT connector	26
DISK remain display	28
Disk error indication	33
Difference between track and channel	35
Difference from a tape MTR	36
Default settings on the DMT-8vt.	45
Digital recording	62, 64
Disable	128

[E]

Erase key	19
Execute/Yes key	24
Exit/No key	24
Event overflow indication	32
Effect connection	39
Editing and storing the start/end point	90

Edit function	93
Erasing	105
Entering Setup mode	108

[F]

Fast forward button	20
Function of the PAN knob	35
Formatting the hard disk	44, 123
Frame rate	67, 69, 126
Four-tracks simultaneous recording	75
Fostex System Exclusive Message	138

[H]

High equalizer control knob	15
Hold/Digit move key	17
Hard disk operation LED	19
Hard disk	41

[I]

Introduction	6
Input select key	14
Input jack	25
Invalid data indication	31
Invalid In/Out indication	31
Input monitor	37
Inquiry message list	137
Installing a hard disk	42

[J]

Jog dial	19
----------	----

[L]

Low equalizer control knob	15
Locate key	21
Load error indication	32
Layout of the top panel	34
Level switch	14
Locate function	87
Loading data from a DAT machine	117

[M]

Main features	9
Monitor panpot	14
Monitor level knob	14
Master fader L/R	15
Monitor selector	15
Monitor master level knob	15
Meter display	27
MIDI IN connector	26
MIDI OUT connector	26
MTC display	29
MTC	38, 126, 127
Mixdown	60
MIDI clock synchronization system	67
MTC synchronization system	69
MMC REC Out function	71
Metronome function ON/OFF	116
MIDI SYNC OUT	125
MTC OFFSET	127
MIDI implementation chart	136

	MMC command list	137		Setting a digital output channel	131
	Maintenance	148		Setting display resolution mode ON/OFF	132
[N]	Notes about power supply	6		Setting Slave mode ON/OFF	72, 133
	Notes on handling the hard disk	7		Setting MIDI device ID	134
	Notes on the setup location	7		Setting the Undo function range	135
	Notes on repair	8		Specifications	148
			[T]	Timebase	38
[O]	Overtime indication	31			
	Overdubbing	52	[U]	Undo key	19
				Un-formatted indication	32
[P]	Panpot knob	14		Using only the recorder section	74
	Precautions	6		Undo/Redo of Auto Punch In/Out	82
	Paste key	21		Undo/Redo the paste operation	98, 103
	Play button	20		Undo/Redo the erase operation	106
	Punch in/out jack	26		Undo/Redo the cut operation	107
	Power switch	26			
	Preset display	27	[W]	Warning message	31
	Program change	30, 37, 50			
	Ping-pong recording	65			
	Punch In/Out	76			
	Punch In/Out recording using a foot switch	83			
	Punch In/Out rehearsal using a foot switch	84			
	Punch In/Out take using a foot switch	85			
	Preroll time	124			
[R]	Record track select key	16			
	Redo key	19			
	Recall key	19			
	Record button	21			
	Rewind button	20			
	Repro monitor	37			
	REC ENABLE/DISABLE	128			
[S]	Store key	17			
	Shuttle dial	19			
	Stop button	20			
	SETUP mode display	29, 108			
	Storing the Punch In point	78			
	Storing the Punch Out point	79			
	Setting the auto return start/end point	89			
	Storing the start/end point in real-time	89			
	SETUP mode	108			
	Setting the time signature	113			
	Setting tempo	114			
	Saving and Loading the recordings	117			
	Saving data to a DAT machine	119			
	Setting the preroll time for the locate operation	124			
	Selecting the synchronized signal output from the MIDI OUT connector	125			
	Setting the MTC frame rate	126			
	Setting MTC Offset time	127			
	Setting recording enable/disable mode	128			
	Setting a digital input channel	129			

FOSTEX DISTRIBUTORS LIST IN EUROPE

* Including non-EU countries.

* underlined: contracted distributors (as of Jun. 1, 1995)

<AUSTRIA>

NAME: A TEC Audio-u. Videogeraete VertriebsgesmbH.
ADD: Im Winkel 5, A-2325 Velm, Austria
TEL: (+43) 2234-74004, FAX: (+43) 2234-74074

<BELGIUM>

NAME: EML N.V.
ADD: Maastrichterstraat 323, 3740 Mopertingen-
Bilzen, Belgium
TEL: (+32) 89-415278, FAX: (+32) 89-491662

<DENMARK>

NAME: SC Sound ApS
ADD: Malervej 2, DK-2630 Taastrup, Denmark
TEL: (+45) 4399-8877, FAX: (+45) 4399-8077

<FINLAND>

NAME: Noretron Audio
ADD: Olarinluoma 7, FIN-02200 Espoo, Finland
TEL: (+358) 0-5259330, FAX: (+358) 0-52593352

<FRANCE>

NAME: Musikengro
ADD: ZAC de Follieuses, B. P. 609, 01706 Les Echets,
France
TEL: (+33) 72 26 27 00, FAX: (+33) 72 26 27 01

<GERMANY>

NAME: Studiosound & Music GmbH
ADD: Scheppe Gewissegasse 8, D-35039 Marburg,
Germany
TEL: (+49) 6421-12071, FAX: (+49) 6421-15522

<GREECE>

NAME: Bon Studio S. A.
ADD: 6 Zaimi Street, Exarchia, 106.83 Athens, Greece
TEL: (+30) 1-3809605-8, 3302059
FAX: (+30) 1-3845755

<ICELAND>

NAME: TH. Danielsson HF.
ADD: Skulagata 61, P.O. Box 5066, 125 Reykjavik,
Iceland
TEL: (+354) 588 5010, FAX: (+354) 588 5011

<ITALY>

NAME: Entel S. r. L.
ADD: V. 1 Maggio, N 18, 40050 Quarto Inferiore, (BO)
Italy
TEL: (+39) 51-768576, FAX: (+39) 51-768336

<NETHERLANDS>

NAME: IEMKE ROOS AUDIO B. V.
ADD: Kuiperweg 20, 1101 AG Amsterdam, The
Netherlands
TEL: (+31) 20-697-2121
FAX: (+31) 20-697-4201

<NORWAY>

NAME: Siv. Ing. Benum A/S
ADD: P. O. Box 145 Vinderen, 0319 Oslo 3, Norway
TEL: (+47) 22-145460, FAX: (+47) 22-148259

<PORTUGAL>

NAME: Caius - Tecnologias Audio e Musica, Lda.
ADD: Rua de Santa Catarina, 131 4000 Porto, Portugal
TEL: (+351) 2-2084456/325400
FAX: (+351) 2-314760

<SPAIN>

NAME: Multitracker S. A.
ADD: C/Garcilaso No.9, Madrid 28010, Spain
TEL: (+34) 1-4470700, 1-4470898
FAX: (+34) 1-5930716

<SWEDEN>

NAME: TTS Tal & Ton Studioteknik AB
ADD: Gelbgjutarevagen 4, S-171 48 Solna, Sweden
TEL: (+46) 8-7340750, FAX: (+46) 8-824476

<SWITZERLAND>

NAME: Audio Bauer Pro AG
ADD: Bernerstrasse-Nord 182, CH-8064 Zurich,
Switzerland
TEL: (+41) 1-4323230, FAX: (+41) 1-4326558

<UK>

NAME: SCV London
ADD: 3A 6-24 Southgate Road, London N1 3JJ,
England, UK
TEL: (+44) 171-923-1892
FAX: (+44) 171-241-3644

Declaration of EC Directive

This equipment is compatible with the EMC Directive (89/336/EEC) - Directive on approximation of member nation's ordinance concerning the electromagnetic compatibility and with the Low Voltage Directive (73/23/EEC) - Directive on approximation of member nation's ordinance connecting electric equipment designed to be used within the specified voltage range.

The Affect of Immunity on This Equipment

The affect of the European Specification EN50082-1 (coexistence of electromagnetic waves - common immunity specification) on this equipment are as shown below.

** In the electrical fast transient/burst requirements, radiate electromagnetic field requirements and static electricity discharging environment, this could be affected by generation of noise in some cases. The display content could also differ from actual figures.*

Please comply to the precautions below to make this equipment compatible with European Specification EN50082-1 (coexistence of electromagnetic waves - common immunity specification).

<NOTE>

*Caps are installed on the rear panel MIDI IN and MIDI OUT connectors.
The purpose of these caps are to prevent static electricity from affecting this equipment.
Do not remove these caps except when using the MIDI IN and MIDI OUT connectors.*

Fostex

FOSTEX CORPORATION

3-2-35 Musashino, Akishima-shi, Tokyo 196 Japan

FOSTEX CORPORATION OF AMERICA

15431, Blackburn Ave., Norwalk, CA 90650, U. S. A.

Fostex

FOSTEX CORPORATION

3-2-35 Musashino, Akishima-shi, Tokyo 196 Japan

FOSTEX CORPORATION OF AMERICA

15431, Blackburn Ave., Norwalk, CA 90650, U. S. A.