

Owner's Manual

Model

D-5

DIGITAL MASTER RECORDER

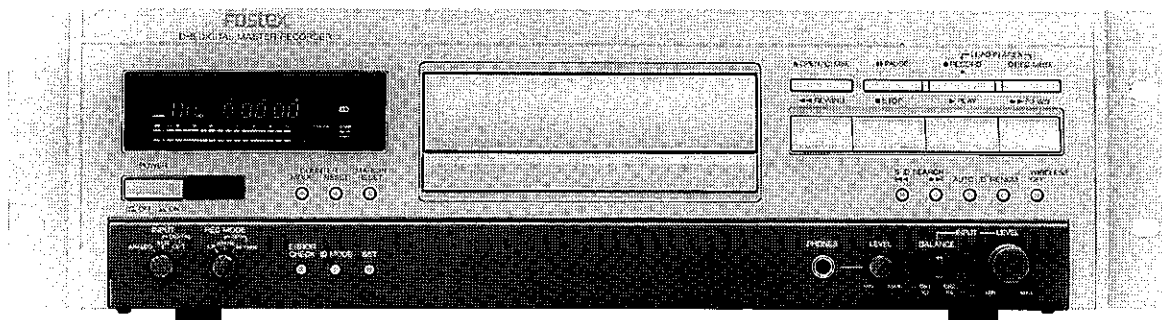

Fostex®

C

C

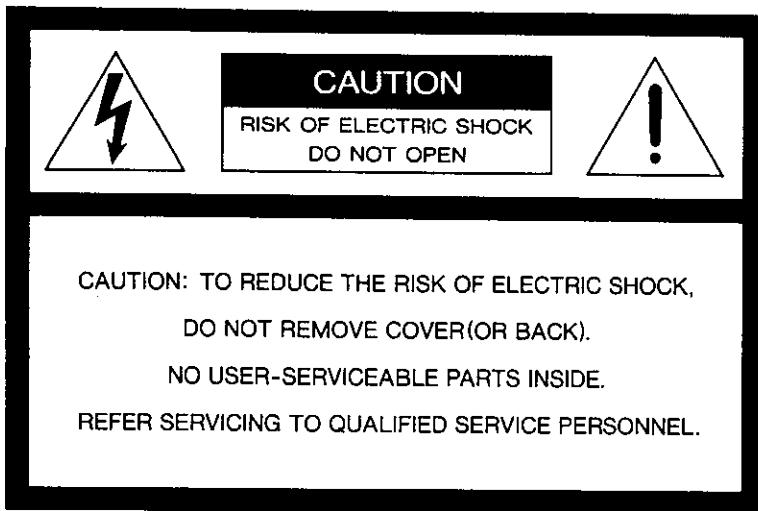

CAUTION:
 TO PREVENT ELECTRIC SHOCK, MATCH WIDE BLADE OF PLUG TO WIDE SLOT, FULLY INSERT.

ATTENTION:
 POUR ÉVITER LES CHOCS ÉLECTRIQUES, INTRODUIRE LA LAME LA PLUS LARGE DE LA FICHE DANS LA BORNE CORRESPONDANTE DE LA PRISE ET POUSSER JUSQU'AU FOND.



The lightning flash with arrowhead symbol, within an equilateral triangle, is intended to alert the user to the presence of uninsulated "dangerous voltage" within the product's enclosure that may be of sufficient magnitude to constitute a risk of electric shock to persons.



The exclamation point within an equilateral triangle is intended to alert the user to the presence of important operating and maintenance (servicing) instructions in the literature accompanying the appliance.

"WARNING"

"TO REDUCE THE RISK OF FIRE OR ELECTRIC SHOCK, DO NOT EXPOSE THIS APPLIANCE TO RAIN OR MOISTURE."

SAFETY INSTRUCTIONS

1. Read Instructions — All the safety and operating instructions should be read before the appliance is operated.
2. Retain Instructions — The safety and operating instructions should be retained for future reference.
3. Heed Warnings — All warnings on the appliance and in the operating instructions should be adhered to.
4. Follow Instructions — All operating and use instructions should be followed.
5. Water and Moisture — The appliance should not be used near water — for example, near a bathtub, washbowl, kitchen sink, laundry tub, in a wet basement, or near a swimming pool, and the like.
6. Carts and Stands — The appliance should be used only with a cart or stand that is recommended by the manufacturer.
7. Wall or Ceiling Mounting — The appliance should be mounted to a wall or ceiling only as recommended by the manufacturer.
8. Ventilation — The appliance should be situated so that its location or position does not interfere with its proper ventilation. For example, the appliance should not be situated on a bed, sofa, rug, or similar surface that may block the ventilation openings; or, placed in a built-in installation, such as a bookcase or cabinet that may impede the flow of air through the ventilation openings.
9. Heat — The appliance should be situated away from heat sources such as radiators, heat registers, stoves, or other appliances (including amplifiers) that produce heat.
10. Power Sources — The appliance should be connected to a power supply only of the type described in the operating instructions or as marked on the appliance.
11. Grounding or Polarization — The precautions that should be taken so that the grounding or polarization means of an appliance is not defeated.
12. Power Cord Protection — Power supply cords should be routed so that they are not likely to be walked on or pinched by items placed upon or against them, paying particular attention to cords at plugs, convenience receptacles, and the point where they exit from the appliance.
13. Cleaning — The appliance should be cleaned only as recommended by the manufacturer.
14. Nonuse Periods — The power cord of the appliance should be unplugged from the outlet when left unused for a long period of time.
15. Object and Liquid Entry — Care should be taken so that objects do not fall and liquids are not spilled into the enclosure through openings.
16. Damage Requiring Service — The appliance should be serviced by qualified service personnel when:
 - A. The power supply cord or the plug has been damaged; or
 - B. Objects have fallen, or liquid has been spilled into the appliance; or
 - C. The appliance has been exposed to rain; or
 - D. The appliance does not appear to operate normally or exhibits a marked change in performance; or
 - E. The appliance has been dropped, or the enclosure damaged.
17. Servicing — The user should not attempt to service the appliance beyond that described in the operating instructions. All other servicing should be referred to qualified service personnel.



An appliance and cart combination should be moved with care. Quick stops, excessive force, and uneven surfaces may cause the appliance and cart combination to overturn.

Introduction

Thank you for purchasing this Fostex product.

The Fostex Model D-5 Digital Master Recorder complies to AES/EBU specifications.

It can record and playback both analog and digital audio signals in high quality and furthermore, it is possible to edit sub-codes such as the START ID. We recommended that you read this manual carefully for correct operation. We advise, in particular, you to read "Precautions in Operation" before operating the D-5.

Table of Contents

1. Precautions In Operation.....	5
2. Main Features.....	8
3. Installation.....	9
4. The Remote Control Unit.....	10
5. Notes On Using DAT Cassette Tapes.....	11
6. Names and Functions of The Controls.....	13
6-1. Front Panel Section.....	13
6-2. Display Section.....	16
6-3. Rear Panel Section.....	19
6-4. Wireless Remote Controller.....	21
7. Basic Recording Process.....	22
7-1. Recording Analog Audio Signals.....	22
7-2. Recording Digital Audio Signals.....	27
8. Playback Procedure.....	30
8-1. Connections.....	30
8-2. Preparation to Playback.....	30
8-3. Basic Playback Procedure.....	31
8-4. Various Playback Methods.....	32
9. Sub Code Editing.....	37
9-1. The Sub Code.....	37
9-2. Automatic Recording of S-ID.....	39
9-3. Manual Recording of S-ID.....	40
9-4. Erasing Unnecessary S-ID.....	46
9-5. Recording the END-ID.....	47
9-6. Erasing the END-ID.....	48
9-7. Recording SKIP-ID at the Desired Point.....	49
9-8. Erasing Unnecessary SKIP-ID.....	50
Specifications.....	51

1. Precautions in Operation

For safety's sake....

To prevent fire, electric shocks and other troubles, it is advised to strictly adhere to the following precautions

Do not operate the D-5 in dusty or damp environments.

The D-5 must not be placed in dusty or damp locations.

Do not place the D-5 near room heaters.

Do not place the D-5 near heat emitting objects such as stoves or heaters or where it will be subject to direct sun light for long hours.

Do not place the D-5 on unstable tables or where it will be subject to strong vibrations.

Do not place it where it could fall.

Do not obstruct the ventilating holes.

Ventilating holes are provided to prevent high internal temperatures. Therefore, the D-5 must not be placed on long haired floor mats and rugs. Doing so could result in damage and possibly fire.

Do not allow liquids or foreign material to get inside the D-5.

Do not place cups filled with liquid on top of the D-5. Should any liquid be spilled inside, immediately disconnect the power cord from the wall socket and contact your Fostex Service Station.

If metallic objects such as a hair pins, coins or combustible materials such as papers and matches are dropped through the ventilating holes, breakdown, fire or electric shocks could result. Should any such foreign matter get inside, immediately disconnect the power cord from the wall socket and contact your Fostex Service Station.

Do not dismantle the D-5.

Do not open or remove the outer cabinet. There is a high tension circuit inside and you could receive a dangerous electric shock.

Never attempt to make any modifications as this could result in a dangerous situation. Fostex will not assume any responsibility for breakdown or performance deterioration due to modifications by the user.

Do not pull the power cord.

Always grasp the plug when connecting and disconnecting the power cord from the wall socket. Pulling on the cord will break the wire and create a dangerous situation. Also, do not grasp power cord with wet hands as you could receive an electric shock.

Disconnect the power cord plug from wall socket if you notice anything unusual.

Should any abnormal sound, smell or smoke is noticed, immediately pull out the power cord plug from the wall socket and consult your Fostex Service Station.

Disconnect the power cord plug from the wall socket if the equipment is not to be used for long periods.

As with all electrical equipment, when leaving the house for some length of time or for traveling, pull out plug from the wall socket for the sake of safety.

Use of batteries.

Batteries can burst or electrolyte leak out if they are incorrectly used.

- * Load batteries according to the plus (+) and minus (-) polarities indicated in the battery compartment.
- * Although batteries can be of the same shape and size voltages between them could be different. Therefore, do not mix batteries of different brands.
- * Remove batteries from the battery compartment if the equipment is not to be used for some length of time (one month) to prevent electrolyte leaking.
Should any electrolyte be spilled inside the battery compartment, wipe it clean before loading fresh cells.
- * Do not charge or short circuit the batteries included in the equipment package, nor dismantle them or throw them in a fire.

Do not use a power supply which is not specified.

This equipment must not be operated with a power supply other than specified.

Dewing

If the D-5 is cold and suddenly brought into a warm room or the temperature is suddenly raised, moisture will collect (dewing) on the mechanism and hinder performance of the recorder. In cold situations, either keep the D-5 in the room where it is to be used for about two hours or gradually raise the room temperature. If the equipment is operated with moisture inside or on the tape, the tape may stick to the rotating drum ruining the tape and possibly damaging the recorder.

DAT cassette tape can also collect moisture under these same conditions and therefore, should be used only after leaving it in the room for about two hours until its temperature balances with the environment.

Equipment Maintenance

Wipe the exterior of the D-5 with a soft dry cloth for routine cleaning. If the case is dirty, wipe with a damp cloth wetted with detergent diluted 5:1 or 6:1, and then wipe with a soft dry cloth. Be careful not to allow alcohol, lacquer thinners, benzine or insect spray to get on the outer cabinet as the printed letters and surface paint might be spoiled. Rubber and vinyl objects must not be allowed to touch the surface for long periods as they could stick to the surface and damage it. If cleaning cloths impregnated with cleaning chemicals are to be used, read the instruction sheet before use. Before cleaning, be sure to disconnect the power cord from the wall socket.

Head Clearing

With long hours of use, the head will become soiled and normal recording and playback will become difficult due to sound drop out during playback and also cause excess noise when recording. In such case, the head must be cleaned with a cleaning tape exclusively designed for DAT (*) or by using a head cleaning kit sold at audio equipment stores. If this cleaning does not restore the recorder to its original performance level, request your authorized service stations for inspection as the rotating head could possibly be worn out..

(*) Precautions when using a cleaning tape.

The cleaning tape must not be used excessively as it could wear out the rotating head. Thus, limit use of cleaning tape to about ten seconds.

2. Main Features

The D-5 has the following outstanding features.

High Speed AI Search

To reduce search time when selecting program playback, sub code information recorded on the tape is read to learn the music number and starting point of the tune, and using these data, AI search up to a maximum 300 X speed can be attained.

Extended Time Recording Mode

Analog input program sources can be recorded up to 2 X the standard mode (maximum is four hours when using standard 120 minute tape). For digital input program source, the 32kHz sampling frequency programs can be recorded in the "extended time recording mode."

Sub Code Applications

Various time information, START-ID indicating the starting point of the tune or SKIP-ID used for skipping undesired portion of the tune, P-NO. information and END-ID which indicates the end of the recording, can all be recorded and played back. In addition, editing of tape and TOC information used for making a library can be recorded and using these, AI search can be carried out.

Q Code Sync Start ID Recording (Only at OPTICAL input)

When recording from a compact disc, the Q code recorded on the compact disc is read and although there may be no sections of no-sound between tunes, the START-ID can be accurately recorded. Since this function will automatically switch ON when the computer acknowledges that the signal source is a compact disc, there is no need of any switching or controlling.

Last Memory Function

ON/OFF of the AUTO-ID or the input switch situation prior to the switch off of power will be retained in the memory.

High Quality Sound Circuit

The pulse flow one bit D/A converter, one bit wide range linear A/D converter and the clean clock circuit for suppressing the clock signal wavering in the time axis direction.

3. Installation

Remember the following to obtain best performance.

- * Place the recorder on a flat stable desk.
- * Do not place a speaker system adjacent to the recorder.
- * Do not place the recorder on top of a TV receiver or color monitor.
- * Do not place any object on top of the recorder.
- * Do not place the recorder on top of equipment emitting heat such as an amplifier.
- * In a rack installation with other audio equipment, use a lower shelf to avoid heat from amplifiers.
- * Do not set the recorder on long haired rugs or sofas. Doing so could hinder recorder ventilation and result in serious breakdown.

For safety's sake....

- * When mounting this D-5 on a rack, do not place a heavy object on top of the recorder. Excess weight could break the rack mount adapter dropping the recorder.
- * The D-5 is a high technology product using a microcomputer. To avoid mutual interference when using the recorder, it is advised to switch off TV sets or use it some distance away from the recorder.

4. The Remote Control Unit

A remote control unit with batteries is packaged with this recorder. Load the batteries as follows:

1. Open the rear lid and the batteries being careful of the polarity.

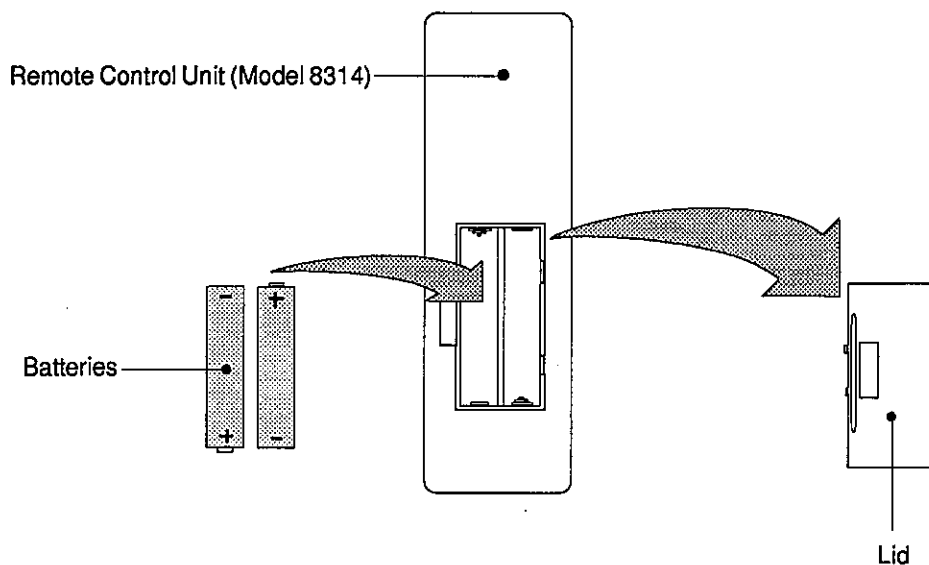

2. Close the lid.

PRECAUTIONS

- * Remove batteries from the remote control unit if it is not to be used for long periods (one month or more) to avoid damage from leaking electrolyte. Should there be any leaking, wipe off all electrolyte from inside the battery compartment and install fresh batteries.
- * Do not place anything on top of the remote control unit such as book. It could continue pressing the keys and thus exhaust the battery.

5. Notes on Using DAT Cassette Tapes

DAT Cassette System

Record/Playback is in one direction only. Unlike a compact cassette, a DAT cassette is of enclosed construction in which the tape and hub holes are covered with lids and sliders. In other words, it is constructed so as to prevent dust and small foreign particles from entering the cassette. Dirt can cause dropout, the most harmful effect in digital recording.

Mis-erasure Prevention Hole

* Preventing erasure of recordings.

If a recording is made on a prerecorded tape, the previous recording will be erased. DAT cassette tapes have a feature to prevent recording so as not to erase an important recording.

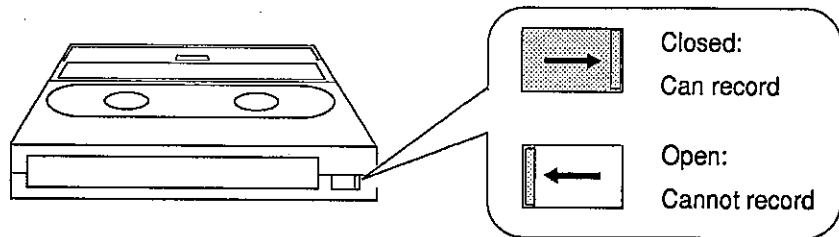

Notes on Handling

- * Dew may collect on the tape when it is brought into a warm room from a cold outdoors. Use the tape after leaving it in the room for about an hour. The tape will be damaged if used with moisture still collected on it.
- * Do not attempt to dry the cassette tape with a hair drier. Doing so will damage the tape.
- * Do not open the front lid of the cassette and pull out the tape or touch it with your fingers.
- * Be careful not to drop or hit or apply strong vibrations to the cassette.
- * The cassette cannot be used upside down.

Notes on Storage

- * Store the cassette in an enclosure to keep out dust and other foreign particles.
- * Do not place or store in the following locations:
 1. High temperature (35°C or higher) or high humidity (80% or higher).
 2. Near strong magnetism (near speakers and TV sets).
 3. Under direct sunlight.
- * Rewind the tape to the head of the winding after you are finished using it.

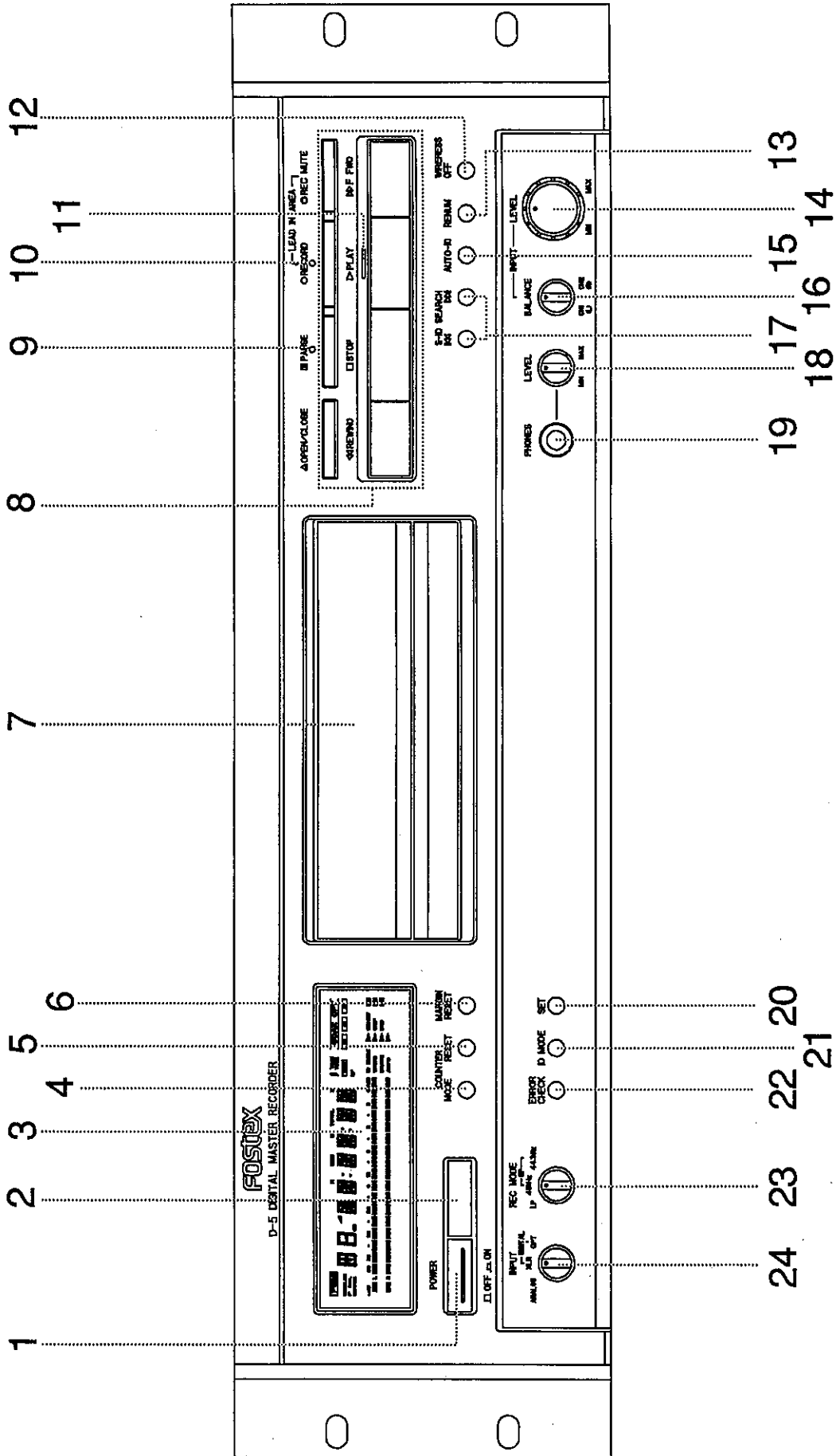

6. *Names and Functions of the Controls*

Letters in [] are actual panel letterings and this expression is used throughout this manual.

6-1. Front Panel Section

1. Power switch [POWER]

The power switch for this recorder.

Wait about four seconds after turning on the power before the recorder is ready for use.

2. Remote control light receiver

Receives light signal from the wireless remote controller.

3. Display

Input level and the recorder setup conditions are displayed here (Refer to pages 16 and 17).

4. Counter mode button [COUNTER MODE]

This is pressed to change the counter display (Refer to page 17).

5. Counter reset button [COUNTER RESET]

When this button is pressed after changing the counter mode to the elapsed time (TIME COUNTER) display, it will be reset to 0H:00M:00S (Refer to page 17).

6. Margin reset button [MARGIN RESET]

When this button is pressed, holding of the margin display will be reset. If this button is continuously pressed, the margin display will change to the real time display (Refer to page 25).

7. Cassette tray

The cassette tray is automatically slid in and out by the OPEN/CLOSE button.

8. Operating buttons

Open/close button [OPEN/CLOSE]

The cassette tray can be opened/closed by pressing this button. Used to load/unload the tape.

Stop button [STOP]

This is pressed to stop the tape or clear the program memory.

Rewind button [REWIND]

Used to rewind tape. Also, when pressed during playback, the tape can be cued in the REWIND direction (Refer to page 31).

Fast forward button [F FWD]

Used to fast forward the tape. Also, when pressed during playback, tape can be cued in the FORWARD direction (Refer to page 31).

Play button [PLAY]

Pressed to playback the tape.

Record button [RECORD]

The D-5 enters the recording mode (record standby mode) when pressed and the RECORD, PAUSE and PLAY indicators will light. To start recording, press either the PLAY or PAUSE button.

Pause button [PAUSE]

Used to momentarily stop tape travel during recording or playback. This is pressed again to restart. This button is not effective during fast forward or rewind.

Mute button [REC MUTE]

When this is pressed during recording, no-sound recording (REC-MUTE) will continue as long as this is pressed (Refer to pages 24 and 25).

9. Pause indicator [PAUSE]

Indicates that recorder is in the PAUSE mode.

10. Record indicator [RECORD]

Indicates that recorder is in the RECORD mode.

11. Play indicator [PLAY]

Indicates that recorder is in the PLAY mode.

12. Wireless off button [WIRELESS OFF]

This switches on/off the receiving function from the wireless remote controller (Refer to page 17). When this function is off, the remote controller will not control the recorder.

This function will be on immediately after the power is switch on.

13. Renumber button [RENUM]

This is used to record a continuous P-NO. and TOC (Table Of Contents) (Refer to page 42).

14. Input level knob [INPUT LEVEL]

This is for setting the recording level when recording analog audio signal (Refer to page 25).

This will not function during recording of digital signal inputs.

15. Auto ID button [AUTO-ID]

During recording	Used for automatic recording of S-ID and P-NO.
During playback	Used to skip unnecessary sections (jumping from SKIP-ID to next S-ID).

* Setup conditions prior to power switch off will be held in memory.

16. Input balance knob [INPUT BALANCE]

This is used to balance recording levels between 1ch (L) and 2ch (R) (Refer to page 25).

17. S-ID search button [S-ID SEARCH << >>]

This is used to search S-ID recorded on tape (Refer to page 33).

18. Headphone level knob [PHONES LEVEL]

For adjusting sound volume in the monitor headphones.

19. Headphone jack [PHONES]

A monitor headphone is plugged in here.

20. Set button [SET]

Used for sub code editing.

When this button is pressed, sub codes of the mode selected by the ID mode button can be record/erased (Refer to page 40 ~).

21. ID mode button [ID MODE]

Used for sub code editing.

The desired ID mode is selected by pressing this button (Refer to page 40 ~).

22. Error check button [ERROR CHECK]

The present error condition can be displayed by pressing this button (Refer to page 16).

* Setup conditions prior to power switch off will be held in memory.

23. Record mode switch [REC MODE]

The switch for setting sampling frequency at recording analog audio signals.

However, as an exception, when recording FS 32kHz DIGITAL IN signals in the SP or LP mode, the REC MODE switch setting must be changed. For details on this, refer to page 22.

LP	Set switch to this position for long play (LP) mode recording at 32kHz sampling frequency.
SP (48kHz)	Set switch to this position for standard (SP) mode recording at 48kHz sampling frequency. Recording at 48kHz sampling frequency is possible only for the standard (SP) mode.
SP (44.1kHz)	Set switch to this position for standard (SP) mode recording at 44.1kHz sampling frequency. Recording at 44.1kHz sampling frequency is possible only for the standard (SP) mode.

24. Input selector switch [ANALOG/XLR/OPT]

The switch for selecting the port to which the signal is input to this recorder.

ANALOG	To record from equipment connected to the ANALOG input connector.
XLR	To record from equipment connected to the XLR input connector.
OPT	To record from equipment connected to the OPTICAL input connector.

6-2. Display Section

RENUM Indicates renumbering is in operation.
P-NO. Indicates the program number.
 If the tune number information is recorded on tape:

P-NO. **00** ← tune number is displayed.

When it arrives at the end ID by fast forward winding:

P-NO. **EE** ← EE is displayed.

MARG Indicates the margin.

If the input level overshoots:

MARG **00** dB ← 00dB will blink.

LP Indicates long play mode.

COAX Indicates that XLR digital input has been selected by the input selector switch.

OPT Indicates that OPTICAL digital input has been selected by the input selector switch.

32, 44, 48 Indicates the present sampling frequency. Should the signal of the digital input be interrupted during recording, the sampling frequency display will blink.

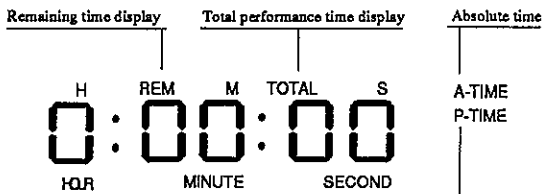
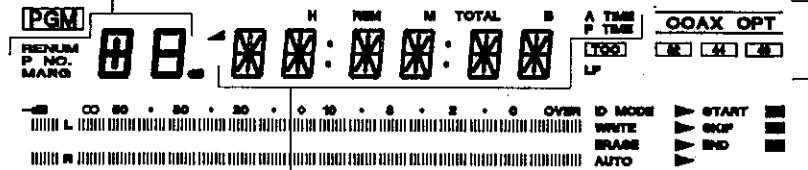

*** A-TIME (Absolute time)**
 Displays elapsed time (absolute time) from the start of the tape winding.

P-TIME (Program time)
 Displays the elapsed time of each tune (or one tune).

*** REMAIN (Remaining time)**
 Displays remaining time of tape.

*** A-REMAIN (Remaining playback time)**
 Displays the time from present position up to END-ID (Remaining playback time).

P-REMAIN (Remaining time of one tune)
 Displays the remaining performance time (The time up to the start point of the next tune) of present tune.

*** TIME COUNTER (Elapsed time)**
 Displays elapsed time from the counter reset point.

*** TOTAL (Total performance time)**
 Displays total performance time of the recorded program.

(*) The time information displayed with this symbol will differ from the actual time depending on the recording mode. The display is based on the standard mode (SP).
 For the long play mode (LP), convert the display time by multiplying it 2 times.

* When absolute time (A-TIME) information is recorded on the tape.



* The display will be a bar if A-TIME is not recorded. For virgin tape or if nothing is recorded on the tape, the display will be as shown below:

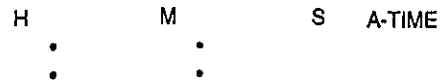

* When the WIRELESS OFF button is switched ON/OFF:
 When the WIRELESS OFF button is switched ON, the "WIRELESS ON" display will flow from right end of the display to the left. When it is switched OFF, the "WIRELESS OFF" display will flow in the same way.

* When the ERROR CHECK button is pressed:
 The present error condition will be display as shown below:



Error condition of A-ch and B-ch will be displayed in 10 steps from 0 through 9.

<NOTE>

Multiplying the displayed number by 10⁻¹ will give the approximate error rate figure.

Indicates that a tune number is assigned.

Indicates that TOC is read from the tape.
This will blink during write-in or read-in of TOC.

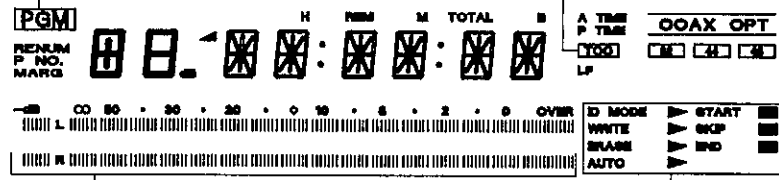

Peak figures of the input level during recording or peak figures of the playback level during tape playback will be displayed.

OVER ... This will light when input level overshoots. In this condition, the margin display will blink at 00dB (at analog recording).

ID-MODE Displays type of ID mode.
> Displays selected ID mode.
■ Indicates that ID has been detected.
WRITE Indicates that it is in the ID record mode.
ERASE Indicates that it is in the ID erase mode.
AUTO At recording, this indicates that AUTO-ID is ON. During playback, this indicates that SKIP PLAY is ON.

How to Change The Counter Display

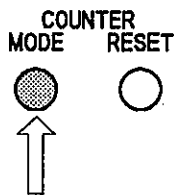

The counter display will change as follows with each press of the COUNTER RESET button.

→ When reading TOC
 When not reading TOC

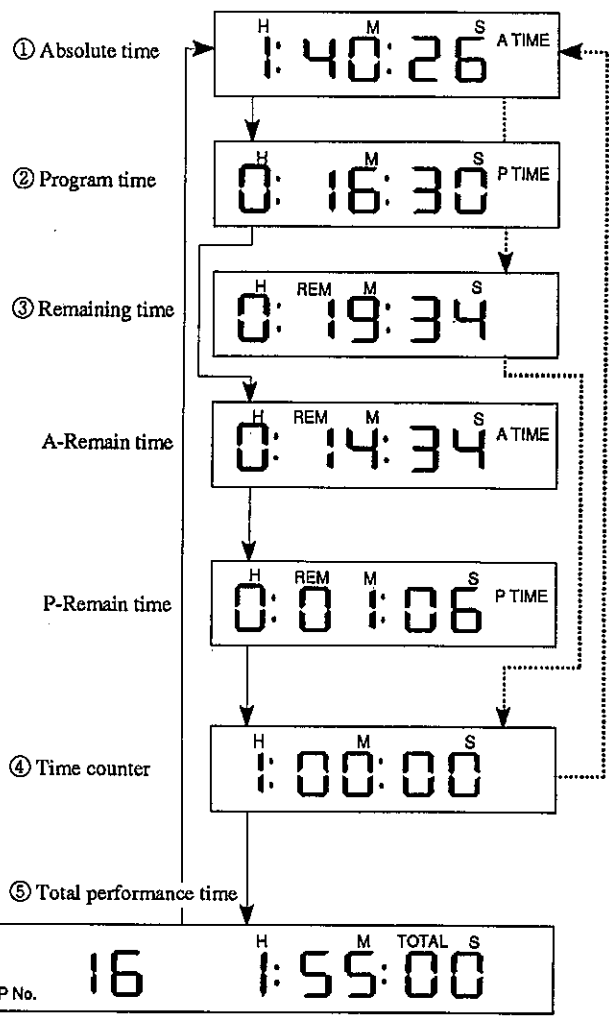

To Return to "0" Second (reset)

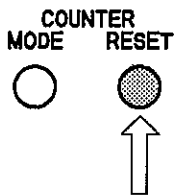

Press the reset button while in the elapsed time (TIME COUNTER) mode.

<NOTE>

During playback when TOC (Refer to page 44 ~) is being read and when recording from an intermediate point of the tape, A-REMAIN, P-REMAIN and TOTAL will not be displayed.

Remember, REMAIN and TIME COUNTER are not a clock. Use them only for a quick reference.

(Total number of tunes will also be displayed)

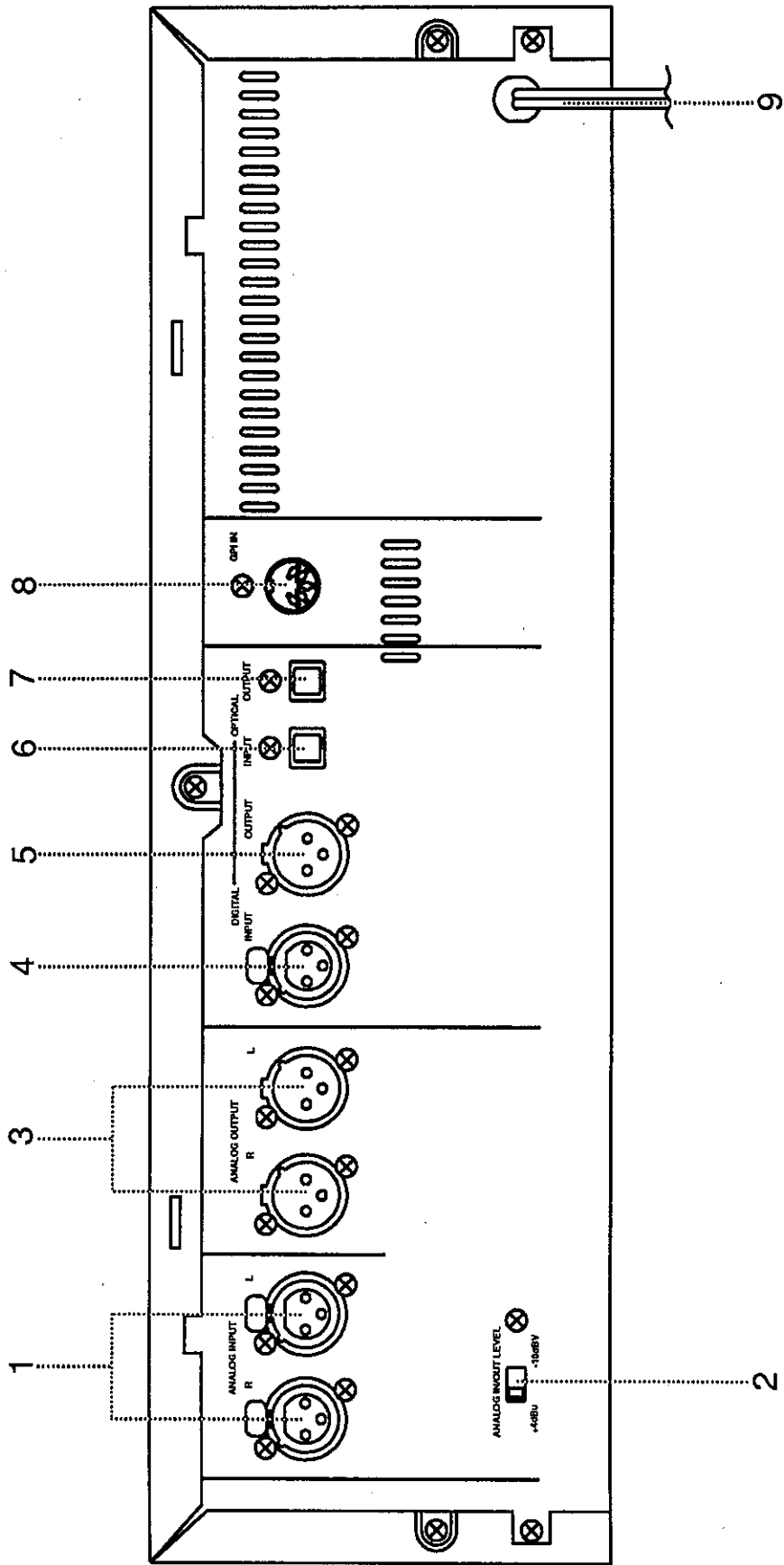

6-3. Rear Panel Section

1. Analog input connectors [ANALOG INPUT L, R]

Analog audio signals (L, R) are input here.

Connector: XLR-3-31 (Pin 1: GND, Pin 2: HOT, Pin 3: COLD)

2. Analog input and output levels selector switch [ANALOG IN/OUT LEVEL]

Input and output levels of analog audio signals can be selected by this switch. The input and output levels can be selected for +4dBu or -10dBV.

3. Analog output connectors [ANALOG OUTPUT L, R]

Analog audio signals (L, R) are output here.

Connector: XLR-3-32 (Pin 1: GND, Pin 2: HOT, Pin 3: COLD)

4. Digital input connector [DIGITAL INPUT]

AES/EBU format digital audio signals are input here.

Connector: XLR-3-31 (Pin 1: GND, Pin 2: HOT, Pin 3: COLD)

5. Digital output connector [DIGITAL OUTPUT]

AES/EBU format digital audio signals are output here.

Connector: XLR-3-32 (Pin 1: GND, Pin 2: HOT, Pin 3: COLD)

6. Digital input connector [OPTICAL INPUT]

Consumer optical format digital audio signals are input here. Connector: Optical connector

7. Digital output connector [OPTICAL OUTPUT]

Consumer optical format digital audio signals are output here. Connector: Optical connector

8. GPI input connector [GPI IN]

External commands are input here. Connector: DIN 5 PIN

Pin assignment of GPI connector:

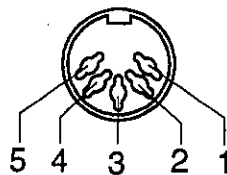

1	GND
2	STOP
3	PLAY
4	S-ID SEARCH (>>)
5	S-ID SEARCH (<<)

STOP command input (No. 2 pin)

The same function as the STOP button is obtained by input of this  pulse.

PLAY command input (No. 3 pin)

The same function as the PLAY button is obtained by input of this  pulse.

S-ID SEARCH (>>) command input (No. 4 pin)

The same function as the S-ID SEARCH (>>) button is obtained by input of this  pulse.

S-ID SEARCH (<<) command input (No. 5 pin)

The same function as the S-ID SEARCH (<<) button is obtained by input of this  pulse.

<NOTE>

The input level of the command signal is TTL level, LOW ACTIVE. Therefore, do not use with anything other than the TTL level as this will result in malfunction and possibly cause breakdown.

9. Power cable

6-4. Wireless Remote Controller

Buttons on this controller with the same names as on the recorder will function in the same way.

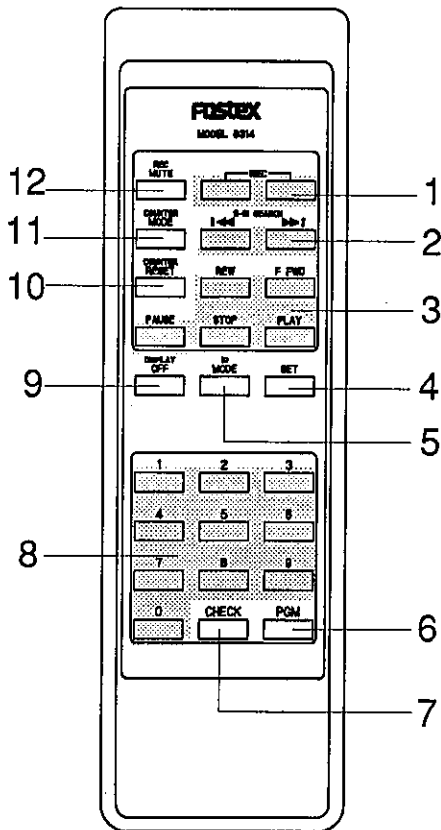

1. Record key [REC]

The two buttons are pressed simultaneously.

2. S-ID search key [S-ID SEARCH]

3. Tape transport keys

- * Fast forward key [F FWD]
- * Rewind key [REW]
- * Play key [PLAY]
- * Stop key [STOP]
- * Pause key [PAUSE]

4. Set key [SET]

5. ID mode key [ID MODE]

6. Program key [PGM]

7. Check key [CHECK]

8. Numerical keys [0 ~ 9]

9. Display off key [DISPLAY OFF]

10. Counter reset key [COUNTER RESET]

11. Counter mode key [COUNTER MODE]

12. Record Mute key [REC MUTE]

Effective Range of the Remote Controller

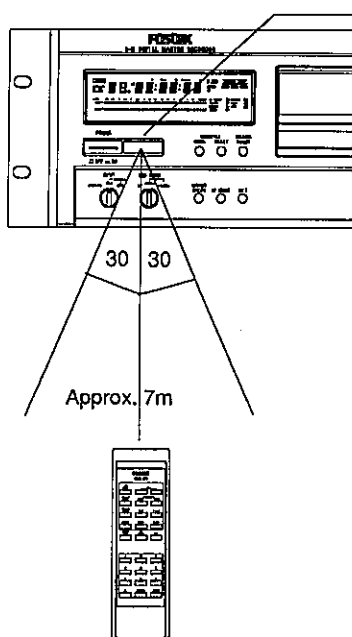

Remote Controller Optical Receiver Element

Aim the remote controller here and press the button.

<Notes on Using the Controller>

- * The remote controller will be ineffective if there is any obstructing object between it and the recorder or if the controller angle with the optical receiver element is too large.
- * The recorder may malfunction if direct sun light or any strong light from a fluorescent lamp shines on the optical receiver element.
- * The tape deck could malfunction if it is used in proximity of equipment emitting infrared light or other remote controllers employing infrared light are used together with this controller. Also, if this remote controller is used in proximity of other infrared controlled equipment, that equipment could also malfunction.
- * If the operational range or distance of the remote controller become drastically small, replace its battery.
- * Remove the battery from the controller if it is not to be used for long periods (more than one month) to prevent damage from leaking battery electrolyte.

7. Basic Recording Process

Recording mode (for analog inputs)

In the D-5, the REC MODE switch is selected as follows depending on type of analog signal that is input for recording (Recording is not possible in settings other than in this list).

REC MODE switch	SP (48kHz)	SP (44.1kHz)	LP
Analog signal (32kHz)			Long play
Analog signal (48kHz)	Standard		
Analog signal (44.1kHz)		Standard	

Recording mode (for digital inputs)

For FS 48kHz or 44.1kHz digital input, if the INPUT select switch is set to DIGITAL (XLR or OPT), recording will be in the standard (SP) mode as shown below regardless to setting of the REC MODE switch.

Input signal	Recording mode
(*) Digital signal (32kHz)	Either long play (LP) recording is possible by setting the REC MODE switch accordingly.
Digital signal (48kHz)	It will automatically be standard (SP) recording at 48kHz.
Digital signal (44.1kHz)	It will automatically be standard (SP) recording at 44.1kHz.

(*) For standard (SP) recording of FS 32kHz signal, although the REC MODE switch may be set at SP (48kHz) or SP (44.1kHz), it will be standard digital recording at 32kHz.

7-1. Recording Analog Audio Signals

7-1-1. Connecting Method

Make connections as in the following schematic for recording analog audio signals. Input level of the D-5 can be switched to match the output level of the equipment that is connected to it. Set the LEVEL switch to +4dBu or -10dBV.

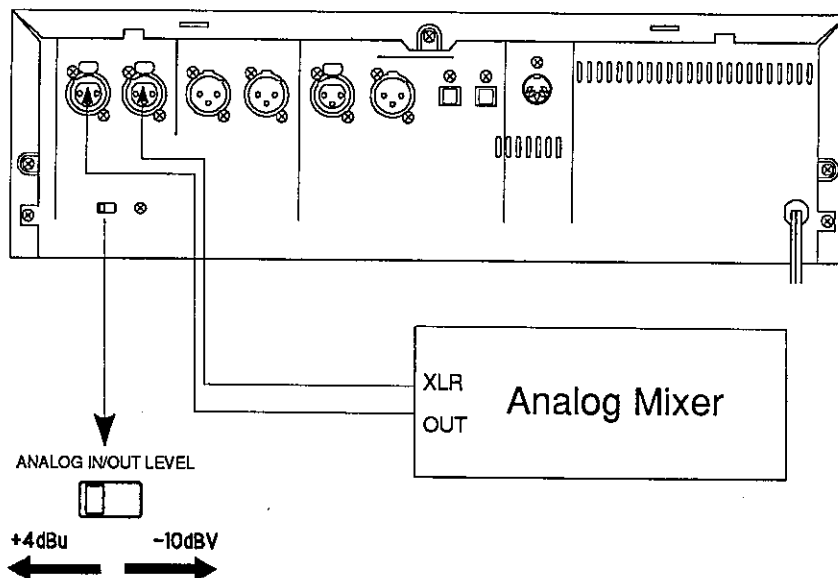

7-1-2. Preparation for Recording

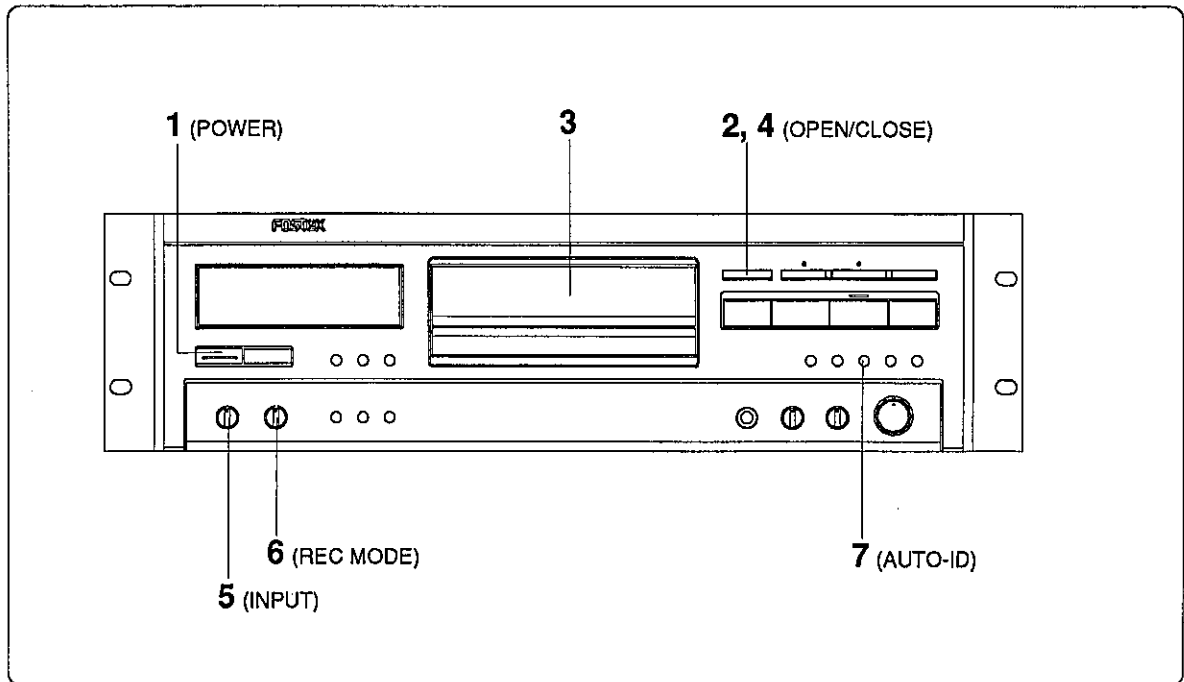

1. Switch on the power.
2. Press the OPEN/CLOSE button to open the cassette tray.
The cassette tray will slide out.
3. Load a cassette.
Gently place the cassette on the tray with the side in which tape can be seen facing upward.
4. Press the OPEN/CLOSE button again to close the cassette tray.
The tray will also close when either the PLAY, STOP, REWIND or F FWD button is pressed.
It will also close automatically if the cassette tray is lightly pushed.
5. Set the INPUT selector switch to "ANALOG."
6. Select recording mode with the REC MODE switch.
In the D-5, select the following recording mode with the REC MODE switch according to type of input signal (Recording is not possible in settings other than in this list).

REC MODE switch	SP (48kHz)	SP (44.1kHz)	LP
Input signal			
FS 32kHz analog signal			Long play
FS 48kHz analog signal	Standard		
FS 44.1kHz analog signal		Standard	

7. Select whether P-NO. should be recorded automatically or manually.
Automatic recording of P-NO.:
Switch ON the AUTO-ID button. ("AUTO" will light).
Manual recording of P-NO.:
Switch OFF the AUTO-ID button. ("AUTO" will extinguish).

* Refer to "Sub code editing" on P-NO. recording method.

7-1-3. To Record from Start of Tape

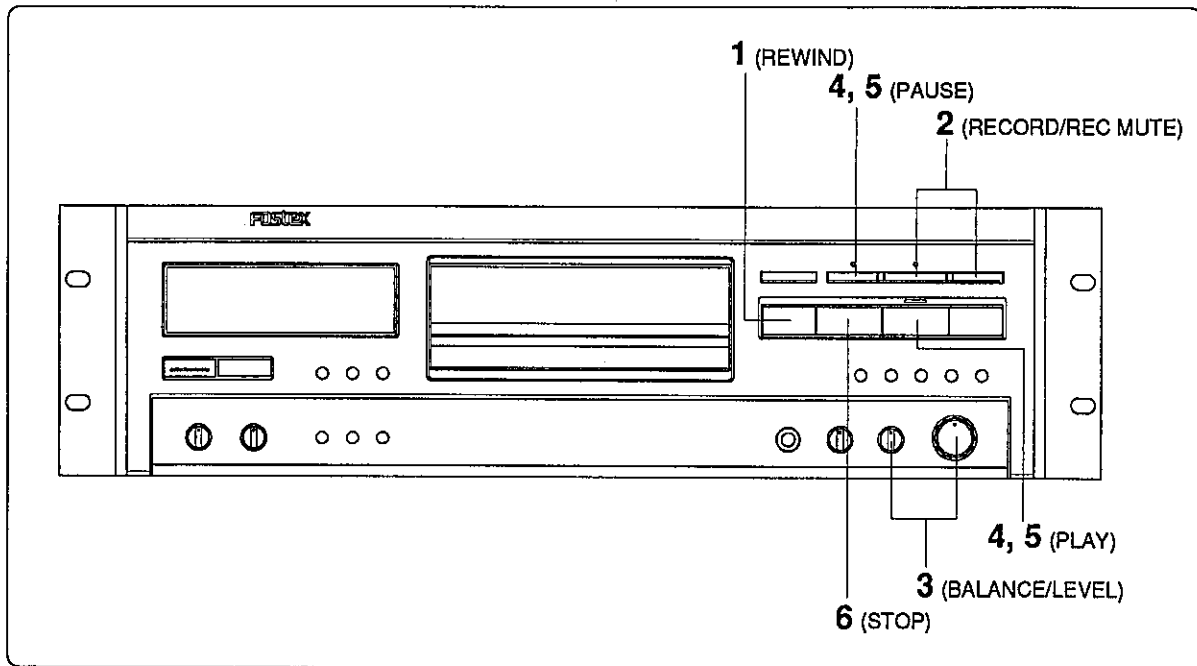

1. Press the REWIND button and rewind the tape.
Always rewind tape when recording A-TIME (absolute time) on the tape.
2. Press RECORD button while pressing down on the REC MUTE button.
RECORD indicator will blink and after making no recording section (lead-in area), it will enter the record standby mode.

Lead-in area:

The section established at the head of tape for correct record and playback of time information and others, and in the D-5, this is recorded by the initialization operation. When this area is played back, P-NO. will be displayed as "bb" and A-TIME will be indicated with the minus symbol.

3. Start the source music to be recorded and adjust the recording level.
(Refer to next page for details on adjusting)
Upon completing level adjusting, return the source music to its start point.
4. Start recording by pressing the PLAY or PAUSE button and start the source to be recorded.
5. To interrupt recording, press the PAUSE button.
To resume recording, either press the PLAY or PAUSE button.

<NOTE>

To protect the tape, the transport will enter the stop mode should more than 5 minutes elapse while in the record standby mode (the monitor sound will continue to be output). In this state, the only RECORD will be lit. To resume recording, enter the record standby mode by pressing the RECORD button and then proceed to the next operation.

6. Press the STOP button to finish recording.
For recording an END-ID at the record finish point, please refer to "Editing the sub code."

How to Make a No Recorded Section on Tape (How to use the REC MUTE button)

- * When the REC MUTE button is pressed while recording, the RECORD indicator will blink, enter the no recording mode for about 4 seconds and then enter the record standby mode.
- * If more than 4 seconds of no recording section is to be made, continue pressing the REC MUTE button. The RECORD indicator will continue blinking after elapse of more than 4 seconds, then enter the record standby mode upon releasing the REC MUTE button.
- * To resume recording, press the PLAY button.

Setting the Recording Level (For analog input only)

Rough Adjusting

When recording analog input, adjust the INPUT LEVEL knob so that the recording level does not overshoot 0dB when the largest peak signal is input.

When the maximum permissible input is exceeded, the "OVER" section will light and MARGIN indicator will blink. In such a case, lower the level by gradually rotating CCW the INPUT LEVEL knob and reset the MARGIN display by pressing the MARGIN RESET button.

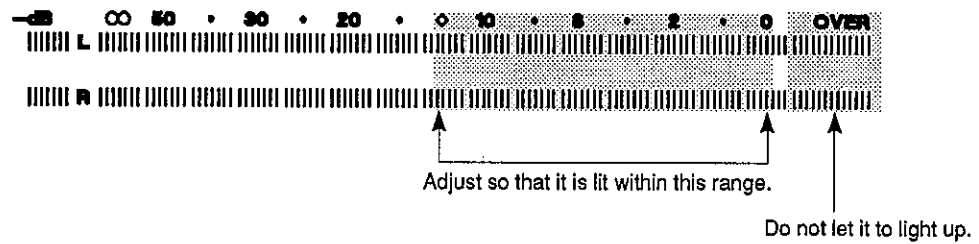

The MARGIN Display

The MARGIN display will show in dB units how much input level margin exists up to the maximum permissible input level.

MARG 00 dB

MARGIN
RESET



The MARGIN display will continue to show the maximum level.

The MARGIN will be reset when the MARGIN RESET button is pressed once. If this button is continuously pressed, it will display the MARGIN in real time.

Recording Balance

Depending on the source to be recorded or the equipment used for playback, in some cases the left and right sound volume will not be in balance (sound will not be positioned in center when listened in monaural).

In such a case, the level of CH 1 (L) or CH 2 (R) is adjusted by the INPUT BALANCE knob.

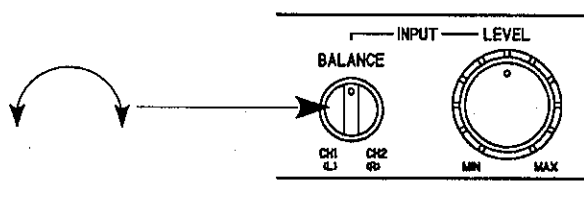

7-1-4. Recording from Intermediate Point of Tape

The method of subsequent recording on a prerecorded tape is explained here.

To add recorded information to a prerecorded tape, the end point of the previous recording must be found and the tape located there.

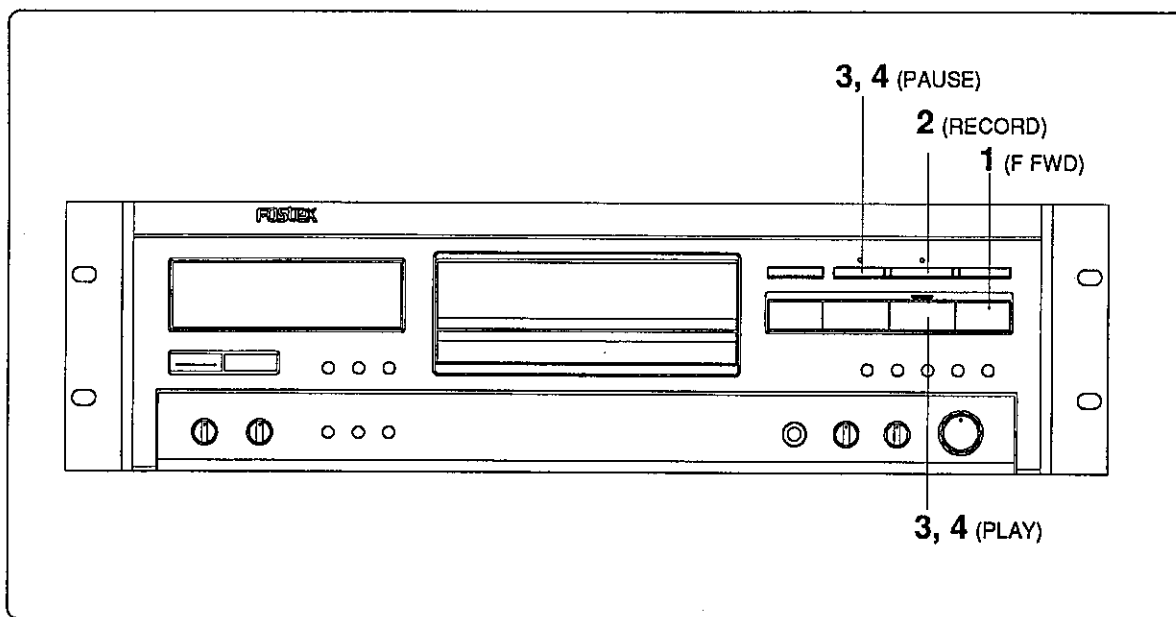

1. Press the F FWD button to advance the tape to the end point of the previous recording. (End search function)

When the F FWD button is pressed, the END-ID will be searched and the tape stopped there. If there is no END-ID, the end point of the recording will be detected and the tape stopped there.

2. Press the RECORD button to enter the record standby mode.
While in the record standby mode, adjust the recording level.
3. After adjusting the recording level, start recording by pressing the PLAY or PAUSE button.
4. To interrupt recording, press the PAUSE button.
To resume recording, press the PLAY or PAUSE button.

<NOTE>

After an elapse of about five minutes in the record standby mode, the transport will enter the stop mode to protect the tape (the monitor sound, however, will be output). In this condition, the only the RECORD will be lit. To resume recording, press the RECORD button to enter the record standby mode, and then proceed to the next operation.

5. Press the STOP button to end recording.

Refer to "Sub code editing" for the procedure in recording an END-ID at the end point of recording or to erase the END-ID when it is not needed.

<NOTES>

- * If the END-ID is recorded on the tape, a P-NO. will be automatically set after completing end search.
- * It will also be automatically set even though a P-NO. is on display after playback.
- * If the P-NO. display is "--", a P-NO. is required although it is recording with AUTO-ID on. If nothing is assigned, recording will start from P-NO. "01."
- * Refer to "Sub code editing" for details.

7-2. Recording Digital Audio Signals

7-2-1. Connections

Make connections as follows for digital audio signal recording.

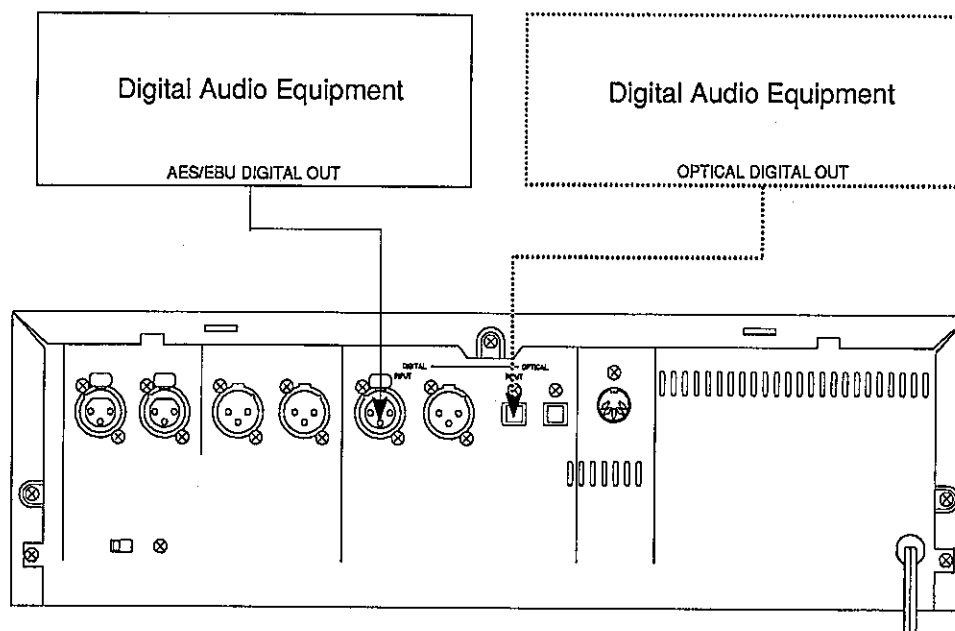

Notes on Handling Optical Cables

- * Do not bend the optical cables sharply. Doing so could damage the cable. When winding the cables for storage, the winding diameter must be larger than 15cm.
- * In making connections, the cable must be firmly inserted to avoid improper connections.
- * Use optical cables no longer than 3 meters.
- * Be careful not to scratch or allow dust to collect on the optical cable plugs. If they are dirty, wipe them off with a soft cloth before connecting.
- * To protect dust from collecting in the optical connectors (OPTICAL) of the D-5 when optical cables are not plugged in, be sure to cover them with dust protection caps.

7-2-2. Preparation for Recording

Preparations are basically the same as for "Recording of analog audio signals" but the following must be noted for digital audio signals.

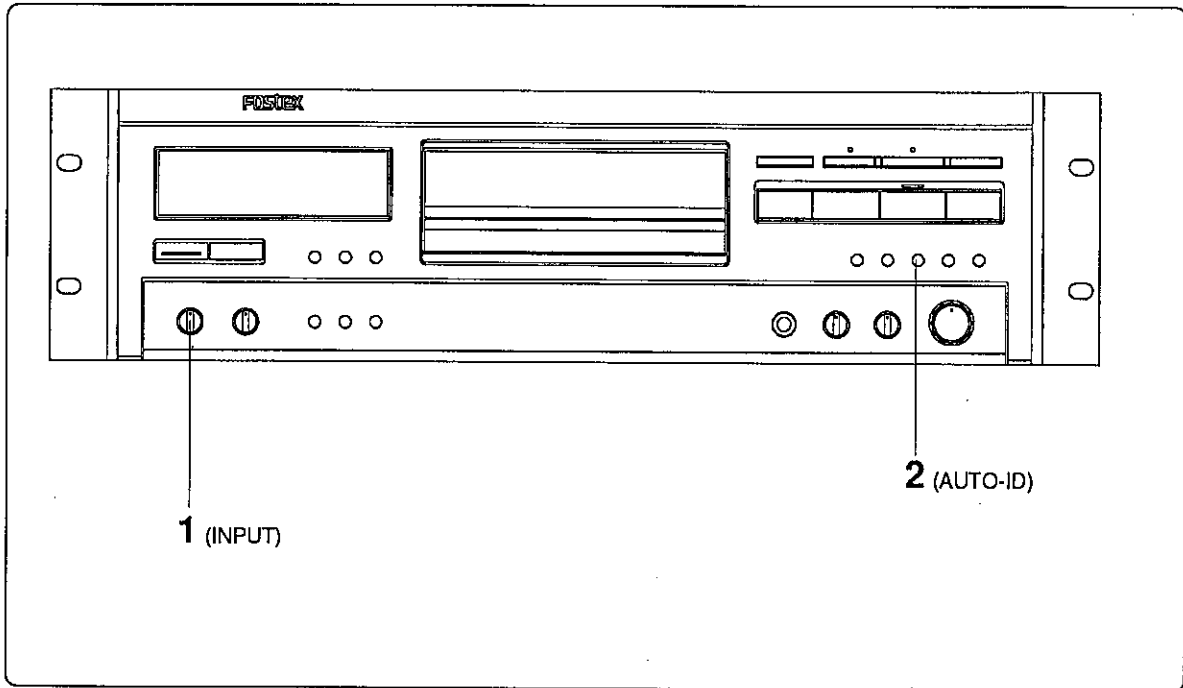

1. Select XLR or OPT by the INPUT selector switch.

Check the digital input cable connection and switch the selector accordingly.

If "XLR" is selected:	"COAX" will be lit.
If "OPT" is selected:	"OPT" will be lit.

In the D-5, if the digital input FS is 48kHz or 44.1kHz, it will record automatically in the following modes regardless to the REC MODE switch setting.

However, if an FS 32kHz digital input is to be recorded, select the SP or LP mode with the REC MODE switch.

Input signal	Recording mode
(*) FS 32kHz digital signal	Recording in long play (LP) set by the REC MODE switch.
FS 48kHz digital signal	Automatic recording of FS 48kHz signals in standard play (SP).
FS 44.1kHz digital signal	Automatic recording of FS 44.1kHz signals in standard play (SP).

(*) For standard play (SP) recording of FS 32kHz, whether the REC MODE switch is set to SP (48kHz) or SP (44.1kHz), the recording mode will be standard digital recording of 32kHz signals.

2. Select whether P-NO. is to be recorded automatically or manually.

When automatic recording of a P-NO.:

Switch ON the AUTO-ID button (AUTO will be lit).

At manual recording of P-NO.:

Switch OFF the AUTO-ID button (AUTO will be extinguished).

* Refer to "Sub code editing" for recording method of P-NO.

7-2-3. Recording Procedure (Digital Input)

Follow the same procedures for "Analog audio signal recording" to record from start of tape or even from an intermediate point on the tape.

However, the recording level need not be adjusted when recording digital audio signals.

The Display When Digital Input is Interrupted

If nothing is connected or the connection to the digital input is broken, or if input of the digital signal fails for some reason, the "Fs" display (32, 44, 48) will blink.

This is an indication that input has been interrupted. Should this display appear during digital recording, the PAUSE indicator will blink and enter in the record standby mode. It will standby until the input is resumed but if more than about 5 minutes elapses in the interrupted state, the recording mode is canceled and the D-5 will revert to the stop mode.

8. Playback Procedure

8-1. Connections

When connecting to the ANALOG OUTPUT connectors, the output level of the D-5 can be switched to match the input level of the equipment connected to it. Set the LEVEL switch to +4dBu or -10dBV.

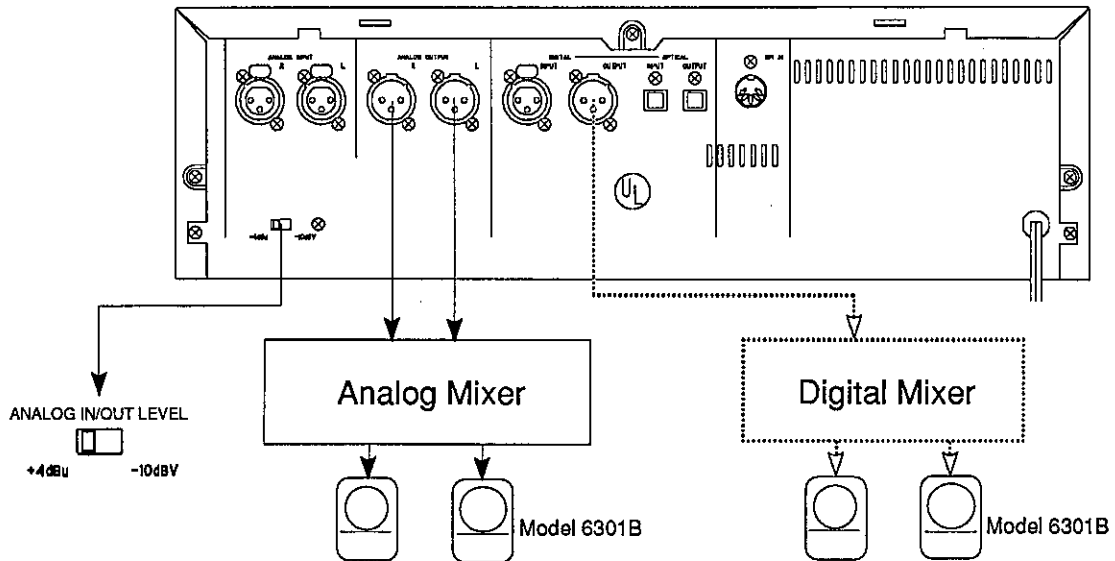

8-2. Preparation to Playback

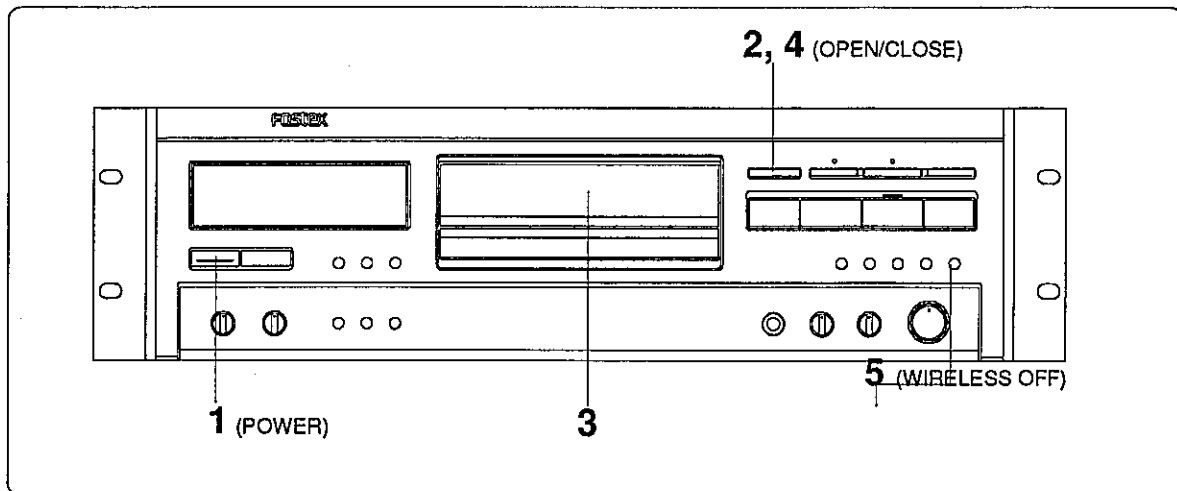

1. Switch on power.
2. Open the cassette tray by pressing the OPEN/CLOSE button.
The cassette tray will slide out.
3. Load a cassette in the tray.
Gently place a cassette on the tray with the side through which tape can be seen facing upward.
4. Close the cassette tray by pressing the OPEN/CLOSE button again.
The tray will also close automatically if the PLAY, STOP, F FWD or REWIND button is pressed.
It will also close automatically if the tray is lightly pushed in.
5. Press the WIRELESS OFF button to switch ON the wireless remote controller function.
Check that "WIRELESS ON" travels across the display.

8-3. Basic Playback Procedures

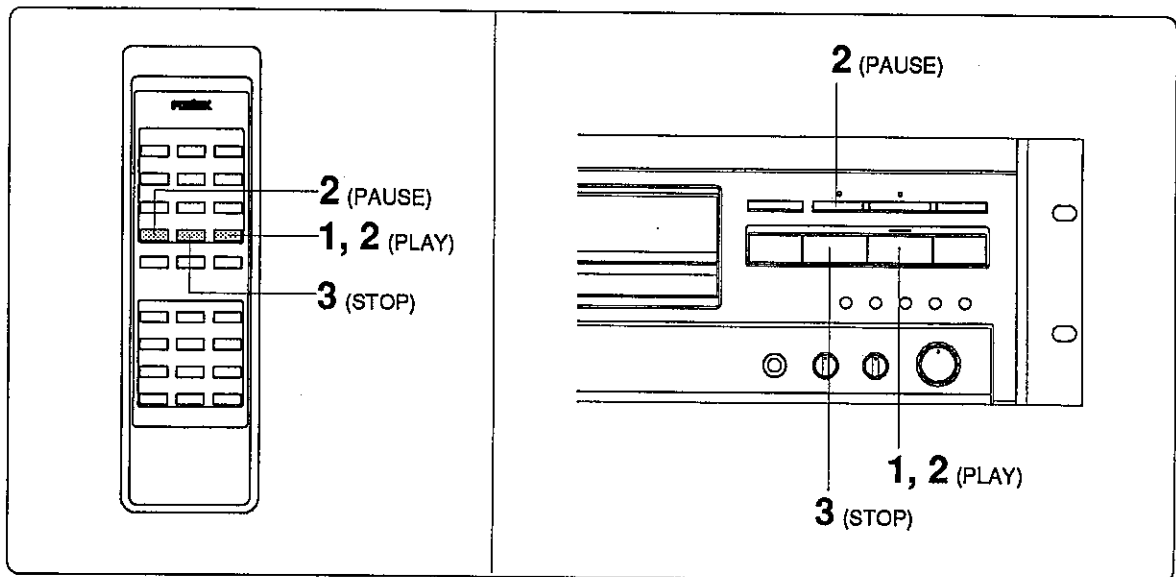

1. Press the PLAY button.
2. Press the PAUSE button to momentarily stop the playback.

Press the PLAY button again to resume playback.

If about 5 minutes elapses in the pause state, it will automatically enter the playback mode to protect the tape.

3. To end the playback, press the STOP button.

Rewind and Fast Forward Functions

The tape will rewind or fast forward if the REWIND button or F FWD button is pressed while the transport is stopped. If the F FWD or REWIND button is pressed twice, winding speed will decrease and if pressed again, the D-5 will return to its original speed.

Automatic Rewind Function

When the tape is completely wound in the FORWARD direction, it will automatically rewind to the head of the tape.

Finding The Desired Tune

CUE function during playback

CUE in the playback mode can be entered by pressing the REWIND or F FWD button. If pressed once, CUE will playback at 3 times speed (6 times for LP).

If pressed continuously, CUE will playback at 5 times speed (10 times for LP). The D-5 will return to original speed (3 times) when this button is released. It will return to normal playback when PLAY is pressed.

FINE CUE function during performance pause (PAUSE)

FINE CUE can be entered by pressing the REWIND or F FWD button while in the performance pause mode. If these buttons are continuously pressed while in the performance pause mode, playback will be at 0.5 times speed. If the buttons are released, the D-5 will return again to the performance pause mode.

In the LP mode, the D-5 will be in the playback speed (1 time) for each mode. The sound of CUE and FINE CUE will deteriorate compared to normal playback.

8-4. Various Playback Methods

8-4-1. P-NO. Locating Method

Direct music selection is possible in the STOP, playback or pause modes.

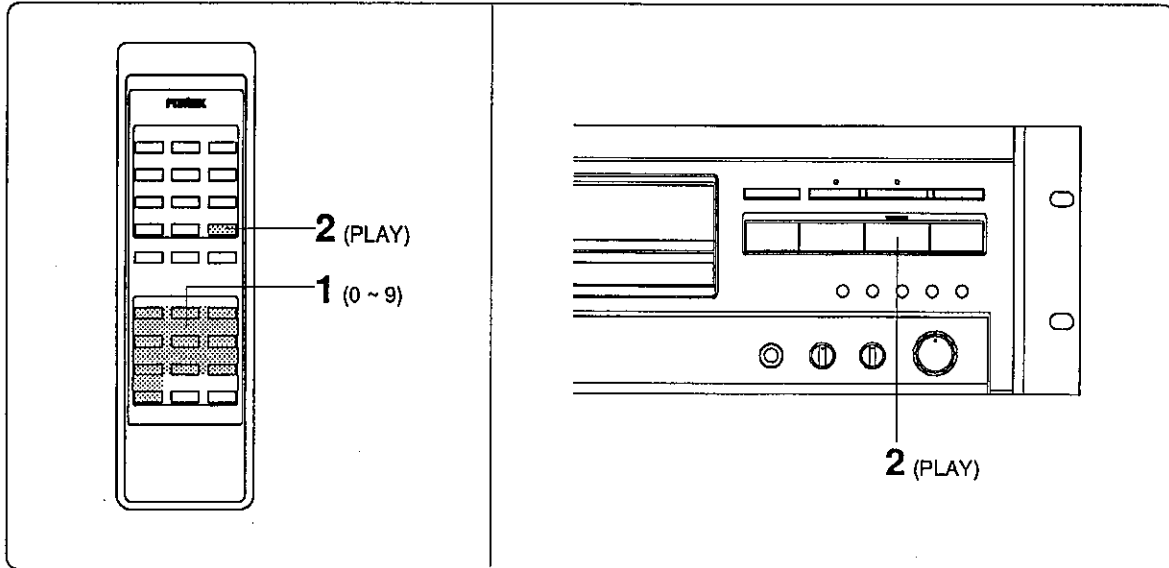

1. Select the desired P-NO.

Select and press the desired number (P-NO.) from the remote controller.

2. Press the PLAY button.

Music selected during playback or in the pause mode will be canceled if the PLAY button is not pressed within 4 seconds.

Press the STOP button to end playback.

Music selected during pause will return to pause upon completing search.

Tape not correctly recorded with a P-NO. will not operate correctly even if a P-NO. is specified.

If the tape is rerecorded or an S-ID is added/erased, carry out "Renumber" (Page 42) by which P-NO. will correctly rerecord.

High Speed AI Search

After TOC information is read ("Reading and display of TOC data", page 43 ~), about 20 seconds of tape played back and internal operation is completed, the search speed will be about 300 times and AI search will then be possible (Up to P-NO. 50).

Also in the D-5, when P-NO. recorded on tape is read, that point will be learned and thereafter be able to AI search (Up to tune number 50).

Normal search speed is about 200 times. The PLAY indicator blinking will be faster during AI search.

<NOTES>

* Time will not be displayed during high speed AI search (Display will be "- : - : - A TIME").

* High speed AI search will not function if the AUTO-ID button is switched off.

8-4-2. S-ID Search

S-ID search is functional in the STOP, PLAY or PAUSE modes.

After completing search, it will automatically enter the PLAY mode. However, only when an S-ID search is done from PAUSE will the D-5 return to PAUSE after completing search.

This function operates by searching the S-IDs recorded on the tape. It will not operate correctly if an S-ID is located at an unnecessary point or if it is missing.

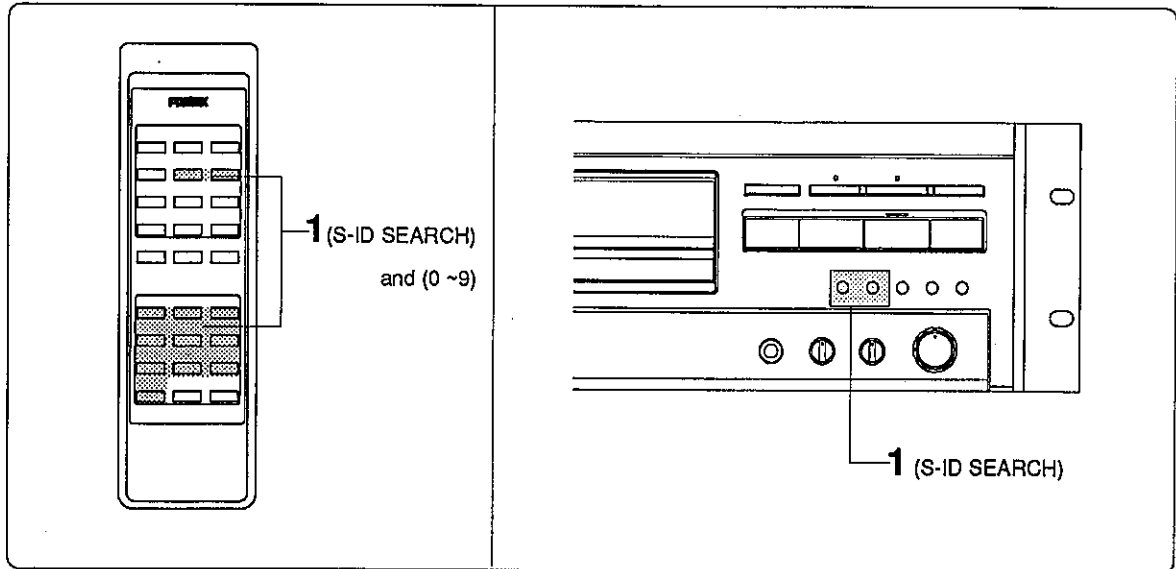

To listen again to the present tune

1. Press the S-ID SEARCH (<<) button once. Or, press the remote controller S-ID SEARCH (<<) key once.

*For example, for a tune three numbers back, the S-ID SEARCH (<<) button is pressed four times (number of tunes back +1, display will be -4).

*If the remote controller is used, press the numerical "4" then, press the S-ID SEARCH (<<) button.

To listen to the next tune

1. Press the S-ID SEARCH (>>) button once. Or, press the remote controller S-ID SEARCH (>>) key once.

*For example, if the S-ID SEARCH (>>) button is pressed three times (Display will be +3) for the tune three numbers ahead.

*If the remote controller is used, press the numerical key "3" then, press the S-ID SEARCH (>>) key.

Counting the Number of Tunes

If skip selection is to be done from midway of a tune, the recorder will return to the head of the present playback tune if "One tune back" is specified. If it is to be returned more than this, add "1" to the number counted.

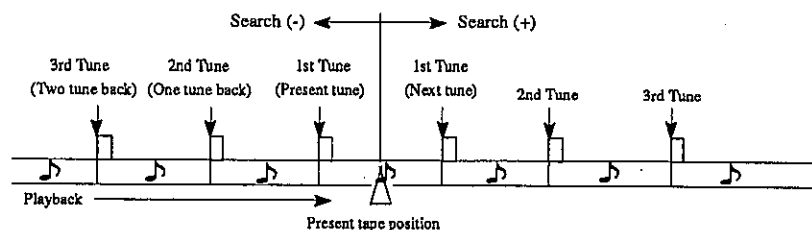

8-4-3. Skip Play

Skip play is the function of skipping the present tune and selecting the next tune for playback. This function becomes possible by recording an SKIP-ID where the undesired tune is located (the point which is to be skipped). Refer to "Sub code editing" on recording SKIP-ID.

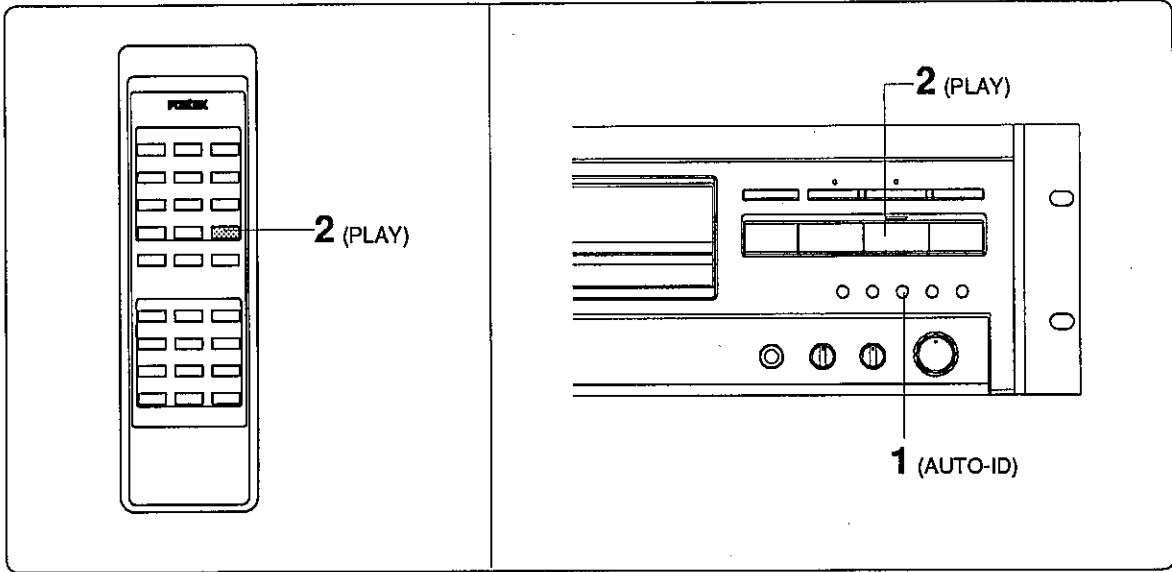

1. Switch ON the AUTO-ID button.

"AUTO" will be lit.

2. Press the PLAY button.

Switch off the AUTO-ID button if the skip function is not desired.

The Skip Play Function

In the D-5, when a SKIP-ID (mark for skipping) is detected during playback, the tape is fast wound to the next S-ID (mark indicating start of tune) and playback started from this point.

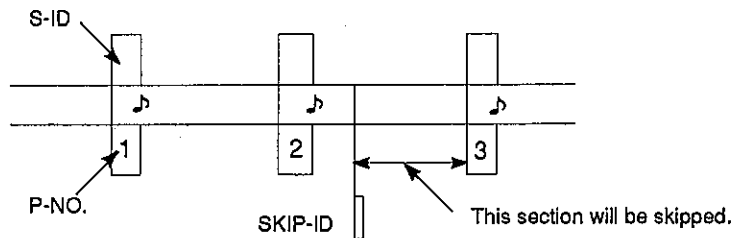

<NOTE>

As shown below, if there are unrecorded (unused) section before and after a short tune, if S-ID and P-NO. are searched from that point, they cannot be detected and so could fail to set tape at head of the tune. When recording, be careful not to make unrecorded sections between tunes. To make any length of unrecorded sections, use the REC MUTE button while in the record mode.

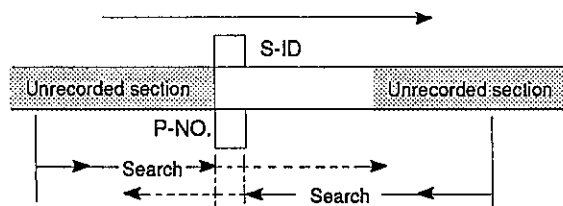

8-4-4. Listening to Desired Tunes Only (Program Playback)

This function is used to select favorite tunes only and play them in the desired sequence.

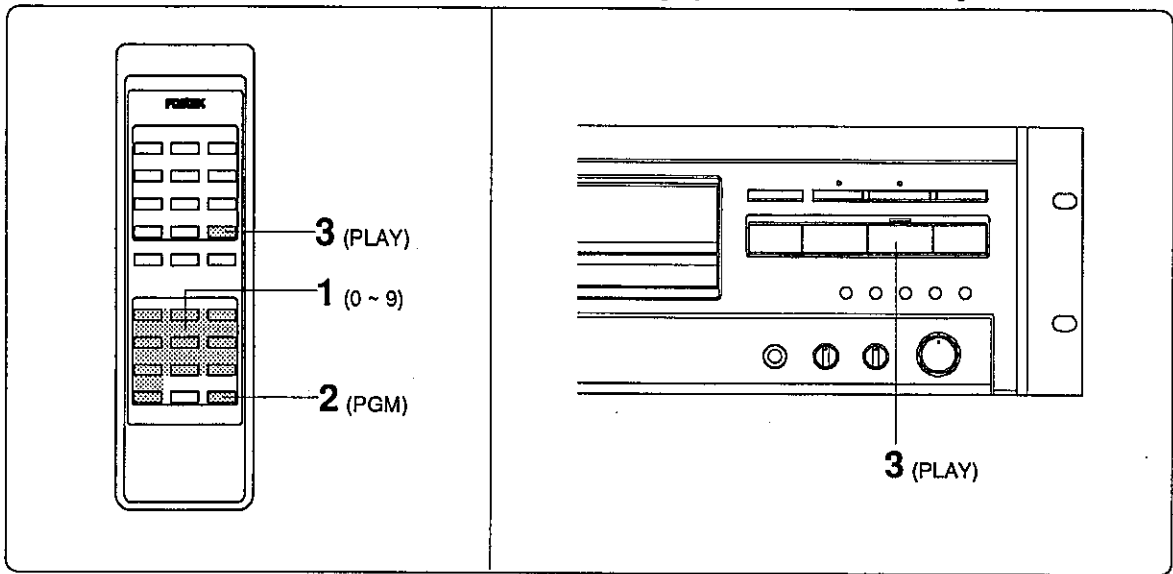

P-NO. Reservation

Carry this out in the STOP mode.

1. Select desired P-NO.

Select and press the desired number from the remote controller numerical key.

2. Press the remote controller PGM button.

Example: To reserve P-NO. 2 and 5:

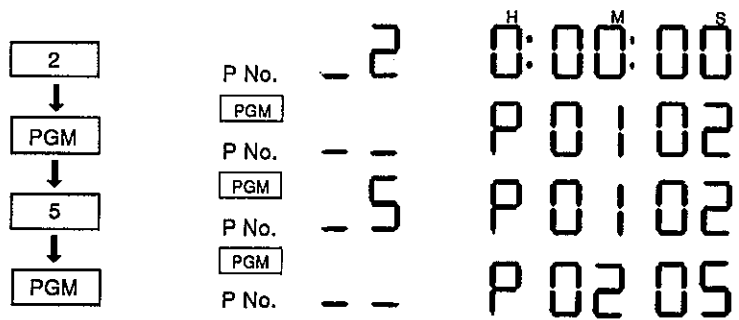

*Above steps 1 and 2 constitute reservation of one tune (one step).

*Up to 30 steps can be reserved by repeating above steps 1 and 2.

3. Press the PLAY button (or remote controller PLAY key).

Program playback will be started.

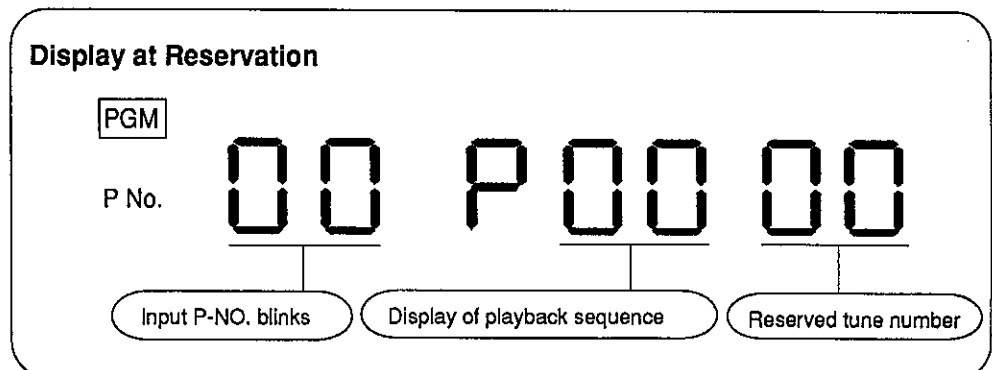

Skip Playback of Reserved Tune

- * By pressing the S-ID SEARCH button, steps can be moved forward and backward in one step increments.

Confirmation of Reserved Programs

- * Press the CHECK button while in the P-NO. reserved state. With each press of this button, the reserved P-NO. and step will be displayed one by one.
- * After displaying the last step, the reserved tune number display will change to "EE" when the CHECK button is pressed again.

Display of reserved program confirmation

05 P 02
Reserved tune number Display of playback sequence

When CHECK button is pressed at display of last step

EE P 05
Unused indicates Display of next number on last step

Program Playback Start from a Random Step

- * When the PLAY button is pressed from the reserved program confirmation mode, search and playback is started from the displayed step. If "EE" is on display, search and playback will be started from step 01.

Changing and Adding of Reserved Programs

- * Press the remote controller CHECK key and display the step to be changed. After pressing the CHECK key once, the step to be changed can also be displayed by the S-ID SEARCH button.
- * Enter the new P-NO. from the numerical keypad.
- * Press the remote controller PGM key. The reserved tune will be changed and the next step displayed. If "EE" is on display, reserved tunes can be added.

<NOTE>

During program playback, if an attempt is made to search the next tune at the end of the reserved tune, a short sound is heard sometimes. This is because the S-ID and the music started at the same instant. In such a case, renumber the TOC (Refer to page 43 ~).

Canceling of Reservation

- Erasing the entire reservation content -

After carrying out "reservation of tune number," the reserved content will be erased if either procedure below is conducted in the stop mode.

- * Press the STOP button.
- * Press the OPEN/CLOSE button.

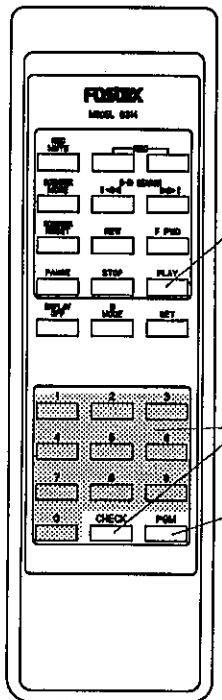
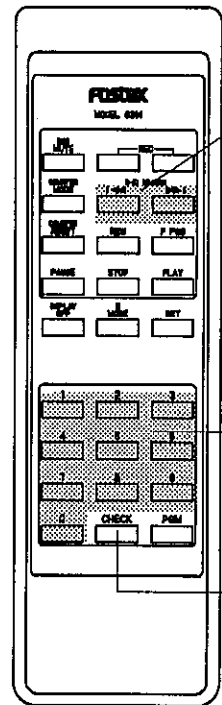

9. Sub Code Editing

9-1. The Sub Code

In the DAT digital signal, in addition to digital audio signals for recording, there is a signal called the sub code for recording the above related information.

By using this sub code, the tape can be manipulated such as carrying out of locate operation and subsequent editing of a tape recording, etc.

Not only can sub code be automatically recorded during a recording session, it can be recorded, rewritten or erased while listening to playback of a tune.

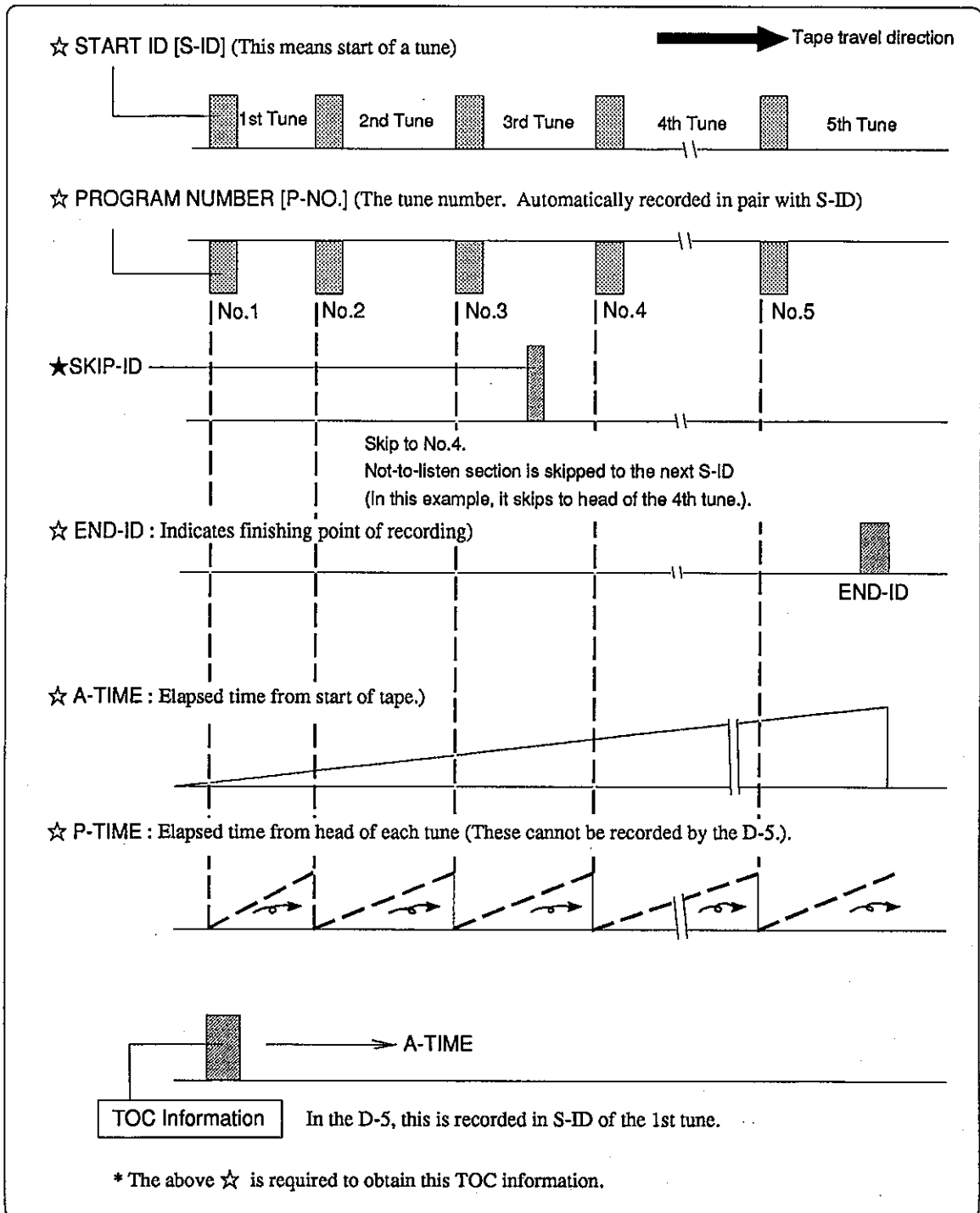

In DAT tapes, as shown below, sub codes which allows various functions of DAT to be done, are recorded in addition to digitized sound signals called PCM signals.

START ID (S-ID)

- This is start information -

[Mark indicating start of tune]

S-ID is automatically recorded at the head of the tune.

It can also be recorded/erased manually.

The ID will be displayed for about 9 seconds for the SP mode and about 18 seconds for the LP mode.

PROGRAM NUMBER (P-NO.)

- Indicates tune number -

[Number indicating the tune sequence]

During recording, a P-NO. is automatically recorded simultaneously with the S-ID.

SKIP-ID

- Skipping information -

[Mark specified when a certain section must be skipped]

When the tape arrives at a point where the SKIP-ID is recorded, it will skip to the next S-ID and start playback.

A SKIP-ID is either manually recorded during recording or manually added during playback.

An ID will be displayed for about one second for the SP mode and about two seconds for the LP mode.

END-ID

- The end information -

[The mark indicating end point of the recording]

This is the end point of the recording and is recorded manually.

When the end search function is used, tape can be quickly moved to the editing point and is thus very convenient at patch recording. If an END-ID is detected during repeat playback, the D-5 will enter automatic rewind mode.

A-TIME

[This is called absolute time and is elapsed time from beginning of tape]

This is recorded when recording from start of the tape and when recording from an intermediate point of any tape recorded with A-TIME.

A-TIME will be displayed based on the SP mode. In the LP mode, actual elapsed time will be twice of that on display.

P-TIME

Program time is the elapsed time of each tune from their start. The D-5 cannot record P-TIME.

TOC information

This TOC is the abbreviation for Table Of Contents. Information such as program time and length of each tune can be obtained.

R-TOC

[This is the format already recorded on commercial music tapes]

This is not what should be recorded by the D-5.

This is recorded in the sub code area throughout the entire length of tape. Regardless of tape position, the TOC will be immediately read upon loading tape in the transport.

U-TOC

[Format for recording TOC on the tape recorded on the D-5]

In the D-5, if nothing is indicated in particular, the TOC will be referring to this U-TOC. Its recording point will be at S-ID of tune #1. Consequently, if TOC is to be read, it is necessary to playback from head of tune #1.

<NOTE>

Because sub code information on the tape will be directly displayed for A-TIME, this will not be shown when a tape without sub code information is played back.

The display in such a case will be "--:--A-TIME." P-TIME can be displayed, although sub code information may not be recorded on the tape, as counting will start from beginning of S-ID during playback.

9-2. Automatic Recording of S-ID

When "AUTO-ID" is switched on by pressing the AUTO-ID button, S-ID and P-NO. will be recorded simultaneous with record start of the tune.

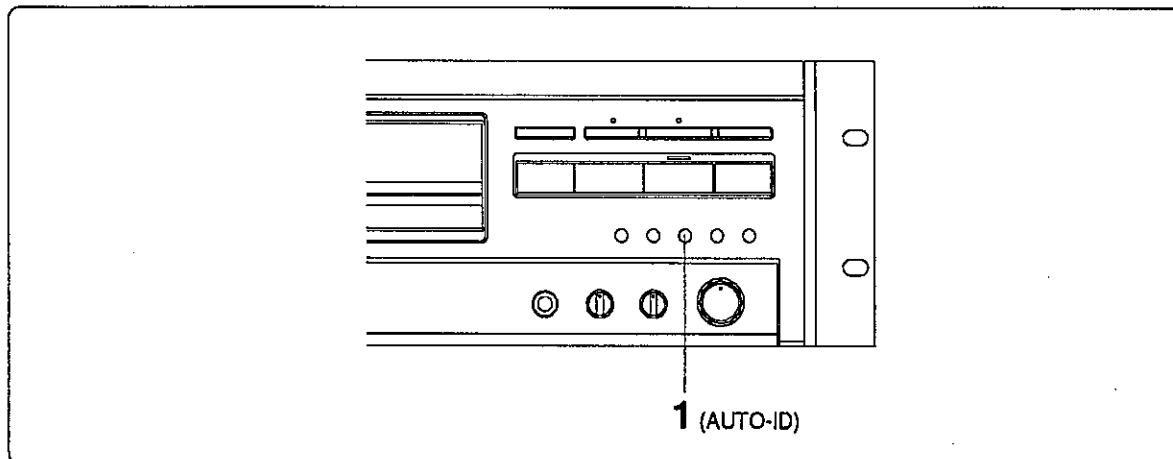

1. Press the AUTO-ID button, before recording.

"AUTO" indicator will be lit.

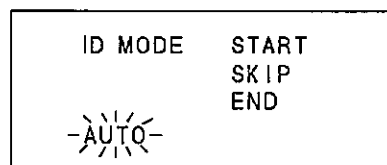

2. Start recording.

Automatic ID Recording by Detecting Space Between Tunes

This will function during both analog and digital recording.

In the D-5, should the tune end during recording (no sound will be detected) and the next tune starts after more than 2 seconds, S-ID and the next P-NO. will be automatically recorded.

If there are low level sections such as in classical music, press the AUTO-ID button to switch it off (AUTO indicator will be extinguished). Under this setting, automatic ID recording by detecting space between tunes will not be performed.

If subsequent S-ID recording is necessary, either record it in an ID during a recording or add/erase the ID and carry out "Renumbering."

<NOTE>

* An S-ID will be recorded automatically if noise is low between tunes but if a large noise occurs in this space such as in analog discs (disc records), tuners and cassette decks, an S-ID may not be recorded.

Q Code Syncro · S-ID Recording

When recording digital input from a compact disc through an optical cable, the D-5 will read the Q code recorded in the compact disc and although there may be no sound between tunes, an S-ID will be accurately recorded. Because this function will automatically activate when the microcomputer determines that the transmitting equipment is a compact disc drive, no special action is needed.

<NOTES>

* When using a CD player which do not output Q codes or when recording from a DAT with no S-ID recorded, switch off the AUTO-ID button and hold it down for more than 4 seconds. When the "AUTO" indicator blinks from this procedure, the D-5 will be changed to the "automatic ID recording by detecting space between tunes" mode.

* In some CD players, Q code will not be output in the digital signals and thus, will not operate correctly. In such a case, press the AUTO-ID button to switch it off, then continuously press it for more than 4 seconds. The AUTO indicator will start blinking and switch to the mode for automatic ID recording at detecting the space between tunes. Please note that this mode will be canceled when power is switched off. To return to the original mode, press the AUTO-ID button again to switch it off.

9-3-2. Manual Recording of an S-ID when Recording

Recording an S-ID at head of the tune without conducting AUTO-ID.

When the D-5 is displaying the P-NO., a P-NO. will be recorded together with S-ID from the next P-NO. If a P-NO. is not on display, an S-ID only will be recorded.

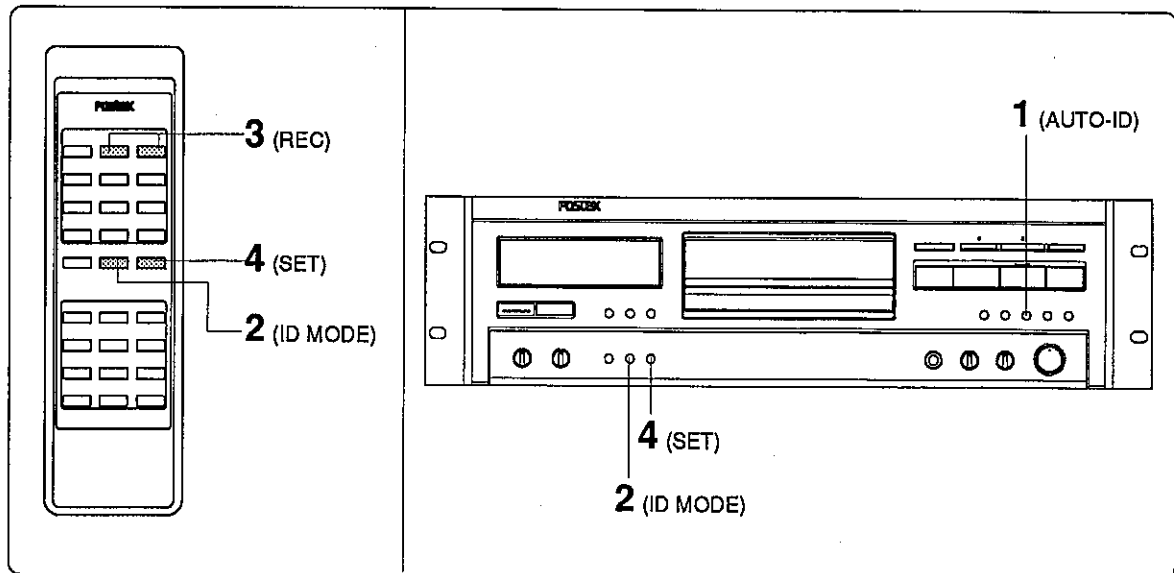

1. Switch off the AUTO-ID button.

"AUTO" indicator will be extinguished.

2. Press the ID MODE button and select "WRITE-START."

ID MODE	▶	START
WRITE		SKIP
		END

3. Start recording.

4. Press the SET button at the head of the tune or desired point.

ID MODE	▶	START	■
WRITE		SKIP	↑
		END	

blink lit

<NOTES>

* Sub code cannot be recorded on a cassette tape protected against mis-recording.

* Provide more than 30 seconds in the A-TIME display between S-ID and the next S-ID.

Buttons other than STOP will not work during sub-code recording and erasing.

9-3-3. Method of Renumbering

"Renumbering" is the process of rerecording P-NO. corresponding to S-ID in successive order from start of tape.

The D-5 has the RENUMBER function which places in order the P-NOs. and, the TOC RENUMBER function which records the Table Of Contents (TOC) at the head section of tape.

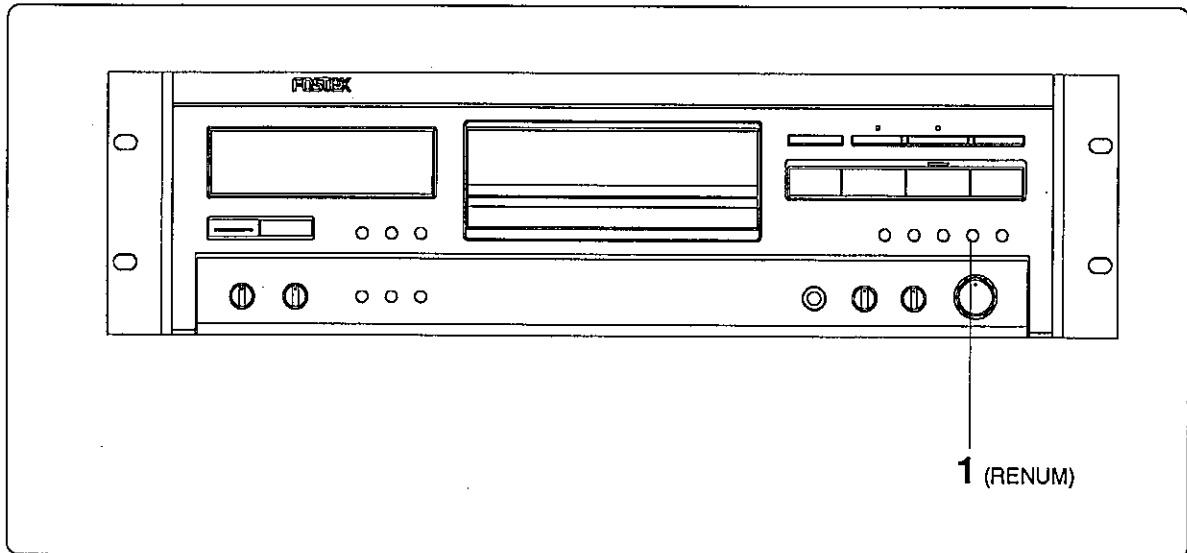

1. Press the RENUM button.

Be sure to carry this out in the STOP mode.

The D-5 will go through the following operations:

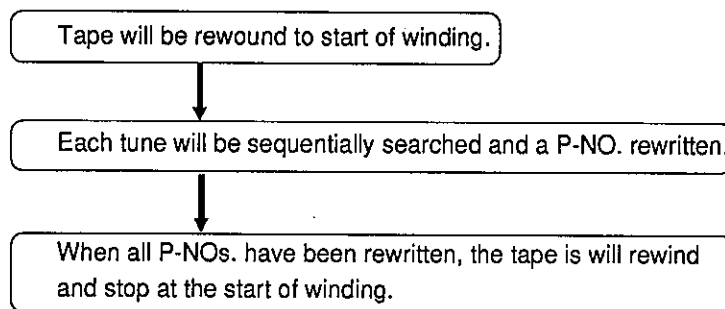

*No sound will be heard during renumbering.

<NOTES>

- * Should an S-ID be added, erased or a cassette is unloaded from the transport and then the tape rerecorded, tune numbers could be duplicated or be missing and therefore, the sub codes cannot be correctly utilized.
- * Cassettes protected against mis-recording cannot be renumbered.
- * When "renumbering" is carried out, if the P-NO. goes beyond "99," thereafter S-ID only will be recorded.
- * During renumbering or TOC renumbering, no other than the STOP button will be effective.
- * Tapes not recorded with a continuous A-TIME or an END-ID is missing although A-TIME is recorded, will be recorded with normal renumbering and TOC renumbering will not be carried out.

9-3-4. Method of TOC Renumbering

The D-5 can read and write TOC information. TOC is an abbreviation of Table Of Contents and information such as program time, length of each tune, etc. are recorded here.

The D-5 can record TOC information up to 50 tunes.

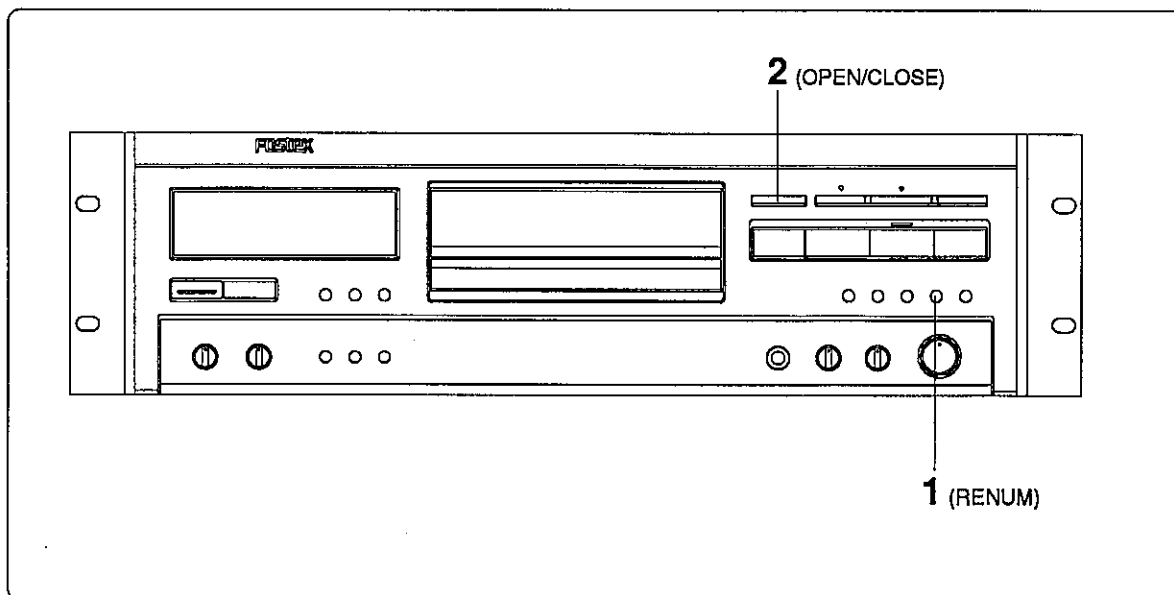

After the finish of recording and immediately after recording END-ID (EE is on display) or cassette is loaded and end is searched -

1. Press the RENUM button.

It will operate as follows:

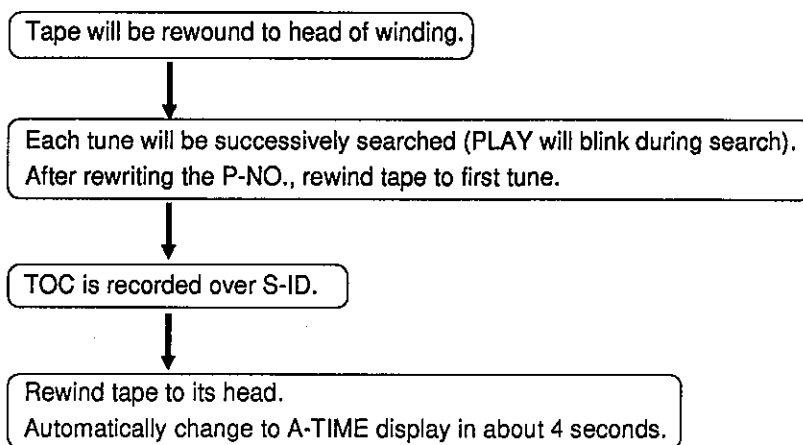

2. Take out the cassette.

3. Open the mis-recording protection door.

This is necessary in tapes written with TOC for data protection.

9-3-5. Reading and Displaying TOC Data

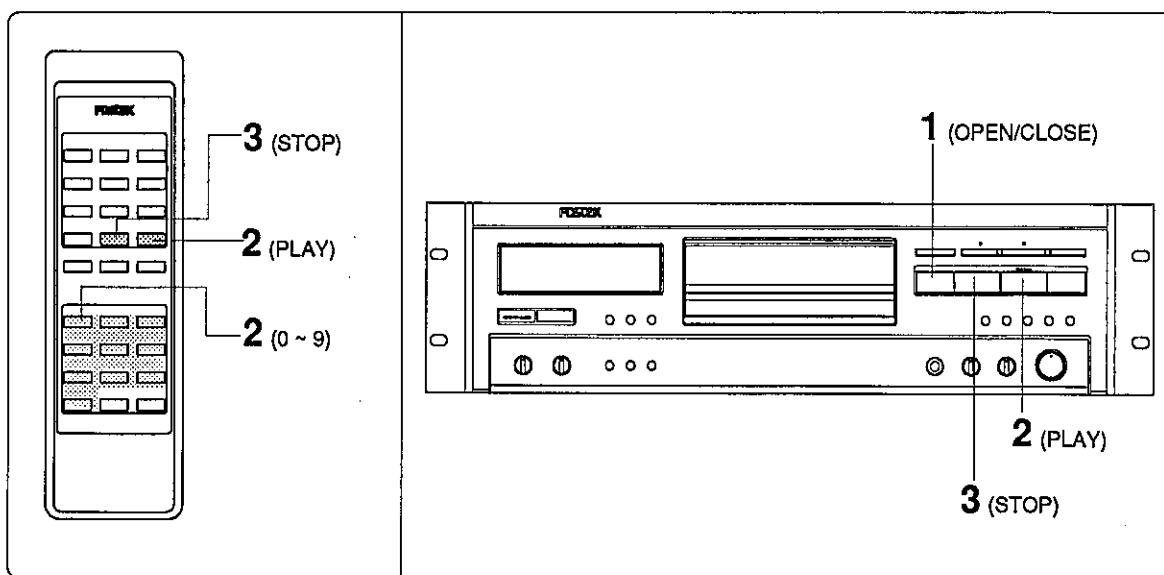

Reading the TOC Data

1. Load the cassette.
2. Press the number "1" button and the PLAY button.
 Search the first tune.
 When TOC is found, "TOC" will blink.
 Upon reading the TOC data, TOC will change from blink to constant light.
3. Press the STOP button.
 While in the STOP mode, when the main unit PLAY button is pressed while pressing the REWIND button, search for the first tune will be started. The TOC data can be read by this operation.

How to Display Total Number of Tunes and Total Time

* Repeat press the COUNTER MODE button until "TOTAL" is displayed.

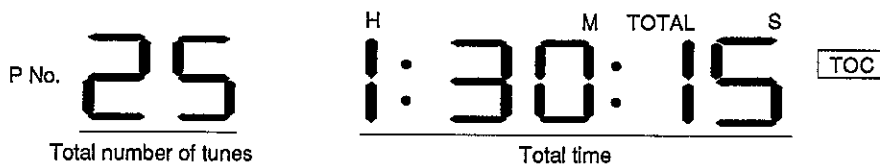
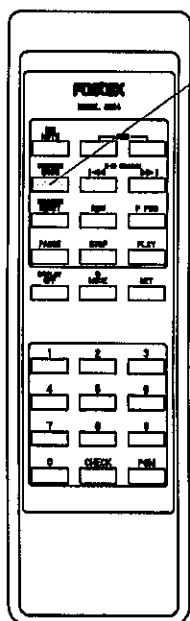

* After TOTAL is displayed for about 4 seconds, it will return to the A-TIME display.

How to Display Length of Each Tune

This can be operated in the stop mode.

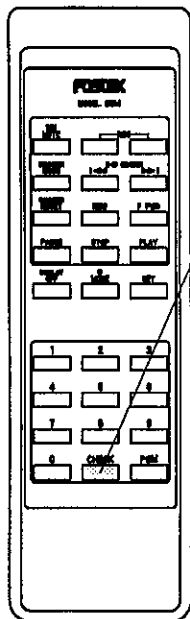

* When the remote controller CHECK button is repeatedly pressed, the display will change as follows:

		H		M		S	P TIME
P No.	01	:	03	:	45		TOC
		H		M		S	P TIME
P No.	02	:	05	:	45		TOC

How to Display Starting Time of Each Tune

This is operated in the stop mode.

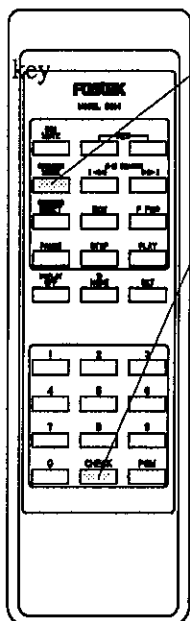

*When the length of each tune is on the displayed:

Press the COUNT MODE key to display A-TIME and then repeat press the CHECK to display the start time of each tune.

		H		M		S	A TIME
P No.	01	:	00	:	10		TOC
		H		M		S	A TIME
P No.	02	:	03	:	55		TOC

<NOTES>

- * After the CHECK button is pressed once, it can also be confirmed with the S-ID SEARCH button.
- * If the PLAY button is pressed while information of each tune is on display, the displayed tune will be directly selected.
- * The TOC indicator will blink during this check mode.
This mode will be canceled when the STOP button is pressed.
- * The number of tunes that can be recorded in TOC is a maximum 50.
- * In the long play (LP) mode, the actual length of each tune will be twice that on display.

9-5. Recording an END-ID

Recording of END-ID is possible in the recording mode or in the record standby mode. This cannot be done in the stop mode.

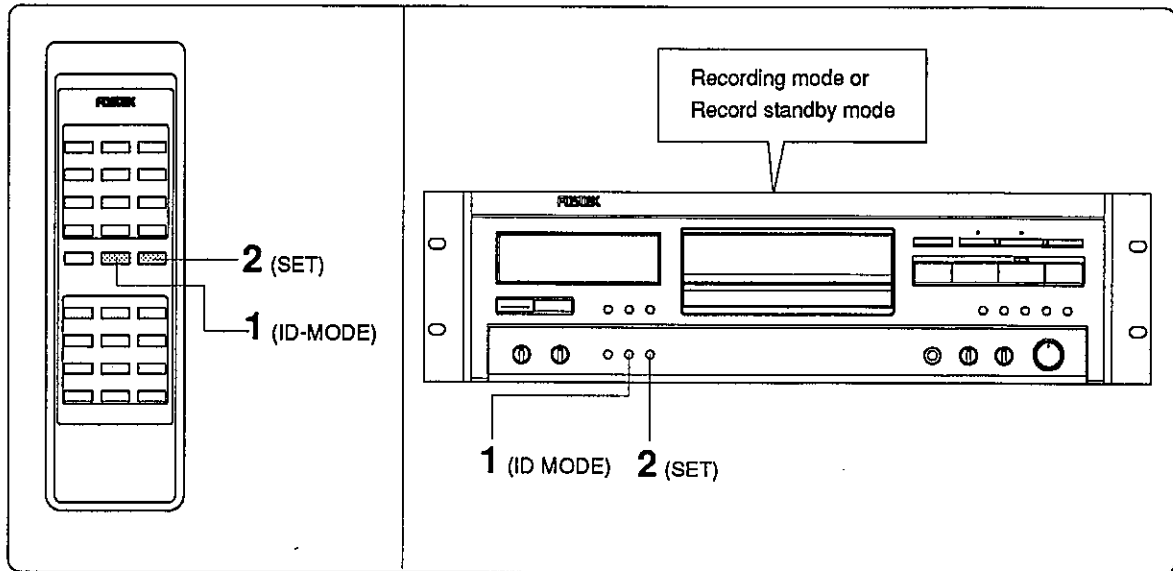

1. Press the ID-MODE button and select "WRITE-END."

ID MODE	START
WRITE	SKIP
	▶ END

2. Press the SET button.

The tune will stop recording from the instant the SET button is pressed.

After recording END-ID for about 9 seconds (SP mode), it will automatically return to head of the END-ID and stop.

After END-ID is recorded, it will not playback beyond it.

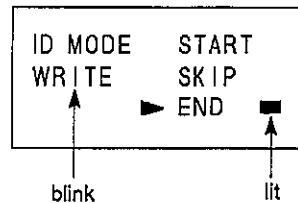

Is recording possible succeeding an END-ID?

Upon finding the last recording, a recording can be continued by using the end search function. In this process, the previously recorded END-ID will be erased. The END-ID can also be erased manually.

Buttons other than STOP will not work during sub-code recording and erasing.

9-6. Erasing an END-ID

END-ID can be erased if recording is not continued after end search but it can also be erased by the following method.

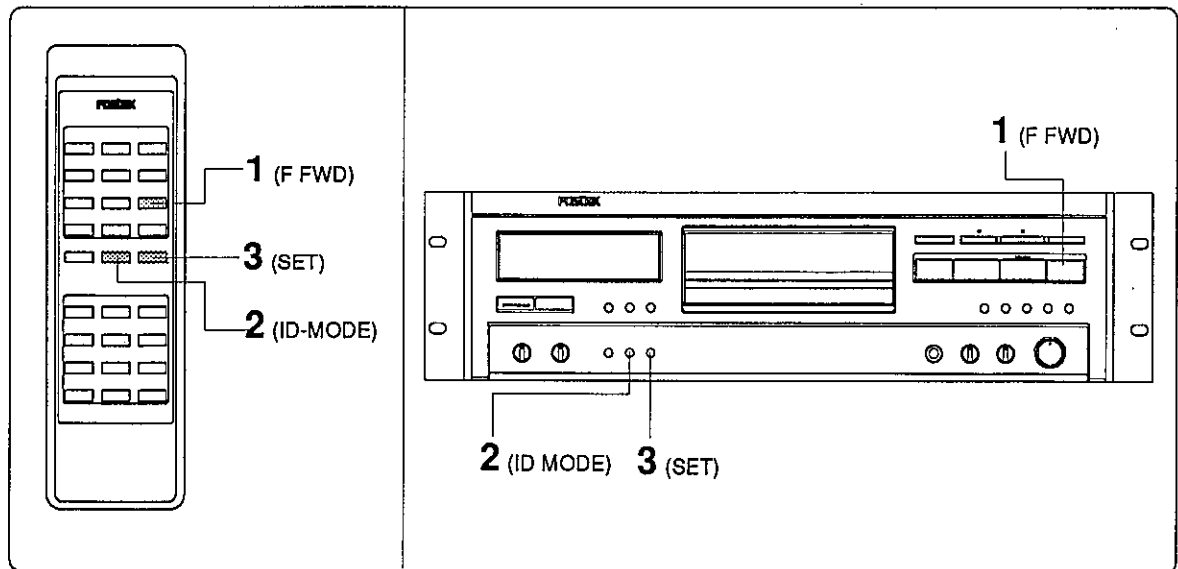

1. Press the F FWD button (end search is carried out).
 "EE" will be displayed upon completing end search.
 "EE" display will not appear at blank search.
2. Press the ID MODE button and select "ERASE-END."

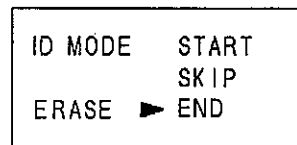

3. Press the SET button.
 After erasing, it will automatically return to its original position and stop.

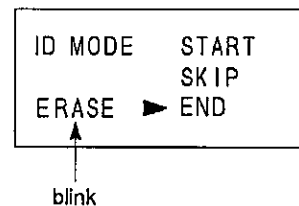

<NOTE>

When executing a record/erase of an S-ID or SKIP-ID on a tape recorded with time code on another DAT recorder (D-10, D-30, etc.), please remember that time code continuity will be interrupted. The time code cannot be recorded by the D-5.

Buttons other than STOP will not work during sub-code recording and erasing.

9-7. Recording a SKIP-ID at the Desired Point

The undesired section can be skipped.

During playback, a SKIP-ID can be recorded at the desired point.

CM and narration can be skipped. The SKIP-ID is recorded at the start of the section to be skipped.

When a SKIP-ID is found during playback, the D-5 will skip to the next S-ID.

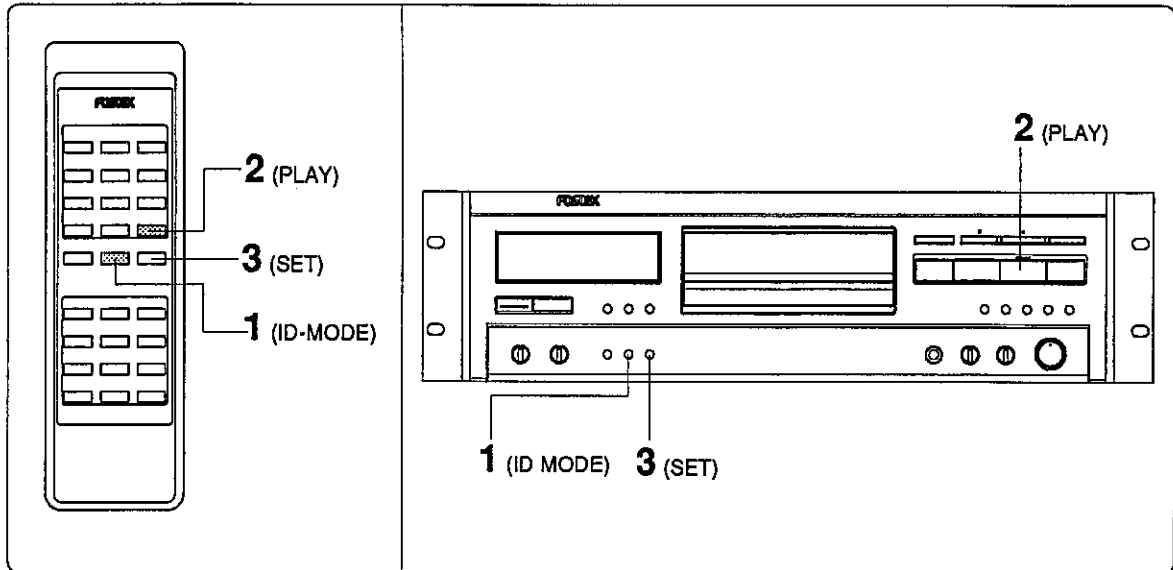

1. Press the ID MODE button and select "WRITE-SKIP."

ID MODE	START
WRITE	▶ SKIP
	END

2. Press the PLAY button.

Playback from slightly before where SKIP-ID is to be recorded.

If this point is overshoot, press the << button.

If the FINE CUE function (page 28) is used in place of the PLAY button, it can be recorded from a more accurate position.

As it will automatically enter the S-ID recording mode after recording the SKIP-ID, the skip end point can be recorded after it.

3. Press the SET button at the desired position.

SKIP-ID is recorded for about one second. No sound will be heard during this recording.

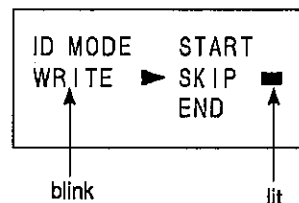

Recording SKIP-ID During a Recording Session

Press the ID-MODE button while in the recording mode, select "SKIP," press the SET button and a SKIP-ID will be recorded.

<NOTE>

When executing a record/erase of an S-ID or SKIP-ID on a tape recorded with time code on another DAT recorder (D-10, D-30, etc.), please remember that time code continuity will be interrupted.

The time code cannot be recorded by the D-5.

9-8. Erasing an Unnecessary SKIP-ID

Unnecessary SKIP-ID can be erased during playback (it can also be erased in the stop mode). This cannot be erased in cassette tapes protected against mis-recording.

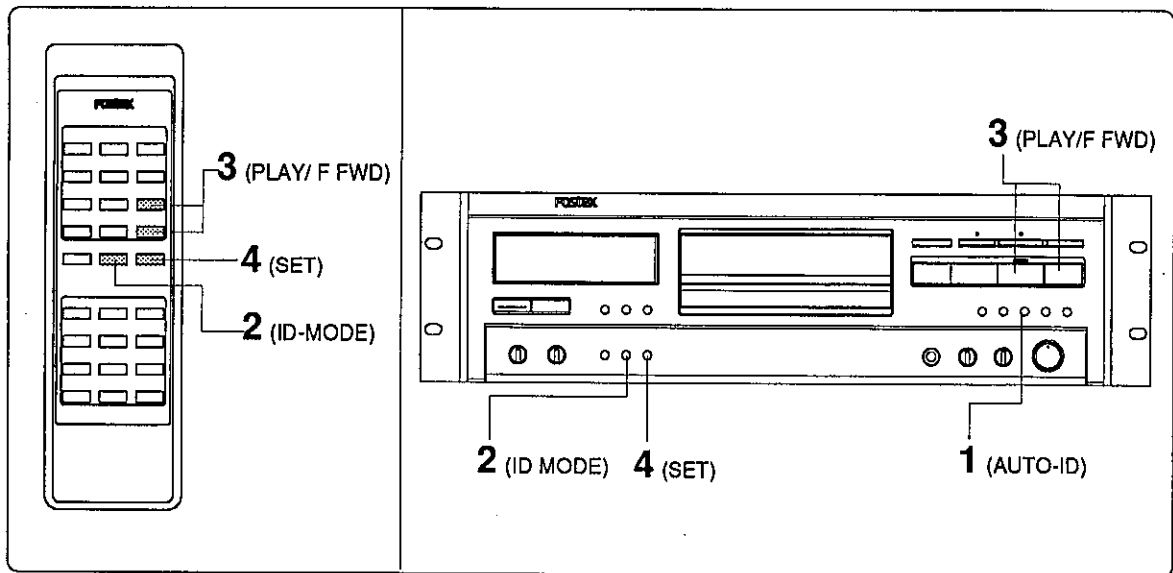

1. Switch off the AUTO-ID button.
AUTO indicator will be extinguished.
2. Press the ID-MODE button and select "ERASE-SKIP."

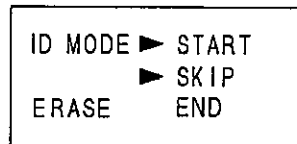

3. SKIP-ID will be searched.
Search for the SKIP-ID with CUE, press the PLAY button from beforehand of this SKIP-ID and enter the playback mode.

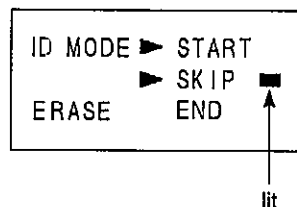

4. Press the SET button at where the ID mark is lit or where it ceases to be lit.

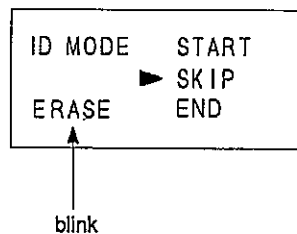

<NOTE>

When executing a record/erase of an S-ID or SKIP-ID on a tape recorded with time code on another DAT recorder (D-10, D-30, etc.), please remember that time code continuity will be interrupted. The time code cannot be recorded by the D-5.

Buttons other than STOP will not work during sub-code recording and erasing.

Specifications

Type	Rotating head digital audio tape recorder
Tape Speed	8.15mm/s (SP), 4.075mm/s (LP), 12.225mm/s (playback only, 1.5 TP)
Recording Time (on standard 120' tape)	SP mode: Max. 120 minutes (D-120 tape) LP mode: Max. 240 minutes (D-120 tape)
Number of Channels	2 channel stereo
Quantization Bit Number (*)	16 bit linear 12 bit non-linear
Sampling Frequency (*)	48kHz 44.1kHz 32kHz

(*) Sampling Frequency	48kHz	44.1kHz	32kHz	32kHz
(*) Quantization Bit Number	16 bit	16 bit	16 bit	12 bit
Tape Speed	SP	SP	SP	LP
Analog Input	○	○	×	○
Digital Input	○	○	○	○
Analog Output	○	○	○	○
Digital Output	○	○	○	○

Error Correcting Method	Double encoded Reed Solomon code
Modulation Type	8-10 conversion
Emphasis	Analog recording: Fixed at OFF. Playback: Automatic switching.
Head	High output sendust head
Standard record level	-12dB
Record/Playback Frequency Characteristics	SP: 20Hz ~ 20kHz +/-1dB LP: 20Hz ~ 14.5kHz +/-1dB
SN Ratio	Higher than 90dB
Dynamic Range	Higher than 90dB
Total Harmonic Distortion	Less than 0.05% (1 kHz, standard recording level: +4dBu)
Wow Flutter	Less than measurement limit ($\pm 0.001\%$ WTD .PEAK)
Analog Input/Output Connectors	
Analog Audio Input	
Connector	XLR-3-31 (Pin 1: GND, Pin 2: HOT, Pin 3: COLD)
Standard input level	Switchable to +4dBu/-10dBV
Input impedance	10k Ω
Analog Audio Output	
Connector	XLR-3-32 (Pin 1: GND, Pin 2: HOT, Pin 3: COLD)
Standard output level	Switchable to +4dBu/-10dBV
Output load impedance	Higher than 600 Ω
Headphone Output	
Connector	Stereo standard phone jack ϕ 6mm
Max. output level	Higher than 40mW (at 32 Ω)
Output load impedance	Higher than 8 Ω

Digital Input/Output

AES/EBU Digital Input	
Connector	XLR-3-31 (Pin 1: GND, Pin 2: HOT, Pin 3: COLD)
Input Format	Comply to AES/EBU specs.
S/PDIF Digital Input	
Connector	Optical
Input Format	Comply to IEC Consumer
AES/EBU Digital Output	
Connector	XLR-3-32 (Pin 1: GND, Pin 2: HOT, Pin 3: COLD)
Output Format	Comply to AES/EBU specs.
S/PDIF Digital Output	
Connector	Optical
Output Format	Comply to IEC Consumer
GPI Input (Parallel Remote Input Connector)	
Connector	DIN 5 PIN
	Pin 1: GND
	Pin 2: STOP
	Pin 3: PLAY
	Pin 4: S-ID Search >>
	Pin 5: S-ID Search <<
	* PNP transistor input, Low Active (4.7k Ω /5V Pull Up)

Power Supply and Others

Power Source/Power Consumption	120VAC 60Hz, 28W 230V \sim 50/60Hz, 28W
Physical Dimensions	482 (W) x 134 (H) x 383.5 (D) mm
Total Weight	Approx. 6.8kg

Accessories

Wireless remote control unit (Model 8314)
Batteries for remote control (UM-4; IEC-R03)
Owner's Manual

* Specifications and appearance of this product subject to change without notice.

Physical Dimensions

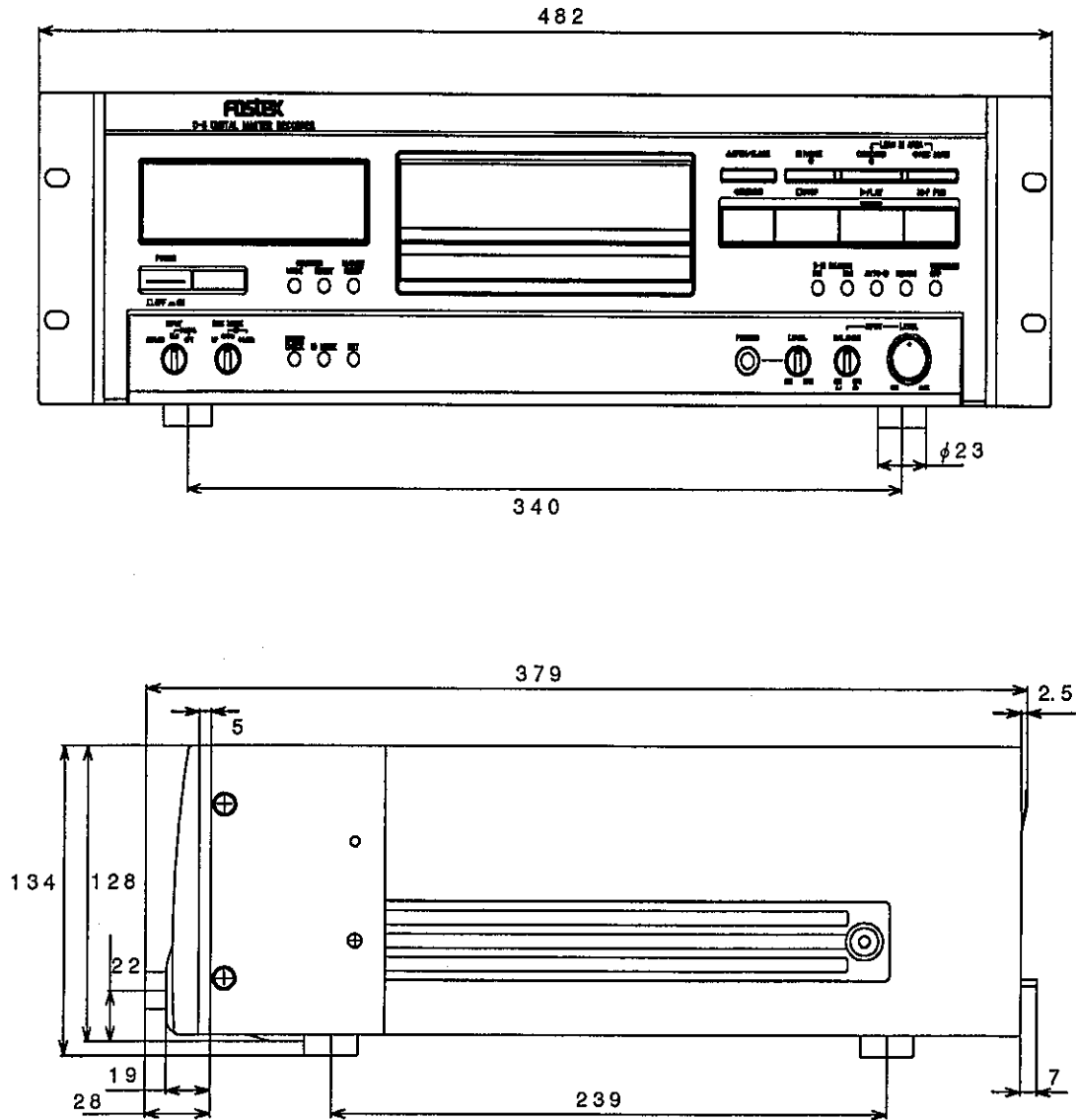

MEMO



FOSTEX

FOSTEX CORPORATION

3-2-35 Musashino, Akishima-shi, Tokyo, Japan 196

FOSTEX CORPORATION OF AMERICA

15431, Blackburn Ave., Norwalk, CA 90650, U. S. A.