



DVD LOCATION RECORDER **Model PD-6**

Operation Manual



<DANGER>
VISIBLE OR INVISIBLE LASER RADIATION WHEN OPEN.
AVOID DIRECT EXPOSURE TO BEAM.

<CAUTION>

- Use of controls or adjustments or performance of procedures other than those specified herein may result in hazardous radiation exposure.
- The use of optical instruments with this product will increase eye hazard.

CAUTION

About DVD-RAM disks used with the PD-6

With the PD-6, only use DVD-RAM disks which is confirmed by Fostex.

Operation confirmed disk model: MAXELL DRMS-V28R (8-centimeter DVD-RAM disk, double sided) *as of March 2003.

<Important notice>

Fostex does not guarantee the operation of the PD-6 when using a disk which is not recommended by Fostex.

About disk formatting

Before starting recording, be sure to format the disk in either of the following ways.a

- **For a brand-new disk:**
Carry out the initial format (see page 24 in the operation manual).
- **For a used disk:**
Carry out the physical format (see page 115 in the operation manual).

***** Caution when formatting a DVD-RAM disk *****

Even when trying to format a used 8 cm DVD-RAM disk on which many alternative sectors exist by the “Normal mode”, PD-6 forces to “Physical Format” a disk.

Because of this, only the “On” setting of “Physical Format” in the formatting procedures can be selected.

Although it takes time to Physical Format a disk, please do so according to the instruction on the LCD display.

Refer to page 115 ~ 117 of PD-6 operation manual for physical formatting a disk.

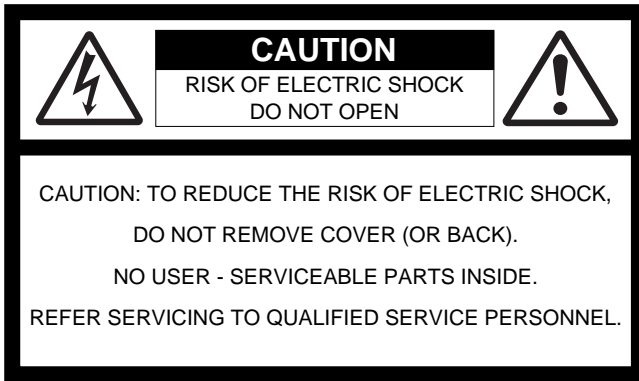

"WARNING"

"TO REDUCE THE RISK OF FIRE OR ELECTRIC SHOCK, DO NOT EXPOSE THIS APPLIANCE TO RAIN OR MOISTURE."

SAFETY INSTRUCTIONS

1. Read Instructions - All the safety and operating instructions should be read before the appliance is operated.
2. Retain Instructions - The safety and operating instructions should be retained for future reference.
3. Heed Warnings - All warnings on the appliance and in the operating instructions should be adhered to.
4. Follow Instructions - All operating and use instructions should be followed.
5. Water and Moisture - The appliance should not be used near water - for example, near a bathtub, washbowl, kitchen sink, laundry tub, in a wet basement, or near a swimming pool, and the like.
6. Carts and Stands - The appliance should be used only with a cart or stand that is recommended by the manufacturer.



An appliance and cart combination should be moved with care. Quick stops, excessive force, and uneven surfaces may cause the appliance and cart combination to overturn.

7. Wall or Ceiling Mounting - The appliance should be mounted to a wall or ceiling only as recommended by the manufacturer.
8. Ventilation - The appliance should be situated so that its location or position does not interfere with its proper ventilation. For example, the appliance should not be situated on a bed, sofa, rug, or similar surface that may block the ventilation openings; or, placed in a built-in installation, such as a bookcase or cabinet that may impede the flow of air through the ventilation openings.
9. Heat - The appliance should be situated away from heat sources such as radiators, heat registers, stoves, or other appliances (including amplifiers) that produce heat.

CAUTION:

TO PREVENT ELECTRIC SHOCK, MATCH WIDE BLADE OF PLUG TO WIDE SLOT, FULLY INSERT.

ATTENTION:

POUR ÉVITER LES CHOCS ÉLECTRIQUES, INTRODUIRE LA LAME LA PLUS LARGE DE LA FICHE DANS LA BORNE CORRESPONDANTE DE LA PRISE ET POUSSER JUSQU' AU FOND.



The lightning flash with arrowhead symbol, within an equilateral triangle, is intended to alert the user to the presence of uninsulated "dangerous voltage" within the product's enclosure that may be of sufficient magnitude to constitute a risk of electric shock to persons.



The exclamation point within an equilateral triangle is intended to alert the user to the presence of important operating and maintenance (servicing) instructions in the literature accompanying the appliance.

10. Power Sources - The appliance should be connected to a power supply only of the type described in the operating instructions or as marked on the appliance.
11. Grounding or Polarization - The precautions that should be taken so that the grounding or polarization means of an appliance is not defeated.
12. Power Cord Protection - Power supply cords should be routed so that they are not likely to be walked on or pinched by items placed upon or against them, paying particular attention to cords at plugs, convenience receptacles, and the point where they exit from the appliance.
13. Cleaning - The appliance should be cleaned only as recommended by the manufacturer.
14. Nonuse Periods - The power cord of the appliance should be unplugged from the outlet when left unused for a long period of time.
15. Object and Liquid Entry - Care should be taken so that objects do not fall and liquids are not spilled into the enclosure through openings.
16. Damage Requiring Service - The appliance should be serviced by qualified service personnel when:
 - A. The power supply cord or the plug has been damaged; or
 - B. Objects have fallen, or liquid has been spilled into the appliance; or
 - C. The appliance has been exposed to rain; or
 - D. The appliance does not appear to operate normally or exhibits a marked change in performance; or
 - E. The appliance has been dropped, or the enclosure damaged.
17. Servicing - The user should not attempt to service the appliance beyond that described in the operating instructions. All other servicing should be referred to qualified service personnel.
18. The appliance should be situated away from drops of water or spray of water.
19. Objects containing liquid such as vase must not be put on the appliance.
20. The appliance is not completely isolated from the power supply even if the power switch is at off position.

Table of contents

Precautions	8
Precautions on safety	8
Precautions on installation	9
About this manual	10
Manual organization	10
Rules of manual description	12
Chapter 1: Introduction	13
Introduction	14
Main features / functions	14
What is in the box	16
PD-6 options and related Fostex products	16
Chapter 2: Before using the PD-6	17
About power supply	18
About battery	18
Charging the battery	18
Installing the battery	18
Removing the battery	19
Saving the battery power	19
About AC adaptor	20
Connecting the AC adaptor	20
Turning on the power	21
About power supply voltage	21
About Realtime clock	22
About DVD-RAM disk	22
Inserting / removing a disk	23
About recording modes	26
Chapter 3: Names and functions	27
Left side panel (Inputs / outputs)	28
Right side panel (Inputs / outputs)	30
Front panel (part 1)	32
Front panel (part 2)	34
Front panel (part 3)	37
Top panel (part 1)	38
Top panel (part 2)	41
LCD display	43
Initial screen (Normal screen)	43
Other screens	44

Chapter 4: Basic connections	47
Input connection	48
Analog audio input connection	48
Digital audio input connection	49
Time code input connection	49
Sync signal connection	49
Monitor signal input connection	50
Output connection	50
Analog audio output connection	51
Digital audio output connection	51
Time code output connection	51
Word clock output connection	51
Monitor output connection	51
Connection examples	52
Connection example for recording (1)	52
Connection example for recording (2)	53
Other connection examples	54
Example of PC connection	54
Example of USB keyboard connection	54
Power supply for external devices	55
 Chapter 5: Recording / playback	 57
Recording analog audio	58
Selecting an input source	59
Adjusting the input gain	59
Filter setting	60
Limiter setting	60
Selecting the sampling frequency	61
Selecting recording tracks	62
Selecting a recording source	63
Adjusting the recording level	63
Monitoring recording signals	64
Making recording	65
Recording with the PRE REC mode active	66
Recording a slate tone/slate mic signal	67
About overloading	67
File names of created audio files	68
Recording digital audio	69
Selecting digital input channels	69
Selecting the sampling frequency	69
Selecting the system master clock	69
Recording time code	70
Selecting the TC frame rate	70
Selecting the TC generate mode	71
Setting the time code output	71
Jam function	72

- Creating cue points73
 - Creating a cue point automatically at the recording start point73
 - Creating a cue point on-the-fly73
 - Viewing the cue point list74
 - Editing a cue point74
 - Creating a new cue point using the cue list screen75
- Playback76
 - Normal audio playback76
 - Time code playback77
 - Cueing playback77
- Skip/locate functions78
 - Skipping by file78
 - Skipping by cue point78
 - Locating to the beginning (ABS 0) of a file78
 - Locating to the end (REC END) of a file78
 - Locating to the previous locate point78
 - Locating to the desired time79
 - Locating to the desired cue point79

Chapter 6: TC Setup mode81

- How to select the TC Setup menu82
- Editing the LTC start time82
- Time code output while paused83
- User bit setting of playback time code84
- Editing the internal time code generator setting85
- User bit setting of internal generator time code86
- Jam mode setting86

Chapter 7: Setup mode87

- Setup menu details88
- How to select a Setup menu89
- How to make Setup menu setting90
 - Adjusting the real-time clock (Adjust RTC)90
 - Setting the digital out format (Digital out)91
 - Digital input channel setting (Digital in)91
 - Skip mode setting (Skip mode)92
 - Diagnoses on/off setting (Diagnoses)92
 - Reference level setting (Reference level)93
 - Peak hold time setting (Peak hold)93
 - Slate tone recording time and mode setting (Tone rec mode)94
 - Auto cue mode on/off setting (Auto cue)95
 - Pause cancel time setting (Pause time)95
 - Error tone output setting (Error tone)96
 - Battery warning setting (BATT warning)97
 - Speaker mute on/off setting (Speaker mute)97
 - Limiter parameter setting (Limiter parameter)98
 - Default file name setting (Default file name)99

Default track name setting (Default track name)	100
Next event number setting (Next event No.)	100
USB keyboard type setting (Keyboard)	101
Pre-record time setting (Pre rec time)	101
Setup data saving (Save user setup)	102
Setup data loading (Load user setup)	102
ROM version checking (Version)	103
Chapter 8: Utility mode	105
Utility menu details	106
How to select a Utility menu	107
Editing a file name [Edit file name]	108
Editing a file information editing [File info.]	109
Checking file information	109
Checking a description information	109
Editing a description information	111
Adding a description information	111
Deleting a description information	111
Deleting an unnecessary audio file [Delete file]	112
Restoring a deleted audio file [Restore Del. file]	113
Optimizing the current disk [Optimize disk]	114
Formatting the current disk [Format]	115
Editing the reel number (volume label) [Reel No.]	118
Selecting the record protection “On” or “Off” [Rec protect]	119
Selecting the resume function “On” or “Off” [Resume]	120
Setting IEEE1394 connection [IEEE1394]	121
Chapter 9: EDL SEL mode	123
Creating a new ALE file	124
Adding audio files to an ALE file	127
Viewing and editing audio file entries	129
Viewing audio file entries	129
Adding an audio file entry to an existing ALE file	130
Deleting an audio file entry	130
Editing an ALE file	131
Editing an ALE file name	131
Remaking an ALE file	132
Deleting an ALE file	133
Chapter 10: Exporting files using IEEE1394	135
Connection between the PD-6 and a PC	137
How to disconnect the PD-6	137
Example of copying data to an external hard disk	138
Example of exporting data to a computer application	138
Chapter 11: Specifications	141

Precautions

Precautions on safety

- Avoid excessive heat and humidity.
Do not expose the PD-6 to extremes of humidity. Do not place the unit in direct sunlight, close to heating units, or in areas subject to high temperatures. Also avoid areas subject to extremely low temperatures. The PD-6's ambient operating temperature is between 0° and 45°C.
- Avoid excessive dust and vibration.
Locations which are subject to excessive dust accumulation or vibration which could cause mechanical damage.
- Avoid physical shocks.
Strong physical shocks can cause damage. Handle the unit with care.
- Avoid damaging the power cord.
Make certain that the PD-6's power cord is not located in a position where it is likely to be walked on or pinched by other equipment placed near the cord.
- Do not open the case or attempt repairs or modification yourself.
The PD-6 contains no user-serviceable parts. For other than routine cleaning, refer all maintenance to qualified FOSTEX service personnel. To reduce the risk of electric shock, do not open the case. Opening the case and/or tampering with the internal circuitry will void the warranty.
- While the unit is accessing the disk, such as during recording, never turn off the power. Make sure that the disk completely stops rotation when you turn off the power. Otherwise, recorded data may be lost, as well as a DVD-RAM disk may be damaged.

Note that Fostex assume no responsibility on data loss or whatsoever due to use of the unit.

- **FOSTEX is not responsible for any "direct damage" or "indirect damage" caused by using the PD-6.**
- When supplying the power to the unit from the AC power socket, only use the Fostex Model AD-15C AC adaptor (note that the AD-15C is an option). If you use any other AC adaptor, the unit may not work correctly and there is a serious risk of damage to the unit.
- Make sure that the voltage of your AC power socket matches the voltage requirements printed on the AC adaptor.
- When running the unit with a battery, use the IDX NP-L50, IDX NP23, Sony NP-1 or equivalent. "We recommend to use a fully charged battery."
- Always remove/replace a battery or plug/unplug the AC adaptor with the unit [POWER] switch set to "OFF". Otherwise, the data may be damaged because the unit always transfers data between the disk and memory.

- Do not let water or other liquid, or metal objects such as pins, accidentally enter the inside of the unit because this may lead to electric shock or damage. Should water enter the inside of the unit, turn off the power, unplug the power cord from the AC adaptor and remove the battery, and consult your dealer or the nearest FOSTEX service station.
- Do not drop the unit or give it a strong shock. The internal circuits, display, panels may be damaged. Although the unit is designed to be used outside, handle the unit with great care because it is a precision machine.
- When using the supplied carrying belt, to prevent the unit from dropping accidentally, make sure that it is attached to the unit correctly.
- Do not give a strong shock to the LCD display. The liquid used inside the LCD display is toxic. If the liquid is spilled, do not suck it in. If it is stained to your hand or skin, wash immediately with plenty of water.
- Clean with a soft dry cloth.
Never use solvents such as benzine or thinner to clean the PD-6.
Wipe it clean with a soft dry cloth. If further cleaning is required, a lightly moistened cloth with a mild detergent may be used.

<Important!>

Equipment name, electrical ratings, serial number and other information for the PD-6, are written on bottom side.

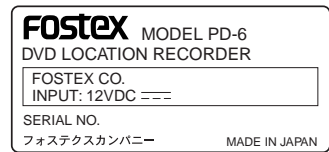

Precautions on installation

• **Do not install the unit in the following conditions**

- in a extremely hot or cold place
- in a moist place
- in a dusty place
- in a strong magnetic field or near a device which generates a magnetic field
- in the direct sunshine

• **Notes on waterproof**

The panels of the unit are designed to prevent waterdrops from entering inside, however, the unit is not perfectly waterproofed. So do not use the unit in an extremely moist place or in a circumstance where the unit catches the rain or spray directly.

• **Notes on moisture condensation**

When you bring the unit from a cold place to a warm place, moisture may condense on the drive, display, panels, etc. In such a case, leave the unit for a while until it warms up and evaporates any moisture.

About this manual

The following is a guide to the manual for our Fostex PD-6 DVD Location Recorder.

This manual is divided into chapters. Each chapter covers instructions for a specific subject or feature of the PD-6. You should know this information before using the recorder, as well as the safety instructions, precautions, etc. Please retain this manual at hand so that you can refer to it whenever necessary.

Manual organization

The following gives a brief description of each chapter:

Chapter 1: Introduction

This chapter gives a brief introduction to the PD-6, and also describes the main features of the recorder.

Chapter 2: Before using the PD-6

Chapter 2 describes the power supply as well as details about formatting a DVD-RAM disk. You should definitely read this chapter first before using the PD-6.

Chapter 3: Names of Functions

Refer to this chapter for the names and functions of the keys and controls on the front and top panels, as well as for the connectors on the left and right side panels.

If you are familiar with digital equipment, you are probably familiar with much of this information concerning the PD-6.

Chapter 4: Basic connection

This chapter describes basic connections between the PD-6 and external devices. It includes details about how to connect analog audio signals, digital audio signals, an external time code and external synchronization signals. Refer to this chapter for information on how to connect the PD-6 and a personal computer via IEEE 1394, and how to make a USB keyboard connection.

Chapter 5: Recording/playback

Chapter 5 describes audio and time code recording/playback using the PD-6. Here you will find the information necessary to make switch settings and adjustments for audio and time code recording/playback, as well as about force jamming.

Chapter 6: TC Setup mode

This chapter describes the TC Setup mode, which provides preferences and settings related to time code recording/playback, such as settings for the TC start time and TC user bits.

Chapter 7: Setup mode

This chapter details the Setup mode. By using the Setup mode menus, you can set preferences, etc. for the PD-6. The following menus are available in the Setup mode:

<IMPORTANT>

Setup mode menus may change when the PD-6 software is periodically updated.

Real Time Clock menu	Check or edit the internal realtime clock.
Digital Out menu	Select the digital output signal format between AES/EBU and SPDIF.
Digital In menu	For switching the input channel sources between digital and analog.
Skip mode menu	You can select the function of the [SKIP/CURSOR] key.
Diagnoses menu	Use this menu to select whether or not to log errors during recording to the diagnosis file.
Reference level menu	Select the PD-6 reference input level.
Peak hold time menu	You can set the peak hold time of the level meters.
Tone rec mode menu	For setting recording duration and mode of the slate tone.
Auto cue menu	You can select whether automatically recording a cue point or not at the record start position.
Pause time menu	You can set the pause cancel time.
Error tone menu	Select error tone on or off.
BATT warning menu	For setting the threshold of the battery power voltage for generating the error tone.
Speaker mute menu	You can select whether muting the monitor speaker or not except during recording.
Limiter parameter menu	Set the limiter parameters here.
Default File name menu	You can select the name form of an audio file, when it is created between date information base and scene/take number information base.
Default track name menu	Use this menu to specify the default track name of audio files.
Next event menu	You can set the event number of audio files.
USB keyboard menu	Use this menu to select the USB keyboard type to be connected between US and JAPAN.
Pre rec time menu	You can set the pre-record time of audio pooled in the buffer.
User setup save menu	Sets up data to the user box.
User setup load menu	Go here to load the setup data from the user box.
Version menu	This menu is for checking the PD-5 software version.

Chapter 8: Utility mode

This chapter describes the Utility mode, in which you can make settings related to the DVD-RAM disks to be used with the PD-6, as well as to format a disk. The following menus are available in the Utility mode.

<IMPORTANT>

The Utility mode menu may change as the PD-6 software is updated.

Edit File Name menu	You can edit audio file names.
File Info. menu	Use this menu to check the audio file information, as well as edit the description information.
Delete File menu	For deleting an audio file.
Restore Del File menu	You can restore the deleted file.
Optimize Disk menu	This menu is for optimizing the current disk.
Format menu	Format information is located here.
Reel No. menu	You can edit the reel No. (volume label).
Rec Protect menu	This menu selects record-protection enabled or disabled.
Resume menu	You can select resume-function enabled or disabled.
IEEE1394 menu	Select whether IEEE1394 connection is enabled or disabled.

Chapter 9: EDL SEL mode

This chapter describes how to create an ALE file from a recorded audio file for use in an AVID system, as well as how to edit an ALE file information.

Chapter 10: Exporting files using IEEE1394

Chapter 10 describes how to transfer audio files between the PD-6 and a personal computer using IEEE1394.

Chapter 11: Main specifications

This chapter describes PD-6 specifications for mechanical and electronic characters, etc.

Notes on descriptions used in this manual

1. The following abbreviations are sometimes used:

Time code	-> TC
External time code	-> EXT TC
Internal time code generator	-> INT TC GEN
Sampling frequency	-> Fs
2. The names of keys and other connectors and controls of the PD-6 expressed in this manual match the panels described.
3. On-screen messages and switch position names are in quotes (“ ”).
4. The on-screen messages and items, as well as the indicators on the panel, “light” or “flash”.
5. “Notes” give tips or advice on proper use of the PD-6. “Caution” notices give advice regarding any possible hazards to the equipment or user. Please read these extra carefully.

Chapter 1: Introduction

This chapter describes the introduction and main features/functions of the PD-6.

Introduction

The model PD-6 is a portable 6-track DVD location recorder using an 8-centimeter DVD-RAM disk as a recording medium.

To get the best performance in the circumstance of location recording, the PD-6 is equipped with a six-channel mixer in a light-weighted and small body, and you can make reliable long-time recording with an internal battery (equivalent to the NP-1 type). The PD-6 also offers video/word sync capability, allowing the perfect synchronization to video/picture equipment such as a video camera. In addition, it is equipped with a connector, conformed to IEEE1394, for direct connection to a personal computer, allowing transferring recorded audio file data to a personal computer for editing.

The versatile functions of the PD-6 make it the best location audio recorder for broadcasts and post productions.

Main features/functions

- Equipped with an ATAPI 8-centimeter DVD-RAM drive. This drive is designed vibrationproof, and ensures high-speed access and reliability, which only the optical disk system can afford.
- The DVD-RAM disk format is conformed to “UDF Rev1.5”, which ensures great compatibility with personal computers.
- The recording file format is conformed to the BWF interleave 1 file specification. When a file is imported to a DAW such as the Pro Tools from the PD-6, it is separated to mono files.
- Various recording track modes are available. You can select a desired track mode from among 2, 4, 5 and 6, as well as 2+4 and 1+5 track modes.
- Supports 44.1 kHz, 48 kHz, 88.2 kHz and 96 kHz sampling frequencies with 24 bit quantization. At 44.1 kHz or 48 kHz sampling frequency, you can also select 16 bit quantization.
- Supports video and word synchronization, allowing the PD-6 synchronized with external devices (such as video cameras). The PD-6 automatically recognizes a video or word signal.
- “Pre Record” function, a useful feature for location recording, allows to store maximum 10-second recent audio data into the buffer. You can start recording from the current audio data in the buffer. The buffer time can be set between 1 and 10 seconds.
- A six-channel analog mixer is built in. You can make direct track recording or mix recording. For example, you can record signals of channels 1 through 4 to tracks 1 through 4 respectively, while record stereo mix (rough mix) signals to tracks 5 and 6.

- Each mixer channel provides a pan pot, a phantom power supply (P48/T12), a frequency-sweepable filter and a limiter. In addition, each of channels 2, 4 and 6 provides a phase switch.
- A 128 x 64 dot-matrix backlit LCD display for showing various information is used, which helped to design the PD-6 compact and lower power consumption. You can select the display mode by a single key operation. The level meter section can be enlarged.
- A connector conformed to IEEE1394 is provided for connecting directly to a personal computer. It allows transferring audio file data recorded by the PD-6 between the PD-6 and a personal computer.
- A USB port is provided for connecting directly to a USB keyboard. You can make setting and editing from a keyboard instead of the PD-6 panel keys. (Note that you cannot make all setting and editing from a keyboard.)
- The Cue function allows to store markers (cue points) during recording. Cue points are used for the locate or skip function. (To use cue points for the skip function, you have to set the “Skip mode” menu in the Setup mode to “CUE”.)
- The circle take function allows to put “@” to desired recorded audio files. Using this function, you can make an “OK take” list easily.
- The reference input level can be selected between -18 dB and -20 dB. (The selection is made in the Setup mode. The default setting is -20 dB.)
- Built in accurate TC generator (in +/- 1 ppm accuracy) for recording IEC time code. The time code can be started by jamming to an external time code or from the desired time of the internal clock. The jam function switches the reference from an external time code to the internal time code generator.
- The error tone can be generated for warning when disk writing error occurs, clipping occurs at the input amplifier stage, the power voltage is out of the allowable range, or the remaining space of the disk is few. (You have to make setting of the “Error tone” menu in the Setup mode appropriately.)

What is in the box

Make sure that the box contains the following. If any of them are missing, please contact your dealer.

PD-6	1
Carrying belt	1
8-centimeter DVD-RAM disk (2.8 GB)	1
Operation manual (this manual)	1

<Note>

No internal battery nor AC adaptor is supplied with the PD-6. Use an NP-1 type or equivalent for the internal battery. Use the Fostex optional AD-15C for the AC adaptor.

PD-6 options and related Fostex products

The following PD-6 options and related products are available. Ask your local Fostex dealer or sale office for details about them such as prices, specifications, etc.

Options

- External power supply unit (AC adaptor): AD-15C
- Soft case for the PD-6: ZP-6
- AATON

Related products

- DVD digital master recorder: DV40
- DAT portable digital recorder: PD-4
- DAT digital master recorder: D-15
- Personal powered monitor: 6301B/BX
- Stereo headphones: T20RP/T-5/T40RP

Chapter 2: Before using the PD-6

This chapter describes notes for the power supply and DVD-RAM disks, which you should know before using the PD-6.

<Table of contents>

About power supply	18
About battery	18
Charging the battery	18
Installing the battery	18
Removing the battery	19
Saving the battery power	19
About AC adaptor	20
Connecting the AC adaptor	20
Turning on the power	21
About power supply voltage	21
About Realtime Clock	22
About DVD-RAM disk	22
Inserting/removing a disk	23
Initial format of a disk	24
About recording modes	26

About power supply

The PD-6 is powered either by a battery which allows the unit to be used outside, or by the AC adaptor (Fostex Model AD-15C, optional).

<Note>
Make sure that the PD-6 power switch is set to “OFF” when changing a battery or when disconnect the AC adaptor from the unit. The unit continuously accesses data when the power is on, therefore, the memory contents may be reset by the sudden power interruption.

About battery

No battery is supplied with the PD-6.
We recommend to use the IDX NP-L50, IDX NP23, Sony NP-1 or equivalent for the battery of the PD-6. Typically 2-hour recording is possible using the fully charged IDX NP-L50 (note that the recordable time may vary depending on temperature or other condition).

<Note>
When charging a battery, charge to its full potential.

• Charging the battery

Normally, a battery is not charged when shipped, therefore, you must charge it before using. Refer to the instruction of the battery you purchased for details about how to charge it.

<Note>
The PD-6 does not provide the battery charging function.

• Installing the battery

Insert a battery into the battery compartment firmly from the open end on the left side panel, with the battery terminals inside, until the battery is locked.

<Note>
To run the unit on the installed battery, set the [POWER SEL] switch on the right side panel to “INT”. Also set the “warning voltage of the battery” menu in the Setup mode properly after turning on the power (see page 97 for details).

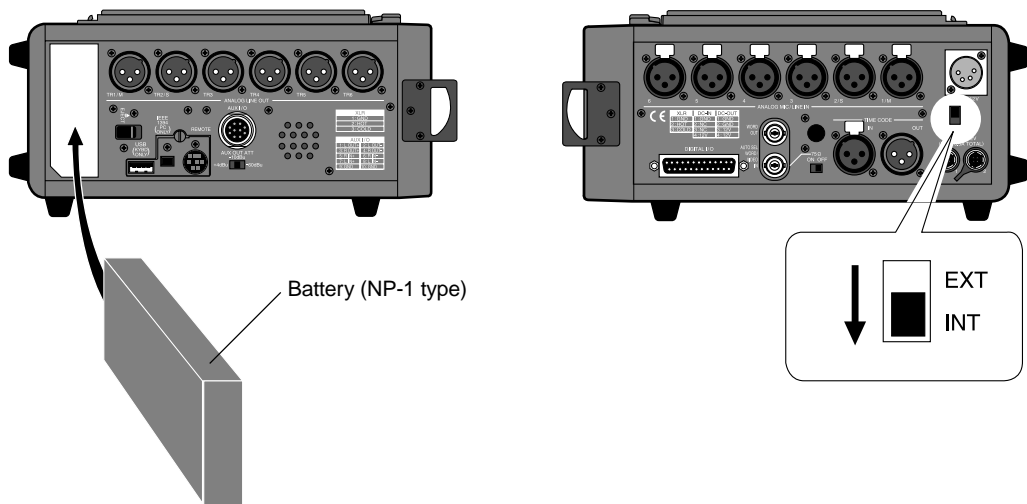

• Removing the battery

To remove the battery, set the [POWER] switch to “OFF” and slide the [EJECT] lever beside the battery compartment to the arrow direction in the figure below.

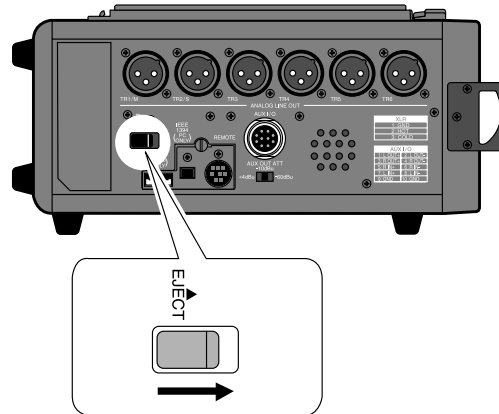

<Caution>

NiCd batteries are recyclable. When disposing a used battery, follow your local regulations regarding appropriate recycling procedures. Do not leave the removed battery within children's reach.

• Saving the battery power

The PD-6 offers the following measures for saving the battery power to extend the battery life.

- Pressing the [STOP] key stops the disk rotation to save the power consumption. It is also possible to set the desired PAUSE release time in the Setup mode (the default is three minutes).
- When the internal monitor speaker is not used (i.e. when a headphones plug is inserted to the [PHONES] jack), no power is supplied to the amplifier for the speaker.

The following describes some tips for saving the battery power, as well as some notes on using the battery.

- The input impedance of devices connected to PD-6's output connectors should be greater than 10k Ω .
- When convert a balanced output to unbalanced, do not connect the unused pin to the ground pin and leave it open. Though it lowers the output level 6dB, it does not influence to the audio characteristics.
- Set the monitor level as lower as possible (regardless of whether using headphones or the internal monitor speaker).
- When you do not operate the unit on battery power for a long period of time, remove the battery or set the [POWER SEL] switch to “EXT”.

About AC adaptor

The optional genuine AC adaptor AD-15C is available. (Contact our dealer or sale office for purchasing the AD-15C.)

<Notes>

Use only the AD-15C for an AC adaptor. Using another AC adaptor may damage the PD-6 due to the mismatch of the power voltage, polarity, etc. When connect or disconnect the AC adaptor, make sure that the [POWER] switch is set to "OFF".

• Connecting the AC adaptor

While the [POWER] switch of the PD-6 is set to "OFF", insert the XLR-4-32 type connector of the AD-15C to the [DC IN] connector on the right side panel of the PD-6 until it is locked. Then connect the AC plug to the AC main outlet.

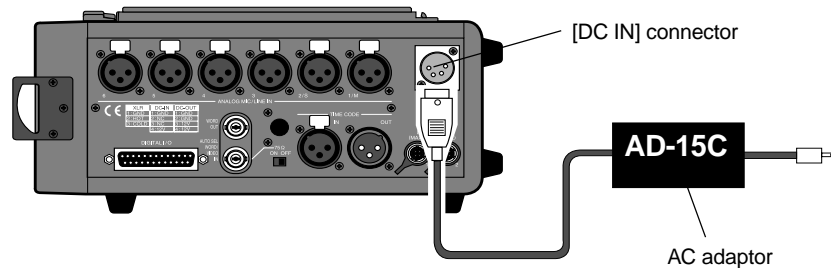

<Note>

When using an external power supply such as the AC adaptor, set the [POWER SEL] switch under the [DC IN] connector to the "EXT" position.

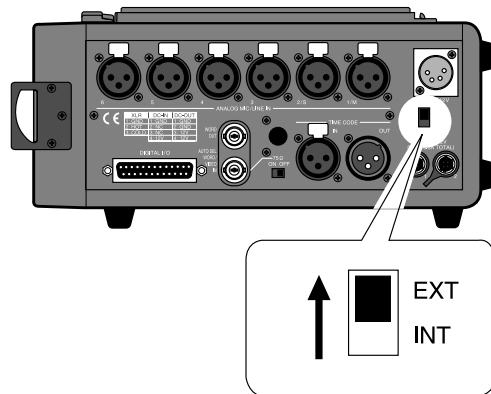

<Note>

While operating the PD-6 with an external power supply (AC adaptor or external battery), you can change the AC main outlet connected to the adaptor or replace the external power supply without TC interruption if the fully charged NP-1 type is installed to the PD-6. See below for the procedure.

- 1) Make sure that the fully charged battery is installed to the PD-6.
- 2) Set the [POWER SEL] switch to "INT" from "EXT".
- 3) Change the AC main outlet connected to the adaptor or replace the external power supply.
- 4) Set the [POWER SEL] switch to "EXT" from "INT".

Turning on the power

When switch the [POWER] switch to “ON” after fitting the internal battery or connecting the AC adaptor (AD-15C), the PD-6 works as follows.

If you turn on the power while no disk is inserted, the PD-6 releases the door lock after recognizing that no disk is inserted, and shows “— Unlock door —” is shown in the file name field on the LCD screen.

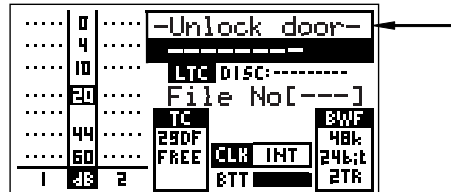

<Note>

The level, TC and Fs fields of the LCD screen show the settings according to the switch positions when turning off the power last time. See “Display section” in “Chapter 3: Names and Functions” for details.

About power supply voltage

The output voltage of the power supply for the PD-6 must be within the range between DC 12 to 18 volts. Never use the PD-6 at more than 18 volts or less than 12 volts. You can check the internal battery voltage on the display (indicated by the arrow in the screen example below).

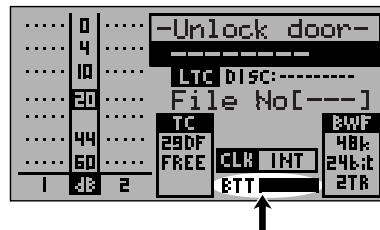

The current battery voltage is shown in the dotted bar meter.

Each dot corresponds to approximately 0.2 V. When the battery voltage is less than 10.4 V, all dots are unlit. When it is 14.0 V or more, all dots are lit. Note that the battery life depends on the battery. The Also note that it fully lights when the AC adaptor is used.

The PD-6 has the facility for sounding the warning tone from the internal monitor speaker (or headphones) when the supplied voltage of the battery or the external power supply voltage becomes improper.

<Notes>

- You can make the setting for generating the warning tone by the “Error tone” menu in the Setup mode. See “Setup mode” on page 96 for details.
- If the power supply voltage exceeds 18 volts, the PD-6 may be damaged. Never supply more than 18 volts to the PD-6.
- If the battery is dead or the power supply section has a trouble by surge current, etc., the protection circuit works and the power is shut off. In such a case, set the [POWER] switch to “OFF”, replace the battery with a charged one, then set the [POWER] switch to “ON” again.
If the PD-6 does not return to the normal condition after the operation above, there may be some trouble in the circuit.

About Realtime Clock

The PD-6 offers realtime clock function.

The realtime clock data is used for a file name (date and time when the file is created) when creating a new audio file on a disk, the time code start time when recording a time code by the internal time code generator, and so on.

The realtime clock is adjusted according to the local time when shipped, therefore, set the time to your local time before using the PD-6 (see “Chapter 7: Setup mode” on page 90 for details about realtime clock setting).

<Notes>

- When shipped, the file name mode is set to “DATE”, therefore, the realtime clock data is automatically used as the name of an audio file name created when recording. You can edit the file name later. See “Chapter 7: Setup mode” on page 99 for details about file name editing and file name mode setting.

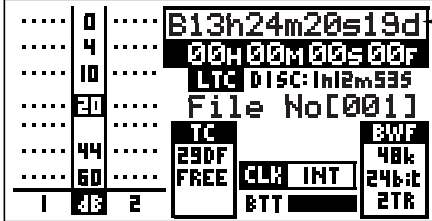

← file name

- Only when the TC GEN mode is set to “24H RUN”, the realtime clock data is used as the TC start time (see “Recording/playback” on page 72 for details about the TC GEN mode).

About DVD-RAM disk

The PD-6 uses MAXELL 8-centimeter DVD-RAM (double sided) disks shown below. You can record data to both sides A and B. The arrows below show the direction for insertion.



<Side A>

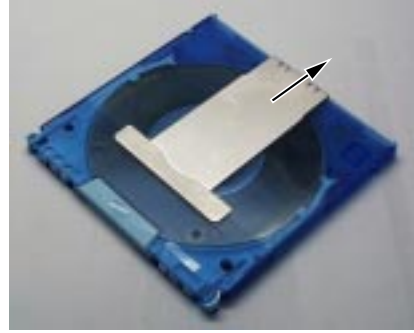

<Side B>

Inserting / removing a disk

You can insert or remove a disk regardless of whether the power is on or off, however, the procedure below is assumed that the power is on.

- 1) Slide the [OPEN] lever right and open the protection cover manually.
- 2) Press the [DISC UNLOCK] button to release the tray lock.
- 3) Slide the [EJECT] lever to open the tray.
- 4) Set (or remove) a DVD-RAM disk to (or from) the tray and press the upper part of the tray to close the tray.

If you set an unused disk, the display shows the screen for prompting disk formatting.

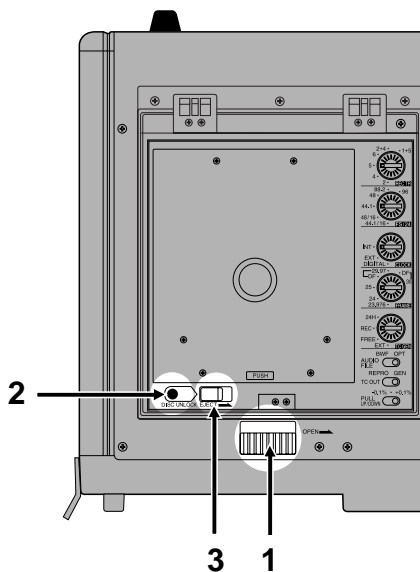

<Note>

When inserting a disk to the tray, make sure that the direction is right.

<Note>

Depending on the condition when you turned off the power last time, the disk lock may not be released on rare occasions. In such a case, turn off and on the power, then press the [DISC UNLOCK] button again to release the disk lock.

<Notes>

When setting an unused new disk, the message as shown in <Figure 1> appears after reading the disk information, prompting that disk formatting is required.

An unused disk may not be formatted with the UDF format Rev 1.5 or may not have the BWF directory, therefore, it must be formatted with UDF Rev1.5 format.

When an unformatted disk or a disk which is not formatted in UDF format is set, the PD-6 automatically brings up the "Format" menu (see <Figure 2>) in the Utility mode after reading the disk information. This shows the disk is not UDF-formatted and must be formatted with UDF Rev1.5.

If you do not format the disk, press the [EXIT] key. The PD-6 releases the disk from locking so that you can remove the disk from the tray.

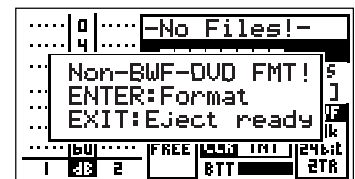

<Figure-1>

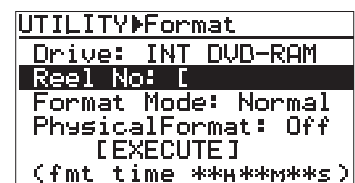

<Figure-2>

Initial format of a disk

The operation procedure below is assumed that an unused DVD-RAM disk is set to the PD-6. If you have a disk formatted with FAT32, etc., you can format it with the similar procedure.

- 1) **While the message “Non-BWF-DVD FMT!” is shown, press the [ENTER] key.**
 The PD-6 automatically enters the “Format” menu.
 When an unused disk is set, the Reel No field is blank and you have to enter a desired reel number.

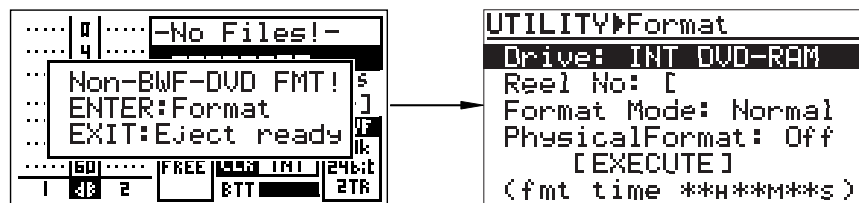

- 2) **Select “Reel No” using the [SEL] dial and press the [ENTER] key.**
 The leftmost digit of the Reel No field starts flashing, showing that now you can enter a reel number.

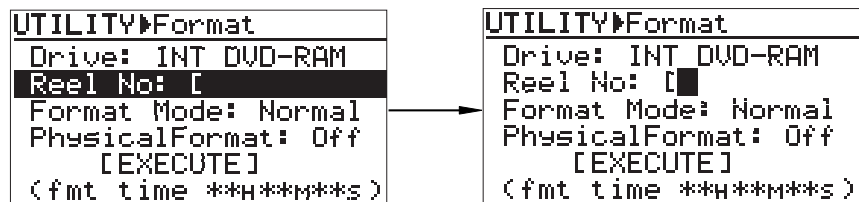

- 3) **Enter a desired reel number using the [SEL] dial (or the numeric keys).**
 For example, you can enter “S001”.
 Use the [◀ SKIP/CURSOR ▶] keys to move the cursor position.
 When using the numeric keys for entering characters, pressing any other numeric key moves the cursor to the right automatically.

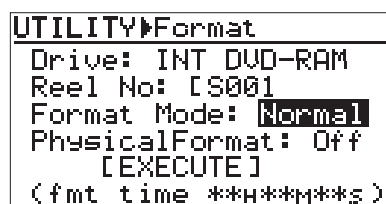

<Note>
 There are two options for the Format mode: “Normal” and “Tape”.
 With a disk formatted in the “Normal” mode, each time you make recording, a new audio file is automatically created.
 Meanwhile, when formatting a disk in the “Tape” mode, the whole disk is formatted as a single file. In other words, a “Tape mode” audio file is created on a disk.
 For details about how to format a disk in the “Tape” mode, see “Formatting a disk” in “Chapter 8: Utility mode” on page 115.

- 5) Press the [ENTER] key twice to highlight “[EXECUTE]” and press the [ENTER] key again.

The display changes to show the caution message, in which “Are you sure?” flashes.

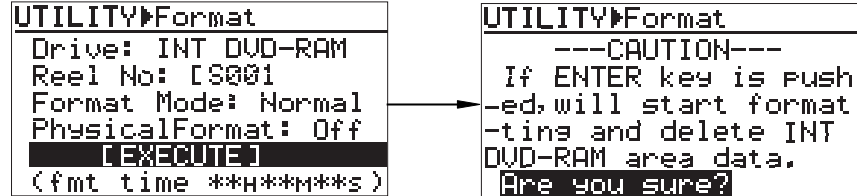

- 6) Press the [ENTER] key.

Formatting starts.

The display now shows the approximate time required for formatting, as well as the bar-graph meter which shows the progress.

When formatting finishes, “Fmt. Completed!” is shown.

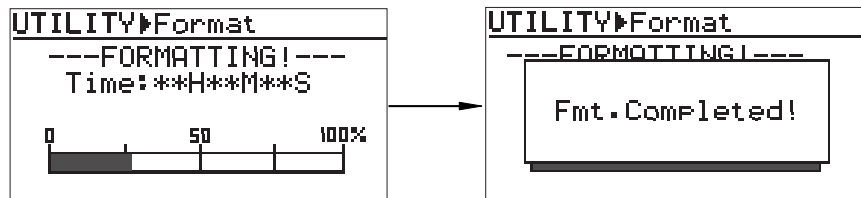

- 7) Press the [EXIT] key to exit the Utility mode.

The display changes to show the normal screen, on which “No Files!” is shown in the file name field.

The disk is now formatted with UDF Rev1.5 and you can make recording or playback.

The level, TC and BWF sections on the screen show the status according to the [REC TR], [FS/24] and [FRAME] switch positions when formatting started.

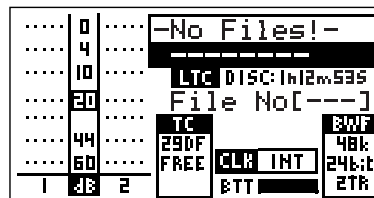

- 8) Format disk side B with the same procedure as above.

<Note>

On rare occasions, “Disk error!” appears on the display and the disk lock is released after formatting is completed. In such a case, set “Physical format” to “ON” in the “Format” menu and format the disk again (see “Format menu” in “Chapter 8: Utility mode” on page 115 for details about the physical format).

If “Disk error!” appears again after carrying out physical format, do not use the disk.

About recording modes

With a disk formatted in the UDF Rev1.5 “Normal” mode, you can make recording in the “One file mode” or “Two file mode”, which can be selected by the [REC TR] select switch.

If you set the [REC TR] select switch to 2, 4, 5 or 6, recording is made by the “One file mode”, in which a single audio file is created when recording starts. See the figure on the right.

In the “One file mode”, each time recording is made, a new audio file with the incremented number is created.

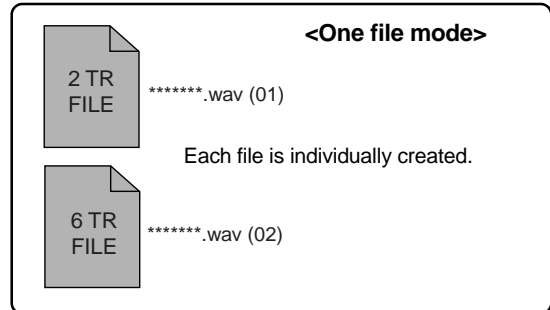

If you set the [REC TR] select switch to 2+4 or 1+5, recording is made by the “Two file mode”, in which two audio files (two-track and four-track files, or one-track and five-track files) are created when recording starts.

In the “Two file mode”, two new audio file with the successive numbers are simultaneously created, in which the file with the smaller number is the multitrack file and “M” is added to the file name.

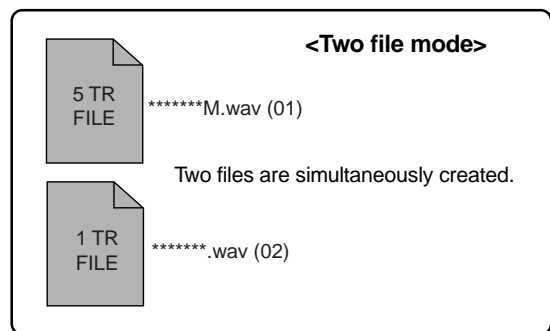

<Note>
If a disk is formatted in the “Tape” mode, You cannot make recording in the “Two file mode”.

<Note>
The position of “M” added to a multitrack file name depends on the “File name mode” setting in the “Default file name” menu of the Setup mode. See “Chapter 5: Recording/playback” on page 68 for details.

With a disk formatted in the “Normal” or “Tape” mode, files are stored in the “BWF” directory. An 8-centimeter DVD-RAM disk allows recording to both sides, so you can make recording in the “Normal” mode on side A, while in the “Tape” mode on side B. For details about how to format a disk in the “Tape” mode, see “Formatting a disk” in “Chapter 8: Utility mode” on page 115.

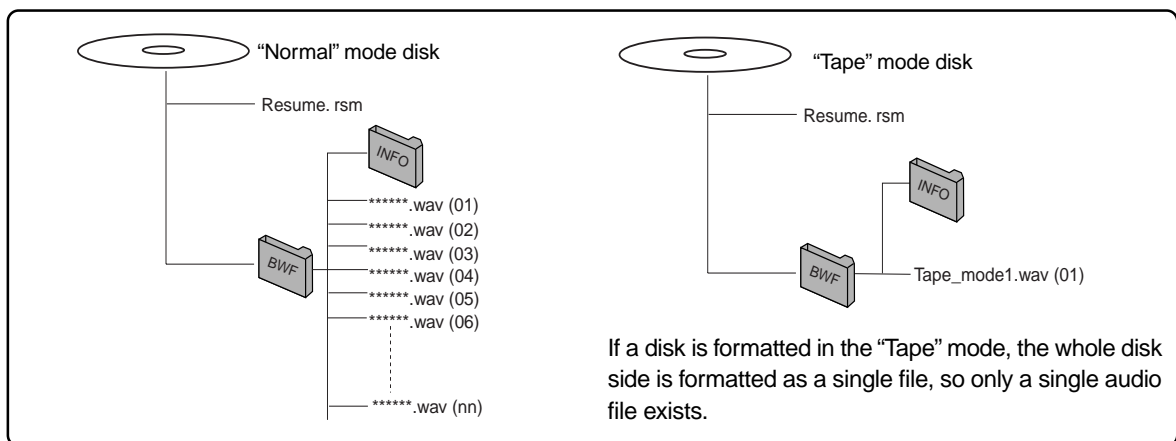

Chapter 3: Names and functions

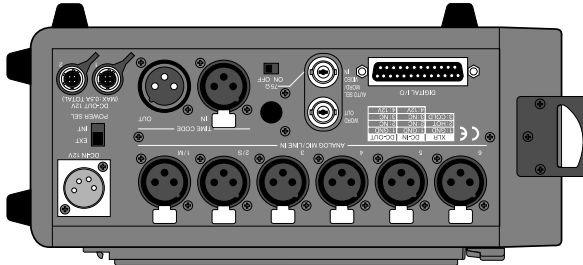

<Right side panel section>

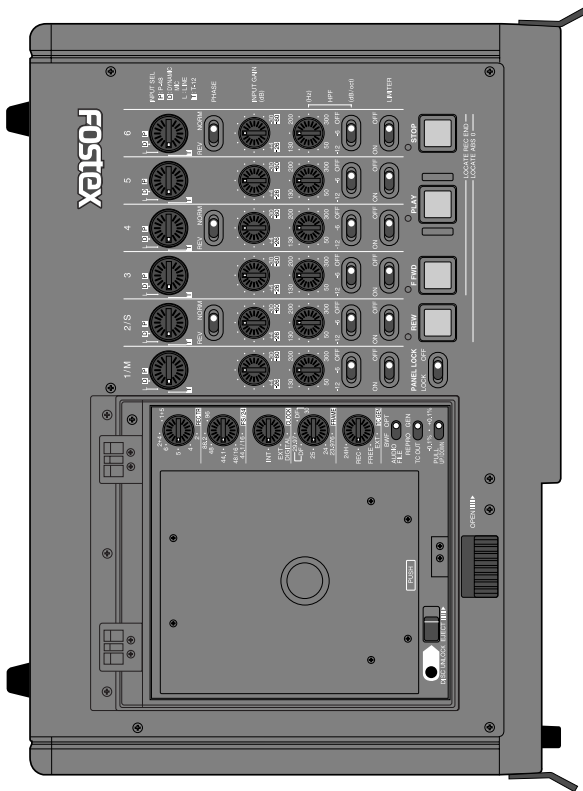

<Top panel section>

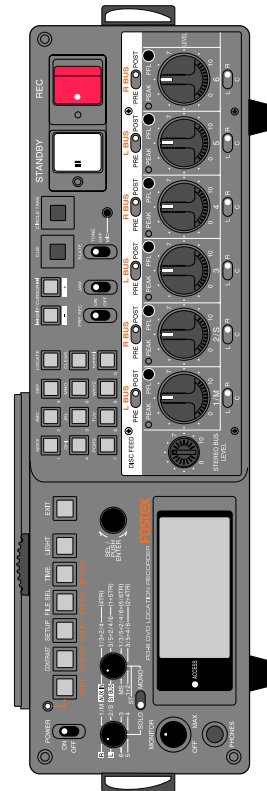

<Front panel section>

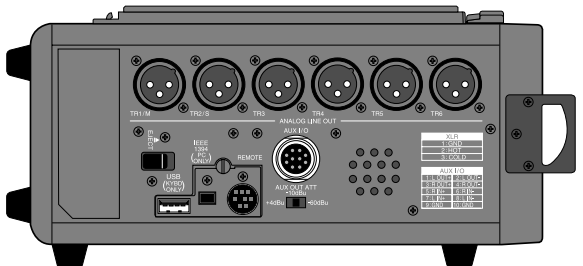

<Left side panel section>

Left side panel (Inputs/outputs)

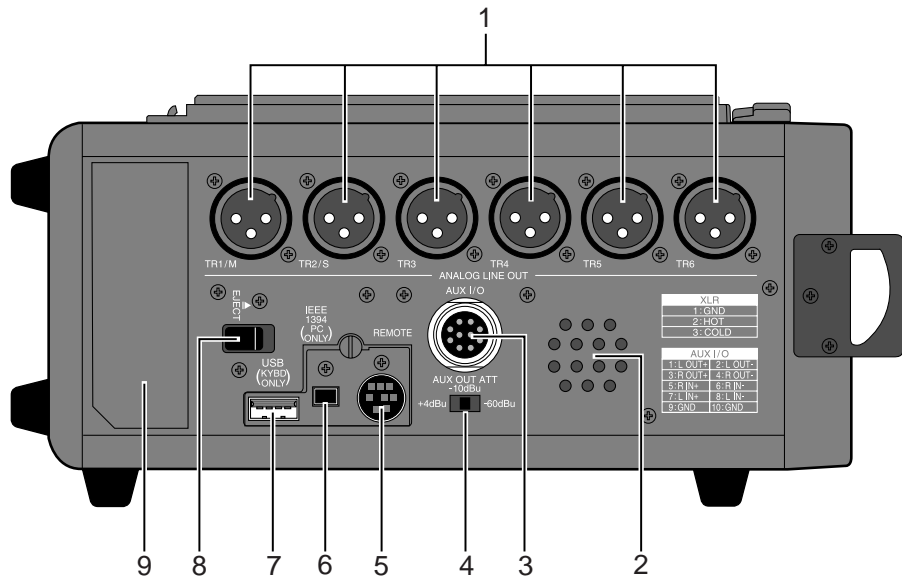

1. [ANALOG LINE OUT] connectors

These connectors feed analog audio signals of tracks 1 through 6.
Connectors: XLR-3-32 type (balanced)

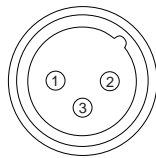

1	GND
2	HOT
3	COLD

2. Internal monitor speaker

Outputs track audio signals, error tones, etc.
When a headphones plug is inserted to the [PHONES] jack, the monitor speaker is inactive.

3. [AUX I/O] connector

The input ports of the [AUX I/O] connector receive audio signals and route them to the monitor circuit, while the output ports feed stereo buss signals. You can select the output level from among three options using the [AUX OUT ATT] switch.

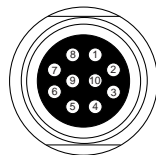

1	L OUT +	6	R IN -
2	L OUT -	7	L IN +
3	R OUT +	8	L IN -
4	R OUT -	9	GND
5	R IN +	10	GND

4. [AUX OUT ATT] switch

Switches the output level of signals sent from the output ports of the [AUX I/O] connector among +4 dBu, -10 dBu and -60 dBu.

5. [REMOTE] connector

This connector accepts parallel remote signals for controlling the PD-6 externally. Connector: MINI DIN 8-pin
 You can control the following nine operations remotely.

1	PLAY	6	CUE point registration
2	STOP	7	PAUSE
3	RECORD	8	SKIP/CURSOR ◀◀
4	REWIND	9	SKIP/CURSOR ▶▶
5	F.FORWARD		

<Operation>

When a terminal is grounded, the function is active.

Note that you can always control the PD-6 via this connector regardless of the setting of the [PANEL LOCK] key on the panel.

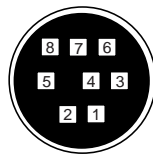

1	PLAY
2	STOP
3	REC
4	GND
5	SHIFT
6	REW
7	VBATT *
8	FF

SHIFT + STOP	CUE
SHIFT + REC	PAUSE
SHIFT + REW	SKIP/CURSOR ◀◀
SHIFT + FF	SKIP/CURSOR ▶▶

(*) V BATT (12 - 24 V). Max 500 mA.
 This pin always supplies the voltage regardless of whether the [POWER] switch is set to "ON" or "OFF". (delivers a voltage regardless of the [POWER] switch setting.)

<Caution>

Pin 7 (DC 12V) supplies the PD-6 operation voltage. If it is short-circuited to GND, or use it with a heavy load, the PD-6 internal battery life may be exhausted faster or the PD-6 may generate heat abnormally.
 Be careful not to use it with a heavy load or short-circuit it to GND.

6. [IEEE1394] connector

Exclusively used to connect to a PC, allowing you to transfer audio files between the PD-6 and the PC.

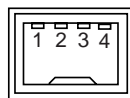

1	TPB -
2	TPB +
3	TPA -
4	TPA +

7. [USB] connector

Used to connect to a USB keyboard, allowing you to control the PD-6 from the keyboard (see "Operation from a keyboard" on page 54).

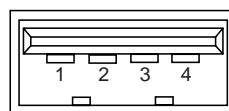

1	VBUS
2	D -
3	D +
4	GND

8. [EJECT] lever

Used to remove the internal battery (NP-1 type) from the battery compartment.

9. Battery compartment

Stores the battery (NP-1 type).

Right side panel (Inputs/outputs)

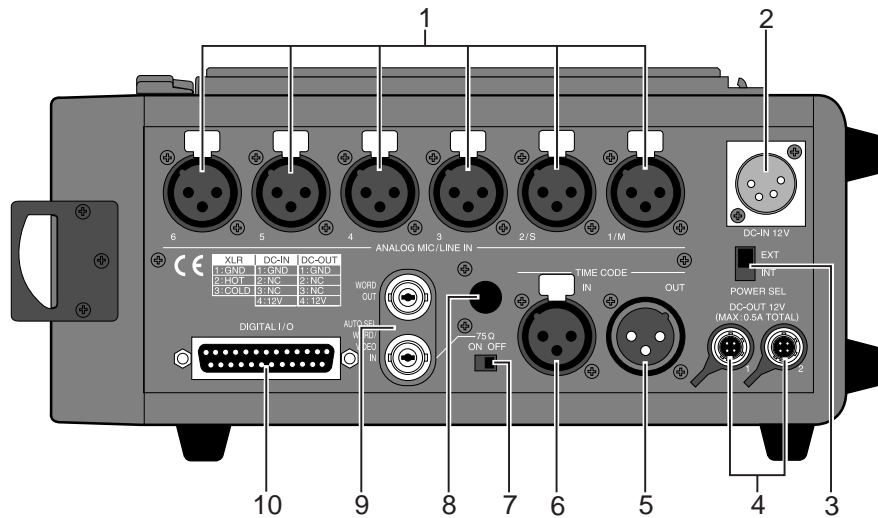

1. **[ANALOG MIC/LINE INPUT] connectors**
 These connectors receive analog audio signals (mic or line level), which can be sources of channels 1 through 6.
 Connectors: XLR-3-31 type (balanced)

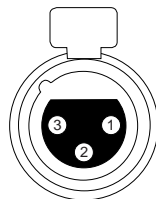

1	GND
2	HOT
3	COLD

2. **[DC IN 12V] connector**
 Connects the AC adaptor (Model AD-15C) or an external battery.
 Connector: XLR-4-32 type

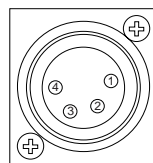

1	GND
2	NC
3	NC
4	12V

3. **[POWER SEL (INT/EXT)] switch**
 Selects the power supply source for the PD-6.
 When "INT" is selected, the PD-6 runs with the internal battery (NP-1 type).
 When "EXT" is selected, it runs with an external power supply.

4. **[DC OUT] connectors**
 Each connector outputs DC 12 V power. You can supply power to up to two external devices.

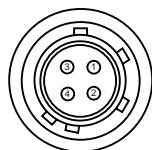

1	GND
2	NC
3	NC
4	12V

5. [TIME CODE OUT] connector

Outputs time code. Connector: XLR-3-32 type (balanced)

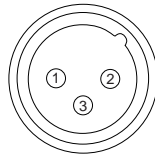

1	GND
2	HOT
3	COLD

6. [TIME CODE IN] connector

Inputs external time code. Connector: XLR-3-31 type (balanced)

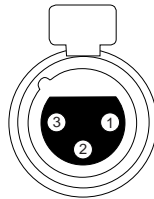

1	GND
2	HOT
3	COLD

7. [WORD IN] terminate switch

Terminates the word input signal by setting the switch to “ON”.

8. (Blank cap for installing the option)

This part is reserved for installing the optional AATON.

9. [WORD/VIDEO IN]/[WORD OUT] connectors

The [WORD/VIDEO IN] connector receives word or video clock. It automatically detects the clock type (word or video).

The [WORD OUT] connector feeds a word clock. Connectors: BNC type

10. [DIGITAL I/O] connector

Receives and feeds AES/EBU or S/P DIF digital signals.

Connector: 25-pin D-sub connector

You can make AES/EBU or S/P DIF selection using the menu in the Setup mode.

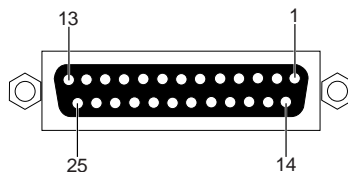

Signal	Hot	Cold	Terminal treatment
Input 1/2	1	14	
Input 3/4	2	15	
Input 5/6	3	16	
Input 7/8	4	17	Open
Output 1/2	5	18	
Output 3/4	6	19	
Output 5/6	7	20	
Output 7/8	8	21	GND
Frame GND	10, 12, 13, 22, 23, 24, 25		
Open	9, 11		

- The pin assignment is compatible with the 25-pin D-sub connectors provide on the Fostex 8350 and Yamaha equipment.
- Recommended connection cable:
DBK-258, DB-25 (M), TO 4XLR (M), AND 4XLR (F), 5M (16.5FT.)
AES/EBU DIGITAL AUDIO TRANSFER CABLE
HOSA TECHNOLOGY,INC.

Front panel (part 1)

We divide the front panel into three parts and describe names and functions of controls for each section.

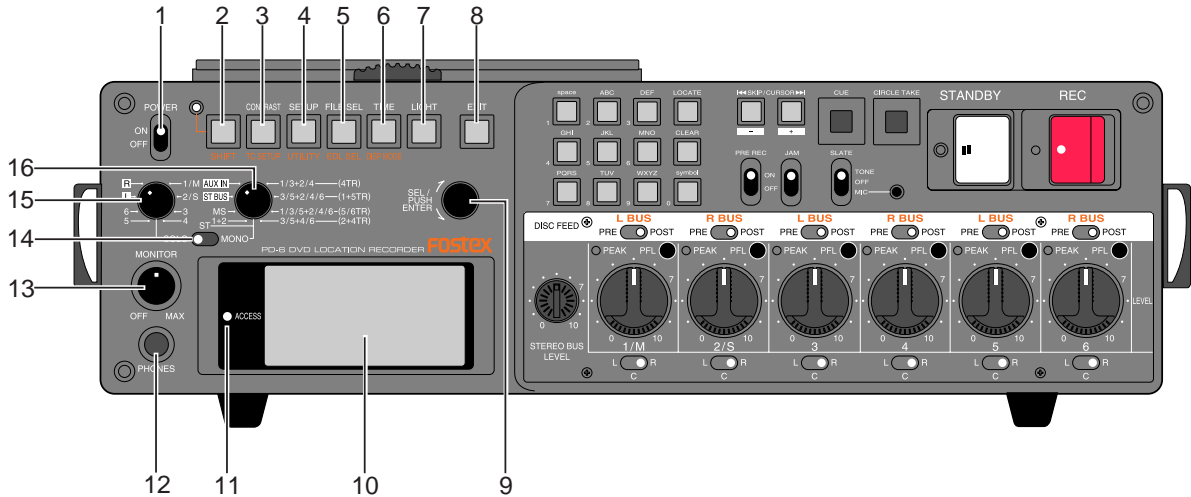

* Some keys have the secondary function which is available when the SHIFT indicator is lit, while the primary function is available when the SHIFT indicator is unlit. In this manual, we sometimes say “when SHIFTed” and “when unSHIFTed” instead of “when the SHIFT indicator is lit” and “when the SHIFT indicator is unlit” respectively.

1. [POWER] switch

Turns on or off the main power of the PD-6.
The switch is fitted back from the panel surface in order not to switch it accidentally.

<Note>

If the [PANEL LOCK] switch is set to the “LOCK” position, you cannot turn off the power.

2. [SHIFT] key/indicator

This key makes the shift mode active (the indicator is lit) or inactive (the indicator is unlit). If you press a key which provides its SHIFTed function while the shift mode is active, the PD-6 goes into the SHIFTed function which is labeled under the key. To enter to another mode, press the [EXIT] key to quit the mode and carry out the same procedure.

<Example>

By pressing the [CONTRAST/TC SETUP] key while the shift mode is active, you can make settings for recording/playback time code.

3. [CONTRAST/TC SETUP] key

This key has primary (unSHIFTed) and secondary (SHIFTed) functions.

• When unSHIFTed:

By pressing this key, you can adjust the display contrast using the [SEL] dial. After adjusting the contrast, pressing the [ENTER] key stores the setting.

• When SHIFTed:

Activates the TC Setup mode, in which you can make the necessary settings for recording and playing back time code (see page 81). To exit the TC Setup mode, press the [EXIT] key.

4. [SETUP/UTILITY] key

This key has primary (unSHIFTed) and secondary (SHIFTed) functions.

•When unSHIFTed:

Enters the Setup mode in which you can make settings for the preferences (see page 87). To exit from the Setup mode, press the [EXIT] key.

•When SHIFTed:

Enters the Utility mode in which you can make settings related with disks (see page 105). To exit from the Utility mode, press the [EXIT] key.

5. [FILE SEL/EDL SEL] key

This key has primary (unSHIFTed) and secondary (SHIFTed) functions.

•When unSHIFTed:

By pressing this key, you can select an audio file from among the files recorded on the current disk using the [SEL] dial (see page 77). After selecting the file, pressing the [ENTER] key to confirm the setting.

•When SHIFTed:

Enters the EDL SEL mode. In this mode, you can create and edit an ALE file which should be registered during recording (see page 123). To exit from the EDL SEL mode, press the [EXIT] key.

6. [TIME/DISP MODE] key

This key has primary (unSHIFTed) and secondary (SHIFTed) functions.

•When unSHIFTed:

Selects the time display mode from among ABS, LTC, TC IN and GEN.

•When SHIFTed:

Switches to the mode in which you can enlarge the level display section on the screen (see page 44).

7. [LIGHT] key

Used to turn on the LCD backlight.

By pressing the key instantly, the LCD backlight turns on for approximately three seconds and then automatically turns off.

By pressing the key for more than three seconds, the backlight continues to light up until pressing the key again.

<Note>

While operating the PD-6 with the internal battery, we recommend not to turn on the backlight unless it is needed.

8. [EXIT] key

Used to cancel edit operation or execution, as well as used to exit the setup or Utility mode.

9. [SEL] dial/[ENTER] key

The [SEL] dial is used to select a menu or enter characters in the Setup mode and other editing modes.

The [ENTER] key confirms setting or executes the selected operation.

10. LCD display

Displays audio input/output levels, settings, menus, etc. (see page 43).

11. **[ACCESS] indicator**
Indicates the access condition of a DVD-RAM disk.
It lights in green while it is not accessed, in orange while it is accessed for reading, and in red while it is accessed for writing.
12. **[PHONES] jack**
Connects headphones.
Inserting a plug automatically disables the internal monitor speaker.
13. **[MONITOR] control**
Adjusts the monitor level of headphones and the internal monitor speaker.
Each press of the control pushes down the control to the same level as the panel or pulls it up.
Turning the control counterclockwise until clicked turns off the monitor sound.
14. **SOLO monitor select switch**
When the monitor mode select switch (see below) is set to “SOLO”, this switch selects the monitor signal from among any one of the input channel signals (1/M, 2/S, 3 through 6) or either of the stereo buss signals (L or R). Note that, when the monitor mode select switch is not set to “SOLO”, this switch is not effective.
15. **Monitor mode select switch**
Selects the monitor mode from among the following.

SOLO	Monitors singles selected by the SOLO monitor select switch.
ST	Monitors signals selected by the ST/MONO monitor select switch in stereo.
MONO	Monitors signals selected by the ST/MONO monitor select switch in mono.
16. **ST/MONO monitor select switch**
When the monitor mode select switch is set to “MONO” or “ST”, this switch selects the tracks/input channels to be monitored. Note that, when the monitor mode select switch is set to “SOLO”, this switch is not effective.

Front panel (part 2)

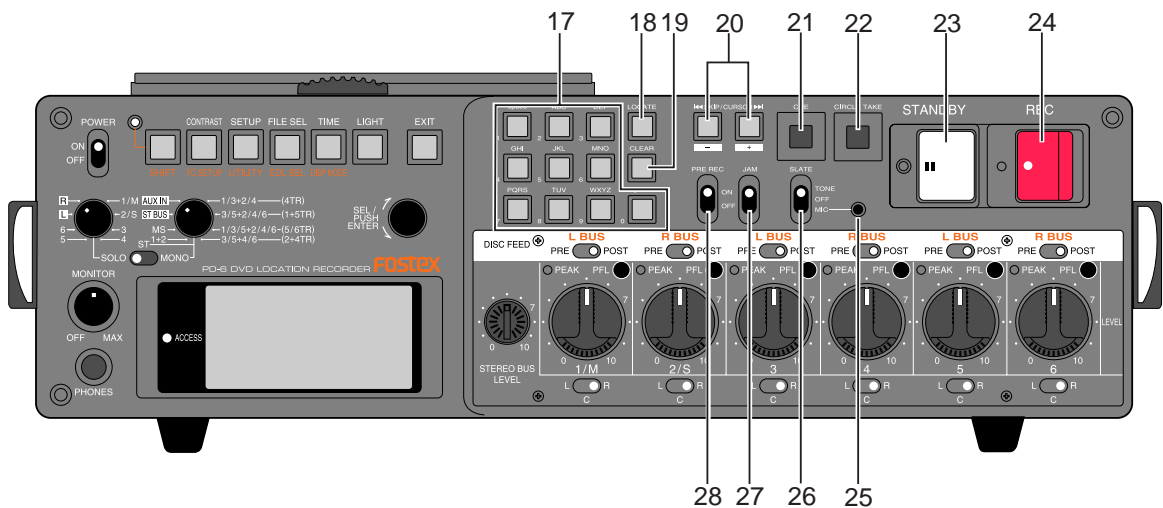

17. Alphanumeric keys

While the display shows the normal screen, pressing any of the numeric keys enters the time data edit mode. After editing time data, you can locate to the edited time position (see page 78). While the PD-6 is in any of the edit modes, you can enter time data or name.

<Key example>

Using the “3” key, you can enter “d”, “e”, “f”, “D”, “E” and “F”, as well as “3”.

18. [LOCATE] key

Locates to the desired position in the following manners.

- 1) While a cue point is selected, pressing the key locates to the selected cue point (see page 79).
- 2) While time data is edited, pressing the key locates to the edited time position (see page 79).
- 3) While the display shows the normal screen, pressing the key locates to the previously located point (the default setting is “ABS 0”).

19. [CLEAR] key

Pressing this key functions as follows.

- 1) While entering characters:
Erases the next character on the right of the cursor position.
- 2) While editing time data:
Clears time data and sets it to “00h 00m 00f 00sf”.
- 3) While the “Peak hold” setting menu in the Setup mode is set to “∞”:
Resets the peak level indication on the level meters.

20. [◀◀ SKIP/CURSOR ▶▶] keys

These keys function as follows.

- 1) While the display shows the normal screen and the skip mode is set to “File”:
Pressing the ◀◀ (or ▶▶) key skips to “ABS 0” of the previous (or next) audio file. You can skip to “ABS 0” of the desired audio file by pressing the appropriate key as many times as required.
- 2) While the display shows the normal screen and the skip mode is set to “Cue”:
Pressing the ◀◀ (or ▶▶) key skips to the previous (or next) cue point. You can skip to the desired cue point by pressing the appropriate key as many times as required.
- 3) While editing time or a label in the edit mode:
Pressing the ◀◀ (or ▶▶) key moves the cursor to right (or left).

21. [CUE] key

This key functions as follows depending on the recorder condition.

- During recording:
By pressing this key during recording, the current position data is stored as a cue point “on the fly”.
The data is entered into the next available cue point (see page 73).
- In any condition except during recording:
Pressing this key brings up the cue point list, where you can check the cue points which hold data. You can also locate to the desired cue point, edit the cue point data and performs cue point entry (see page 73).

22. [CIRCLE TAKE] key

Adds “@” to the beginning of the name of the current audio file. If the name of the current audio file already has “@” at the beginning, pressing this key deletes “@”.

23. [STANDBY] key/indicator (green)

During recording or playback, pressing this key pauses the recorder and lights up the [STANDBY] indicator. Only this key can stop recording. You cannot stop recording with any other key. You can set the pause release time using the “Pause time” menu in the Setup mode (see page 95).

This key also can be used to clear an unsuccessful audio file you made last time. By pressing the [STANDBY] key while holding down the [CLEAR] key and then pressing the [ENTER] key, the last recording is canceled and the audio file is cleared. (See page 66 for details.)

24. [REC] key/indicator (red)

Pressing this key starts recording. Depending on the file format type (Normal or Tape) and “PRE REC mode” setting (on or off), it works as follows.

- 1) **When recording to a disk formatted in the Normal mode:**
Pressing this key automatically creates a new file and starts audio and time code recording. The offset between the time code and ABS time values after a second from the beginning of recording is also recorded.
- 2) **When recording to a disk formatted in the Tape mode:**
Pressing this key starts recording onto the current file from the current position.
- 3) **When recording with the PRE REC mode set to “ON”:**
Pressing this key starts recording from the audio data stored in the buffer. The offset between the time code and ABS time values after a second from the beginning of recording is also recorded.
You can select the buffered time among 1 and 10 seconds using the menu in the Setup mode (the default setting is 10 seconds).

<Note>
The recorded time code depends on the [TC GEN] select switch setting.

25. Slate microphone

This internal slate microphone is active while you slide the [SLATE] switch knob to the “MIC” position. The microphone level is automatically controlled by AGC (Automatic Gain Control).

26. [SLATE] switch

While sliding the switch knob to the [TONE] position, the slate tone is output. While sliding the knob to the [SLATE] position, the internal slate microphone is active.

TONE	While sliding the switch knob to the [TONE] position, the slate tone (at 1 kHz, reference level) is fed to all tracks and stereo busses. During recording, you can record the slate tone.
MIC	The slate microphone signal is fed to all tracks and stereo busses. By sliding the switch knob to the [MIC] position during recording, you can record the slate microphone signal.

27. [JAM] switch

Used to execute the jamming function (see page 72).
 When this switch is set to “ON” and the PD-6 is receiving external time code, the internal time code generator takes over (jams) time code. Note that the jamming function is only available when the [TC GEN] mode switch is set to “FREE RUN”. Depending on the “JAM mode” menu setting in the TC Setup mode, the PD-6 jams the time code user bits regardless of the [TC GEN] mode switch setting.

28. [PRE REC] switch

When this switch is set to “ON”, recording starts from audio data stored in the buffer. The buffered time can be set using the “Pre rec time” menu in the Setup mode (see “Setup mode” on page 101).

Front panel (part 2)

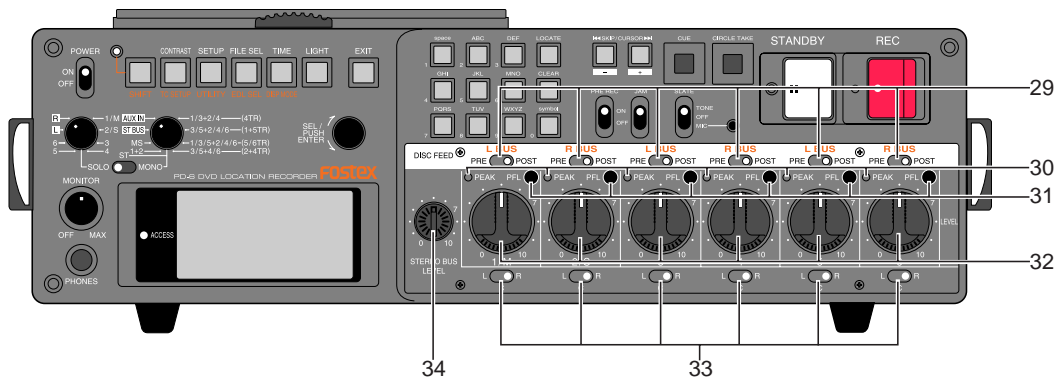

29. [DISC FEED] switches

Each switch selects a recording source of corresponding track.

PRE	Channel pre-fader signal is selected.
L BUS R BUS	Stereo buss (L or R) signal is selected. The “L” signal can be assigned to the odd tracks, while the “R” signal can be assigned to the even tracks.
POST	Channel post-fader signal is selected.

30. [PEAK] indicators

Each indicator lights up according to the input level of the input amplifier.
 Lights in green: The input level is between -1 dB and -5 dB of the clipping level.
 Lights in red: The input level is between 0 dB and -1 dB of the clipping level.
 By setting “Input Clip” in the “Error tone” menu of the Setup mode to “On”, the error tone is output from the monitor speaker (or headphones) whenever the corresponding input channel receives a loud signal which makes the indicator lit in red (see “Setup mode” on page 96).

31. [PFL] keys

By pressing a [PFL] key, you can hear the pre-fader signal of the corresponding channel from the internal monitor speaker or headphones.
 When any of the [PFL] keys is pressed, the pre-fader signal takes priority to the signal selected by the monitor selection switches (SOLO monitor select switch, Monitor mode select switch and ST/MONO monitor select switch).

32. [LEVEL] controls

Each control adjusts the analog input level of the corresponding channel (1 to 6). You can control the signal level sent to the stereo buss. When the [DISC FEED] switch is set to "POST", the [LEVEL] controlled signal is sent to the corresponding track.

33. [PAN] switches

Each switch sets pan for sending the channel signal to the stereo buss.

34. [STEREO BUS LEVEL] control

Adjusts the stereo buss master level.

Top panel (part 1)

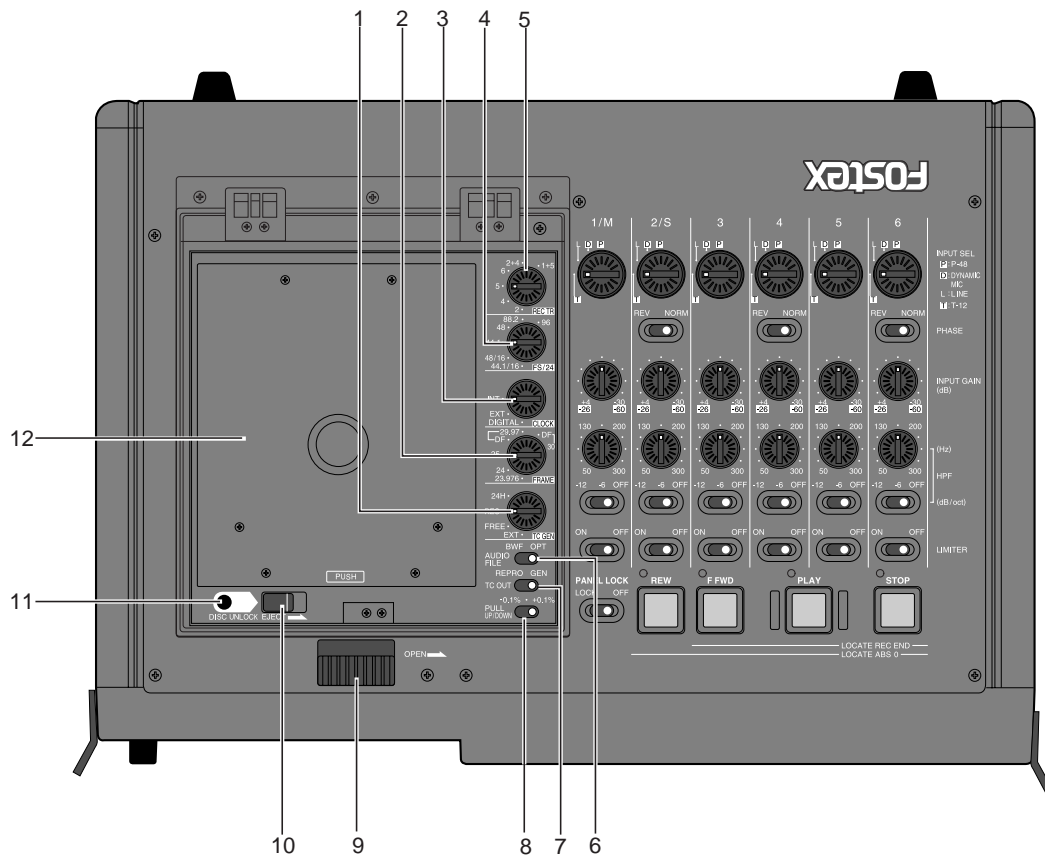

1. [TC GEN] switch

Selects the generator mode for time code recording.

EXT (Ext Run)	Records an incoming external time code value as the start time.
FREE (Free Run)	Runs the internal generator by the free run mode, and records the current internal generator time as the start time.
REC (Rec Run)	When recording to a new file, the generator records time code from the value which continues to the last time code value of the previous audio file.
24H (24H Run)	Time code starts from the internal RTC (real-time clock) data.

<Note>
See "Recording/playback" on page 70 for details about time code recording/playback.

2. [FRAME] switch

Selects the time code frame rate for recording, playback and generation by the internal TC generator.

23.976	American motion picture -0.1%
24	American motion picture
25	European film/PAL-SECAM video EBU
29.97DF	NTSC color with real time adjust
29.97	NTSC color
30DF	NTSC video/film
30	NTSC video/film

3. [CLOCK] switch

Selects the system master clock.

INT	The internal clock is the master. "INT" is lit on the display.
EXT	The external word or video clock is the master. "EXT" is lit on the display. The PD-6 automatically detects the clock type (word or video). When the PD-6 locks to a word clock, "WORD" is lit. When it locks to a video clock, "VIDEO" is lit. When it does not lock to the clock, "WORD" or "VIDEO" flashes and it runs with the internal clock reference.
DIGITAL	The external clock available in the external digital signal is the master. "DIGI" is lit on the display. When the PD-6 locks to a clock, "DIGITAL" is also lit on the display. When it does not lock to the clock, "DIGITAL" flashes and it runs with the internal clock reference.

4. [FS/24] switch

Selects the Fs (sampling frequency) and Bit (quantization bit) for recording. Depending on the setting, the available recording track modes change as follows.

		REC TR					
		2	4	5	6	2+4	1+5
FS/24 SW	44.1/16	Yes	Yes	Yes	Yes	Yes	Yes
	48/16	Yes	Yes	Yes	Yes	Yes	Yes
	44.1/24	Yes	Yes	Yes	Yes	Yes	Yes
	48/24	Yes	Yes	Yes	Yes	Yes	Yes
	88.2/24	Yes	No	No	No	No	No
	96/24	Yes	No	No	No	No	No

5. [REC TR] select switch

Selects the recording track mode from among the following.

2TR	You can record to a stereo-track file.
4TR	You can record to a four-track file.
5TR	You can record to a five-track file.
6TR	You can record to a six-track file.
2+4TR	You can record to a two-track file and a four-track file simultaneously.
1+5TR	You can record to a mono-track file and a five-track file simultaneously.

<Note>

See "Chapter 2: Before using the PD-6" on page 26 for details about the recording track modes.

<Note>

When a "Normal" mode audio file is played back, the level meters show the levels of tracks selected by the [REC TR] select switch.

6. [AUDIO FILE] select switch

Selects the file format (BWF or OPT) of a recording audio file. While the file is played back, the switch setting takes priority.

<Note>

This software version does not support the "OPT" position. Always use the unit with the [AUDIO FILE] select switch set to "BWF".

7. [TC OUT] switch

Selects the time code source (REPRO or GEN) fed from the [TIME CODE OUT] connector.

<Note>

See "Chapter 6: TC Setup mode" for details about output time code setting.

8. [PULL UP/DOWN] switch

Selects pull-up (+0.1 %) or pull-down (-0.1 %) of the sampling clock. The current TC frame rate also changes according to the switch position.

9. [OPEN] lever

Opens the tray protection cover.
To close the cover, press down the cover.

10. [EJECT] lever

Opens the disk tray.
When a disk is set on the tray, release the disk lock by pressing the [DISC UNLOCK] button before sliding the [EJECT] lever.
Normally, when no disk is set on the tray or the power is off, you can open the tray by only sliding the [EJECT] lever.

<Note>

On rare occasions, the disk lock may not be released. In such a case, turn off and on the power, then use the [DISC UNLOCK] button to release the disk lock.

11. [DISC UNLOCK] button

Releases the disk lock. This button is effective only when a disk is set on the tray.
To remove a disk, press this button then slide the [EJECT] lever to open the disk tray.

12. Disk tray

Sets a DVD-RAM disk.
To open the disk tray, use the [DISC UNLOCK] button and [EJECT] lever as described above. To close the disk tray, press down the tray.

Top panel (part 2)

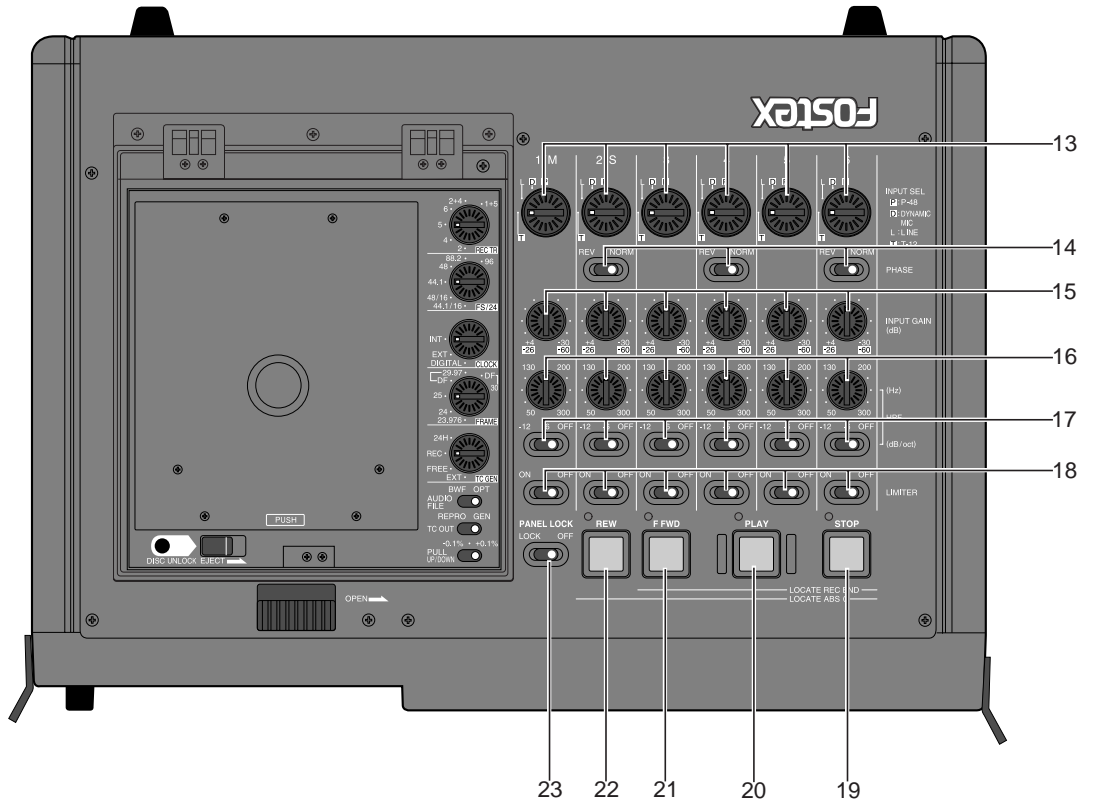

13. [INPUT MODE] switches

Each switch selects the type of analog audio input source for the corresponding channel from among the following.

L (Line)	Line-level input
D (Dynamic Mic)	Dynamic microphone
P (Phantom Power P-48)	48 V phantom powered microphone
T (Phantom Power T-12)	12 V phantom powered microphone

14. [PHASE] switches

Used to reverse the input phase. Only even (2, 4 and 6) channels offer the [PHASE] switches.

15. [INPUT GAIN] controls

Each control adjusts the input gain of the corresponding channel. The gain control range differs depending on the [INPUT MODE] setting, as follows.

When the [INPUT MODE] is set to "LINE":

You can adjust the nominal input level within the range between approximately -30 and +4dBu.

When the [INPUT MODE] is set to "D", "P" or "T":

You can adjust the nominal input level within the range between approximately -60 and -26dBu.

16. [HPF] controls

Each control controls the high-pass filter cutoff frequency of the corresponding channel within the range between 50 Hz and 300 Hz.

17. [HPF] switch

Each switch selects the high-pass filter response of the corresponding channel from among “OFF”, “-6 dB/oct.” and “-12 dB/oct.”.

18. [LIMITER] switch

Each switch selects the limiter for the corresponding channel active or inactive. The limiter parameters can be set using the “Limiter parameter” menu in the Setup mode (see “Chapter 7: Setup mode” on page 98).

19. [STOP] key/indicator (green)

Stops the recorder, as well as stops the disk rotation. This key is also used to exit a menu operation (of the Setup mode, Utility mode, etc).

<Note>

While operating the PD-6 with the battery, we recommend using the [STOP] key to stop playback rather than using the [PAUSE] key. Because using the [STOP] key stops the disk rotation, which saves battery power.

By pressing the [REW] or [F FWD] key while holding down the [STOP] key, the following operation is possible.

[STOP] + [REW]	Locates to the beginning (ABS 0) of the current file.
[STOP] + [F FWD]	Locates to the recording end (REC END) of the current file.

20. [PLAY] key/indicator (green)

Starts playback.

21. [F FWD] key/indicator (green)

Pressing this key while stopped fast-forwards the recorder at maximum 30 x speed.

Pressing this key during playback fast-forwards with sound (cues forwards) at 2 x speed.

Pressing this key while holding down the [STOP] key locates the recording end (REC END) of the current file.

22. [REW] key/indicator (green)

Pressing this key while stopped rewinds the recorder at maximum 30 x speed. Pressing this key during playback rewinds with sound (cues backwards) at 2 x speed.

Pressing this key while holding down the [STOP] key locates the beginning (ABS 0) of the current file.

23. [PANEL LOCK] switch

Switches the panel lock function active (LOCKED) or inactive (OFF).

When set it to the “LOCKED” position, the following keys/switch are inactive.

[STOP] key, [PLAY] key, [F FWD] key, [REW] key, [CIRCLE TAKE] key, [◀ SKIP/CURSOR ▶] key, [FILE SEL] key, [LOCATE] key, [POWER] switch

LCD display

The PD-6 is equipped with a 128 x 64 dot LCD display, which shows recording levels, recorder status, setting menus, etc.

Initial screen (Normal screen)

• When no disk is set

If you turn on the PD-6 when no disk is set, the display shows something like the following. After “—No Disk—” is briefly shown and the door lock is released, “-Unlock door-” is shown in the file name field.

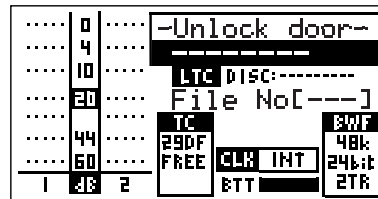

This screen is called “Normal screen” and includes the following information.

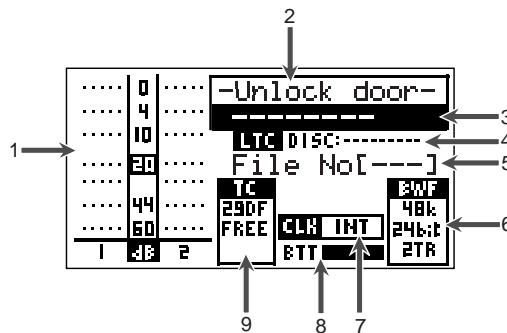

1	Level meter section	Shows the recording/playback level meters. The number of meters depends on the track mode selected by the [REC TR] switch. The screen above shows the example when the 2-track mode is selected.
2	File name field	Shows the audio file name (up to 13 characters) or the frame rate of external time code while LTC IN is shown in the time display field.
3	Time display field	Show the time value of the current file position in “ABS” or “LTC”. It also can show an external time code value or internal generator time code value. You can select the time display mode using the [TIME/DISP MODE] key.
4	Remain field	Shows the remaining recordable time of the disk.
5	File No. field	Shows audio file No.
6	File information field	Shows Fs, bit and recording track mode of the file. It follows the [REC TR] and [FS/24] switch settings.
7	Clock field	Shows the current reference clock (INT, EXT or DIGITAL).
8	Battery field	Shows the internal battery voltage. When the AC adapter (AD-15C) is used, it fully lights.
9	TC field	Shows the frame rate of recording time code and TC GEN mode. It follows the [FRAME] and [TC GEN] switches.

•When you set an unused disk

If you set an unused disk after turning on the PD-6, the display prompts you to format the disk, as below. See page 24 for details about disk formatting.

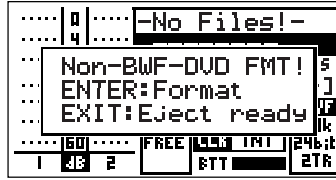

•When you set a disk with recorded data

If you set a disk with recorded data after turning on the PD-6, the file name and No. are shown in the appropriate fields.

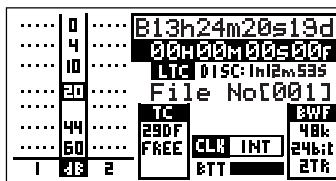

Other screens

•Time display mode selection

Each press of the [TIME/DISP MODE] key (when unSHIFTed) switches the time display mode in the following order.

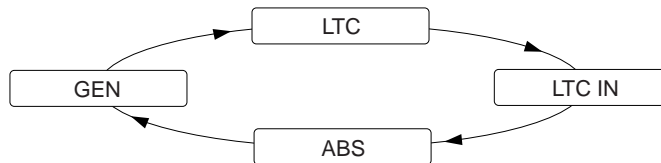

LTC	Shows LTC recorded on the disk. You can set the start time of LTC recording using the appropriate menu in the TC Setup mode.
LTC IN	Shows incoming external LTC. If no LTC is received, “———” is shown.
ABS	Shows the absolute time, which is set to “00H00M00S00SF” at the beginning of the file.
GEN	Shows time code generated by the internal TC generator. The value depends on [TC GEN] switch setting.

• Display mode selection

While SHIFTed, each press of the [TIME/DISP MODE] key switches the display between the “Normal screen” and “Level screen”.

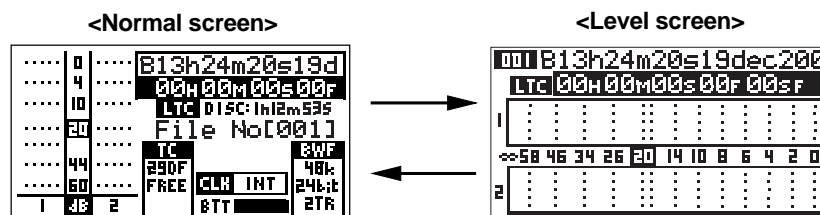

• Level meter section

Depending on the [REC TR] select switch setting, the level meter section on the screen looks like the following.

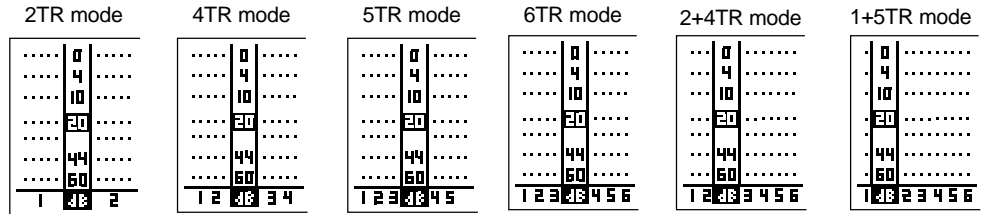

<Note>
 With a "Tape" mode file, the level meter section looks the same regardless of the [REC TR] select switch setting.

• Setup mode screen

Pressing the [SETUP/UTILITY] key (while unSHIFTed) brings up the primary page of the Setup mode screen. Using Setup mode menus, you can set preferences, etc. of the PD-6. See "Chapter 7: Setup mode" on page 87 for details about the Setup mode.

```

SETUP▶
▼Adjust RTC▶
Digital out: AES/EBU
Digital in▶
Skip mode: File
Diagnoses: On
Ref.level: -20dB
    
```

• Utility mode screen

Pressing the [SETUP/UTILITY] key while SHIFTed brings up the primary page of the Utility mode screen. Using Utility mode menus, you can make settings related with DVD-RAM disks to be used with the PD-6, as well as format a disk. See "Chapter 8: Utility mode" on page 105 for details about the Utility mode.

```

UTILITY▶
▼Edit file name▶
File info.▶
Delete file▶
Restore Del. file▶
Optimize disk▶
Format▶
    
```

• TC Setup mode screen

Pressing the [CONTRAST/TC SETUP] key while SHIFTed brings up the primary page of the TC Setup mode screen. Using the TC Setup mode menus you can make preferences/settings related with time code recording/playback. See "Chapter 6: TC Setup mode" on page 81 for details about the TC Setup mode.

```

TC SETUP▶
▼Edit LTC start▶
Pause TC: Off
TC Ubit: EEEEEERRR
Set Gen.TC▶
Gen Ubit: <User>
JAM mode: BOTH
    
```



Chapter 4: Basic connections

This chapter describes the basic connection between the PD-6 and external devices.

<Table of contents>

Input connection	48
Analog audio input connection	48
Digital audio input connection	49
Time code input connection	49
Sync signal connection	49
Monitor signal input connection	49
Output connection	50
Analog audio output connection	51
Digital audio output connection	51
Time code output connection	51
Word clock output connection	51
Monitor output connection	51
Connection examples	52
Connection example for recording (1)	52
Connection example for recording (2)	53
Other connection examples	54
Example of PC connection	54
Example of USB keyboard connection	54
Power supply for external devices	55

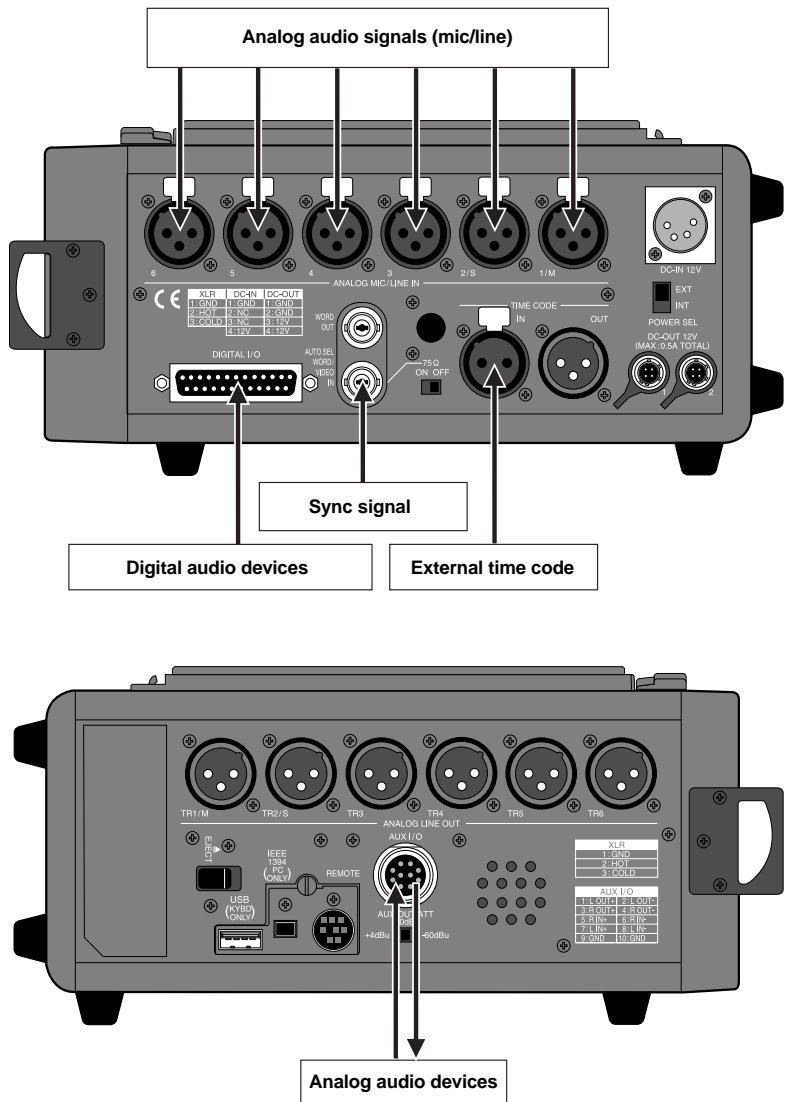
Input connection



Analog audio input connection

The PD-6 provides six analog mic/line input channels (channels 1 through 6) with six-channel mixing capability, which allows location mixing and recording without the need of an external mixing console. Six balanced XLR-3-31 type connectors, which accept a wide range of audio signal level from mic to line, are used.

To record an analog audio signal, connect an analog source to any of the six [ANALOG IN] connectors (XLR-3-31 type), and set the corresponding [INPUT MODE] switch to the appropriate position (LINE, D, P or T) according to the input source. See “Chapter 5: Recording/playback” on page 57 for details about the [INPUT MODE] switch setting.

The PD-6’s six-channel mixer provides the phantom power supply which allows the PD-6 to accept condenser microphones, as well as dynamic microphones. It also provides HPFs (High Pass Filters) and limiters.

Digital audio input connection

The PD-6 accepts digital signals conformed to IEC 60958 (AES/EBU) or IEC 60958 (S/P DIF) format (the format of the digital source is automatically detected). The digital connection is made via the D-sub 25-pin DIGITAL I/O connector.

To record a digital audio source, connect a digital source to the [DIGITAL I/O] connector, and set the digital input channels appropriately using the “Digital in” menu in the Setup mode. The digital input channels can be set in 2-channel pairs (1-2, 3-4 and 5-6).

When the PD-6 receives a digital source from the selected channel, PLL (Phased-locked loop) activates and locks to the input sync signal.

<Note>

When the sampling frequency of the input signal does not match the [FS/24] switch setting, the switch setting indication shown on the screen flashes for warning.

Time code input connection

The [TIME CODE IN] connector (balanced, XLR-3-3-1) accepts SMPTE/EBU time code. To record external time code, set the [TC GEN] mode switch to “EXT RUN”.

When the PD-6 receives valid external time code from the [TIME CODE IN] connector, the “EXT TC” indicator is lit on the screen. When time code satisfies the following conditions, it is “valid”.

- 1) Runs in normal direction and value is continuous.
- 2) Sync word matches the frame rate.
- 3) Time code is not dropped out.

• For details about how to jam to external time code, see “Chapter 5: Recording/playback” described later.

Sync signal connection

The PD-6 provides the [WORD/VIDEO IN] connector (BNC type) which is used to lock the PD-6 to an external word or video reference. The connector accepts a word or video clock from an external device, which easily makes the PD-6 locked to the external device. The PD-6 also provides the [WORD OUT] connector which feeds a word clock to an external device.

Monitor signal input connection

The PD-6 provides the [AUX IN] connector which receives an external monitor signal. A Hirose 10-pin connector is used for the [AUX IN] connector.

The signal received by the [AUX IN] connector is sent to the PD-6 monitor section, and can be monitored via headphones (or internal monitor speaker) in the similar manner to stereo buss signals.

Output connection

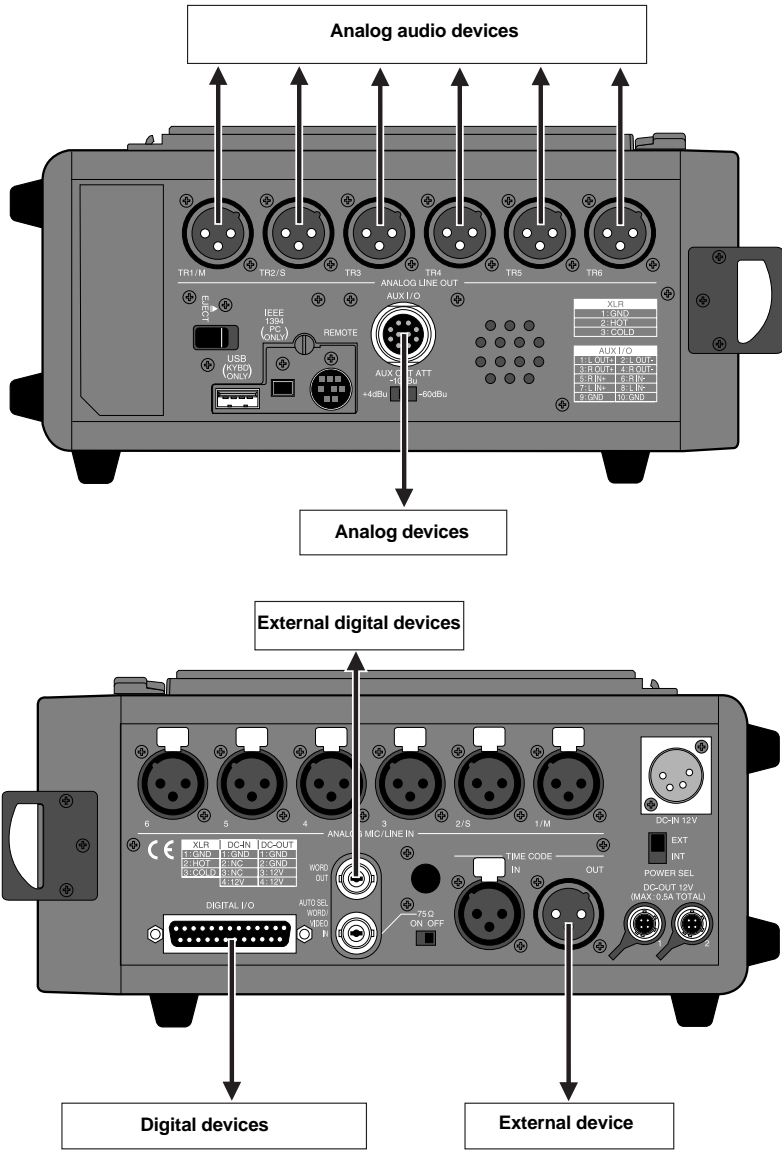

Analog audio output connection

Analog audio signals can be output from the [ANALOG LINE OUT] connectors (1 through 6), which are balanced, XLR-3-32 type. The output reference level is +4 dBu which corresponds to -12 dB of the LCD level meters.

<Note>
 To connect the [ANALOG LINE OUT] connector to an unbalanced input, only use the GND and hot pins. With this connection, the output level is 6 dB lower than the balanced connection but there is no audio quality deterioration. Connecting the cold pin to the GND pin increases the crosstalk and noise, as well as consumes more battery power.

Digital audio output connection

The digital audio signals can be output from the [DIGITAL OUT] connector (D-sub 25-pin type) in the IEC 60958 (AES/EBU) or IEC 60958 (S/P DIF) format.

You can select the digital output signal format (AES/EBU or S/P DIF) using the “Digital out” menu in the Setup mode (. See page 91 for details about the “Digital out” menu.

Time code output connection

You can output SMPTE/EBU time code from the [TIME CODE OUT] connector (balanced, XLR-3-32 type).

According to the [TC OUT] switch setting, time code recorded on a disk (REPRO TC) or generated by the internal time code generator (INT GEN TC) can be output.

Word clock output connection

Using the [WORD OUT] connector (BNC type), you can feed a word clock to a digital device which needs to get a word clock for synchronization.

Monitor output connection

The stereo buss L/R signals can be output from the [AUX OUT] connectors. So, you can monitor the stereo buss signals from an external monitor system, as well as from the internal monitor speaker and headphones.

Connection examples

Connection example for recording (1)

The following shows the example of using the PD-6 with microphones, which makes the best use of the PD-6 and can be applied to news gathering, audio recording for film, etc.

In the example below, audio signals from microphones and time code generated by the external time code generator are simultaneously recorded to the PD-6, while the same time code is also recorded to the VTR along with a video camera signal.

Up to six microphones can be connected to the PD-6 input channels. Each of the input channels provides the phantom power supply, gain control, limiter and high-pass filter, allowing the PD-6 to accept any kinds of microphones.

The external time code generator output is connected to both the VTR's time code input and the PD-6 [TIME CODE IN] connector. Using the PD-6 jam function, the PD-6 time code generator can run with extreme accuracy after it locks to the external time code. Therefore, you can make PD-6 recording in sync with the VTR even if you disconnect the time code input after the PD-6 generator locks to the external time code. When the external time code is disconnected, the internal generator runs with its own crystal (when the TC GEN mode is set to "FREE RUN").

See "Chapter 5: Recording/playback" on page 72 for details about the jam function.

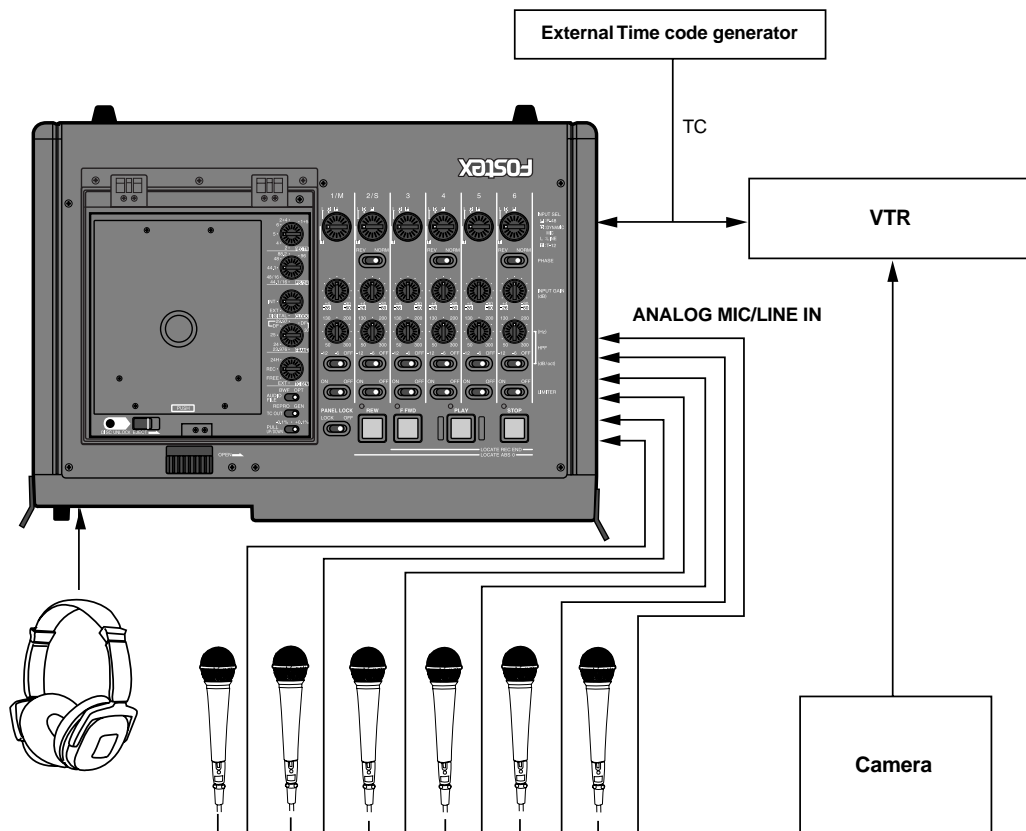

Connection example for recording (2)

In the next example, four main microphones (mono) and two ambience microphones (stereo) are connected to the PD-6 six-channel mixer, allowing recording without using an external mixer.

Unlike the previous example, the time code generated by the PD-6 internal time code generator is the master which is fed to the VTR. The [ANALOG LINE OUT] connector can always feeds the mixed source signals, which can be recorded to the VTR audio tracks for the backup purpose.

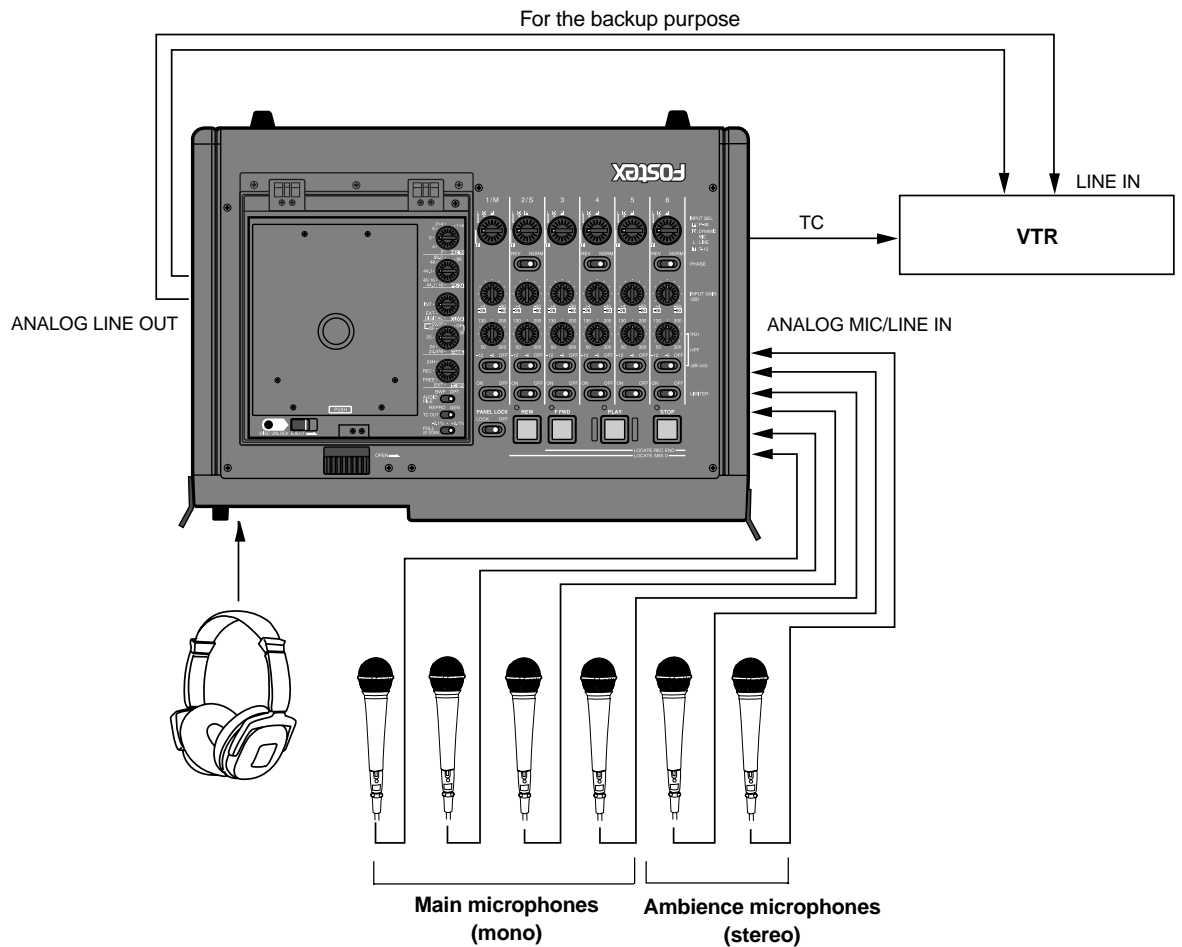

Other connection examples

Example of PC connection

The PD-6 provides the IEEE1394 connector. By connecting a personal computer to this connector, you can control the PD-6 drive from the personal computer. See page 135 for details about audio file export/import.

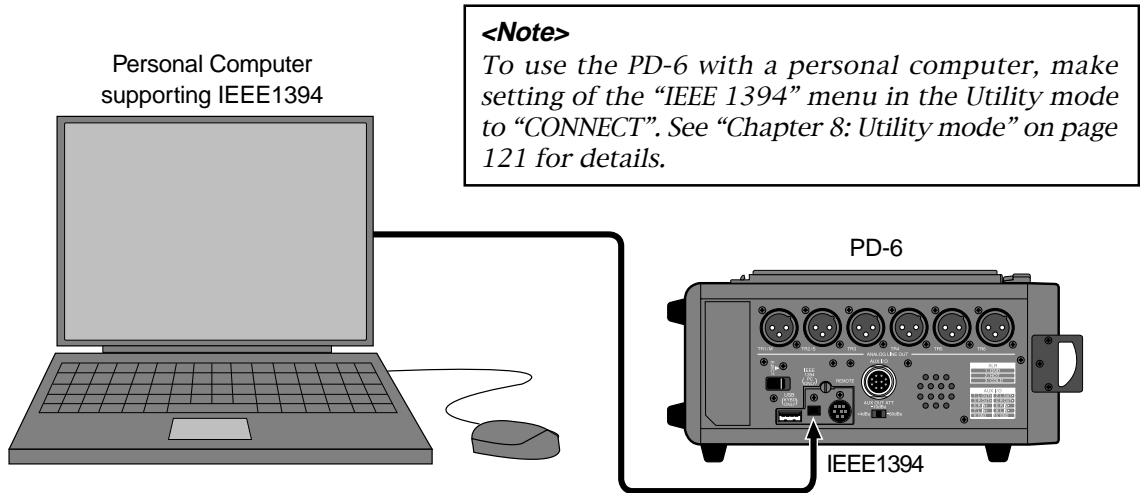

Example of USB keyboard connection

The PD-6 provides the [USB] connector only for connecting a USB keyboard. By connecting a USB keyboard to this connector, you can enter file and label names, as well as carry out some of menu operations, from the keyboard.

- <Notes>**

 - To control the PD-6 from the USB keyboard, make setting of the [Keyboard" menu in the Setup mode appropriately ("US" or "JAPAN") according to the keyboard connected. See "Chapter 7: Setup mode" for details.
 - With some keyboard, indicators may not light until pressing a key after connection.
 - We cannot guarantee to work correctly if you use a keyboard with built-in USB hub, USB mouse or PS2 mouse.

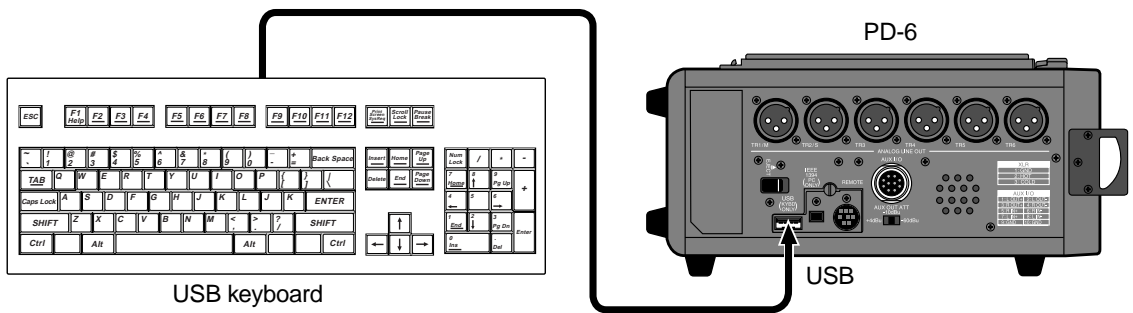

Function key

F1 key	Brings up the “Edit file name” menu in the Utility mode.
F2 key	Acts the same as the [CIRCLE TAKE] key on the panel.
F3 key	Brings up the “Default file name” menu in the Setup mode.
F4 key	Brings up the “Default track name” menu in the Setup mode.

Shortcuts

ALT + F keys	Acts the same as the [FILE SEL] key on the panel.
ALT + C keys	Acts the same as the [CUE] key on the panel.
ALT + S keys	Enters the Setup mode.
ALT + U keys	Enters the Utility mode.
ALT + T keys	Enters the TC Setup mode.
ALT + E keys	Enters the EDL SEL mode.
CTRL + L keys	Acts the same as the [LOCATE] key on the panel.

Enters the TC Setup mode.

UP/DOWN LEFT/RIGHT key	These keys can be used to enter characters or move the cursor position when editing the name for a label or file name or in the Setup mode.
ESC key	Acts the same as the [EXIT] key on the panel.
ENTER key	Acts the same as the [ENTER] key on the panel.

Power supply for external devices

The PD-6 provides a pair of the [DC OUT] connectors, from which “DC 12 V” power can be supplied to external devices.

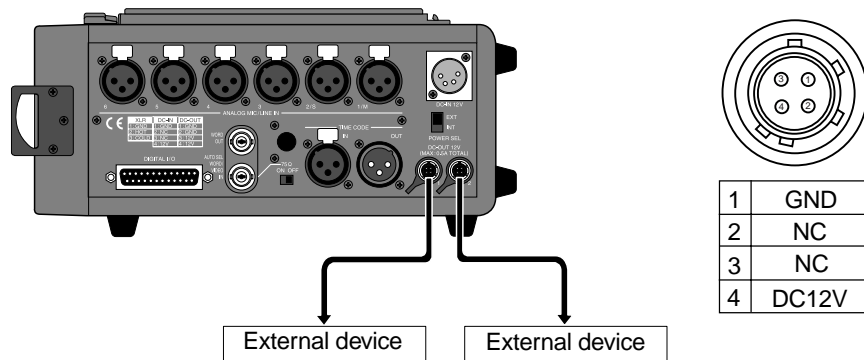

<Notes>

- The [DC OUT] connectors can deliver, in total, up to 0.5 ampere electric current at DC 12V. Make sure that the total ampere rating of the devices connected to the [DC OUT] connectors does not exceed 0.5 ampere.
- We strongly recommend to use the [DC OUT] connectors while the PD-6 is running with the AC adaptor (or an external battery). If you use the [DC OUT] connectors to supply the power to one or two external devices while the PD-6 is running with the internal battery, the battery power is exhausted quickly.

Chapter 5: Recording/playback

This chapter describes basic audio and time code recording/playback, as well as cue point creation and skip/locate function.

<Table of contents>

Recording analog audio	58
Selecting an input source	59
Adjusting the input gain	59
Filter setting	60
Limiter setting	60
Selecting the sampling frequency	61
Selecting recording tracks	62
Selecting a recording source	63
Adjusting the recording level	63
Monitoring recording signals	64
Making recording	65
Recording with the PRE REC mode active	66
Recording a slate tone/slate mic signal	67
About overloading	67
File names of created audio files	68
Recording digital audio	69
Selecting digital input channels	69
Selecting the sampling frequency	69
Selecting the system master clock	69
Recording time code	70
Selecting the TC frame rate	70
Selecting the TC generate mode	71
Setting the time code output	71
Jam function	72
Creating cue points	73
Creating a cue point automatically at the recording start point	73
Creating a cue point on-the-fly	73
Viewing the cue point list	74
Editing a cue point	74
Creating a new cue point using the cue list screen	75
Playback	76
Normal audio playback	76
Time code playback	77
Cueing playback	77
Skip/locate functions	78
Skipping by file	78
Skipping by cue point	78
Locating to the beginning (ABS 0) of a file	78
Locating to the end (REC END) of a file	78
Locating to the previous locate point	78
Locating to the desired time	79
Locating to the desired cue point	79

Recording analog audio

To record analog audio, some control and switch settings are necessary. The following shows the block diagram of the built-in 6-channel mixer of the PD-6.

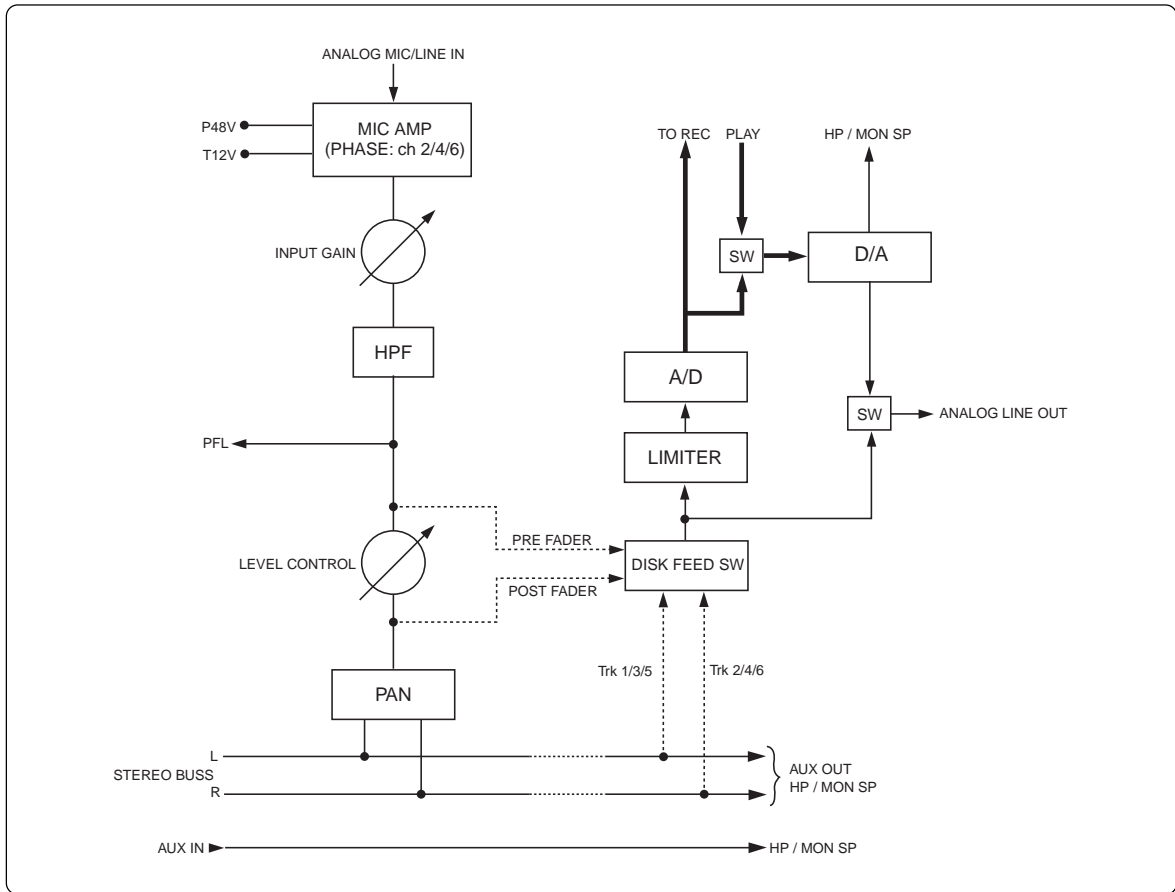

The following table shows availability of PD-6 record modes both for “Normal” and “Tape” mode disks.

*The availability for a “Tape” mode disk is shown in parentheses.

Set the [FS/24] and [REC TR] switches appropriately according to the table.

44.1kHz/16bit, 44.1kHz/24bit 2 track	Yes (Yes)	48kHz/16bit, 48kHz/24bit 1+5 track	Yes (No)
48kHz/16bit, 48kHz/24bit 2 track	Yes (Yes)	88.2kHz/24bit 4 track	No (No)
88.2kHz/24bit 2 track	Yes (Yes)	96kHz/24bit 4 track	No (No)
96kHz/24bit 2 track	Yes (Yes)	88.2kHz/24bit 5 track	No (No)
44.1kHz/16bit, 44.1kHz/24bit 4 track	Yes (Yes)	96kHz/24bit 5 track	No (No)
48kHz/16bit, 48kHz/24bit 4 track	Yes (Yes)	88.2kHz/24bit 6 track	No (No)
44.1kHz/16bit, 44.1kHz/24bit 5 track	Yes (Yes)	96kHz/24bit 6 track	No (No)
48kHz/16bit, 48kHz/24bit 5 track	Yes (Yes)	88.2kHz/24bit 2+4 track	No (No)
44.1kHz/16bit, 44.1kHz/24bit 6 track	Yes (Yes)	96kHz/24bit 2+4 track	No (No)
48kHz/16bit, 48kHz/24bit 6 track	Yes (Yes)	88.2kHz/24bit 1+5 track	No (No)
44.1kHz/16bit, 44.1kHz/24bit 2+4 track	Yes (No)	96kHz/24bit 1+5 track	No (No)
48kHz/16bit, 48kHz/24bit 2+4 track	Yes (No)		
44.1kHz/16bit, 44.1kHz/24bit 1+5 track	Yes (No)		

You can make recording on both sides A and B of an 8-centimeter DVD-RAM disk. The following table shows the approximate recording time (in minute) for each side according the [FS/24] and [REC TR] switch settings.

44.1kHz/16bit-2TR	118	44.1kHz/24bit-2TR	78	88.2kHz/24bit-2TR	39
48kHz/16bit-2TR	108	48kHz/24bit-2TR	72	96kHz/24bit-2TR	36
44.1kHz/16bit-4TR	59	44.1kHz/24bit-4TR	39		
48kHz/16bit-4TR	54	48kHz/24bit-4TR	36		
44.1kHz/16bit-5TR	47	44.1kHz/24bit-5TR	31		
48kHz/16bit-5TR	43	48kHz/24bit-5TR	28		
44.1kHz/16bit-6TR	39	44.1kHz/24bit-6TR	26		
48kHz/16bit-6TR	36	48kHz/24bit-6TR	24		

Selecting an input source

Set the [INPUT MODE] switch appropriately according to the source (microphone or line) connected to the [ANALOG MIC/LINE IN] connector.

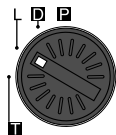
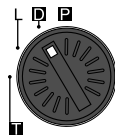
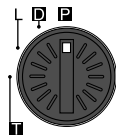
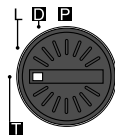
Line input		Mic input	
"L" position	"D" position	"P" position	"T" position
			
For a line level analog audio signal	For a dynamic microphone	For a condenser microphone which requires the DC 48 V phantom power.	For a condenser microphone which requires the DC 12 V phantom power.

On channels 2, 4 and 6, the [PHASE] switches are provided, allowing reversing the phase.

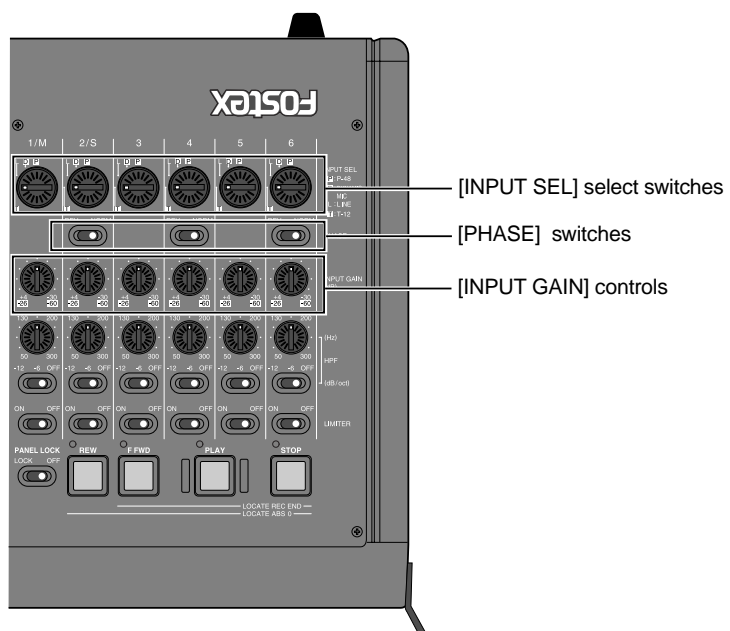

Adjusting the input gain

Using the [INPUT GAIN] control, you can adjust the input gain for each mixer channel within the following range.

When the [INPUT MODE] switch is set to "D", "P" or "T":	You can adjust the normal input level within the range between approximately -60 and -26 dBu.
When the [INPUT MODE] switch is set to "L":	You can adjust the normal input level within the range between approximately -30dB and +4 dBu.

Filter setting

The PD-6 is equipped with the high-pass filter circuit. The cutoff frequency can be adjusted within the range between 50 Hz and 300 Hz, and the filter slope can be selected between -6 dB/oct. and -12 dB/oct.

The filter is useful to eliminate the wind noise during location recording or unnecessary low frequency noise when recording voice or sound.

You can make filter setting for each channel individually.

Limiter setting

By using the limiter when recording microphone sound, the signal level is prevented from exceeding a certain level. In result, the signal level fluctuation is suppressed. You can activate the limiter channel by channel, by setting the [LIMITER] switch to "ON".

The PD-6 limiter uses the VCA (Voltage Controlled Amplifier) circuit. By default, the threshold is -12 dB under the 24-bit full-scale level (all bits are on) and the compressed ratio is 1:3. The limiter attack time is fixed to 20 ms, while the release time is fixed to 150 ms.

You can set the threshold and level for each channel individually using the "Limiter parameter" menu in the Setup mode (see "Chapter 7: Setup mode" on page 98 for details).

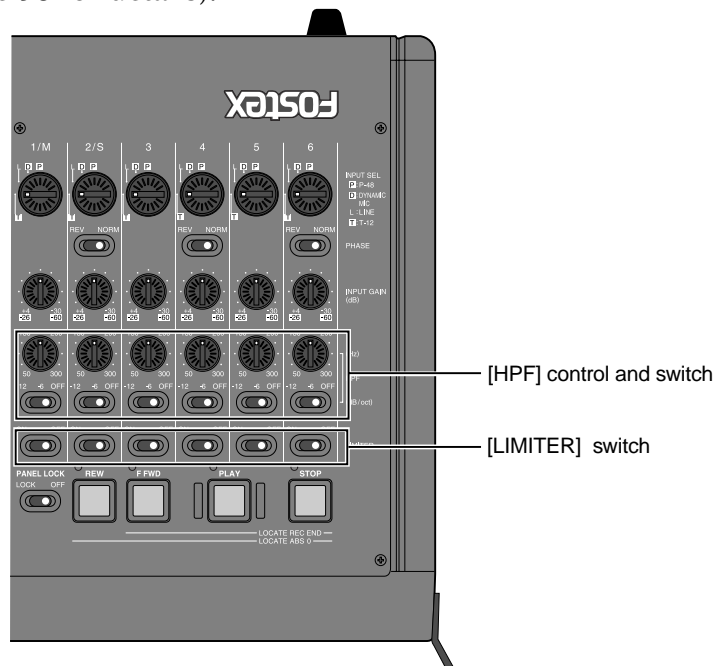

Selecting the sampling frequency

You can select the sampling frequency (Fs) only when recording an analog signal by using the [FS/24] switch on the top panel.

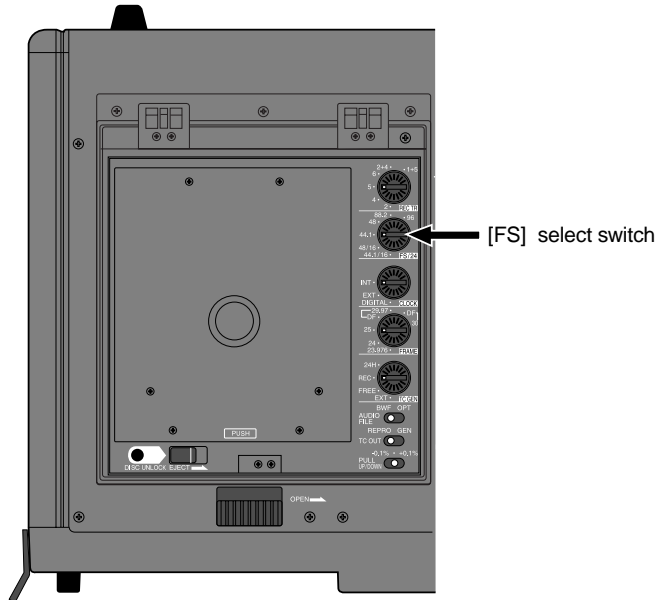

You can select the Fs (and quantization bit) from among 44.1/16 bit, 48/16 bit, 44.1/24 bit, 48/24 bit, 88.2/24 bit and 96/24 bit. The current setting is shown on the screen.

While receiving a digital signal, the PD-6 automatically detects the Fs from the receiving digital signal, which takes priority to [FS/24] switch setting.

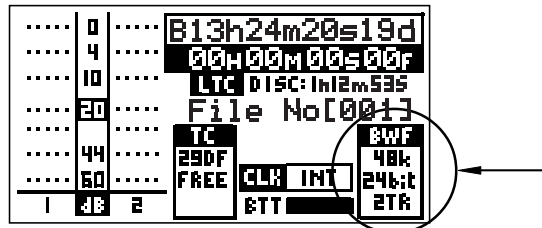

<Note>

During recording, you cannot change the Fs. If you change the [FS/24] switch setting during recording, the switch setting becomes effective when recording stops.

Available formats for recording (related to the [FS/24] switch and [REC TR] switch settings)

		REC TR					
		2	4	5	6	2+4	1+5
FS SW	44.1/16	Yes	Yes	Yes	Yes	Yes	Yes
	48/16	Yes	Yes	Yes	Yes	Yes	Yes
	44.1/24	Yes	Yes	Yes	Yes	Yes	Yes
	48/24	Yes	Yes	Yes	Yes	Yes	Yes
	88.2/24	Yes	No	No	No	No	No
	96/24	Yes	No	No	No	No	No

Selecting recording tracks

According to the situation, select the recording track mode from among the following using the [REC TR] select switch. Depending on the selected mode, the level meter section on the display is shown differently (except a “Tape” mode disk).

2TR	You can record to a stereo-track file.
4TR	You can record to a four-track file.
5TR	You can record to a five-track file.
6TR	You can record to a six-track file.
2+4TR	You can record to a two-track file and a four-track file simultaneously. For example, you can record sources directly to the four-track file and a rough stereo mix to the two-track file.
1+5TR	You can record to a mono-track file and a five-track file simultaneously. For example, you can record sources directly to the five-track file and a rough mono mix to the a mono-track file.

<Notes>

- When playing back each individual file recorded in the “2+4TR” or “1+5TR” mode, the audio fed from the [ANALOG LINE OUT] connectors differs depending on the [REC TR] switch position. See “Playback” on page 78 for details.
- When making recording to a “Tape” mode disk, the [REC TR] switch setting is not needed. The recording track mode is determined by the [REC TR] switch setting when the disk has been formatted. See “Format menu” on page 115 for details.

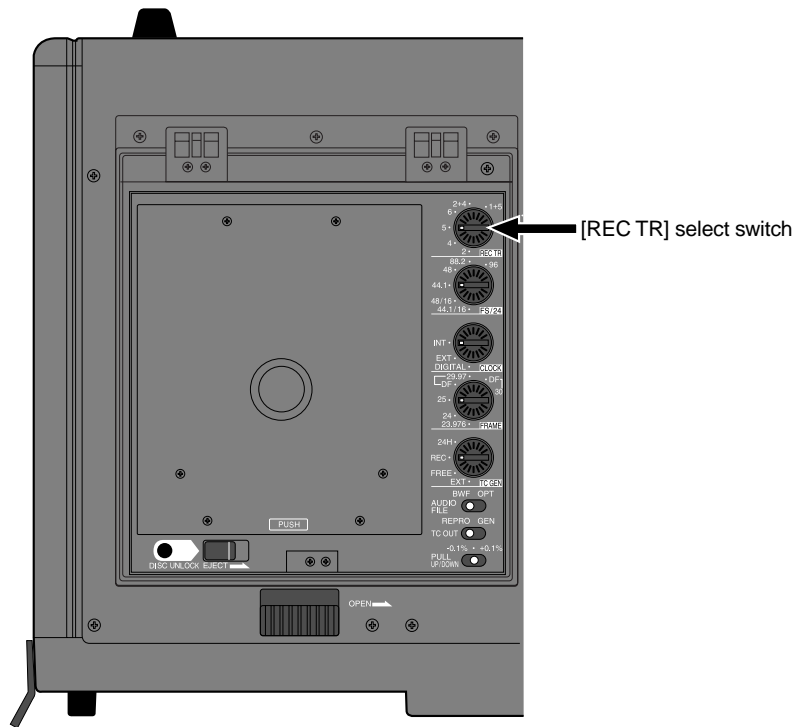

Selecting a recording source

Using the [DISC FEED] switches, select a recording source for each track.

PRE	Channel pre-fader signal is selected.
L, R BUS	Stereo buss (L or R) signal is selected. The “L” signal can be assigned to the odd tracks, while the “R” signal can be assigned to the even tracks.
POST	Channel post-fader signal is selected.

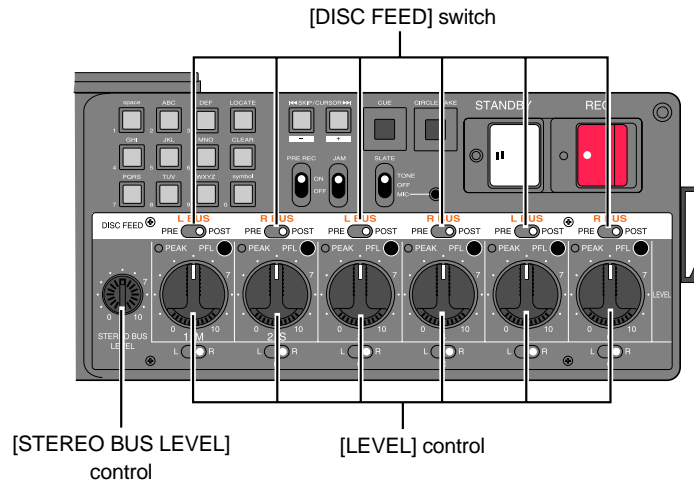

Adjusting the recording level

According to the recording source selected by the [DISC FEED] switch, use the appropriate control to adjust the record level for each channel.

When set to “PRE”:	Use the [INPUT GAIN] control.
When set to “L BUS” (or “R BUS”):	Use the [LEVEL] control to adjust the level sent from each channel to the stereo buss, and use the [STEREO BUS LEVEL] control the total recording level. Also select the pan position from among L, C and R.
When set to “POST”:	Use the [LEVEL] control.

<Notes>

- Adjust the recording level appropriately so that the level meter does not exceed “0 dB”. To get the maximum signal-to-noise performance, set the level appropriately so that the meter indication does not exceed “0 dB” but goes up near to the “0 dB” at the loudest part of the signal. The reference level is set to “-20 dB” by default, which means, +4 dBu signal shows -20 dB from the 24-bit full-scale level (0 dB) on the level meter. You can change the reference level to “-18 dB” using the “Ref. level” menu in the Setup mode. See “Chapter 7: Setup mode” on page 93 for details.
- You can set to generate the error tone if the input amplifier clips using the “Error tone” menu in the Setup mode (see page 96).

Monitoring recording signals

You can monitor recording signals via headphones (or the internal monitor speaker). While a plug is inserted to the [PHONES] jack, the internal speaker automatically turns off, and you can monitor the signals only via headphones.

The monitor level can be adjusted by the [MONITOR] control. This control is a push-lock type. By pushing the head of the control, the control comes out and you can rotate the control to adjust the level. Pressing the control again puts it inside the panel. To turn off the monitor sound completely, rotate the control fully counterclockwise until it clicks.

<Note>
 While running the PD-6 with the internal battery, we recommend not to raise the monitor volume more than required. Raising the volume consumes more battery power.

The monitor signal can be selected by the following switch settings.

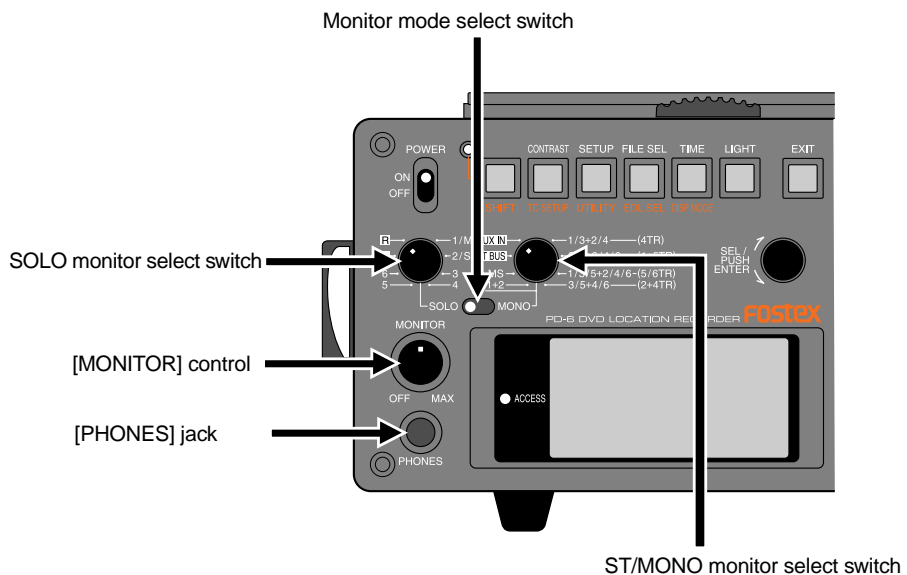

• Monitor mode select switch

Selects the monitor mode from among SOLO, ST and MONO.

SOLO	Monitors a single track/input channel in mono.
ST	Monitors a stereo mix of tracks/input channels.
MONO	Monitors a mono-mix of tracks/input channels.

• ST/MONO monitor select switch

When the monitor mode select switch is set to “MONO” or “ST”, this switch selects the tracks/input channels to be monitored.

• SOLO monitor select switch

When the monitor mode select switch is set to “SOLO”, this switch selects the track/input channel to be monitored. Note that, when the monitor mode select switch is not set to “SOLO”, this switch is not effective.

Making recording

After making the necessary switch/level settings for recording, you can start recording.

<Note>

By default, you can make recording of analog input signals of all mixer channels if each channel receives only an analog signal. If a channel receives both an analog and digital signals, the digital signal takes priority and the analog signal of this channel is not recorded.

If you want to make recording of analog signals for some channels and digital signals for the other channels simultaneously, use the “Digital in” menu in the Setup mode to select the analog or digital inputs for each two-channel pairs. See “Digital input channel setting” on page 91 for details about the “Digital in” menu.

1. To start recording, slide the [REC] key.

With a Normal mode disk, the PD-6 creates a “New File” and starts recording to it.

By default, the real-time clock time data is given as the file name when an audio file is created. (Example: “B19h 00m 30s 06jan 2003.wav”)

<Note>

Using the “Default file name” menu in the Setup mode, you can set the default file name given when an audio file is created to “desired scene name + take number” instead of the real-time clock time data. See “Chapter 7: Setup mode” on page 99 for details.

2. To stop recording, press the [STANDBY] key.

During recording, only the [STANDBY] key is effective. To stop the recorder completely, press the [STOP] key after pressing the [STANDBY] key.

Note that the recorder automatically stops completely after a certain period of time since it enters the pause mode. This period is set to three minutes by default, but can be changed to a desired period between 0.1 and 9.9 minutes in 0.1 minute steps or infinity using the “Pause time” menu in the Setup mode. See “Chapter 7: Setup mode” on page xx for details.

If you press the [LOCATE] (or [STOP] + [REW]) key after stopping recording, the recorder locates to the beginning of the newly created audio file. Therefore, you can check the recording by pressing the [PLAY] key in this condition.

<Note>

With a Normal mode disk, every time you start recording after stopping recording, a new audio file is created and recording is made from the beginning of the new file. With a Tape mode disk, every time you start recording after stopping recording, recording is made from the current position.

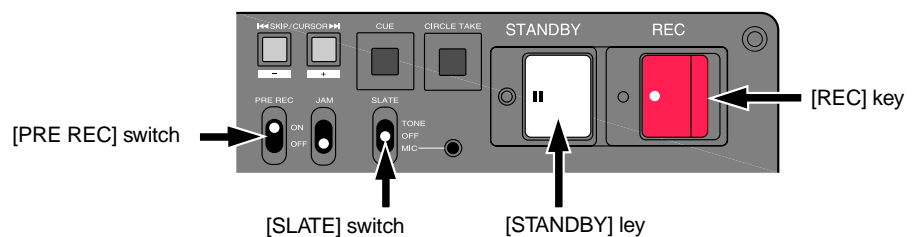

<Note>

If you have made recording unsuccessfully, you can cancel the recording and clear the audio file immediately.

After recording is made, pressing the [STANDBY] key while holding down the [CLEAR] key brings up the screen as shown below.



Then pressing the [ENTER] key cancels the recording you made last time and clears the audio file. After the PD-6 clears the file, the display shows "Completed!" briefly, followed by the screen of the audio file which was loaded before the audio file you have just cleared was made.

To cancel clearing the file while the screen above is shown, press the [EXIT] key.

The operation described above is effective only for the last recording, and you cannot restore the file once it is cleared.

• Recording with the PRE REC mode active

If you start recording with the [PRE REC] switch set to "ON", the buffered audio data is also recorded. This function may prevent you from missing the beginning of important recording.

The buffered time is set to 10 seconds by default, but this can be changed to desired time between 1 and 10 seconds in 1 second steps using the "Pre rec time" menu in the Setup mode. See "Chapter 7: Setup mode" on page 101 for details.

If you press the [STANDBY] key to stop recording, the recorder will stop after executing "post recording" which records audio data currently stored in the buffer.

<Notes>

- Do not alter the [PRE REC] switch setting during recording.
- When the [PRE REC] switch is set to "ON", the [ANALOG LINE OUT] connectors output analog audio input signals with no delay, but output a delayed digital input signal.
- If you switch the Fs setting to "ON", wait for 10 seconds before starting recording. Otherwise, the audio signal stored in the buffer is recorded with the pitch altered.
- When making recording at 88.2kHz or 96kHz Fs with the "Pre rec" switch set to "ON", the maximum buffered time is limited to five seconds. Therefore, even if you set the "Pre rec time" menu to more than 5 seconds, the recording buffer can hold only 5-second audio data.

• **Recording a slate tone/slate mic signal**

While sliding and holding the [SLATE] switch to “TONE” or “MIC”, the slate tone (at 1 kHz, reference level) or the slate microphone signal is fed to all tracks and stereo busses, allowing you to record the slate tone or the slate microphone signal during recording.

You can adjust the recording level of the slate tone in the following manners depending on the [DISC FEED] switch setting.

The setting of the [DISC FEED] switch		
PRE position	L, R BUS position	POST position
Regardless of the [LEVEL] and [STEREO BUS LEVEL] control settings, the slate tone is recorded at the reference level.	The [STEREO BUS LEVEL] control can be used to adjust the slate tone recording level.	The [LEVEL] control can be used to adjust the slate tone recording level.

If you set the “Tone rec mode” menu in the Setup mode appropriately, the slate tone is automatically recorded at the beginning of an audio file when recording is made to a “Normal” mode disk. (Note that this function is not available when recording to a “Tape” mode disk.)

You can set the duration of the slate tone automatically recorded between 1 and 10 seconds (default: 10 seconds), as well as select between two types; continuous tone or 4 pop tones. For details, see “Tone rec mode” on page 94.

<Notes>

- The slate tone is used for analog level calibration, therefore, it is not recorded when selecting the digital input.
- While sliding and holding the [SLATE] switch to the “TONE” position, the slate tone is output from the [ANALOG LINE OUT] connectors, allowing to calibrate external devices.

• **About overloading**

While receiving an analog audio signal, if the input amplifier is clipped, the corresponding PEAK indicator is lit in red. The responsibility of the detecting circuit is approximately 10 milliseconds, and the indicator lights for more than 1.5 seconds against momentary clipping.

By setting the “Input clip” item to “On” using the “Error tone” menu in the Setup mode, the error tone is generated from the internal speaker or headphones for warning. See “Chapter 7: Setup mode” on page 96 for details.

<Note>
If the [MONITOR] control is set to “OFF”, you cannot hear the error tone.

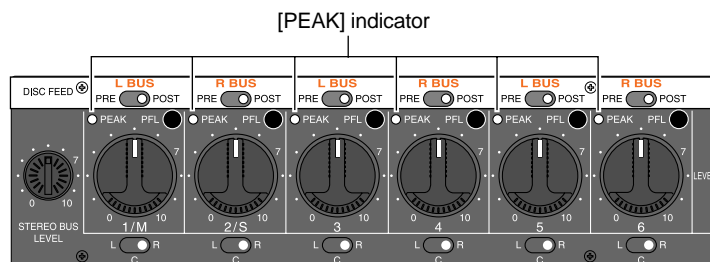

• **File names of created audio files**

When making recording in any of the single-file modes (2TR, 4TR, 5TR or 6TR), the real-time clock time data when starting recording is given as the file name by default.

Example: “B15h 11m 25s 07jan 2003.wav”

The leftmost “B” stands for “BWF”. The file extension (“.wav”) is automatically appended.

By setting the “File name mode” item to “Take” instead of “Date” using the “Default file name” menu in the Setup mode, “Scene name + Take number” is given as the default file name. In this setting, you can also set a desired scene name and take number. See “Chapter 7: Setup mode” on page 99 for details.

Example: “Action-001.wav” (when “SCENE NAME” and “TAKE NUMBER” are set to “Action” and “-001” respectively.) The file extension (“.wav”) is automatically appended.

If you repeat creating new files in the above setting, the similar file name as above, except that the take number is automatically incremented, is given to each file. If you make recording in either of two-file mode (2+4TR or 1+5TR), the names of two created files given are as below.

When “Default file name” is set to “Date”:

File 001: “M15h 11m 25s 07jan 2003.wav” (begins by “M”)

File 002: “B15h 11m 25s 07jan 2003.wav”

When “Default file name” is set to “Take” (when “SCENE NAME” and “TAKE NUMBER” are set to “Action” and “-001” respectively.):

File 001: “ActionM-001.wav” (“M” is appended after the scene name)

File 002: “Action-001.wav”

In both cases, “M” stands for “multitrack”. File 001 (with “M”) corresponds to the 4-track or 5-track file. Also note that, for the two files created in two-file mode, the younger file number is always assigned to the multitrack file. In the example above, 001 is assigned to the multitrack file, while 002 is assigned to 1 or 2 track file.

Recording digital audio

Before executing recording of digital audio, you have to make the following settings besides record track selection.

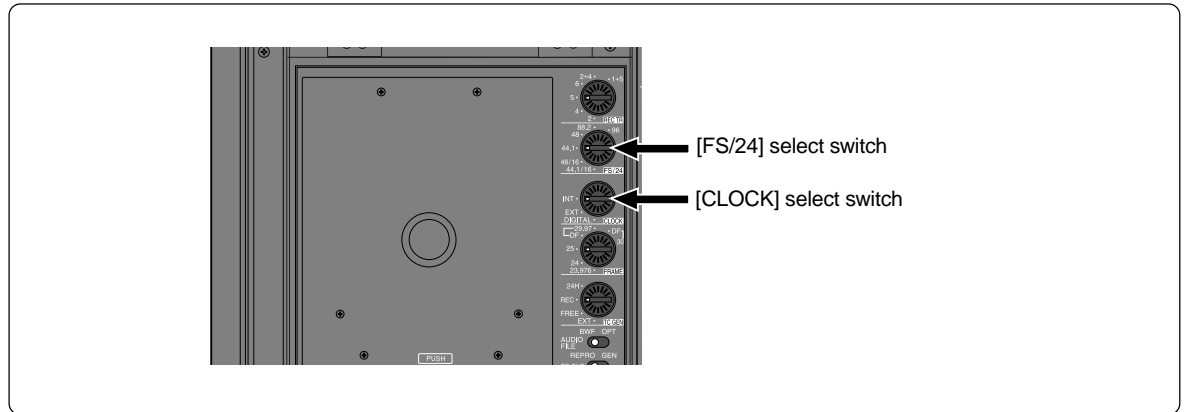

Selecting digital input channels

By default, the digital inputs are selected as channel sources for all channels (1 through 6). Therefore, when each pair channels (1-2, 3-4 and 5-6) receive digital input signal which is locked, they accept it and allow to make digital recording. If the digital input signal is not locked, the analog input is automatically selected.

<Note>

Using the “Digital in” menu in the Setup mode, you can select the input sources between digital and analog for each input channel pair (1-2, 3-4 and 5-6). Therefore, it is possible to accept and record digital and analog sources simultaneously. For example, you can make channels 1 and 2 to accept digital signal, while channels 3 through 6 to accept analog signals. See “Chapter 7: Setup mode” on page 91 for details.

Selecting the sampling frequency

Set the [FS/24] select switch on the top panel appropriately to match the digital signal input.

Selecting the system master clock

Set the “CLOCK” switch on the top panel to “DIGITAL”.

When the [DIGITAL IN] connector receives the digital audio signal and the channel is locked, “DIG IN” is shown in the “CLK” field on the Normal screen, while the “DIGI” icon is shown above it (see the screen example below). If the input channel is not locked to the digital input, “INT” is shown on the display.

To synchronize the PD-6 to a video or word clock signal, set the [CLOCK] switch to “EXT”.

The PD-6 automatically select between the video and word clock. “VIDEO” is shown in the “CLK” field when it is locked to a video clock, while “WORD” is shown when it is locked to a word clock.

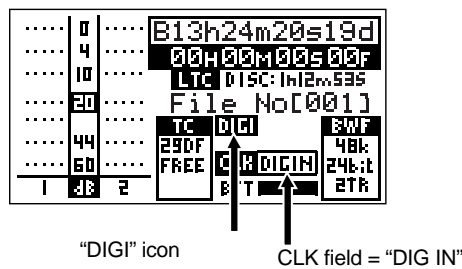

A time code is recorded according to the [TC GEN] select switch setting (see “Recording time code” in the following).

Recording time code

The PD-6 is equipped with the internal IEC time code generator/reader, which is used when recording internal time code together with audio. You can also record external time code, or the internal generator time code while jamming to external time code. Before recording time code, the following three switch settings are needed.

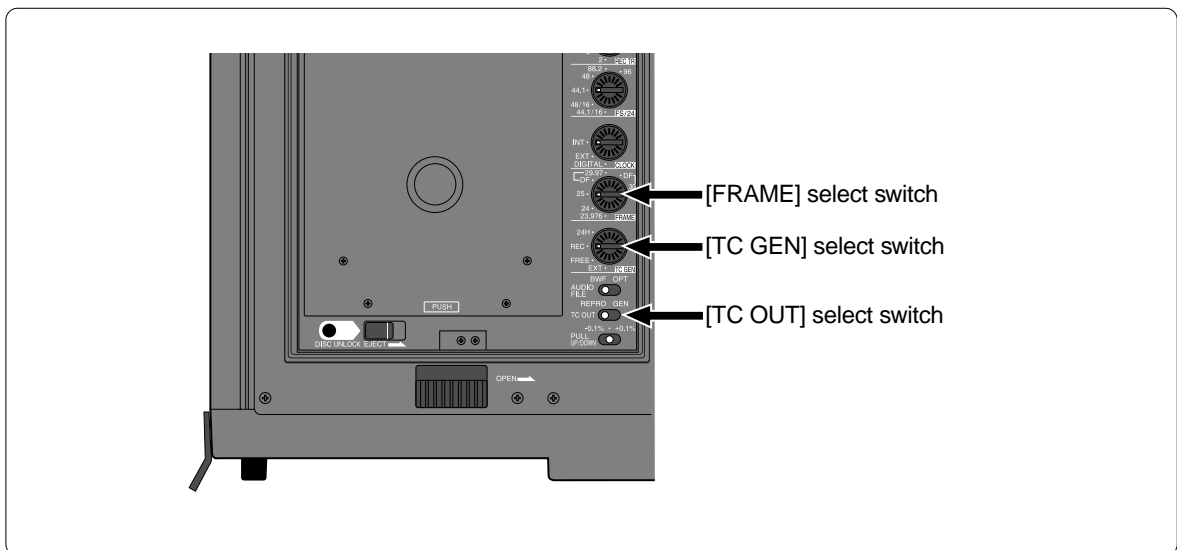

Selecting the TC frame rate

Using the [FRAME] switch, select a desired time code frame rate from among 23.976, 24, 25, 29.97, 29.97DF, 30DF and 30. The time code is recorded with the selected frame rate.

<Note>

When the frame rate is set to “29.97” or “30DF”, the time code does not agree with clock time and slips off at the rate of 3.6 seconds per hour. Also note that, when selecting either of these frame rates, the time code continuity cannot be obtained when it passes through “24h00m00s00f”, according to the nature of the EIAJ format time code.

<Note>

When recording external time code, you can check the external time code value and frame rate by switching the time display on the Normal screen to “LTC IN” using the [TIME] key (see the screen example below). If the external time code frame rate does not match the [FRAME] select switch setting, the frame rate shown on the screen flashes for warning. In this case, set the [FRAME] select switch appropriately to match the external time code.

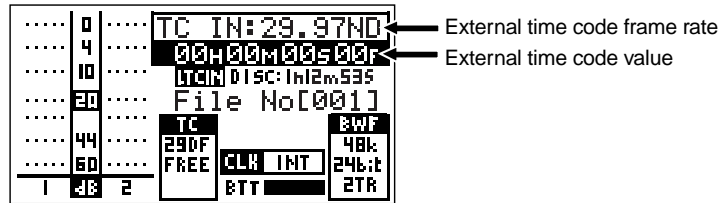

Selecting the TC generate mode

Use the [TC GEN] select switch to select the generator mode for time code recording from among “24H RUN”, “REC RUN”, “FREE RUN” and “EXT RUN”.

24H RUN	Time code starts from the internal RTC (real-time clock) data.
REC RUN	When recording to a new file, the generator records time code from the value which continues to the last time code value of the previous audio disk. When recording to a new disk which has no audio file after exchanging a disk, the generator records time code from the value which continues to the last time code value of the previous disk used before disk exchange.
FREE RUN	Runs the internal generator by the free run mode, and records the current internal generator time as the start time.
EXT RUN	Records an incoming external time code value as the start time.

Setting the time code output

Use the [TC OUT] switch to select the time code source (REPRO or GEN) fed from the [TIME CODE OUT] connector.

REPRO	Outputs time code recorded on the disk.
GEN	Outputs the internal generator time code.

<Notes>

- By setting the [TC OUT] switch to “GEN”, the [TIME CODE OUT] connector can output the internal generator time code only when the generator is running with the [TC GEN] switch set to “FREE RUN” or with the switch set to [REC RUN] or [24H RUN] during recording.
- See “Chapter 6: TC Setup mode” on page 81 for details about the LTC start time, TC user bit editing, internal TC generator start time setting, the generator user bit setting, etc.

Jam function

The jam function of the PD-6 internal generator allows to take over generating time code after the generator locks to the external time code timing.

Using the PD-6 jam function, the PD-6 time code generator can run with extreme accuracy (its own crystal accuracy) after it locks to the external time code. Therefore, you can make PD-6 recording in sync with the VTR even if you disconnect the time code input after the PD-6 generator locks to the external time code. In other words, you can use the PD-6 away from the VTR, which is essential for location recording.

The jam function is available only when the [TC GEN] select switch is set to “FREE RUN”.

The table below shows how the PD-6 reacts depending on the [TC GEN] switch setting when you set the [JAM] switch to “ON”.

24H RUN	Invalid (“Void!” is shown).
REC RUN	Invalid (“Void!” is shown).
FREE RUN	When receiving external time code, the internal generator can jam to it. The user bit of the external time code is copied and maintained. Runs the internal generator by the free run mode, and records the current internal generator time as the start time.
EXT RUN	Invalid (“Void!” is shown).

- Before activating the jam function, check that the following conditions are satisfied.
 1. The [TIME CODE IN] connector is receiving external time code.
 2. The time display on the Normal screen is set to “LTC IN” and external time code value is shown.
 3. The external time code frame rate matches the [FRAME] select switch setting. Otherwise, if you try to activate the jam function, “Illegal Frame!” is shown on the display and the operation is ignored.
- The following shows the basic jam operation procedure.
 1. Feed external time code from a VTR, etc. to the [TIME CODED IN] connector.
 2. Set the [JAM] switch to “ON”.
The display shows “—Force JAM!—” and the internal generator takes over generating time code.
 3. Cut off the external time code from the [TIME CODE IN] connector.
 - Set the “Jam mode” menu in the TC Setup mode if required (see “TC Setup mode” on page 86 for details).

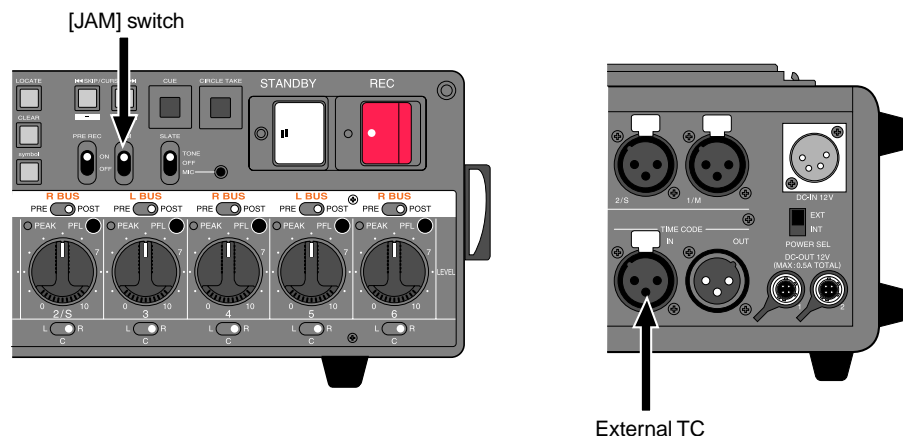

Creating cue points

The PD-6 provides the following three ways of creating a cue point. Each cue point can be used as a marker.

1. A cue point is automatically created at the recording start point (only for a “Tape” mode disk).
2. During audio recording, you can create a cue point “on-the-fly” at the desired point.
3. You can create a cue point using the cue point list on the screen.

Creating a cue point automatically at the recording start point

To create a cue point at the beginning of recording automatically, set the “Auto cue” menu setting in the Setup mode to “On” (the default setting is “Off”).

When it is set to “On”, a cue point (01) is automatically created at the beginning of recording when recording is made to a “Tape” mode disk.

See page 95 for details about the “Auto cue” menu in the Setup mode.

<Note>

You can automatically create a cue point only when using a “Tape” mode disk. With a “Normal” mode disk, you cannot create a cue point at the beginning of recording automatically.

Creating a cue point on-the-fly

You can create a “cue point” at the point you press the [CUE] key during recording. Up to 99 cue points can be created.

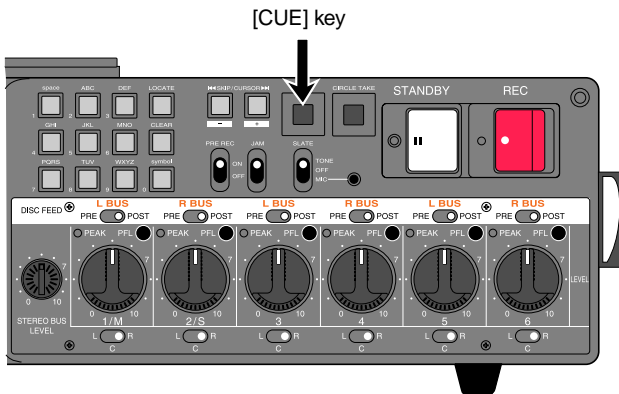

If you press the [CUE] key during recording, a cue point holding the current time value is created, while “Cue:**Stored!” (** is a cue number) and the time value are briefly shown on the screen. The least number unused for the existing cue numbers is assigned to the cue number automatically.

You can edit the label of a cue point, edit the cue position (time data) or delete a cue point. Cue points can be used for locate and skip functions.

Viewing the cue point list

Pressing the [CUE] key while the recorder is stopped brings up the CUE LIST screen as shown below. In this screen, the existing cue points are listed. You can scroll the list by using the [SEL] dial or [◀◀ SKIP/CURSOR ▶▶] key.

```

CUE LIST▶ (LTC)
01 Cue 01 00h22m34
02 Cue 02 00h51m20
03 Cue 03 01h25m08
04 Cue 04 01h40m11
05          --h--m--
06          --h--m--
    
```

In the screen example above, cue points 1 through 4 are created, while no data is stored on and after cue point 5. The time data is shown by the time display mode before bringing up this screen (in the above example, by the LTC mode).

Editing a cue point

By selecting a desired cue point on the CUE LIST screen, you can edit its label, edit its position (time data) or delete it.

Highlight a desired cue point and press the [ENTER] key. The display changes to show the edit screen for the selected cue point. By default, "Label" flashes on the screen.

```

CUE LIST▶Edit▶ (LTC)
---CUE No.02 Edit---
Label[Cue 02
]
<Position>
00h51m20s10f10sf
<Delete>
    
```

• Editing a label

To edit a cue point label, press the [ENTER] key when "Label" flashes. The first character of the current label flashes, showing that you can now edit it. Use the [SEL] dial (or numeric keys) to select the desired character and press the [ENTER] key.

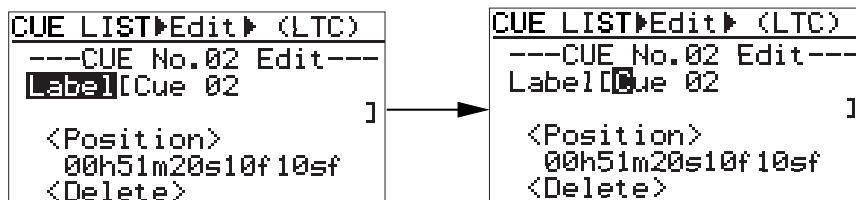

Use the [◀◀ SKIP/CURSOR ▶▶] key to move the cursor. When using the numeric keys for entering characters, pressing any other numeric key moves the cursor to the right automatically.

<Note>
 Pressing the [CLEAR] key deletes the flashing character.
 To delete the whole label, press the [CLEAR] key repeatedly when the first character flashes.

• Editing time data

To edit time data, select “Position” using the [SEL] dial and press the [ENTER] key. The subframe value of the current time data flashes, showing that you can now edit it.

Select the edit point using the [◀ SKIP/CURSOR ▶] key, edit the value using the [SEL] dial, and confirm the setting by pressing the [ENTER] key.

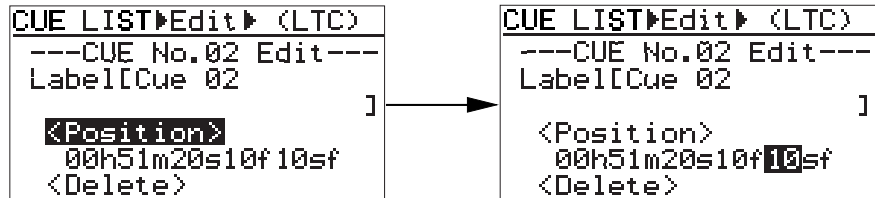

<Note>
Pressing the [CLEAR] key resets the time value to zero (00h 00m 00s 00f 00sf).

• Deleting a cue point

To delete an unnecessary cue point, select “Delete” using the [SEL] dial and press the [ENTER] key (“Sure?” flashes).

Press the [ENTER] key to delete the cue point from the list.

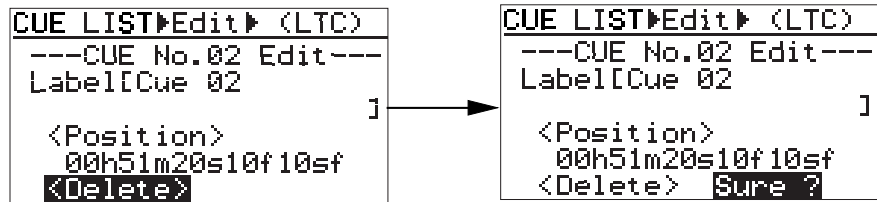

<Note>
After deleting a cue point, the label column of the cue point becomes empty while the time value column shows “-h-m-s-f-”.

Creating a new cue point using the cue list screen

Using the CUE LIST screen, you can create a new cue point.

Select a desired cue number which does not hold data.

By pressing the [ENTER] key, time data of the current recorder position is stored as the cue point.

In the example below, Cue 5 is created when the current recorder position is “01h58m20s**f**sf” (LTC time).

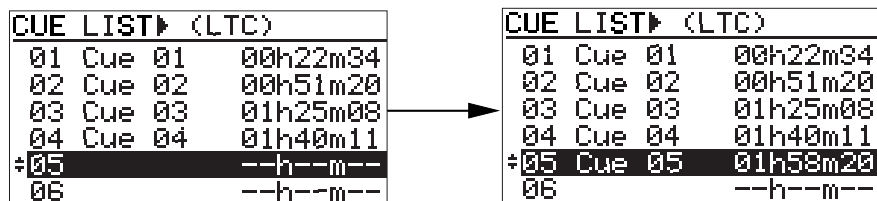

Playback

Normal audio playback

1. **Make sure that a recorded disk is set to the tray.**
2. **Load a desired audio file.**
You can select an audio file from the FILE SEL screen or using the [◀◀ SKIP/CURSOR ▶▶] key.

<Selecting a file from the FILE SEL screen>

Pressing the [FILE SEL] key brings up the FILE SEL screen, on which all audio files recorded on the current disk is shown.

[FNO]	[FILE NAME]
001	Action-001.wav
002	Action-002.wav
003	Action-003.wav
004	Action-004.wav
005	Action-005.wav

You can load a desired audio file by selecting the file using the [SEL] dial followed by pressing the [ENTER] key.

When an audio file is loaded, the display shows the beginning of the file.

When an audio file is loaded, the display shows the Normal screen, on which the time display field shows the beginning of the file.]

<Selecting a file using the [◀◀ SKIP/CURSOR ▶▶] key>

By setting the “Skip mode” menu in the Setup mode to “File”, you can select a desired file using the [◀◀ SKIP/CURSOR ▶▶] key.

By pressing the [◀◀ SKIP/CURSOR ▶▶] key while the recorder is stopped, you can skip forward or backward a file. See “Skip/locate functions” on page 78 and “Setup mode” on page 92 for details.

3. **Press the [PLAY] key to start playback.**
The play indicator is lit.
4. **To monitor the playback sound, use headphones or the internal speaker.**
For details about how to get the monitor sound, see page 64.
5. **To stop playback, press the [STOP] (or [STANDBY]) key.**

<Notes>

- If the Fs or (and) bit length of a playback file does not match the [FS/24] select switch setting, the FS or (and) bit length indication on the Normal screen flashes. In this case, set the [FS/24] select switch to the appropriate position to match the file.
- If you stop playback using the [STANDBY] key, the recorder goes into the pause mode. The pause mode is automatically released after the pause release time has passed.
You can set the pause release time using the “Pause time” menu in the Setup mode (see page 95). The default setting is three minutes.

• Playback of a file recorded in two-file mode

When playing back either one of two files recorded in two-file mode (“2+4” or “1+5”), the output assignment of the [ANALOG LINE OUT] connectors depends on the [REC TR] select switch position. The following table shows the relation between the track numbers (TR1 through TR6) of [ANALOG LINE OUT] connectors and the [REC TR] select switch position for each mode.

• When playing back either one of two files recorded in the “2+4” mode	
“2+4” position	When playing back the 2-track file, the signals are output from the “TR1” and “TR2” connectors. When playing back the 4-track file, the signals are output from the “TR3” through “TR6” connectors.
Other than “2+4” position	When playing back the 2-track file, the signals are output from the “TR1” and “TR2” connectors. When playing back the 4-track file, the signals are output from the “TR1” through “TR4” connectors.
• When playing back either one of two files recorded in the “1+5” mode	
“1+5” position	When playing back the mono-track file, the signal is output from the “TR1” connector. When playing back the 5-track file, the signals are output from the “TR2” through “TR6” connectors.
Other than “1+5” position	When playing back the mono-track file, the signal is output from the “TR1” connectors. When playing back the 5-track file, the signals are output from the “TR1” through “TR5” connectors.

<Note>
You cannot play back both of two files recorded in two-file mode simultaneously.

Time code playback

Recorded time code is played back together with audio and can be output from the [TIME CODE OUT] connector.

To output recorded time code from the [TIME CODE OUT] connector, set the [TC OUT] switch on the top panel to “REPRO”.

You can also make setting of the following menus in the TC Setup mode according to the situation.

1. **LTC start time setting (using the “Edit LTC start” menu)**
2. **TC output setting while paused (using the “Pause TC” menu)**
3. **Repro TC user bit setting (using the “TC Ubit” menu)**

* See “Chapter 6: TC Setup mode” on page 81 for details about the TC Setup mode.

<Note>
If the [TC OUT] switch is set to “GEN”, always the internal TC generator time code is output from the [TIME CODE OUT] connector.

Cueing playback

In the cue mode, forward or backward cueing (at up to 2 x speed) is possible. During playback, pressing the [F FWD] (or [REW]) key enters the cue mode. The cueing speed gradually gets faster unit it reaches the 2 x speed. To cancel the cue mode, press the [PLAY] mode.

Skip/locate functions

The PD-6 offers comprehensive skip/locate functions.

Skipping by file

When more than one audio file is created on the current disk, you can quickly skip to the beginning (ABS 0) of a desired track.

By pressing the ◀◀ or ▶▶ ([SKIP/CURSOR]) keys while the recorder is stopped, you can skip forward or backward a file. Therefore, pressing the ◀◀ or ▶▶ key as many times as required skips to the beginning of the desired file.

<Note>

To skip by file when pressing the ◀◀ or ▶▶ key, the “Skip mode” menu in the Setup mode must be set to “File”. The default setting is “File”. If it is set to “CUE”, change the setting.

Skipping by cue point

You can quickly skip to a desired cue point on the current audio file.

By pressing the ◀◀ or ▶▶ ([SKIP/CURSOR]) keys while the recorder is stopped, you can skip to the next or previous cue point. Therefore, pressing the ◀◀ or ▶▶ key as many times as required skips to the desired cue point.

<Note>

To skip by cue when pressing the ◀◀ or ▶▶ key, the “Skip mode” menu in the Setup mode must be set to “CUE”. The default setting is “File”, so change the setting to “CUE”.

Locating to the beginning (ABS 0) of a file

While the recorder is stopped, pressing the [REW] key while holding down the [STOP] key locates to the beginning (ABS 0) of the current file quickly.

Locating to the end (REC END) of a file

While the recorder is stopped, pressing the [F FWD] key while holding down the [STOP] key locates to the record end position (REC END) of the current file quickly.

Locating to the previous locate point

While the recorder is stopped, pressing the [LOCATE] key locates to the position where you located last time.

Locating to the desired time

You can locate the recorder to the desired position by specifying the time value.

1. **While the recorder is stopped, press any one of numeric keys.**
The PD-6 enters the time edit mode, while the TIME EDIT screen appears on the LCD display.



<Note>

The time value can be specified according to the time display mode selected before entering the time edit mode. In the screen example above, you can specify the time value based on LTC.

2. **Enter the desired time value using the [SEL] dial (or numeric keys).**
You can move the field to be edited using the [◀ SKIP/CURSOR ▶] keys. Pressing the [CLEAR] key clears the time value to zero.
3. **After entering desired value to all fields, press the [LOCATE] key.**
The recorder quickly locates to the position at the specified time.

Locating to the desired cue point

You can locate the recorder quickly to a desired cue point by selecting the cue point from the cue list.

1. **While the recorder is stopped (or playing back), press the [CUE] key.**
The CUE LIST screen appears.

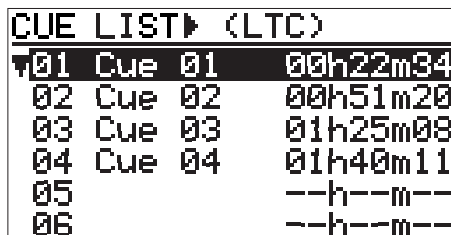

2. **Select (highlight) the desired cue point from the cue list using the [SEL] dial (or the [◀ SKIP/CURSOR ▶] keys), and press the [LOCATE] key.**
The recorder quickly locates to the cue point.

<Note>

Regardless of the "Skip mode" menu setting, you can always locate to the desired cue point by using this function.

Chapter 6: TC Setup mode

This chapter describes details about each menu available in the TC Setup mode. In the TC Setup mode, you can:

1. Check and edit the LTC start reference time at ABS 0.
2. Select whether the PD-6 outputs time code or not while the recorder is paused.
3. Select user bit of output time code when the [TC OUT] switch is set to "REPRO".
4. Check the internal time code generator status and edit the start time and user bit.
5. Select the user bit of output time code when the [TC OUT] switch is set to "GEN".
6. Set the jam mode when the internal time code generator is in the "FREE RUN" mode.

<Table of contents>

How to select the TC Setup menu	82
Editing the LTC start time	82
Time code output while paused	83
User bit setting of playback time code	84
Editing the internal time code generator setting	85
User bit setting of internal generator time code	86
Jam mode setting	86

How to select the TC Setup menu

- When the [SHIFT] indicator is lit, press the [CONTRAST/TC SETUP] key.**
 The PD-6 enters the TC Setup mode, while the display shows the TC SETUP screen as below by default.
 This screen is the primary layer screen and shows the menu list.
 Some menu has “▶” on the right. This indicates you can enter the dedicated screen of the menu.

```

TC SETUP▶
Edit LTC start▶
Pause TC: Off
TC Ubit: EEEEEERRR
Set Gen.TC▶
Gen Ubit: <User>
JAM mode: BOTH
    
```

- Select the desired menu using the [SEL] dial and press the [ENTER] key.**
 You can now set or edit the selected menu.
 In the following description, we assume that the TC SETUP (primary) screen is shown on the display.

Editing the LTC start time

You can set the desired LTC start time corresponding to the beginning (ABS 0) of an audio file.

<Note>
 PD-6 records only the start time of LTC, and the internal generator generates and outputs LTC with reference to the start time.
 With a “BWF” file, the start time is recorded as “Time Reference” in “Broadcast Audio Extension Chunk”.

- Select the “Edit LTC start ▶” menu and press the [ENTER] key.**
 The current LTC start time is shown.

<pre> TC SETUP▶ Edit LTC start▶ Pause TC: Off TC Ubit: EEEEEERRR Set Gen.TC▶ Gen Ubit: DDDMMYYFF JAM mode: BOTH </pre>	→	<pre> TC SETUP▶LTC Start --LOOKUP LTC START-- **H**M**s**f **sr Edit: ENTER key Exit: EXIT key </pre>
--	---	---

If you just check the current LTC start time without editing the time, press the [EXIT] key to exit the TC Setup mode. To edit the LTC start time, go to the next procedure.

- Press the [ENTER] key.**
 Initially, the subframe value flashes and you can now edit the subframe of LTC start time.

<pre> TC SETUP▶LTC Start --LOOKUP LTC START-- **H**M**s**f **sr Edit: ENTER key Exit: EXIT key </pre>	→	<pre> TC SETUP▶LTC Start ---EDIT LTC START--- **H**M**s**f sr Rewrite: ENTER key Exit: EXIT key </pre>	flashing
---	---	--	----------

3. **Use the [SEL] dial (or the numeric keys) to enter the desired start time.**
 You can select the flashing digit (to be edited) using the [◀◀ SKIP/CURSOR ▶▶] keys. The start time can be set between “00H: 00M: 00S: 00F: 00SF” and “23H: 59M: 59S: **F: 99SF” (** is one less than the frame rate value).
4. **After editing the start time, press the [ENTER] key to confirm the setting.**
5. **Press the [EXIT] key to exit the TC Setup mode.**
 You can see the edited LTC start time reflected when switching the display to “LTC”.

Time code output while paused

This menu select whether time code is output from the [TIME CODE OUT] connector or not while the recorder is paused.

1. **Select the “Pause TC: ***” menu and press the [ENTER] key.**
 The current setting (“On” or “Off”) flashes (the default setting is “Off”).

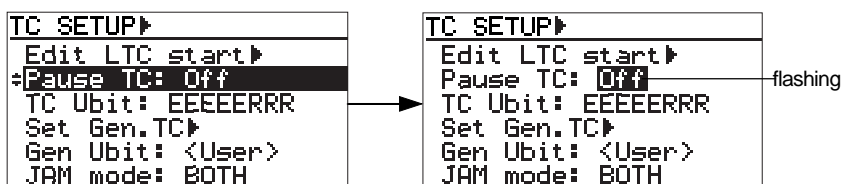

2. **Use the [SEL] dial to select “On” or “Off” and press the [ENTER] key to confirm the selection.**

On	When the [TC OUT] select switch is set to “REPRO” and the recorder is stopped (or paused), time code of the same value is output intermittently.
Off	When the [TC OUT] select switch is set to “REPRO” and the recorder is stopped (or paused), no time code is output.

3. **Press the [EXIT] key to exit the TC Setup mode.**

User bit setting of playback time code

You can select the desired user bit of time code which is output from the [TIME CODE OUT] connector while the [TC OUT] is set to “REPRO”.

1. **Select the “TC Ubit: *****” menu and press the [ENTER] key.**
The currently selected user bit flashes (the default setting is “EEEEERRR”).

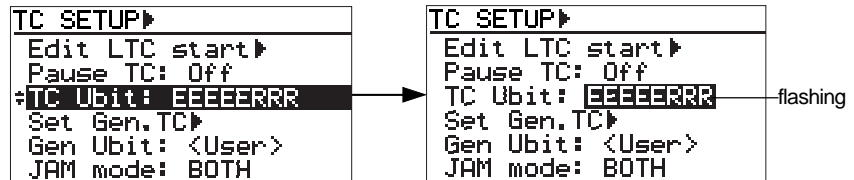

2. **Use the [SEL] dial to select the desired user bit and press the [ENTER] key to confirm the selection.**

EEEEERRR	BG_76543:EEEEEE / BG_210:RRR
MMDDYYff	BG_76:MM (month)/ BG_54:DD (day)/ BG_32:YY (year)/ BG_10:ff (US)
DDMMYYff	BG_76:DD (day)/ BG_54:MM (month)/ BG_32:YY (year)/ BG_10:ff (EUR)
SSSSSSRR	BG_765432:SSSSSS / BG_10:RR
RRREEEEE	BG_756:RRR / BG_54321:EEEEEE
SSSSSSTT	BG_765432:SSSSSS / BG_01:TT
<BWF UBIT>	Outputs the user bit of BWF descriptor information

EEEEEE:EVENT No
Only the lower five figures of the numeral information in the event information recorded on BWF are output from the rightmost five digits of the user bit fields.

RRR:REEL No
Only the lower three figures of the reel number recorded on BWF are output from the rightmost three digits of the user bit fields.

RR:REEL No
Only the lower two figures of the the reel number recorded on BWF are output from the rightmost two digits of the user bit fields.

SSSSSS:SCENE No
Only the lower six figures of the scene number recorded on BWF are output from the rightmost six digits of the user bit fields.

TT:Take No
Only the lower two figures of the take number recorded on BWF are output from the rightmost two digits of the user bit fields.

ff:File No (in decimal, 01 to 99)

<Notes>

- Date information shows the original date of an audio file.
- To output the event number, reel number, scene number, and take number, it must be set in the Setup mode in advance.

3. **Press the [EXIT] key to exit the TC Setup mode.**

Editing the internal time code generator setting

You can check the generator mode, time code value and user bit of the internal time code generator, as well as can edit the time code start time for the “FREE RUN” or “REC RUN” mode and the user bit for the “FREE RUN” mode.

1. **Select the “Set Gen.TC ▶” menu and press the [ENTER] key.**

The display shows the current internal time code generator setting information (generator mode, TC start time and user bit), which can be edited.

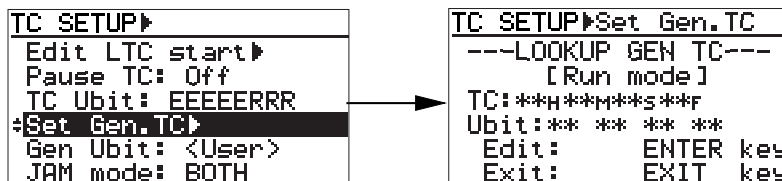

<Notes>

- In the field where “[Run mode]” is shown on the upper left screen example, the current generator mode (“FREE RUN”, “REC RUN”, “24H RUN” or “EXT RUN”) is shown.
- If no time code is fed to the PD-6 in the “EXT RUN” mode, “<<EXT TC Non!>>” is shown.
- In the “REC RUN” or “24H RUN” mode, user bit is not shown.

If you just check the information and do not make any editing, press the [EXIT] key to exit the TC Setup mode.

Only when the time code generator mode is set to “FREE RUN”, “REC RUN” or “24H RUN”, you can edit the start time by the procedure below.

2. **Press the [ENTER] key.**

The frame value of time code starts flashing. You can now edit the start time of the internal time code generator.

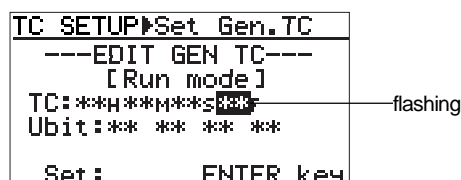

3. **Use the [◀◀ SKIP/CURSOR ▶▶] keys to move the edit position between the time digits and use the [SEL] dial (or the numeric keys) to enter a desired value.**

After entering the whole time code value, press the [ENTER] key to confirm the setting. Pressing the [CLEAR] key clears the time value to zero.

<Notes>

- Only when the time code generator mode is set to “FREE RUN” and the “Gen Ubit” menu is set to “<user>”, you can also edit the user bit on this screen. In this condition, after step 2 above, you can use the [◀◀ SKIP/CURSOR ▶▶] keys to moves the cursor position among the “TC” and “Ubit” digits. So use the similar manner as described in step 3 above to edit “TC” and “Ubit”, then press the [ENTER] key to confirm all the setting.
- After editing the generator start time, recording to a new file in the “REC RUN” mode starts from the new start time.

4. **Press the [EXIT] key to exit the TC Setup mode.**

User bit setting of internal generator time code

You can set the time code user bit of the internal generator, which is output from the [TIME CODE OUT] connector when the [TC OUT] switch is set to "GEN".

1. **Select the "Gen Ubit: *****" menu and press the [ENTER] key.**
The display shows the current internal time code generator setting information, in which the currently selected user bit output mode flashes (the default mode is <User>:00 00 00 00).

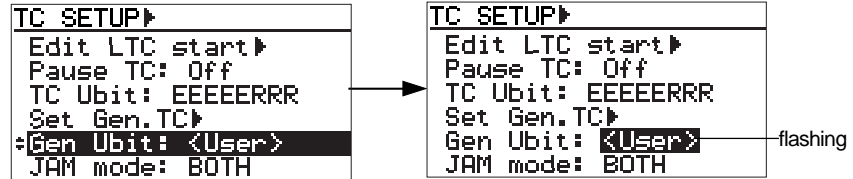

2. **Use the [SEL] dial to select the desired user bit, and press the [ENTER] key.**

<User>	the default is 00 00 00 00.
MMDDYYxx	BG_76:MM (month)/ BG_54:DD (day)/ BG_32:YY (year)/ BG_10:ff (US)
DDMMYYxx	BG_76:DD (day)/ BG_54:MM (month)/ BG_32:YY (year)/ BG_10:ff (EUR)

3. **Press the [EXIT] key to exit the TC Setup mode.**

Jam mode setting

You can set the jam mode which determines what information is jammed.

1. **Select the "JAM mode: *****" menu and press the [ENTER] key.**
The display shows the current internal time code generator setting information, in which the jam mode flashes (the default mode is "BOTH").

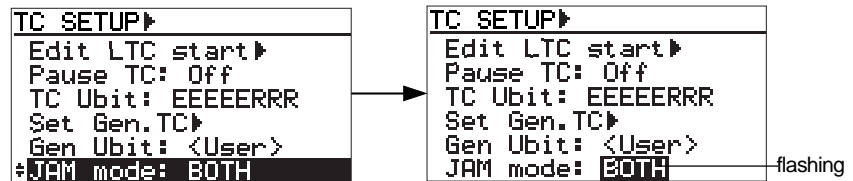

2. **Use the [SEL] dial to select the desired mode, and press the [ENTER] key.**

BOTH	Both time code and user bit are jammed.
TC	Only time code is jammed. For the user bit, the PD-6 internal data is used.
UBIT	Only the user bit is jammed. For the time code, the PD-6 internal data is used.

3. **Press the [EXIT] key to exit the TC Setup mode.**

Chapter 7: Setup mode

This chapter describes details about each menu in the Setup mode. These menus mainly set preferences.

<Table of contents>

Setup menu details	88
How to select a Setup menu	89
How to make Setup menu setting	90
Adjusting the real-time clock (Adjust RTC)	90
Setting the digital out format (Digital out)	91
Digital input channel setting (Digital in)	91
Skip mode setting (Skip mode)	92
Diagnoses on/off setting (Diagnoses)	92
Reference level setting (Reference level)	93
Peak hold time setting (Peak hold)	93
Slate tone recording time and mode setting (Tone rec mode)	94
Auto cue mode on/off setting (Auto cue)	95
Pause cancel time setting (Pause time)	95
Error tone output setting (Error tone)	96
Battery warning setting (BATT warning)	97
Speaker mute on/off setting (Speaker mute)	97
Limiter parameter setting (Limiter parameter)	98
Default file name setting (Default file name)	99
Default track name setting (Default track name)	100
Next event number setting (Next event No.)	100
USB keyboard type setting (Keyboard)	101
Pre-record time setting (Pre rec time)	101
Setup data saving (Save user setup)	102
Setup data loading (Load user setup)	102
ROM version checking (Version)	103

Setup menu details

The following menus are available in the Setup mode. Note that the Setup mode menu may change when the PD-6 software is updated.

Setup menu	Parameter/options		Default
Real Time Clock setting	year, month, day, hour, minute, second		When shipped
Digital out setting	AES/EBU, SPDIF		AES/EBU
Digital In setting	Digital, Analog (set by pair channels : 1-2, 3-4, 5-6)		Digital
Skip mode setting	File, Cue		File
Diagnoses On/Off setting	On, Off		On
Reference level setting	-20 dB, -18 dB		-20 dB
Peak hold time setting	0 to 9 seconds, infinity		3 seconds
Tone rec mode setting	Tone rec time	1 to 30 seconds	10 seconds
	Tone rec ON/Off	Off, TONE, 4POP TONE	Off
Auto cue setting	On, Off		Off
Pause cancel time setting	0.1 to 9.9 minutes, infinity		3 minutes
Error tone setting	Write error	On, Off	On
	Input clip	On, Off	On
	BATT warning	On, Off	On
	Disk warning	Off, 1 min. to 9 min. (in 1 minute steps)	3 minutes
BATT warning setting	10.5 V to 13.0 V (in 0.5 V steps)		10.5 V
Speaker mute On/Off setting	On, Off		Off
Limiter parameter setting	Grouping	Mono, 1-2, 1-6	Mono
	Threshold	-6 dB, -12 dB	-12 dB
	Ratio	1:3, 1:5	1:3
Default File name setting	File name mode	Date, Take	Date
	Scene name	Up to 15 characters can be entered (available only when the "File name mode" is set to "Take").	-
	Take number	001 to 999 (available only when the "File name mode" is set to "Take")	-001
Default track name setting	TR1	Up to 16 characters can be entered.	track1
	TR2		track2
	TR3		track3
	TR4		track4
	TR5		track5
	TR6		track6
Next event number setting	00001 to 99999		00001
USB keyboard setting	US, JAPAN		US
Pre rec time setting	1 to 10 seconds		10 seconds
User setup data saving	Box 0 through 6		-
User setup data loading	Default setup, Box 0 through 6		-
Version checking	-		-

How to select a Setup menu

To select a desired Setup menu and make editing or carry out the operation, use the following keys and dial.

The [CLEAR] key is used for clearing characters after the cursor position when entering/editing a track name, scene name and user box label. See the appropriate section described later for details.

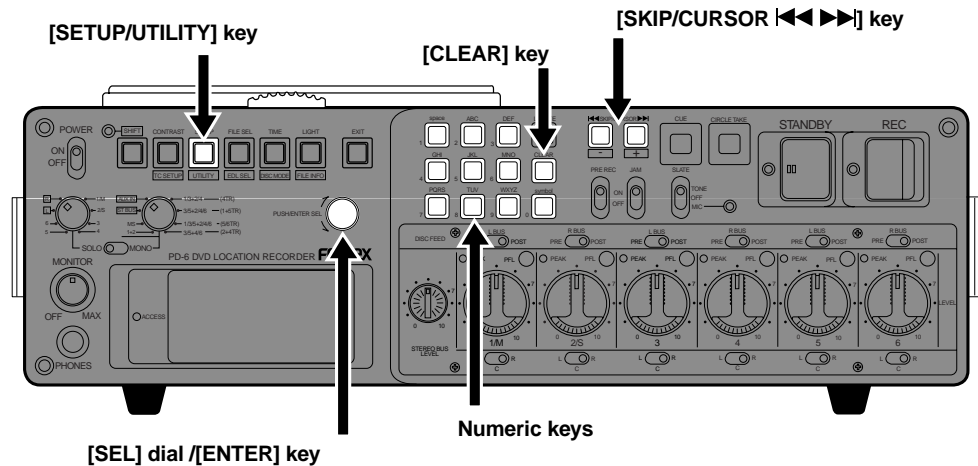

1. **When the [SHIFT] indicator is unlit, press the [SETUP/UTILITY] key.**
 The PD-6 enters the Setup mode and the display shows the primary SETUP screen on which you can select a menu.
 “▼” tells you that more menus are hidden under the screen currently shown.
 Some menu has “>” on the right. This indicates you can enter the dedicated screen(s) of the menu.

```

SETUP▶
▼Adjust RTC▶
Digital out: AES/EBU
Digital in▶
Skip mode: File
Diagnoses: On
Ref. level: -20dB
    
```

2. **Select the desired Setup menu using the [SEL] dial.**
 Under the “Ref. level” menu, the following menus are hidden.

```

Peak hold: 3sec
Tone rec mode▶
Auto cue: Off
Pause time: 0.2min
Error tone▶
BATT warning: 10.5V
Speaker mute: Off
Limiter Parameter▶
Default file name▶
Default track name▶
Next event No: 00001
Keyboard: US
Pre rec time: 10sec
Save user setup▶
Load user setup▶
Version▶
    
```

3. **Press the [ENTER] key.**
 Now you are ready for making editing or carrying out the operation.
 For details about the actual procedure for editing or operation, see the following description.

How to make Setup menu setting

Some Setup menus have the dedicated screens for editing, while others do not have the dedicated screens and can be edited on the primary screen. A menu of the former type has “▶” on the right, while a menu of the latter type does not have “▶”.

The following describes how to make settings of the “Adjust RTC” and “Digital out” menus as the examples of the former and latter types, respectively. You can make editing of each menu by the similar procedure as either of these examples.

Adjusting the real-time clock (Adjust RTC)

The “Adjust RTC” menu allows you to check and edit real-time clock data.

1. **Select the “Adjust RTC ▶” menu and press the [ENTER] key.**

The display changes to show the screen on which the current real-time clock is shown.

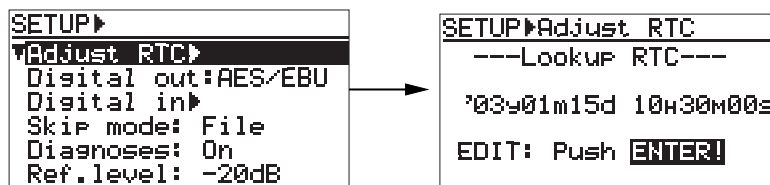

2. **To edit the current clock data, press the [ENTER] again.**

The second digits in the clock data flash. You are now able to edit the clock data.

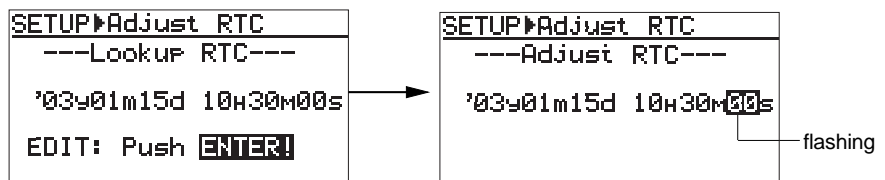

3. **Use the [SEL] dial (or the numeric keys) to enter the desired value at the cursor (flashing) position.**

You can move the cursor position using the [◀ SKIP/CURSOR ▶] keys. For each digit, you can enter the value within the range shown below.

Cursor position	Value range	Cursor position	Value range
“y” (year)	00 ~ 99	“H” (hour)	00 ~ 23
“m” (month)	01 ~ 12	“M” (minute)	00 ~ 59
“d” (day)	01 ~ 31	“S” (second)	00 ~ 59

4. **After editing the clock data, press the [ENTER] key to make the editing effective.**

<Note>

To set the clock precisely, set the clock data to a near future time and press the [ENTER] key synchronizing with the time signal.

5. **Press the [EXIT] key to exit the Setup mode.**

Setting the digital out format (Digital out)

The “Digital out” menu allows you to select the digital signal format (AES/EBU or S/P DIF) of the signal fed from the outputs of the [DIGITAL I/O] connector.

1. **Select the “Digital out: *****” menu and press the [ENTER] key.**
The currently selected option flashes (the default selection is “AES/EBU”). You are now able to select the option.

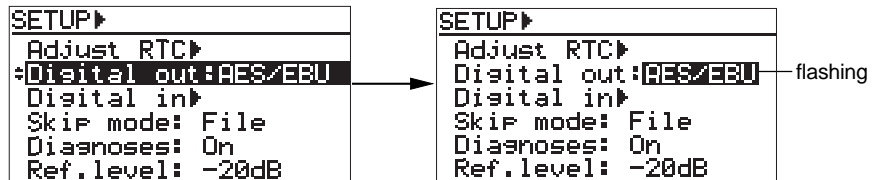

2. **Use the [SEL] dial to select the desired format (AES/EBU or S/P DIF), and then press the [ENTER] key.**

AES/EBU	A digital signal is output by the IEC 60958 (AES/EBU) format.
SPDIF	A digital signal is output by the IEC 60958 (S/P DIF) format.

3. **Press the [EXIT] key to exit the Setup mode.**

Digital input channel setting (Digital in)

The “Digital in” menu selects the input channel sources between digital and analog in two channel pairs (channels 1-2, 3-4 and 5-6).

On the “Digital in” menu screen, select the channels to be edited, press the [ENTER] key, and then select “Digital” or “Analog”.

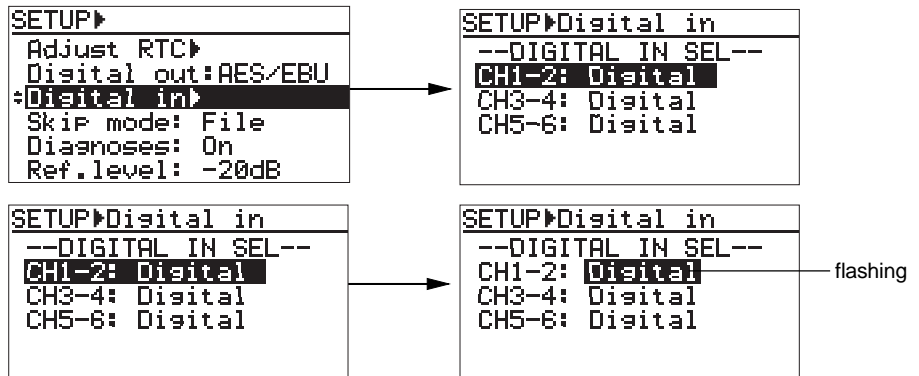

Channels	Option	Default
CH1-2	Digital or Analog	Digital
CH3-4	Digital or Analog	Digital
CH5-6	Digital or Analog	Digital

<Note>
You can make digital recording to channels which select “digital” in the “Digital in” menu when the channels lock to a correct digital clock. If the channels do not lock to a digital clock, the analog inputs are selected automatically regardless of the “Digital in” setting. The digital input signal format (AES/EBU or S/P DIF) is automatically detected by the PD-6.

Skip mode setting (Skip mode)

The “Skip mode” menu selects the function of the [◀◀ SKIP/CURSOR ▶▶] key. With the “Skip mode” menu, you can select “File” or “CUE”.

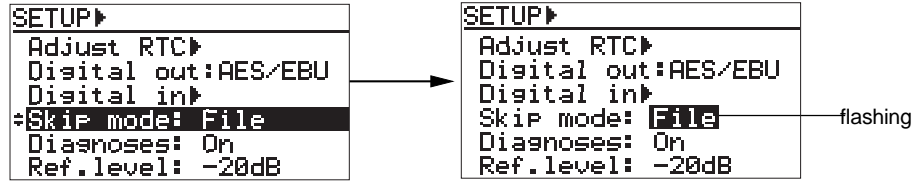

Option	Comment
File	You can select a desired audio file in order of created date using the [SKIP/CURSOR] key. (default setting)
CUE	You can skip to the previous (or next) cue point using the [SKIP/CURSOR] key.

Diagnoses on/off setting (Diagnoses)

The “Diagnoses” menu selects whether or not creating a diagnoses file which logs errors during recording, etc. With the “Diagnoses” menu, you can select “On” or “Off”.

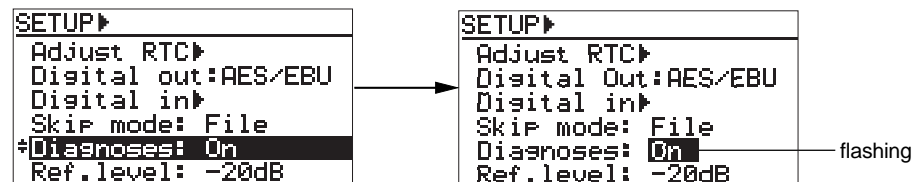

Option	Comment
On	Creates a diagnoses file which logs errors during recording, etc. (default setting)
Off	Does not create a diagnoses file.

Reference level setting (Reference level)

The “Reference level” menu selects the input reference level.

With the “Ref. level” menu, you can select “-20 dB” or “-18 dB”.

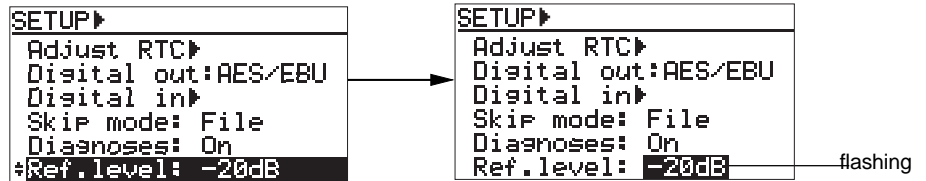

Option	Comment
-20dB	Sets the input reference level to -20 dB (default setting).
-18dB	Sets the input reference level to -18 dB.

The reference level setting is reflected to the level meter on the display.

When the reference level is set to “-20 dB”.

When the reference level is set to “-18 dB”.

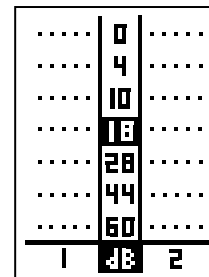
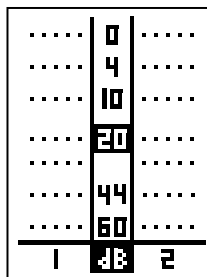

Peak hold time setting (Peak hold)

The “Peak hold” menu sets the peak hold time.

With the “Peak hold” menu, you can set the peak hold time between 0 and 9 seconds (or infinity).

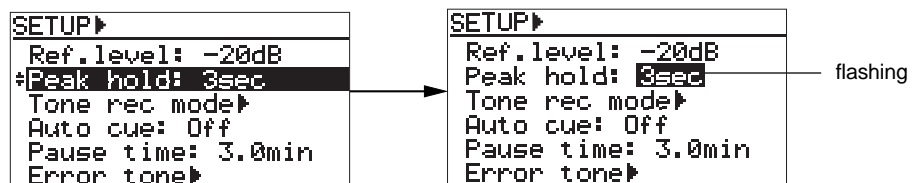

Option	Comment
0 to 9 seconds	You can set the time in one second steps (the default setting is 3 seconds).
Infinity	The infinity setting keeps holding the peak indication until pressing the [CLEAR] key.

Slate tone recording time and mode setting (Tone rec mode)

The “Tone rec mode” menu sets the recording time and mode of the slate tone which is recorded at the beginning of a file when recording is taken place in the New file mode.

On the “Tone rec mode” menu screen, you can set the recording time (Tone rec time) between 0 and 30 seconds, as well as the recording mode (Tone rec) from among “TONE”, “4POT TONE” and “Off”.

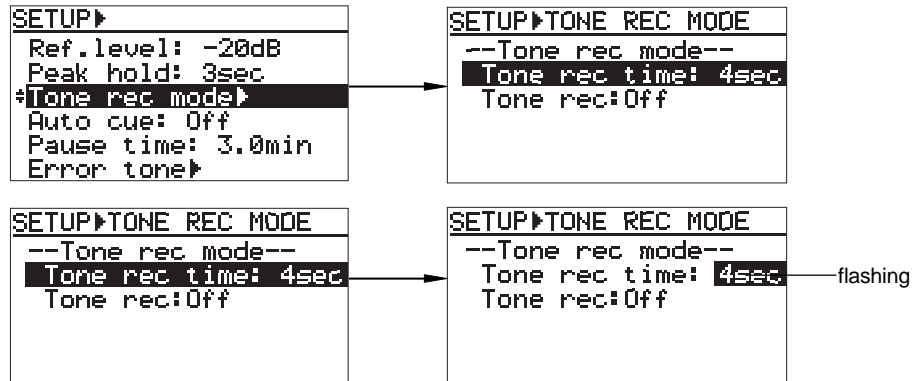

<Slate tone recording time> (Tone rec time)

Option	Comment
0 to 30 seconds	You can set the slate tone recording time in 1 second steps (the default setting is 10 seconds).

<Slate tone recording mode>

Option	Comment
Off (default)	Nothing is recorded.
TONE	The 1 kHz tone at the reference level is recorded for the duration of “Tone rec time”. While the slate tone is being recorded, you cannot record any external signal.
4POP TONE	Repeats four times the combination of recording the 1 kHz tone at the reference level for 0.5 second and muting for 0.5 second. While the slate tone is being recorded, you cannot record any external signal.

Auto cue mode on/off setting (Auto cue)

The “Auto cue” menu selects whether or not recording a cue point at the record start position automatically when making recording to a “Tape” mode disk.

With the “Auto cue” menu, you can select between “On” and “Off”.

<Note>

The auto cue function can be active only with a “Tape” mode disk. It is not active with a “Normal” mode disk.

<Note>

You can manually create a cue point at a desired position by using the [CUE] key (with either of a “Normal” or “Tape” mode disk).
You can edit created cue points or give labels to them.

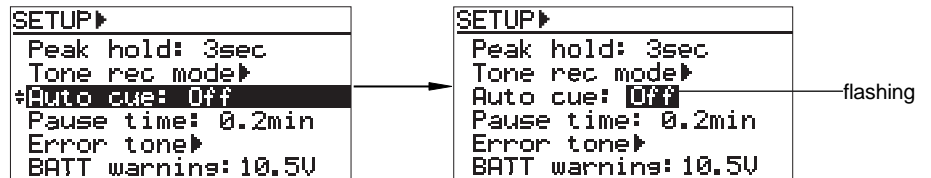

Option	Comment
Off (default)	A cue point is not automatically created at the record start position.
On	A cue point is automatically created at the record start position.

Pause cancel time setting (Pause time)

The “Pause time” menu sets the pause cancel time. After the pause cancel time has passed since the recorder entered the pause mode, the recorder automatically cancels the pause mode and stops.

With the “Pause time” menu, you can set the pause cancel time between 0 and 9 seconds (or infinity).

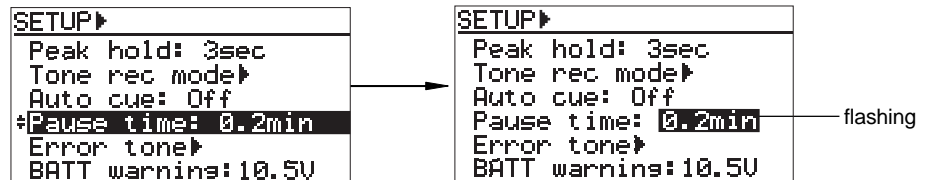

Option	Comment
0.1 to 9.9 minutes	You can set the time in 0.1 minute steps (the default setting is 3 seconds).
Infinity	The infinity setting maintains the pause mode until the “STOP” key is pressed.

<Note>

To save battery power, we recommend to set the time as short as possible.

Error tone output setting (Error tone)

The “Error tone” menu selects whether generating the error tone (warning tone) or not for each of four kinds of troubles (see below) independently. The error tone is generated from the internal monitor speaker (or headphones).

On the “Error tone” menu screen, you can select “On” or “Off” of the error tone for “Write error”, “Input clip” and “BATT warning”, as well as can set the time for “Disk warning”.

<Available conditions for generating the error tone>
 The name in the bracket at the end of each condition shows each item name of the Error tone menu.

1. A write error happens during recording. [Write error]
2. The peak indicator lights because of the input overload during recording. [Input clip]
3. The internal battery voltage drops below the level set by the “BATT warning” menu. [BATT warning]
4. The remaining recording time of a disk gets under the specified time. [Disk warning]

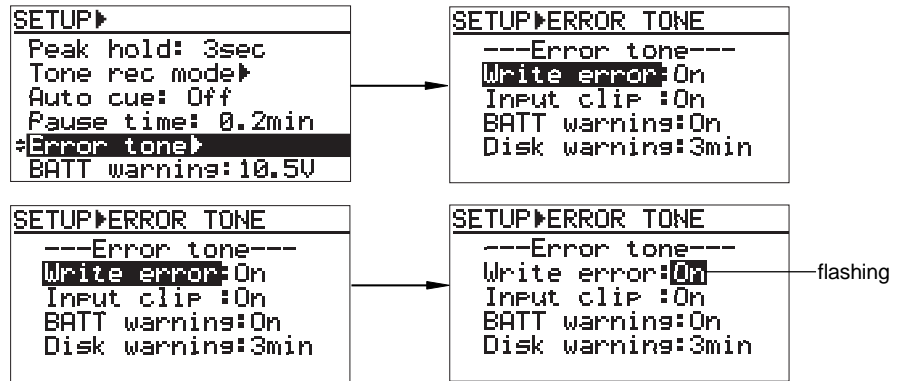

<Write error>

Option	Comment
Off	When the peak indicator lights because of the input overload during recording, the error tone is not generated.
On (default)	When the peak indicator lights because of the input overload during recording, the error tone is generated.

<Input clip>

Option	Comment
Off	When the peak indicator lights continuously because of the input overload, the error tone is not generated.
On (default)	When the peak indicator lights continuously because of the input overload, the error tone is generated.

<BATT warning>

Option	Comment
Off	When the internal battery voltage drops below the level set by the “BATT warning” menu, the error tone is not generated.
On (default)	When the internal battery voltage drops below the level set by the “BATT warning” menu, the error tone is generated.

<Disk warning>

Option	Comment
Off	When the remaining recording time of a disk gets under the specified time, the error tone is not generated.
1 to 9 minutes	When the remaining recording time of a disk gets under the specified time, the error tone is generated. (default setting is 3 minutes) The time can be set in 1 minute steps.

Battery warning setting (BATT warning)

The “BATT warning” menu sets the threshold of the battery power voltage for automatically ending recording or playback, releasing the disk lock or generating the error tone while the PD-6 is running with the internal battery.

To generate the error tone when the battery power voltage drops below the threshold, the “BATT warning” item in the “Error tone” menu must be set to “On”.

With the “BATT warning” menu, you can set the threshold between 10.5 V and 13.0 V.

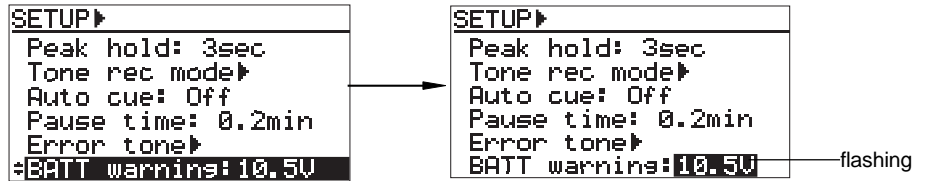

Option	Comment
10.5 V to 13.0 V (default: 10.5 V)	You can set the voltage in 0.5 V steps. The following settings are recommended depending on the battery used. 10.5 V: When a NiCd battery is used. 12.5 V: When a Lithium ion battery is used.

<Note>

If the actual voltage lowers the voltage set by the “BATT warning” item for more than one minute, the recorder automatically stops recording or playback, and releases the disk lock.

Speaker mute on/off setting (Speaker mute)

The “Speaker mute” menu selects whether muting the internal monitor speaker or not.

With the “BATT warning” menu, you can select “On” or “Off” for the monitor speaker mute.

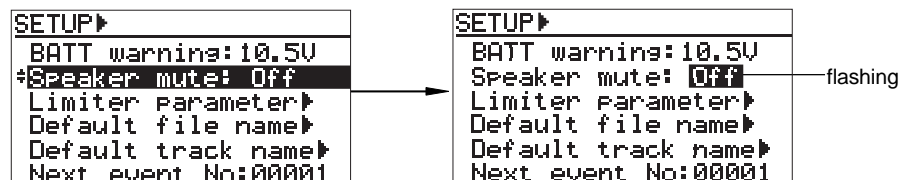

Option	Comment
Off (default)	The monitor speaker is not muted.
On	The monitor speaker is muted except during playback.

Limiter parameter setting (Limiter parameter)

The “Limiter parameter” menu makes parameter setting for the limiter.

On “Limiter parameter” menu screen, you can set “Grouping”, “Threshold” and “Ratio” parameters.

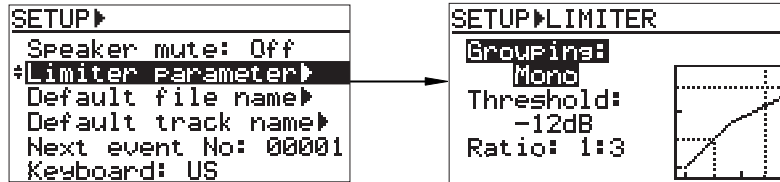

<“Grouping”>

Option	Comment
Mono	The limiter works for each channel independently. (default)
1-2	Channels 1 and 2 are grouped, and the limiter works the same for channels 1 and 2 according to the input levels of channels 1 and 2.
1-6	Channels 1 through 6 are grouped, and the limiter works the same for channels 1 and 6 according to the input levels of channels 1 through 6.

<Note>

Even if the [LIMITER] switch of a channel in the group is set to “OFF”, the input level of the channel is checked by the limiter. Therefore, do not feed any audio signal to the unused channel in the group to prevent a malfunction of the limiter.

<Threshold>

Option	Comment
-12dB	The threshold is set to -12 dB. (default)
-6dB	The threshold is set to -6 dB.

<Ratio (compression ratio)>

Option	Comment
1: 3	The ratio is set to 1:3. (default)
1: 5	The ratio is set to 1:5.

Default file name setting (Default file name)

When recording is made in the New File mode, a new file is created and a name is given automatically.

The “Default file name” menu selects the name form of an audio file when it is created between date information base and scene/take number information base.

On “Default file name” menu screen, you can select a desired file name mode, as well as specify the default file name (scene name and the take number).

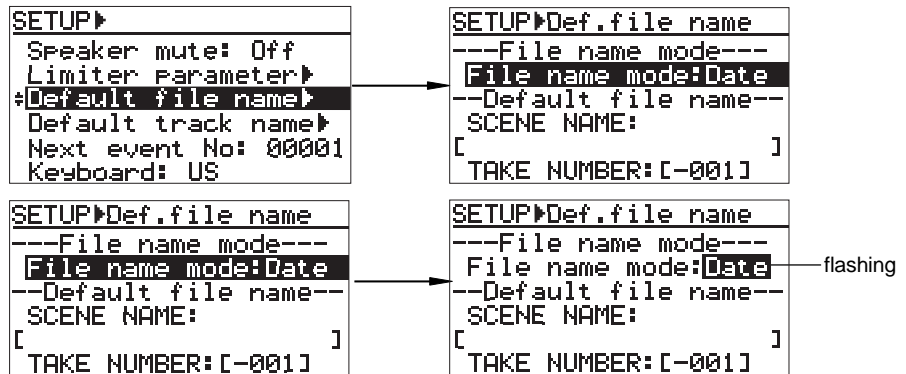

Only when setting the “File name mode” to “Take”, the cursor automatically moves to the “SCENE NAME” field, then to the “TAKE NUMBER” field, allowing you to specify them.

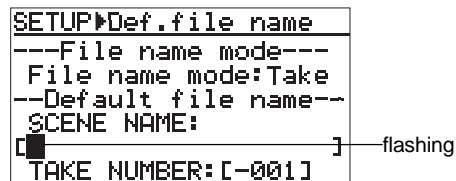

When the “File name mode” is set to “Take”, the name form of an audio file is “<SCENE NAME> + <TAKE NUMBER>”. (The TAKE NUMBER is incremented automatically each time a file is created.)

<File name mode>

Option	Comment
Date	The internal real-time clock data (with “.wav”, the file extension) is the file name. Example: B05h 05m 06s 02jan 2003.wav
Take	“<SCENE NAME> + <TAKE NUMBER>” (with “.wav”, the file extension) is the file name. The TAKE NUMBER is incremented automatically each time a file is created.

<SCENE NAME>

Comment
Up to 17 ASCII characters can be entered. The first character must be alphabetical.

<TAKE NUMBER>

Option	Comment
001-999	The selected TAKE NUMBER follows SCENE NAME. The selected TAKE NUMBER is applied to the first file created.

<Note>

If you enter “000” to the TAKE NUMBER field, it is automatically set as “001”.

For example, if you set “SCENE NAME” to “Action” and “TAKE NUMBER” to “-003”, the file name of an audio file created when recording in the “New File mode” is made for the first time is “Action-003”. After then, each time you make recording in the “New File mode”, the TAKE NUMBER is automatically incremented, so the file name will be “Action-004”, “Action-005”, ...

Default track name setting (Default track name)

The “Default track name” menu specifies the default track name for each track of an audio file created when recording is made in the “New File mode”. The name specified for each track in advance is automatically added to the track number. The default track name is recorded to each file as “fTRK” information in the BWF BEXT Chunk Description. In the “Default track name” menu screen, select a desired track and then enter the desired name. The default track names are initially set to “track 1”, “track 2”, “track 3”, “track 4”, “track 5” and “track 6”.

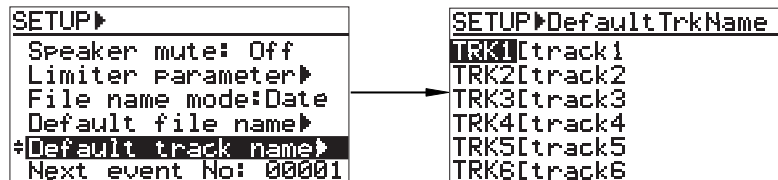

Comment
Up to 16 ASCII characters can be entered as a track name.

<Note>
 To edit a track name of a file, use the “Edit descriptor” item in the “File info.” menu of the Utility mode.

Next event number setting (Next event No.)

The “Next event No.” menu sets the event number in the description information of an audio file. The event number is recorded to each file as “fEVENT” information in the BWF BEXT Chunk Description. With the “Next event No.” menu, you can set the desired number between 00001 and 99999.

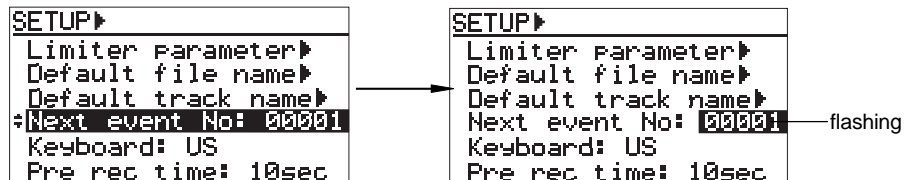

Options	Comment
00001 to 99999	The default is “00001”.

<Notes>

- The edited value is reflected to newly recorded audio files. It does not affect the current audio files.
- If the event number exceeds 99999, the number starts from 00001 again.

USB keyboard type setting (Keyboard)

The “Keyboard” menu selects the type of a USB keyboard connected to the [USB] connector.

By connecting a USB keyboard, you can control some of the PD-6 from the keyboard.

With the “Keyboard” menu, you can select between “US” and “JAPAN”.

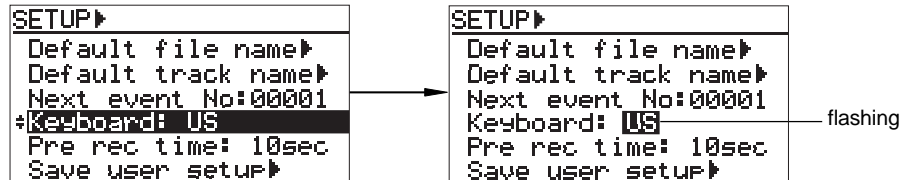

Options	Comment
US	A US keyboard can be connected.
JAPAN	A Japanese keyboard can be connected.

<Note>

See page 55 for details about how to use a USB keyboard for controlling the PD-6.

Pre-record time setting (Pre rec time)

The “Pre rec time” menu sets the pre-record time of audio pooled in the buffer.

When starting recording with the [PRE REC] switch set to “ON”, recording is made from the pre-recorded audio pooled in the buffer. This allows glitch-free recording.

With the “Pre rec time” menu, you can set the pre-record time between 1 and 10 seconds.

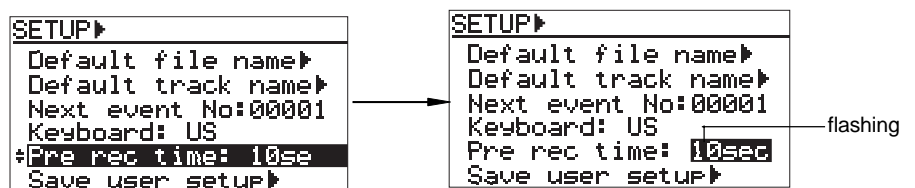

Options	Comment
1 second to 10 seconds	The pre-record time can be set in 1 second steps. (default: 10 seconds)

<Note>

When making recording at 88.2 kHz or 96 kHz Fs with the “Pre rec” switch set to “ON”, the maximum buffered time is limited to five seconds. Therefore, even if you set the “Pre rec time” menu to more than 5 seconds, the recording buffer can hold only 5-second audio data.

Setup data saving (Save user setup)

The “Save user setup” menu is used to save whole Setup data to a user box. You can load the Setup data saved as required.

In the “Save user setup” menu screen, you can select a user box where data is saved, give a name to the box, and save the data.

<Note>
 The settings of the default file name, default track name and event number are not saved.

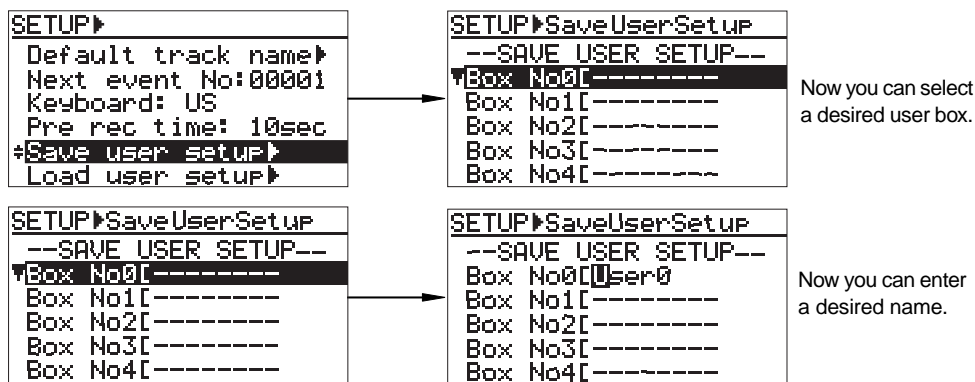

<User box selection>

Comment
You can select a user box from among Box Number 0 through 6.

<Name entry>

Comment
Up to 8 ASCII characters can be entered.

Setup data loading (Load user setup)

The “Load user setup” menu is used to load Setup data saved in a user box.

In the “Save user setup” menu screen, you can select a user box where data is saved and load the data.

If you select “[Default setup]” at the top of the list, the default setup data is loaded.

<Note>
 If you load “[Default setup]”, the settings of the default file name, default track name and event number are initialized. Note that the settings of these items are not changed when other user box data is loaded.

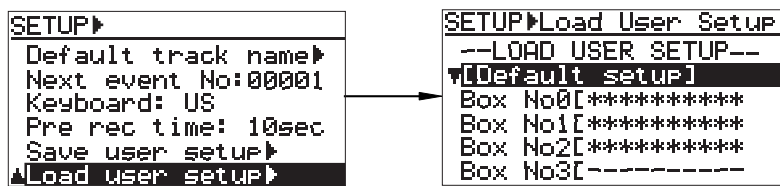

ROM version checking (Version)

In the “Version” menu screen, you can check the software ROM version number and creation/revision date.

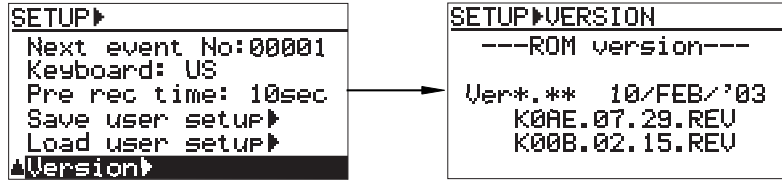

Chapter 8: Utility mode

The Utility mode includes menus for settings and operations regarding disks and files. This chapter describes details about each menu in the Utility mode.

<Table of contents>

Utility menu details	106
How to select a Utility menu	107
Editing a file name [Edit file name]	108
Editing a file information editing [File info.]	109
Checking file information	109
Checking a description information	109
Editing a description information	111
Adding a description information	111
Deleting a description information	111
Deleting an unnecessary audio file [Delete file]	112
Restoring a deleted audio file [Restore Del. file]	113
Optimizing the current disk [Optimize disk]	114
Formatting the current disk [Format]	115
Editing the reel number (volume label) [Reel No.]	118
Selecting the record protection “On” or “Off” [Rec protect]	119
Selecting the resume function “On” or “Off” [Resume]	120
Setting IEEE1394 connection [IEEE1394]	121

Utility menu details

The Utility mode includes execution menus and setting menus regarding disks and files. The menu items may change when the PD-6 software is upgraded.

Execution menu	Function
Edit File name	You can edit a file name of the currently loaded audio file.
File Info.	You can check audio file information (descriptor, file name, file No., creation date, start time, end time, duration and file volume), as well as edit the descriptor information
Delete File	You can delete an unnecessary file. Only the currently loaded audio file can be deleted.
Restore Del File	You can restore the deleted file.
Optimize Disk	You can optimize the current disk.
Format	You can format the current disk (regardless of whether it is formatted or not)

Setting menu	Function	Default setting
Reel No.	You can edit the reel number of the currently loaded audio file.	S001
Rec Protect	You can select "On" or "Off" of the recording protection function for the currently loaded audio file.	Off
Resume	You can select "On" or "Off" of the resume function for the currently loaded audio file.	Off
IEEE1394	You can select "Connect" or "Disconnect" of the IEEE1394 connection.	DISCONNECT

How to select a Utility menu

To select a desired Utility menu and make editing or carry out the operation, use the following keys and dial.

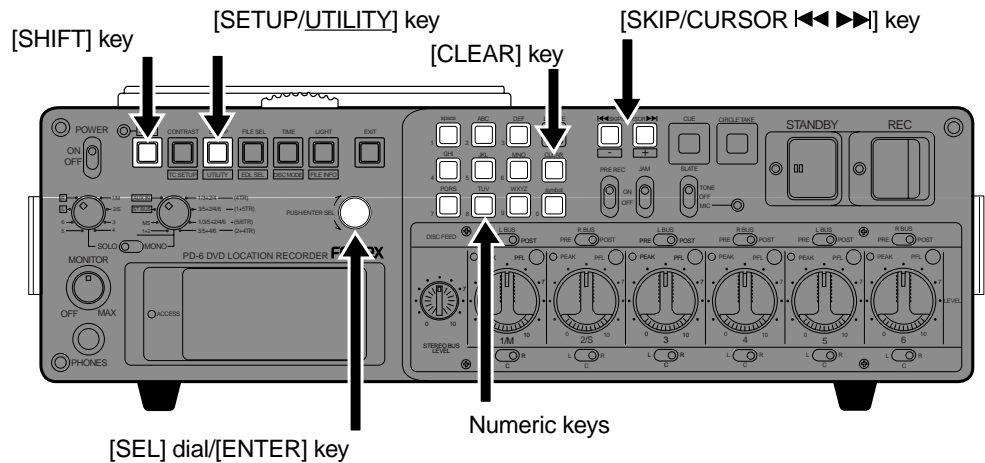

1. **When the [SHIFT] indicator is lit, press the [SETUP/UTILITY] key.**
The PD-6 enters the Utility mode and the display shows the primary UTILITY screen on which you can select a menu.
“▼” tells you that more menus are hidden under the screen currently shown.
Some menu has “▶” on the right. This indicates you can enter the dedicated screen(s) of the menu.



2. **Select the desired Utility menu using the [SEL] dial.**
Under the “Format” menu, the following menus are hidden.



3. **Press the [ENTER] key.**
Now you are ready for making editing or carrying out the operation.
For details about the actual procedure for editing or operation, see the following description.

Editing a file name [Edit file name]

The “Edit File name” menu edits a file name of the currently loaded audio file.

- 1. Select the “Edit file name ▶” menu and press the [ENTER] key.**
The display changes to show the dedicated “File name” screen, on which you can edit the current file name.
The leftmost character flashes.

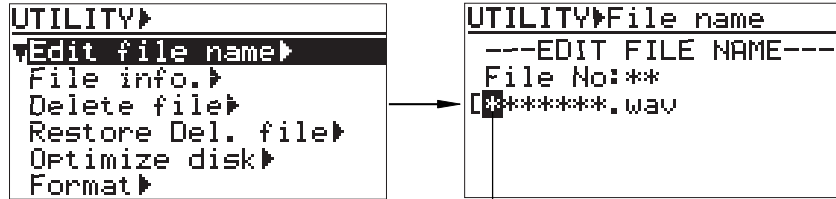

- 2. Enter the desired name.**
Use the [◀ SKIP/CURSOR ▶] keys to move the cursor position and use the [SEL] dial (or the numeric keys) to enter a desired character.
By pressing the [CLEAR] key repeatedly when the cursor is pointing the leftmost character, you can clear the whole name.
- 3. After entering the name, press the [ENTER] key to confirm the setting.**
The Utility mode exits and the display shows the Normal screen.

<Note>
If you are going to set a file name which already exists, “Illegal Name!” is shown and the display returns to show the previous screen.

Editing a file information editing [File info.]

Using the “File info.” menu, you can check audio file information as well as edit the descriptor information.

You can check the following file information.

- File name of the audio file
- Descriptor information (BWF Sound Sequence information)
- File creation date (year/month/day) and time (hour/minute/second)
- Start time information (LTC start time)
- End time information (LTC time at the recording end)
- Duration information (of audio area, shown in time code)
- File volume (occupying space)

Checking file information

1. **Select the “File Info. ▶” menu and press the [ENTER] key.**

The display changes to show the dedicated “File info.” screen, on which you can check the current file information.

“Edit descriptor” has its own screen. The other items are “information only”. By rotating the [SEL] dial, you can see “DUR” (duration information) and “Vol.” (file volume information) under “End”.

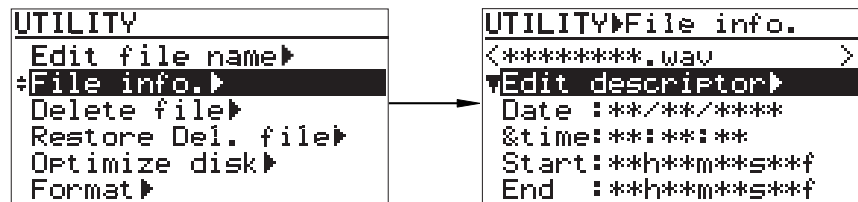

You can check the “Edit descriptor” information by the following procedure.

Checking a description information

“Edit descriptor” is the Edit Sequence Descriptor function.

You can check and edit the recording area (up to 265 characters of the description area specified by the BWF standard) for the sound sequence information of a BWF file.

1. **Select the “Edit descriptor ▶” menu and press the [ENTER] key.**

The display shows the BWF sound sequence information.

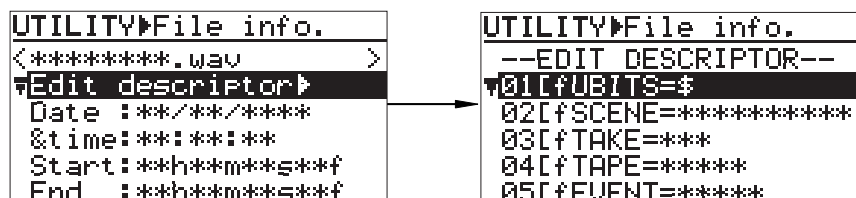

2. **By rotating the [SEL] dial, the sound sequence information is scrolled.**

The information includes the following items.

```

UTILITY>File info.
--EDIT DESCRIPTOR--
01[fUBITS=$
02[fSCENE=*****
03[fTAKE=***
04[fTAPE=*****
05[fEVENT=*****
06[fTRK1=*****
07[fTRK2=*****
08[fNOTE=
09[<New line>
    
```

The table below shows the details for the description information which Fostex registers by default according to the screen example above. These information can be used for creating an ALE file of AVID, as well as can be directly exported to the AVID system via IEEE 1394 (or via a disk).

<Note>
 Each character string before “=” shows the “header ID” of currently available meta data.

Line No.	Display	Details of setting/execution
01	fUBITS=\$	The user bit used when recording time code is recorded as the default setting.
02	fSCENE=*****	When creating a file, the character string before “-” in the file name is set as SCENE by default.
03	fTAKE=***	When creating a file, the three-digit number between “-” and the file extension in the file name is set as TAKE by default.
04	fTAPE=*****	When creating a file, the reel number (volume label) on the disk is set as TAPE (up to 8 digits) by default.
05	fEVENT=*****	The five-digit number set by the “Set Next Event” menu in the Setup mode is set by default.
06	fTRK1=*****	Track name of each track. A default track name (up to 16 characters) is recorded for each. The screen above shows the example when the recording mode is set to stereo (2-track). The number of lines increases if more recording tracks are used.
07	fTRK2=*****	
08	fNOTE=	This is used for comment. By default, no data exists.

Each of these description information items can be edited. “<New line>” (see the screen example above) is reserved for adding a new information. See “Editing a description information” on the next page for details.

Editing a description information

1. **Select a description information item and press the [ENTER] key.**
The leftmost character of the selected item flashes. You can now make editing.

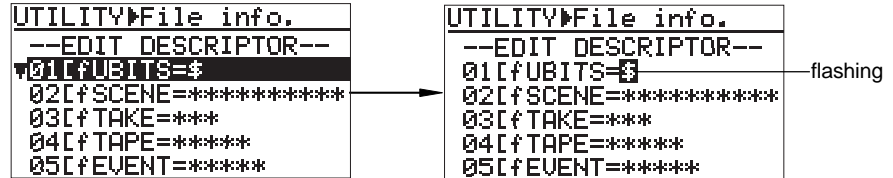

2. **Use the [SKIP/CURSOR >>>] key to move the cursor to any desired character on the right of “=”.**
 3. **Use the [SEL] dial (or numeric keys) to enter the desired character.**
Use the [SKIP/CURSOR >>>] key to move the cursor.
When using the numeric keys for entering characters, pressing any other numeric key moves the cursor to the right automatically.
- To clear the currently recorded information, press the [CLEAR] key. Pressing the [CLEAR] key clears the right next character to the cursor position.
4. **After editing the information, press the [ENTER] key to confirm the setting.**
 5. **To edit other items, carry out the same procedure as above repeatedly.**

Adding a description information

1. **Select the “<New line>” item at the bottom and press the [ENTER] key.**
You are ready to enter information.
Carry out the same procedure as above for entering new information.

<Note>
When adding information to “New line”, enter the “meta data header ID” followed by data.

Deleting a description information

1. **Select a line you want to delete, and press the [ENTER] key.**
You can now edit the information, as described above.
2. **Use the [CLEAR] key to clear the whole information, and press the [ENTER] key.**
The line is deleted, while the following lines move up.

Deleting an unnecessary audio file [Delete file]

Using the “Delete file” menu, You can delete the currently loaded audio file.

1. **Select the “Delete file ►” menu and press the [ENTER] key.**

The “Del. file” screen appears, on which the current file number and file name are shown, while “Sure?” flashes.

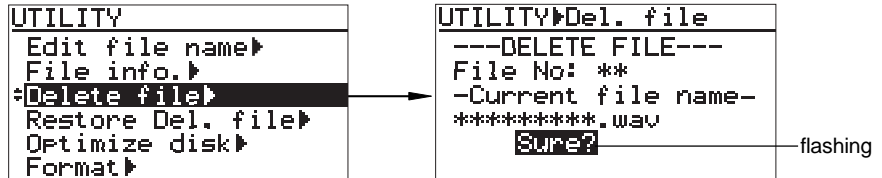

<Note>

To cancel deleting a file, press the [EXIT] key while “Sure?” is flashing. You cannot cancel the operation after starting deleting.

2. **Press the [ENTER] again.**

The PD-6 starts deleting the current audio file.

While processing, “Please wait!” is flashing on the display.

When deleting is completed, “Completed!” appears on the display and the Utility mode exits.

<Note>

A deleted file is not completely deleted from the disk. It still exist as a “hidden file”. You can restore a hidden file by the “Restore Del File” menu described below. However, if you optimize the disk after deleting a file, the file cannot be restored anymore.

A file completely deleted from a disk is shown as “<<Deleted File>>”.

<Note>

After deleting audio files on a disk formatted in the “Tape” mode, if you optimize the disk, it changes to a Normal mode disk.

Restoring a deleted audio file [Restore Del. file]

Using the “Restore Del. file” menu, you can restore a hidden file which is deleted by the “Delete file” menu.

<Note>

*if you optimize the disk after deleting files, the file cannot be restored anymore because the “hidden files” are completely deleted.
Also note that a file deleted on a computer cannot be restored.*

1. Select the “Restore Del. file ▶” menu and press the [ENTER] key.

The deleted files are listed on the “R.S file” screen.

If no deleted (hidden) file exists, “No deleted file!” is shown.

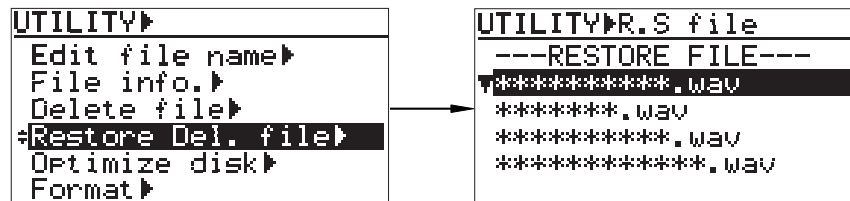

2. Select a file you want to restore using the [SEL] dial, and press the [ENTER] key.

The file is restored.

After “Completed!” is shown, the Utility mode exits.

<Note>

The restored file returns to the original position (file number) when it was deleted.

Optimizing the current disk [Optimize disk]

Using the “Optimize disk” menu, You can optimize a DVD-RAM disk. By optimizing a used disk, deleted (hidden) audio files are completely deleted, and the disk free space increases.

<Note>
if you optimize the disk after deleting files, the file cannot be restored anymore because the “hidden files” are completely deleted.

1. **Select the “Optimize disk ▶” menu and press the [ENTER] key.**
The “CAUTION” message appears in which “Are you sure?” flashes. To cancel optimizing the disk, press the [EXIT] key.

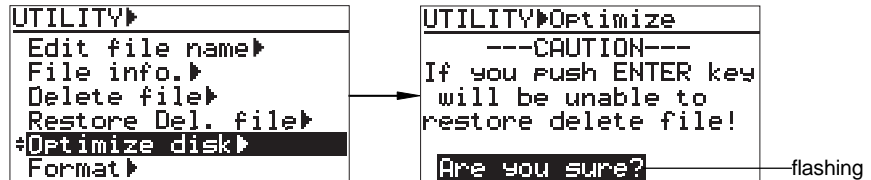

2. **Press the [ENTER] again.**
The display changes to show the following screen. The disk remaining space is shown in “MB” as well as in “%” on the bar-graph meter. After completing optimizing, “Completed!” is shown.

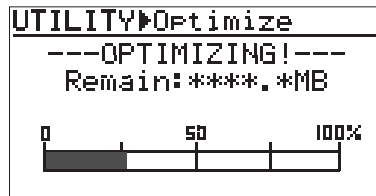

3. **Press the [EXIT] key to exit the Utility mode.**

Formatting the current disk [Format]

Using the “Format” menu, you can format the current disk
 In the following description, we assume to reformat a used DVD-RAM disk in the “Normal” or “Tape” mode.

See “Chapter 2: Before using the PD-6” on page 24 for details about initially formatting an unused disk.

<Notes>

On a disk formatted in the “Tape” mode, an audio file whose record track mode and Fs match the [REC TR] and [FS/24] select switch settings when formatting is taken place, is created. Therefore, before formatting a disk in the “Tape” mode, make sure to set the [REC TR] and [FS/24] select switches on the top panel appropriately. Also note that you cannot carry out “Tape” mode formatting in the following [FS/24] and [REC TR] switch conditions.

- When the [REC TR] switch is set to “2+4” or “1+5” file mode, regardless of the [FS/24] switch setting.
- When the [REC TR] switch is set to “4”, “5” or “6”, while the [FS/24] switch is set to “88.2” or “96”.

If you are going to carry out “Tape” mode formatting in any condition above, “Illegal FS!”, “Illegal FS or TR!”, or “Illegal REC TR!” is shown and the operation is ignored.

1. **Select the “Format ▶” menu and press the “ENTER” key.**

The “Format” screen is shown.

In this screen, you can make setting for items regarding formatting. (By default, “Drive: INT DVD-RAM” is highlighted.)

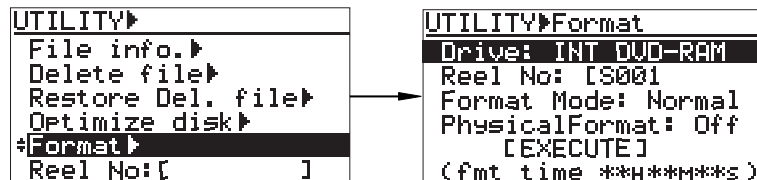

2. **Use the [SEL] dial to select “Reel No: ****”, and press the [ENTER] key.**

Now you can edit the reel number (by default, “S” of “S001” flashes).

You do not have to change the reel number.

The reel number also can be edited using the “Reel No.” menu in the Utility mode. The box below explains how to enter the desired reel number during format operation.

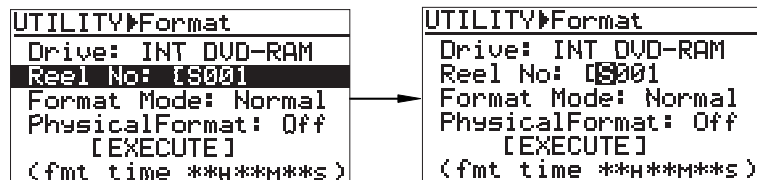

How to enter a reel number (volume label)

Use the [SEL] dial (or the numeric keys) to enter a desired character.

Use the [◀ SKIP/CURSOR ▶] keys to move the cursor position.

Pressing the [CLEAR] key clears the right next character to the cursor position.

3. After editing the reel number (or leaving the reel number as the default setting), press the [ENTER] key.

The reel number is set, while the current “Format mode” option (“Normal”, by default) starts flashing automatically.

Now you can select the format mode between “Normal” and “Tape”.

```

UTILITY▶Format
Drive: INT DVD-RAM
Reel No: [S001
Format Mode: Normal
PhysicalFormat: Off
[EXECUTE]
(fmt time **H**M**s)
    
```

Normal	Tape
With a disk formatted in the “Normal” mode, you can make recording in the “New file mode” anytime. Up to 199 audio files can be created on a disk.	A disk formatted in the “Tape” mode can be regarded as if it were a single prerecorded audio file. You can record to the disk in the Insert mode.

4. Select the format mode, and press the [ENTER] key.

Depending on the format selected, the display shows either of the following screens.

When selecting “Normal”, you are going to do next is to select “On” or “Off” of the physical format.

When selecting “Tape”, you are going to do next is to select the disk type between “New” and “Used”.

In both of these screens, the approximate time required for formatting is shown at the bottom.

When selecting “Normal”

```

UTILITY▶Format
Drive: INT DVD-RAM
Reel No: [S001
Format Mode: Normal
PhysicalFormat: Off
[EXECUTE]
(fmt time **H**M**s)
    
```

When selecting “Tape”

```

UTILITY▶Format
Drive: INT DVD-RAM
Reel No: [S001
Format Mode: Tape
Disk type: New
[EXECUTE]
(fmt time **H**M**s)
    
```

On	Select this option when you format a troublesome disk which has been used many times and has caused troubles, such as sound jumping or slow access speed. When selecting this option, it takes longer to format the disk.
Off	Select this option when you format a relatively new disk. When selecting this option, it takes shorter to format the disk.

New	A disk is quick-formatted instead of being completely initialized. A disk formatted in the “Tape” mode last time is formatted while the currently recorded audio data remains.
Used	The whole disk is physically formatted. All the currently recorded audio data is erased. When selecting this option, it takes longer to format the disk.

<Note>

It may rarely happen that, when you set a disk which has not been physically formatted before, the PD-6 automatically selects "On" (for "Normal" mode) or "Used" (for "Tape" mode) and executes physical formatting.

5. **After selecting the option in the above step, press the [ENTER] key.**
"EXECUTE" is highlighted on the screen.

6. **Press the [ENTER] key.**

The "CAUTION" message screen on which "Are you sure" flashing appears on the display.

To cancel formatting, press the [EXIT] key while this message screen is shown (or in the previous steps).

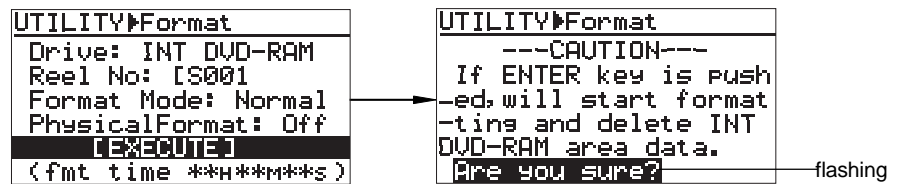

7. **Press the [ENTER] key.**

Formatting starts.

The display changes to show the following screen.

The progress status is shown by remaining time, as well as in "%" on the bargraph meter.

After completing formatting, "Completed!" is shown.

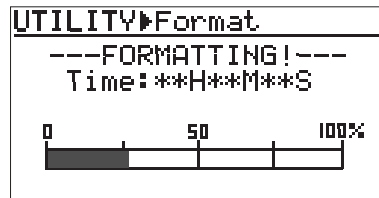

<Note>

If you enter an illegal reel number (volume name) and are going to carry out formatting, the display shows "Illegal name!" and returns to the screen on which the reel number can be edited.

<Notes>

Depending on the disk condition, it may rarely happen that physical formatting is not normally completed. In such a case, "Disk Error!" is shown and the disk lock is released. You need to replace the disk.

It may also be possible that a disk rejected by a PD-6 is accepted by another PD-6, because the criterion of rejecting disks may not be exactly the same between PD-6s.

8. **Press the [EXIT] key to exit the Utility mode.**

See the explanation below about the screens shown after completing formatting by the "Normal" or "Tape" mode.

If you format a disk in the “Normal” mode, “—No Files!—” appears, showing that no audio file exists on the disk.

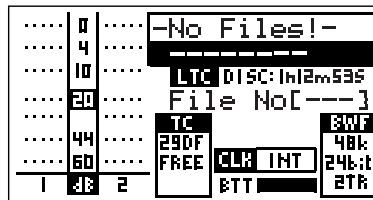

If you format a disk in the “Tape” mode, an audio file named “Tape_mode1.wav” is created and the screen as below is shown. The track mode and Fs are fixed according to the settings of the [FS/24] and [REC TR] switches when formatted. If you want to change these settings, you have to reformat the disk after setting the [FS/24] and [REC TR] switches appropriately. With a “Tape” mode file, “TAP” is shown below the file number on the display (as shown in the screen example below).

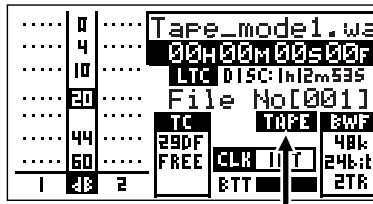

Editing the reel number (volume label) [Reel No.]

Using the “Reel No.” menu, you can edit the reel number of the currently loaded audio file. The reel number is also used as the disk volume label, and reel number editing always reflects to the disk volume label.

1. **Select the “Reel No: [****]” menu and press the [ENTER] key.**
The leftmost character of the current reel number flashes and you can now edit the reel number (by default, “S” of “S001” flashes).

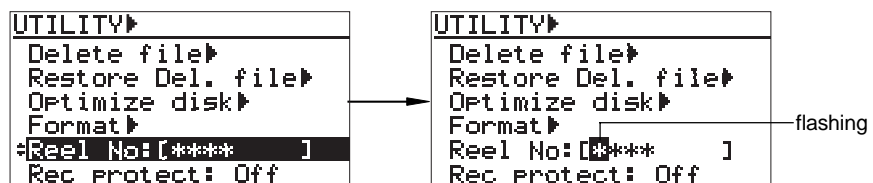

2. **Use the [SEL] dial (or the numeric keys) to enter a desired reel number.**
Use the [◀ SKIP/CURSOR ▶] keys to move the cursor position. When using the numeric keys for entering characters, pressing any other numeric key moves the cursor to the right automatically. Pressing the [CLEAR] key clears the right next character to the cursor position.
3. **After editing the reel number, press the [ENTER] key.**
4. **Press the [EXIT] key to exit the Utility mode.**

Selecting the record protection on or off [Rec protect]

Using the “Rec protect” menu, you can select “On” or “Off” of the recording protection (record prohibit) for the currently loaded audio file.

1. Select the “Rec protect: ****” menu and press the [ENTER] key.
The current option (“On” or “Off”) flashes (the default is “Off”).

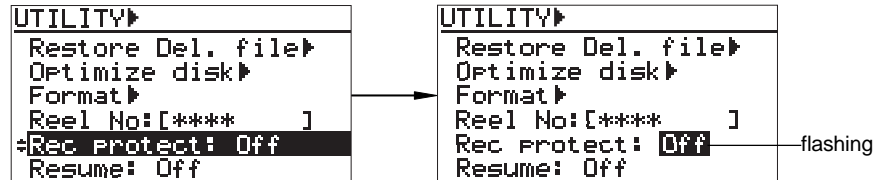

<Note>

If you enter the Utility mode when no file is available on the current disk, “Rec protec—” is shown instead of “Rec protect: Off (or On)”. This means there is no audio file to which the “Rec protection” setting is applied. If you select it and press the [ENTER] key in this case, “Void!” is shown.

2. Use the [SEL] dial to select “On” or “Off”, and press the [ENTER] key to confirm the setting.
3. Press the [EXIT] key to exit the Utility mode.

<Note>

On the Normal screen, a record protected audio file has the “key” icon beside the file name, as show below.

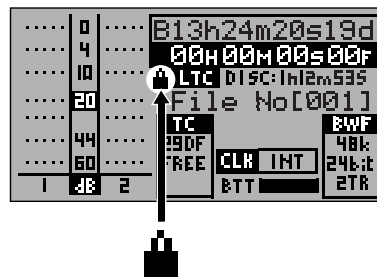

Selecting the resume function on or off [Resume]

Using the “Resume” menu, you can select “On” or “Off” of the resume function for the currently loaded audio file.

By setting this menu to “On”, the current file information including the current playback position is stored in the resume file when the disk is ejected, and the next time the file is loaded, the recorder automatically locates the stored playback position.

1. **Select the “Resume: ****” menu and press the [ENTER] key.**
The current option (“On” or “Off”) flashes (the default is “Off”).

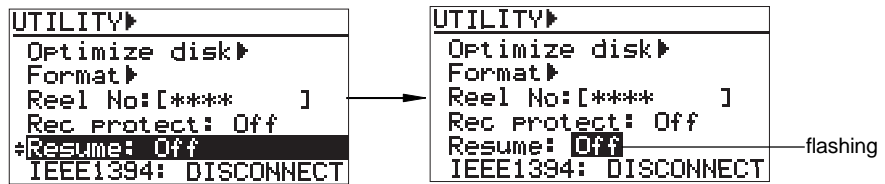

2. **Use the [SEL] dial to select “On” or “Off”, and press the [ENTER] key to confirm the setting.**
3. **Press the [EXIT] key to exit the Utility mode.**

Setting IEEE1394 connection [IEEE1394]

Using the “IEEE1394” menu, you can select “CONNECT” or “DISCONNECT” of the IEEE1394 connection.

By selecting “CONNECT”, the [IEEE1394] connector can be used to connect the PD-6 to a personal computer, and you can control the PD-6 drive from the computer.

<Note>

When “CONNECT” is selected, the PD-6 drive cannot be controlled from the panel keys.

1. Select the “IEEE1394: ****” menu and press the [ENTER] key.

The current option (“CONNECT” or “DISCONNECT”) flashes (the default is “DISCONNECT”).

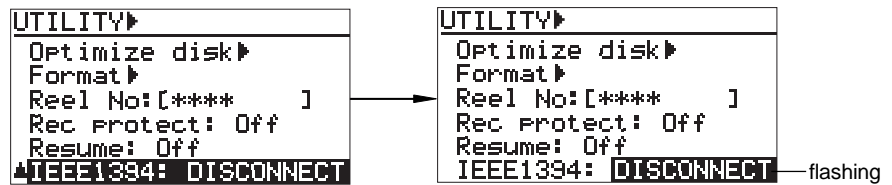

2. Use the [SEL] dial to select “DISCONNECT” or “CONNECT”, and press the [ENTER] key to confirm the setting.

3. Press the [EXIT] key to exit the Utility mode.

If you exit the Utility mode after setting this menu to “CONNECT”, “Selected!—IEEE1394—” is shown on the display.



<Note>

To disconnect the IEEE1394 connection, go to the “IEEE1394” menu again and select “DISCONNECT”.

Chapter 9: EDL SEL mode <Creating and editing an ALE file>

This chapter describes details about the EDL SEL mode.

In this mode, you can create or edit the ALE (Avid Log Exchange) file list on a disk. This file list is used to export data to the AVID system.

<Table of contents>	
Creating a new ALE file	124
Adding audio files to an ALE file	127
Viewing and editing audio file entries	129
Viewing audio file entries	129
Adding an audio file entry to an existing ALE file	130
Deleting an audio file entry	130
Editing an ALE file	131
Editing an ALE file name	131
Remaking an ALE file	132
Deleting an ALE file	133

On a DVD-RAM disk, the “info” folder is created under the “bwff” folder. The “Info” folder contains ALE (Avid Log Exchange) files and various information files such as a diagnoses file.

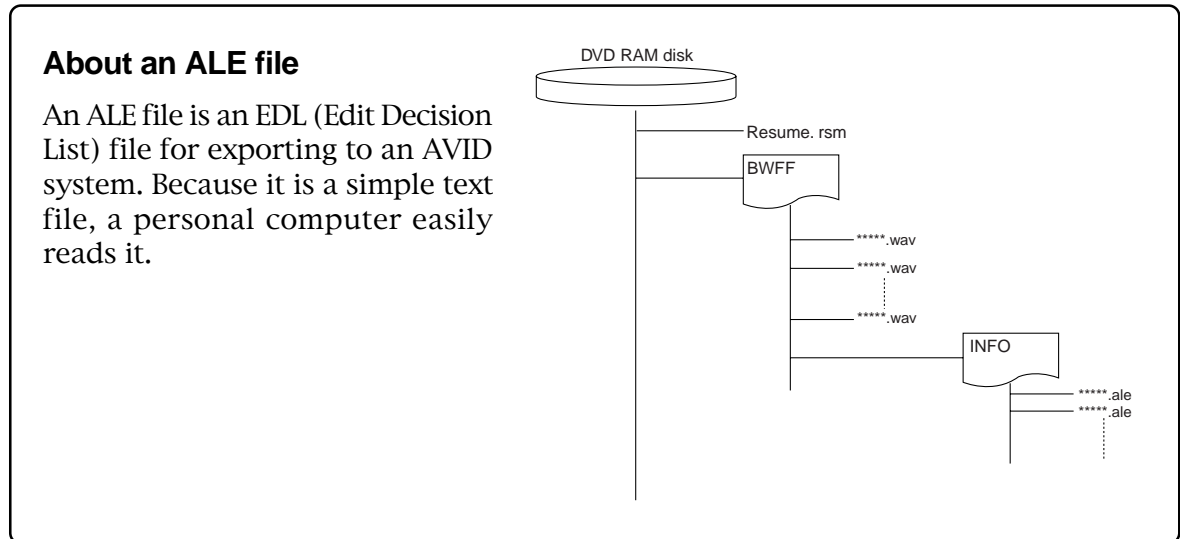

Creating a new ALE file

You can create a new ALE file on the current disk. In the procedure described below, we assume that more than one audio file (BWF) is created on a DVD-RAM disk.

1. **When the [SHIFT] indicator is lit, press the [FILE SEL/EDL SEL] key.**
The display changes to show the ALE screen.

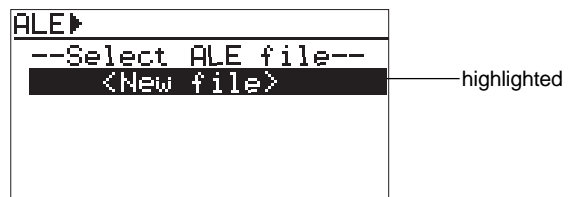

<Note>
 If no ALE file exists on a disk, only “<New file>” is shown as the screen example above. If any ALE file exists on a disk, it is shown.

2. **While “<New file>” is flashing, press the [ENTER] key.**
The display changes to show the screen for entering a name of an ALE file you are going to create.



- Use the [SEL] dial (or the numeric keys) to enter the desired name.
In the screen example below, "ALL-TAKE" is entered as a file list name.

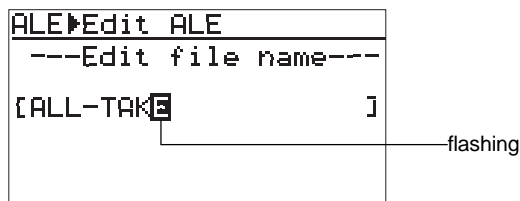

- After entering the desired name, press the [ENTER] key to confirm the setting.
The entered name is stored, while the display changes to show the screen for editing the ALE file, on which the "Video format" menu is highlighted as shown below.

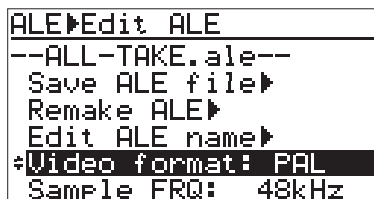

You can select the edit menu by rotating the [SEL] dial. Typically, when you create a new ALE file, you make settings of menus in the following order.

"Video format" -> "Sample FREQ" -> "TAPE" -> "TC frame" -> "Drop frame"

Menu	Function
Delete ALE file	Deletes an ALE file.
Save ALE file	Saves an ALE file.
Remake ALE	Remakes an ALE file.
Edit ALE name	Edits the name of an ALE file.
Video format	Sets the video format of an ALE file.
Sample FRQ	Sets the sampling frequency of an ALE file.
TAPE	Sets the reel number (TAPE) of an ALE file.
TC frame	Sets the TC Frame Rate of an ALE file.
Drop frame	Selects "On" or "Off" of the TC drop frame. You need to select this option appropriately when you select "29.97" for the TC frame.
Entry files	Adds/deletes an audio file to/from the ALE file.

<Note>
When creating a new ALE file, the screen is ready for entering "Edit ALE name". When editing a current ALE file, the "Remark ALE" menu is highlighted on the screen.

- While “Video format” is highlighted, press the [ENTER] key.**
 The display changes to show the screen on which you can select the video format. The current option flashes (default: PAL).

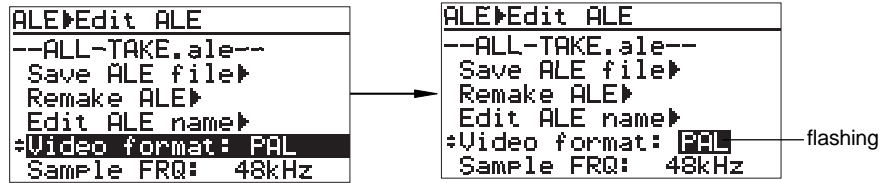

- Use the [SEL] dial to select the video format, and press the [ENTER] key to confirm the setting.**

You can select the video format from among “PAL”, “NTSC” and “SECAM”.

In the same manner as above, set the following menus.

“Sample FRQ” -> “TAPE” -> “TC frame” -> “Drop frame”

The following table shows the options for each menu setting.

Menu	Options
Sample FRQ	44kHz, 48kHz, 88kHz, 96kHz, 176kHz and 192kHz
TAPE	Up to 5 desired characters for a reel number (TAPE)
TC frame	23.97, 30, 24, 29.97 and 25
Drop frame	On and Off (default)

The default setting for each menu except the “Drop frame” menu reflects the setting of the audio file loaded before bringing up the ALE screen.

<Notes>

- If you set the “TC frame” menu to “29.97”, set the “Drop frame” menu to “On”.
- You can use the [SEL] dial (or the numeric keys) to enter “TAPE” (reel number). Use the [SKIP/CURSOR] key to move the cursor. When using the numeric keys for entering characters, pressing any other numeric key moves the cursor to the right automatically.

- After making necessary settings, press the [EXIT] key.**

The display change to show the screen which asks you whether making a new ALE file or not and “Are you sure?” flashes.

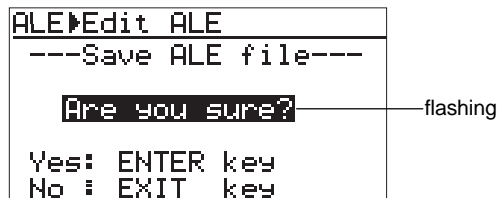

<Note>

To cancel creating a file list, press the [EXIT] key at this stage.

8. Press the [ENTER] key.

A new ALE file is created and added to the ALE file list.

The file extension “.ale” is automatically added when an ALE file is created.

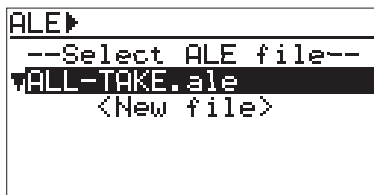

To create another new ALE file, select “<New file>” and follow the same procedure as above.

If you want to finish editing, press the [EXIT] key to dismiss the “Edit ALE” screen. In the following description, we assume to continue editing operation and add audio file entries.

Adding audio files to an ALE file

You can add audio files to an ALE file.

In the following description, we assume to add desired audio files to the ALE file named “ALL-TAKE.ale”, created by the procedure described above.

<Notes>

- If more than one audio file entry in the ALE file overlaps playback range, the audio file entry you added earlier takes priority. The audio file entry you added later cannot be played back in the list play mode of the Fostex DV40.
- Only audio files whose sampling frequency match that of the ALE file can be added.
- When playing back audio file entries in the DV40 list play mode, the condition follows the DV40 switch settings for the list play function.

1. While “ALL-TAKE.ale” is highlighted, press the [ENTER] key.

The display changes to show the screen for editing the ALE file, on which “Remake ALE” is highlighted.

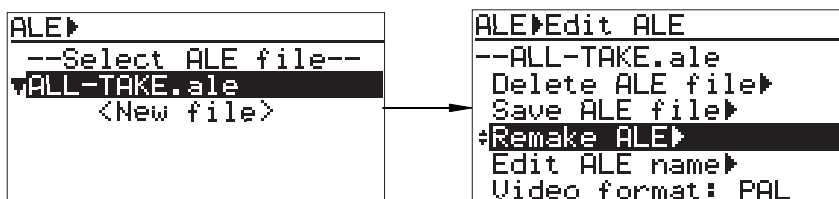

2. Select the “Entry files ▶” menu at bottom of the menu list, and press the [ENTER] key.

The display changes to show the screen for audio file entry, on which “<New entry>” is highlighted.

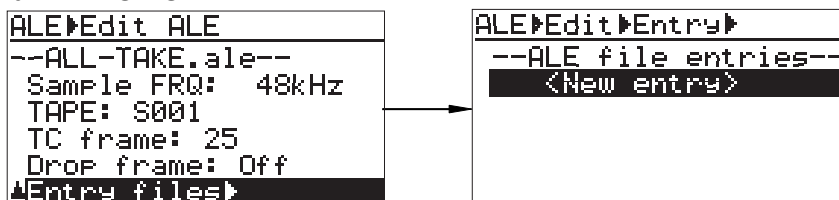

3. **While “<New entry>” is highlighted, press the [ENTER] key.**
 After showing “Please wait!”, the display changes to shows the “Sel. new entries” screen for selecting audio files.

You can select “<Entry all>” if you want to add all audio files on the current disk which can be added to the ALE file, or select an individual file.

```
ALE▶Edit▶Entry▶New▶
--Sel. new entries--
▶ <Entry all>
001 *****.wav
002 *****.wav
003 *****.wav
004 *****.wav
```

<Note>
 To distinguish audio file you want to add to an ALE file, we recommended you to put “@” at the head of each audio file in advance using the [CIRCLE TAKE] key.

4. **Select “<Entry all>” or any desired audio file, and press the [ENTER] key.**
 If you select “<Entry all>” and press the [ENTER] key, all audio file entries are shown on the screen (you can scroll through the list by rotating the [SEL] dial).

```
ALE▶Edit▶Entry▶
--ALE file entries--
▶001 *****.wav
002 *****.wav
003 *****.wav
004 *****.wav
005 *****.wav
```

If you select an individual audio file and press the [ENTER] key, “Sel. next entry!” is shown and you can make another entry successively. Note that the audio files added to the ALE file are omitted from the “Sel. new entries” list. After adding all desired entries, pressing the [EXIT] key brings up the screen as shown below, on which you can check the entries. In the screen example below, audio file “001” has been added.

```
ALE▶Edit▶Entry▶
--ALE file entries--
▶001 *****.wav
<New entry>
```

5. **After adding audio file entries, press the [EXIT] key.**
 The display returns to the “Edit ALE” screen.
6. **Press the [EXIT] key again (or use the [SEL] dial to select “Save ALE file” and press the [ENTER] key).**
 The display shows the screen for saving the ALE file, on which “Are you sure?” flashes.
7. **Press the [ENTER] key.**
 The display shows the screen for selecting an ALE file.
8. **Press the [EXIT] key to exit the “EDL SEL” mode.**

Viewing and editing audio file entries

You can view audio file entries in an ALE file, as well as add (or delete) an audio file entry to (or from) the ALE file.

Viewing audio file entries

Audio file entries in an ALE file can be viewed by the following procedure. We assume that you have made the “ALL-TAKE.ale” file, as in the procedure described above, and you want to see the audio file entries of this ALE file.

1. **When the [SHIFT] indicator is lit, press the [FILE SEL/EDL SEL] key.**
The display changes to show the ALE screen.
You can see “ALL-TAKE.ale” and “<New file>” in the “Select ALE file” list.

```
ALE▶
--Select ALE file--
▼ALL-TAKE.ale
  <New file>
```

2. **While “ALL-TAKE.ale” is highlighted, press the [ENTER] key.**
After showing “Please wait!”, the display changes to show the editing screen (on which “Remake ALE” is highlighted).

<pre>ALE▶ --Select ALE file-- ▼ALL-TAKE.ale <New file></pre>	→	<pre>ALE▶Edit ALE --ALL-TAKE.ale Delete ALE file▶ Save ALE file▶ #Remake ALE▶ Edit ALE name▶ Video format: PAL</pre>
--	---	--

3. **Select “Entry files ▶” using the [SEL] dial, and press the [ENTER] key.**
The screen now shows the entry list in which you can view audio file entries.
The bottom line of the list shows “<New entry>”. This is used to add a new entry (see the next page).

<pre>ALE▶Edit ALE --ALL-TAKE.ale-- Sample FRQ: 48kHz TAPE: S001 TC frame: 25 Drop frame: Off ▲Entry files▶</pre>	→	<pre>ALE▶Edit▶Entry▶ --ALE file entries-- ▼001 *****.wav 002 *****.wav 003 *****.wav 004 *****.wav 005 *****.wav</pre>
--	---	--

4. **Press the [EXIT] key repeatedly until exiting the EDL SEL mode.**

Adding an audio file entry to an existing ALE file

You can add an audio file entry to an existing ALE file.

- 1. On the “ALE file entries” screen shown in step 3 of “Viewing audio file entries” in the previous page, select “<New entry>” and press the [ENTER] key.**
The display changes to show the “Sel. new entries” screen, on which the available audio files and “<Entry all>” are listed.
- 2. Select “<Entry all>” or any desired individual file, and press the [ENTER] key.**
The selected audio file is added to the ALE file (if you select “<Entry all>”, all available files are added).
- 3. After adding audio file entries, press the [EXIT] key.**
The display returns to the “Edit ALE” screen.
- 4. Press the [EXIT] key twice.**
The display shows the screen for saving the ALE file, on which “Are you sure?” flashes.
- 5. Press the [ENTER] key to save the ALE file.**
- 6. Press the [EXIT] key to exit the “EDL SEL” mode.**

Deleting an audio file entry

You can delete an unnecessary audio file entry from the ALE file.

- 1. On the “ALE file entries” screen shown in step 3 of “Viewing audio file entries” in the previous page, select the file entry you want to delete and press the [CLEAR] key.**
After showing “Deleted!”, the selected file entry is deleted immediately.

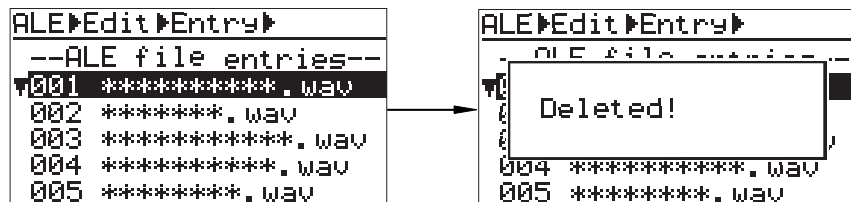

- 2. Press the [EXIT] key twice.**
The display shows the screen for saving the edited ALE file, on which “Are you sure?” flashes.
- 3. Press the [ENTER] key to save the ALE file.**

Editing an ALE file

You can edit an existing ALE file.

Editing an ALE file name

You can edit an ALE file name shown in the ALE file list. The following example shows how to edit the “ALL-TAKE.ale” ALE file created in the operation example described earlier.

1. **When the [SHIFT] indicator is lit, press the [FILE SEL/EDL SEL] key.**
The display changes to show the ALE screen.
You can see the created ALE file(s) and “<New file>” in the “Select ALE file” list.

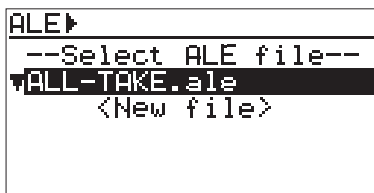

2. **Select (highlight) an ALE file you want to delete, and press the [ENTER] key.**
The display changes to show the “Edit ALE” screen on which you can select an editing menu.
3. **Select “Edit ALE name ▶” using the [SEL] dial, and press the [ENTER] key.**
The display now shows the “Edit file name” screen on which the leftmost character of the current ALE file name is flashing.

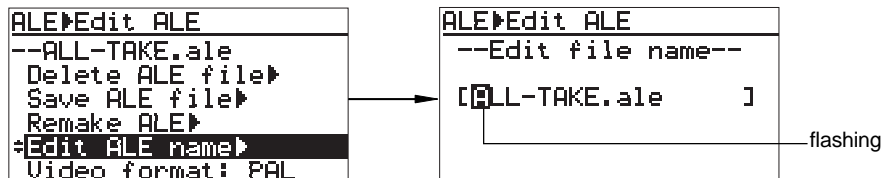

Use the [◀◀ SKIP/CURSOR ▶▶] keys to move the cursor position and use the [SEL] dial (or the numeric keys) to enter a desired character. By pressing the [CLEAR] key repeatedly when the cursor is pointing the leftmost character, you can clear the whole name. The file extension is automatically added to the name.

4. **After completing editing the name, press the [ENTER] key.**
The new name is confirmed and the display returns to the “Edit ALE” screen on which you can select an editing menu.
5. **Press the [EXIT] key repeatedly until you exit the EDL SEL mode.**

Remaking an ALE file

If you edit an audio file which is used in the ALE file and the start time, end time, or the description information is changed, the ALE file must be remade. You can also remake the ALE file by selecting only audio files whose “Circle take” is set to “On”.

The following procedure example describes how to remake the “ALL-TAKE.ale” file.

1. **When the [SHIFT] indicator is lit, press the [FILE SEL/EDL SEL] key.**
The display changes to show the ALE screen.
You can see the created ALE file(s) and “<New file>” in the “Select ALE file” list.
2. **Select (highlight) “ALL-TAKE.ale”, and press the [ENTER] key.**
The display changes to show the “Edit ALE” screen on which you can select an editing menu and “Remake ALE” is initially highlighted.
3. **While “Remake ALE ▶” is highlighted, press the [ENTER] key.**
The display now shows the “Remake ALE” screen.
You can select the “Type” option between “Renewal” and “Circle Take”.

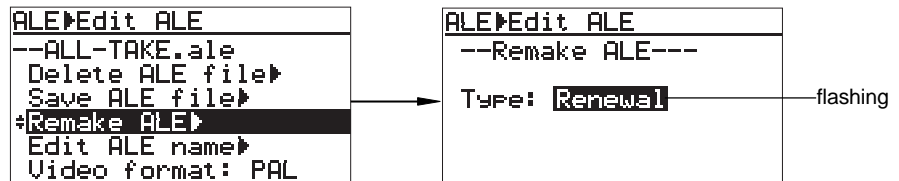

Renewal	Circle Take
The audio file entry list in the ALE file is not changed. The ALE file is updated by remaking only the edited items in audio files.	A new ALE file, containing only audio file entries with “Circle take” set to “On”, is created. The old (previous) ALE file is deleted.

4. **Select the desired type and press the [ENTER] key.**
If you select “Renewal”, the PD-6 immediately remakes the ALE file, and the display returns to the “Edit ALE” screen on which you can select an editing menu.

If you select “Circle Take”, “Sure?” flashes on the screen. Press the [ENTER] key again. The PD-6 remakes the ALE file, and the display returns to the “Edit ALE” screen on which you can select an editing menu.
5. **Press the [EXIT] key.**
The display shows the screen for updating the remade ALE file, and “Are you sure?” flashes.
6. **Press the [ENTER] key to update the ALE file. If you do not update the file, press the [EXIT] key.**
7. **Press the [EXIT] key repeatedly until you exit the EDL SEL mode.**

Deleting an ALE file

You can delete an audio file entry in the ALE file.
 The following procedure example describes how to delete the “ALL-TAKE.ale” file entry.

1. **When the [SHIFT] indicator is lit, press the [FILE SEL/EDL SEL] key.**
 The display changes to show the ALE screen.
 You can see the created ALE file(s) and “<New file>” in the “Select ALE file” list.
2. **Select (highlight) “ALL-TAKE.ale”, and press the [ENTER] key.**
 The display changes to show the “Edit ALE” screen on which you can select an editing menu and “Remake ALE” is initially highlighted.
3. **Use the [SEL] key to select (highlight) “Delete file ALE ▶”, and press the [ENTER] key.**
 The display now shows the “Delete file” screen, on which “Are you sure?” flashes.

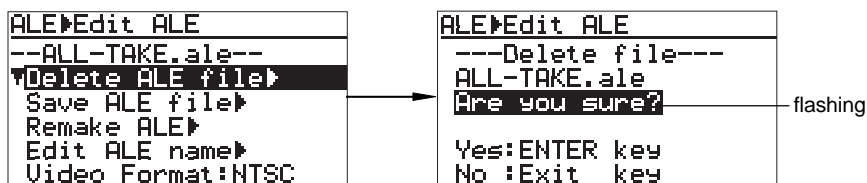

4. **Press the [ENTER] key to delete the file entry. If you do not delete the file entry, press the [EXIT] key.**
 The audio file entry is deleted and the display returns to the “Select ALE file” screen.
5. **Press the [EXIT] key repeatedly until you exit the EDL SEL mode.**

Chapter 10: Exporting files using IEEE1394

This chapter describes how to transfer audio files between the PD-6 and a personal computer using IEEE1394.

<Table of contents>

Connection between the PD-6 and a PC	137
How to disconnect the PD-6	137
Example of copying data to an external hard disk	138
Example of exporting data to a computer application	138

By connecting the PD-6 to a personal computer via the [IEEE1394] connector, audio file data can be transferred. PD-6 audio data can be copied to a hard disk on the personal computer, or exported to an application software such as Digidesign Pro Tools.

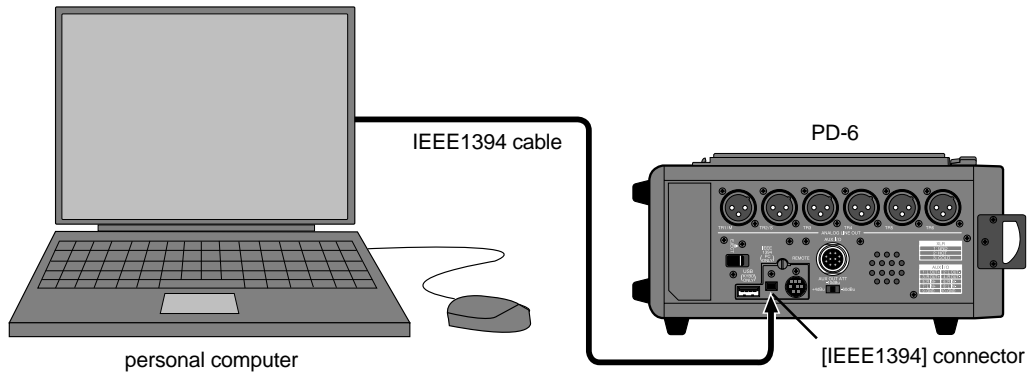

< CAUTION >

The following OS can properly recognize the PD-6 DVD-RAM drive / disk connected to an IEEE1394 port on PC without installing an exclusive driver software or writing software but depending on the OS, read / write function is limited.

< Macintosh >

Mac OS 9.2.2

: Read / Write is possible.

Mac OS X

: Read is only possible. Write is prohibited.

< Windows >

Windows 98SE, ME

: Read is only possible.

When Windows 98SE, ME, 2000 or XP is used, by installing the writing software "Instant Write" from Pinnacle Systems Inc. (ex VOB), Read / Write becomes possible. Please remember that recognition of PD-6 DVD-RAM drive may differ depending on the PC environment. "Instant Write" is included in the package software "Instant CD/DVD" from Pinnacle Systems, Inc.). ("InstantWire" and "Instant CD/DVD" is a registered trademark of a Pinnacle Systems, Inc.)

Connection between the PD-6 and a PC

Use either method (1 or 2) below for connecting the PD-6 to a PC. It is assumed that the PC has already started up in the following description.

<Note>

In the following procedure, we assume that a recorded DVD-RAM disk is set to the PD-6 and an audio file is loaded. If no disk is set or the door is not locked, you cannot make the "IEEE1394" menu setting in the Utility mode.

- 1) **Set the "IEEE1394" menu in the Utility mode to "CONNECT", and turn off the PD-6 power (the menu setting is memorized even if the PD-6 is turned off). Then, connect between the PD-6 and the PC using an IEEE1394 cable, and turn on the PD-6 power.**
- 2) **While the PD-6 power is off, connect between the PD-6 and the PC using an IEEE1394 cable, and then turn on the PD-6 power while holding down the [SHIFT] key (the "IEEE1394" menu is automatically set to "CONNECT").**

How to disconnect the PD-6

To disconnect the PD-6 from the PC, make the PC ready for disconnecting the PD-6, and disconnect the IEEE1394 cable, then set the "IEEE1394" menu to "DISCONNECT".

The procedure for making the PC ready for disconnecting the PD-6 differs depending on the PC. Please refer to the instructions of the PC.

If you turn off the PD-6 power with the "IEEE1394" menu set to "CONNECT" and then turn it on next time, the PD-6 starts up with the "CONNECT" setting. Therefore, by repeating the procedure below, you can easily connect more than one disk to the PC.

- 1) **Turn off the PD-6 power with the "IEEE1394" menu set to "CONNECT".**
- 2) **Change a disk and turn on the PD-6 power again.**
- 3) **After "Selected --IEEE1394--" is shown on the display, connect the cable.**
- 4) **After copying the disk contents to the PC, make the PC ready for disconnecting the PD-6 (such as, moving it to the trash can) before disconnect the IEEE1394 cable.**

<Notes>

Depending on the OS, the PC may automatically mount the PD-6 after unmounting it. In such a circumstance, remove the IEEE1394 cable immediately after unmounting the PD-6.

Example of copying data to an external hard disk

Also note that the procedure below is assumed that the PD-6 is connected to the PC and the “IEEE1394” menu in the Utility mode is set to “CONNECT”.

<Note>

While the “IEEE1394” menu is set to “CONNECT”, the keys and controls on the PD-6 panel are disabled.

1. **Make sure that the PD-6 drive icon is shown on the PC desktop (the icon design differs depending on the PC).**
2. **Start up an appropriate application such as Explorer on the computer, and copy an audio data file in the PD-6 drive to the hard disk.**

Example of exporting data to a computer application

The procedure example below shows how to export PD-6 data to Digidesign Pro Tools for Macintosh.

For details about how to use Pro Tools, see the instructions supplied with the Pro Tools software application. Note that the screen examples below may differ from the screen you actually see.

1. **Start up the application software (Pro Tools, in this example).**
2. **Click “Audio” on the Pro Tools screen to pop up the audio region list menu (indicated by arrow 1).**
3. **Select and click the “Import Audio” menu from the popup menu (indicated by arrow 2).**

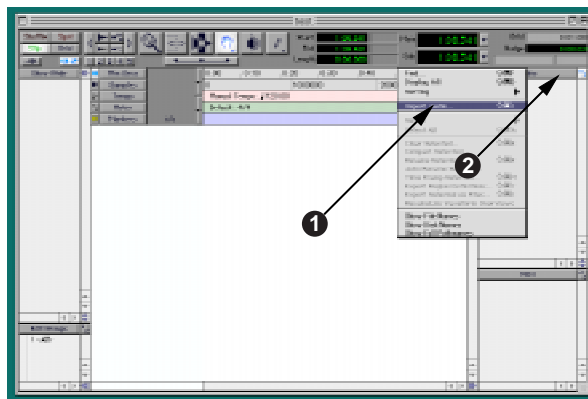

4. **Select and click “PD6-DVD” (or “S001”) on the desktop (indicated by arrow 3).** The disk volume name example shown below is a default tentative name. If you edit the volume name (Reel No.) in the disk formatting process, the edited name is shown.

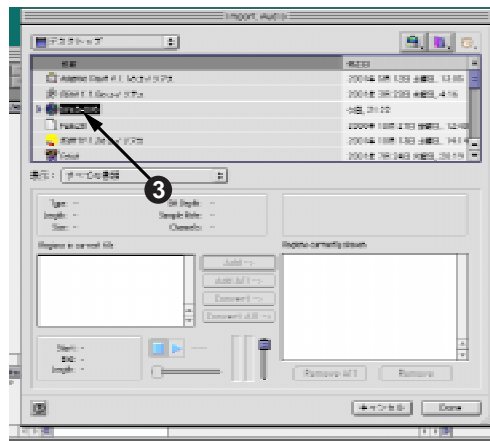

5. **Select and click an audio file in the “bwff” directory on the disk (indicated by arrow 4).**
The selected audio file is shown in “Region in current file”.
6. **Click “Convert ->”, followed by “Done” (indicated by arrow 5).**
The display shows the window for saving a file.

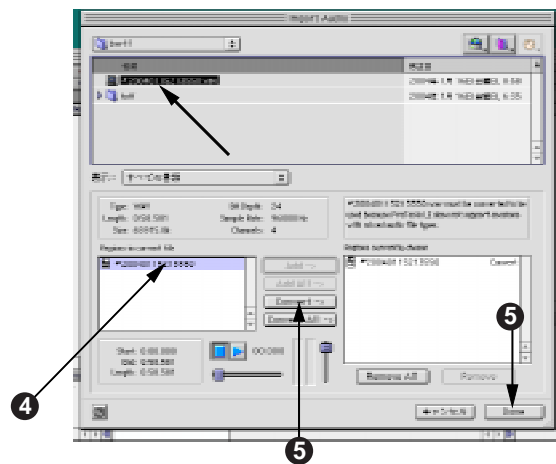

7. **Select a folder to be saved and click “Select” (indicated by arrow 6).**
The computer starts saving the file to the selected folder.

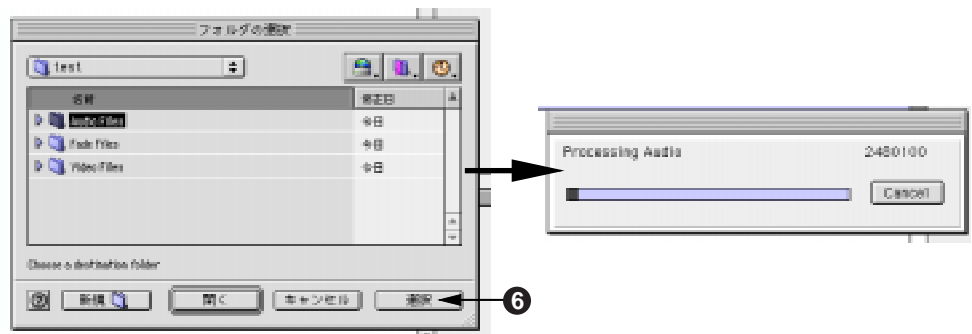

The saved file is added to the audio region list (arrow 7).

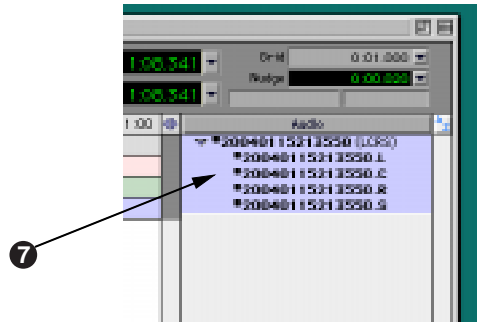

- 8. After making "Spot" active, drag & down the audio region list to the track area (arrow 8).

The "Spot Dialog" setting window appears.

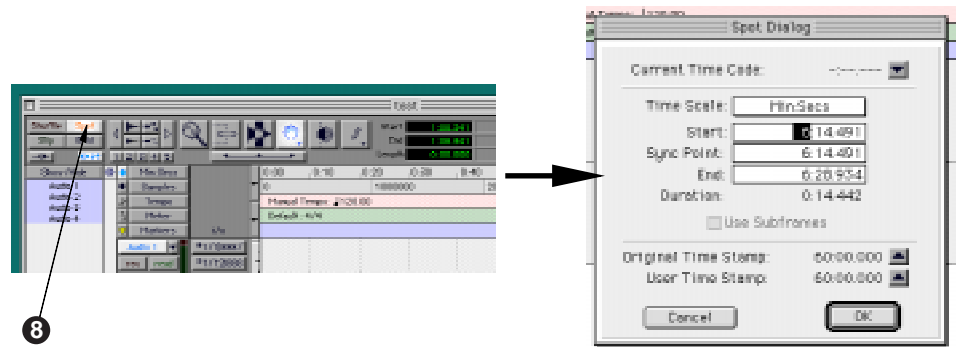

- 9. Click "▲" in the "Spot Dialog" setting window, followed by "OK" (arrow 9).

By clicking "▲", the "original time stamp" time currently shown is set as the "Start" time. Then clicking "OK" starts importing audio data from the specified position.

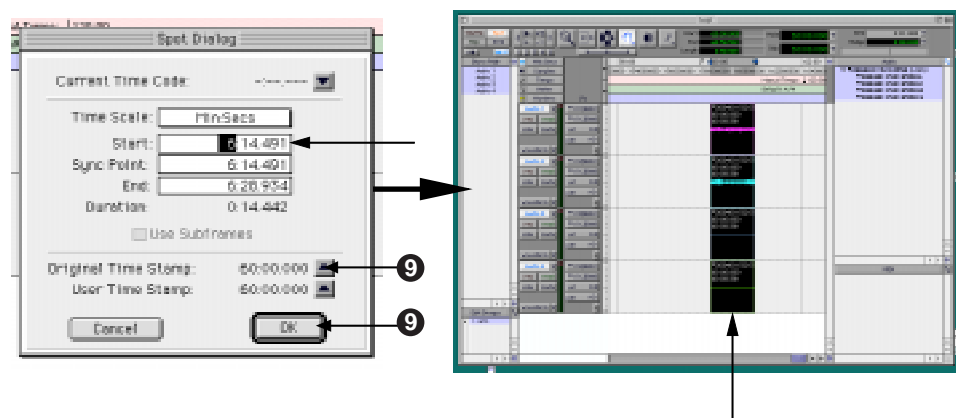

Chapter 11: Specifications

Inputs/Outputs

*0 dBu=0.775 Vrms, 0 dBV=1 Vrms.

Reference level : -18 dB/-20 dB (default: -18 dB, selectable in the "Ref. Level" menu of the Setup mode)

ANALOG MIC/LINE IN (CH 1 through 6)

- Connectors : XLR-3-31 type (balanced, pin 2: hot)

<LINE>

- Input impedance : More than 10kΩ
- Input level : -30 ~ +4dBu (+/-5dB)
- Maximum input level : +24 dBu (+41 dBu at the prefader stage)

<MIC>

- Input impedance : More than 10kΩ
- Input level : -60 ~ -26dBu (+/-5dB)
- Maximum input level : -40 dBu (-23dBu at the prefader stage)

ANALOG LINE OUT (TR 1 through TR 6)

- Connectors : XLR-3-32 type (balanced, pin 2: hot)
- Output load impedance : More than 10kΩ
- Reference output level : +4 dBu
- Maximum output level : +24 dBu

HEADPHONE OUTPUT (SOLO or STEREO/MONO: 1+2, MS, 3/5+4/6, 1/3/5+2/4/6, 3/5+2/4/6, 1/3+2/4, ST, AUX IN, ST. BUS)

- Connector : 6mm dia stereo phone jack
- Applicable load impedance : More than 32Ω
- Maximum output level : 200 mW (at 32Ω)

DIGITAL I/O (for channels 1 through 6)

- Connector : D-sub 25-pin (auto software selection)
- Format
- <Input> : IEC 60958 (S/P DIF) or IEC 60958 (AES/EBU), auto selection
- <Output> : IEC 60958 (S/P DIF) or IEC 60958 (AES/EBU), The format of an output signal is selected in the Setup mode.

TIME CODE INPUT

- Connector : XLR-3-31 type (balanced, pin 2: hot)
- Format : SMPTE/EBU
- Reference input level : 2V p-p
- Input impedance : More than 20kΩ
- Minimum input level : 0.25V p-p

TIME CODE OUTPUT

- Connector : XLR-3-32 type (balanced, pin 2: hot)
- Format : SMPTE/EBU
- Reference output : 2V p-p
- Output impedance : Less than 1kΩ
- Output load impedance : More than 600Ω

VIDEO/WORD INPUT

- Connector : BNC type (auto software selection)
- Reference input level : TTL level (with 75Ω termination switch)
- * The signal type (word or video) is automatically detected.

WORD OUTPUT

- Connector : BNC type
- Output level : TTL level

AATON INPUT / OUTPUT (option)

- Connector : LEMO 5pin
- Format : Complies to ASCII & LTC I/O

AUX INPUT/OUTPUT

- Connector : 10-pin (male)/balanced (Hirose)

<AUX IN>

- Input impedance : More than 10kΩ
- Reference input level : +4dBu
- Maximum input level : +24dBu

<AUX OUT>

- Output load impedance : More than 10kΩ
- Reference output level : +4dBu / -10dBu / -60dBu (switchable)
- Maximum output level : +24 dBu

REMOTE

- Connector : MINI DIN 8pin (female)

IEEE1394

- Connector : P1394a Draft 2.0 4pin

USB

- Connector : Series A Receptable

DC IN

- Connector : XLR-4-32 type
- Input power requirement : 12~18V DC

DC OUT

- Connector : HR10A-7R-4S (Hirose 4-pin female) x2
- Rated output voltage/maximum output current: 12~18V DC/0.5 A (total combined)

MONITOR SPEAKER

- Maximum output level : 720mW

Recording/playback

- Recording device** : ATAPI DVD-RAM drive (8cm)
- Recording Format** : BWF (SDII™ & AIFF planned future option)
- Recording Medium** : 8cm DVD-RAM
- Sampling Frequency** : 44.1 / 48 / 88.2 / 96kHz
- Quantization** : 16bit (44.1 / 48kHz)
: 24bit (44.1 / 48 / 88.2 / 96kHz)
- Recording Track** : 6
- Track mode** : 2track 44.1 / 48 / 88.2 / 96kHz
: 4track 44.1 / 48kHz
: 5track 44.1 / 48kHz
: 6track 44.1 / 48kHz
: 2 + 4track 44.1 / 48kHz
: 1 + 5track 44.1 / 48kHz

R/P Frequency Response	:	20 Hz to 20 kHz, +/-1 dB (fs 44.1kHz / 48kHz)
	:	20 Hz to 40 kHz +/-2 dB (fs 88.2kHz / 96kHz)
Signal to Noise Ratio		
Line	:	100dB (ADC-DAC, 24bit, ref. -20dB, fs: 48kHz) typical
Mic	:	87dB (ADC-DAC, 24bit, ref. -20dB, fs: 48kHz) typical
Dynamic Range	:	100dB (ADC-DAC, 24bit, ref. -20dB, fs: 48kHz) typical
Reference Recording Level	:	-18dB / -20dB (selected the SETUP mode)
T. H. D.	:	Less than 0.01% (1kHz, -1dB, ADC-DAC, 24bit ref.-18dB, fs: 48kHz) typical
Cue Point Chunk	:	100

General

Dimensions	:	110 (H) x 329 (W) x 245 (D) mm
Weight	:	3.4kg (excluding the battery)
Power sources	:	NP-1 type battery or equivalent, IDX NP-L50, IDX NP23 or AC adaptor AD-15C (option, DC 12V to 18V)
Power consumption	:	25 W
Battery life	:	approximately 2 hours (using the IDX NP-L50)

*  is a trademark of DVD format/Logo Licensing Corporation.
 * Specifications and appearance are subject to change without notice for product improvement.

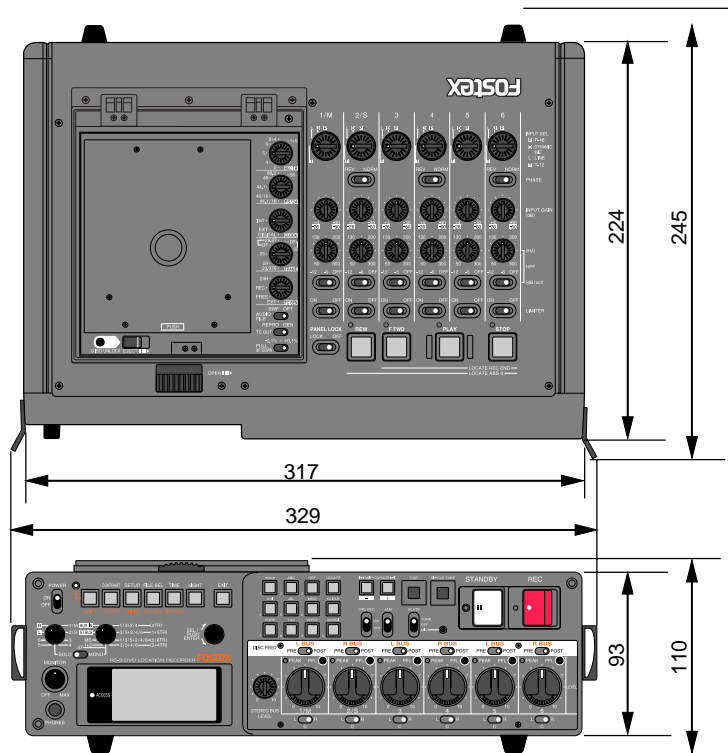

Declaration of EC Directive

This equipment is compatible with the EMC Directive (89/336/EEC) - Directive on approximation of member nation's ordinance concerning the electromagnetic compatibility and with the Low Voltage Directive (73/23/EEC) - Directive on approximation of member nation's ordinance concerning electric equipment designed to be used within the specified voltage range.

The Affect of Immunity on This Equipment

The affect of the European Specification EN61000-6-1 (coexistence of electromagnetic waves - common immunity specification) on this equipment are as shown below.

In the electrical fast transient/burst requirements, surge, conducted disturbances by radio-frequency fields, power frequency magnetic field, radiate electromagnetic field requirements and static electricity discharging environment, this could be affected by generation of noise in some cases.

FOSTEX DISTRIBUTORS LIST IN EUROPE

* Including non-EU countries (as of October, 2003)

<AUSTRIA>

NAME: ATEC Audio-u. Videogeraete VertriebsgesmbH.
ADD: Im Winkel 5, A-2325 Velm, Austria
TEL: (+43) 2234-74004, FAX: (+43) 2234-74074

<BELGIUM>

NAME: General Audio
ADD: Albert Temmerstraat 21, 1731 Zellik, Belgium
TEL: (+32) 2-4630650, FAX: (+32) 2-4661500

<DENMARK>

NAME: SC Sound ApS
ADD: Malervej 2, DK-2630 Taastrup, Denmark
TEL: (+45) 4399-8877, FAX: (+45) 4399-8077

<FINLAND>

NAME: Noretron Oy Audio
ADD: P. O. Box 22, FIN-02631 Espoo, Finland
TEL: (+358) 9-5259330, FAX: (+358) 9-52593352

<FRANCE>

NAME: Sennheiser France
ADD: 128 bis, avenue Jean-Jaures, 94851 Ivry-sur-Seine Cedex, France
TEL: (+33) 1 4987 0300, FAX: (+33) 1 4987 0324

<GERMANY>

NAME: Mega Audio GmbH
ADD: Stromberger Str. 32, D-55411 Bingen, Germany
TEL: (+49) 6721-94330, FAX: (+49) 6721-32046

<GREECE>

NAME: Bon Studio S. A.
ADD: 6 Zaimi Street, Exarchia, 106.83 Athens, Greece
TEL: (+30) 210-3809-605, 606, 607, 608
FAX: (+30) 210-3845-755, 210-3827-868

<ICELAND>

NAME: I. D. elrf. electronic Ltd.
ADD: ARMULA 38 108 REYKJAVIK, ICELAND
TEL: (+354) 588 5010, FAX: (+354) 588 5011

<ITALY>

NAME: Proel S. p. A.
ADD: Zona Via Alla Ruenia, 37/43 64027 - Sant'Omero (Teramo), Italy
TEL: (+39) 0861-81241, FAX: (+39) 0861-887862

<THE NETHERLANDS>

NAME: IEMKE ROOS AUDIO B. V.
ADD: Kuiperbergweg 20, 1101 AG Amsterdam, The Netherlands
TEL: (+31) 20-697-2121, FAX: (+31) 20-697-4201

<NORWAY>

NAME: Fitzpatrick
ADD: P. B. 4316 Nydalen, 0402 Oslo, Norway
TEL: (+47) 23 400 380, FAX: (+47) 23 400 389

<PORTUGAL>

NAME: Caius - Tecnologias Audio e Musica, Lda.
ADD: Praca do Bom Sucesso, No 61 Bom Sucesso Trade Center, Escritorio 701/702, 4150 - 146 Porto, Portugal
TEL: (+351) 22-608-06-10, FAX: (+351) 22-608-06-29

<SPAIN>

NAME: Letusa S. A.
ADD: C/Laguna 10, 28923 Alcorcon, Madrid, Spain
TEL: (+34) 91-4862800, FAX: (+34) 91-6414597

<SWEDEN>

NAME: TTS Scandinavia AB
ADD: Kavallerivagen 24, 172 48 Sundbyberg, Sweden
TEL: (+46) 8-59798000, FAX: (+46) 8-59798001

<SWITZERLAND>

NAME: Audio Bauer Pro AG
ADD: Bernerstrasse-Nord 182, CH-8064 Zurich, Switzerland
TEL: (+41) 1-4323230, FAX: (+41) 1-4326558

<UK>

NAME: SCV London
ADD: 40 Chigwell Lane, Oakwood Hill Industrial Estate, Loughton, Essex IG10 3NY U. K.
TEL: (+44) 20-8418-0778, FAX: (+44) 20-8418-0624

Fostex[®]

FOSTEX CO.

3-2-35, Musashino, Akishima-shi, Tokyo, Japan 196-0021

FOSTEX AMERICA

15431, Blackburn Ave., Norwalk, CA 90650, U. S. A.