

### 32 bit/DAC Headphone amplifier

## HP-A8MK2



Thank you very much for purchasing a Fostex product.  
This manual provides instructions for basic use of the unit.  
Read this before using the unit for the first time.

#### <Note>

Before connecting this product to a Windows computer with a USB cable, install the USB Audio Class 2.0 driver for HP-A8MK2. You can download the driver software from our website below. For Macintosh computers, you can use the product without downloading the driver software. Please use FOSTEX-AudioPlayer (freeware) for audio playback which can be found at the URL below.

<http://www.fostexinternational.com/>

# WARNINGS and PRECAUTIONS

- **CAUTION:** TO PREVENT ELECTRIC SHOCK, MATCH WIDE BLADE OF PLUG TO WIDE SLOT, FULLY INSERT.  
**ATTENTION:** POUR PREVENIR LES CHOCS ELECTRIQUES, APAR DE LA FENTE LARGE, FOND.
- **WARNING:** To reduce the risk of fire or electric shock, do not expose this apparatus to rain or moisture.  
**AVIS:** Pour réduire le risque d'incendie ou de choc électrique, ne pas exposer cet appareil sous la pluie et l'humidité.
- **CAUTION:** Use of any controls or adjustments or performance of procedures other than those herein specified may result in hazardous radiation exposure.  
**ATTENTION:** L'utilisation de tout contrôle ou de réglages ou de procédures autres que celles indiquées ci-après peut entraîner une exposition à des radiations dangereuses.
- **WARNING:** Changes or modifications to this unit not expressly approved by the party responsible for compliance could void the user's authority to operate the equipment.  
**AVIS:** Les changements ou modifications à cette unité n'étant pas expressément approuvés par la partie responsable de la conformité pourraient annuler l'autorité de l'utilisateur de faire fonctionner l'équipement.
- **WARNING:** Do not place the unit on top of any soft, porous, or sensitive surfaces to avoid damaging the surface. Use a protective barrier between the unit and surface to protect the surface.  
**AVIS:** Ne placez pas l'appareil au-dessus de toutes les surfaces souples, poreux, ou sensibles pour éviter d'endommager la surface. Utilisez une barrière de protection entre l'unité et la surface à protéger la surface.
- **WARNING:** Use of this unit near fluorescent lighting may cause interference regarding use of the remote. If the unit is displaying erratic behavior move away from any fluorescent lighting, as it may be the cause.  
**AVIS:** L'utilisation de cet appareil à proximité d'éclairage fluorescent peut provoquer des interférences sur l'utilisation de la télécommande. Si l'appareil affiche un comportement erratique s'éloigner de tout éclairage fluorescent, telle qu'elle peut être la cause.
- **CAUTION:** Danger of explosion if battery is incorrectly replaced. Replace only with the same or equivalent type.

**ATTENTION:** Danger d'explosion si les piles sont remplacées de façon incorrect.  
Remplacer les piles seulement par le même type de pile ou l'équivalent.

- **WARNING:** Do not install this equipment in a confined space such as a book case or similar unit.

**AVIS:** Ne pas installer cet équipement dans un espace confiné comme une bibliothèque ou une unité similaire.

- **WARNING:** Mains plug is used as disconnect device and it should remain readily operable during intended use. In order to disconnect the apparatus from the mains completely, the mains plug should be disconnected from the mains socket outlet completely.

**AVIS:** La prise du secteur est utilisé pour déconnecter le système. La prise du secteur ne doit pas être obstruée ou doit être facilement accessible pendant son utilisation. Pour être complètement déconnecté de l'alimentation d'entrée, la prise doit être débranchée du secteur.

- Do not mix old and new batteries. Do not mix alkaline, standard (carbonzinc), or rechargeable (ni-cad, ni-mh, etc) batteries. Ne mélangez pas une pile neuve et une pile usée. Ne mélangez pas des piles alcalines, standard (carbone-zinc) ou rechargeables (Ni-Cd, Ni-MH, etc).

**CAUTION**  
RISK OF ELECTRIC SHOCK  
DO NOT OPEN

**WARNING:** TO REDUCE THE RISK OF ELECTRIC SHOCK, DO NOT REMOVE COVER (OR BACK).

**AVERTISSEMENT:** POUR RÉDUIRE LE RISQUE DE CHOC ÉLECTRIQUE, NE PAS ENLEVER LE COUVERCLE (NI LE DOS).

NO USER-SERVICEABLE PARTS INSIDE. REFER SERVICING TO QUALIFIED SERVICE PERSONNEL.  
**AUCUNE PIÈCE À L'INTÉRIEUR. ENTRETIEN DE PERSONNEL QUALIFIÉ.**

**ATTENTION**  
RISQUE D'ÉLECTROCUTION  
NE PAS OUVRI

The lightning flash with arrowhead symbol, within an equilateral triangle, is intended to alert the user to the presence of uninsulated "dangerous voltage" within the product's enclosure that may be of sufficient magnitude to constitute a risk of electric shock to persons.



Le symbole de l'éclair fléché dans un triangle équilatéral, est destiné à alerter l'utilisateur de la présence d'une "tension dangereuse" dans le boîtier du produit qui peuvent être des ampleur suffisante pour constituer un risque d'électrocution aux personnes.

# IMPORTANT SAFETY INSTRUCTIONS



- 1) Read these instructions.  
Lisez ces instructions.
- 2) Keep these instructions.  
Conservez ces instructions.
- 3) Heed all warnings.  
Respectez tous les avertissements.
- 4) Follow all instructions.  
Suivez toutes les instructions.
- 5) Do not use this apparatus near water.  
Ne pas utiliser cet appareil près de l'eau.
- 6) Clean only with dry cloth.  
Nettoyer uniquement avec un chiffon sec.
- 7) Do not block any ventilation openings.  
Install in accordance with the manufacturer's instructions.  
Ne pas bloquer les ouvertures de ventilation.  
Installer conformément aux instructions du fabricant.
- 8) Do not install near any heat sources such as radiators, heat registers, stoves, or other apparatus (including amplifiers) that produce heat.  
Ne pas installer près de sources de chaleur telles que radiateurs, registres de chaleur, poêles ou autres appareils (y compris les amplificateurs) produisant de la chaleur.
- 9) Do not defeat the safety purpose of the polarized or grounding-type plug. A polarized plug has two blades with one wider than the other. A grounding type plug has two blades and a third grounding prong. The wide blade or the third prong are provided for your safety. If the provided plug does not fit into your outlet, consult an electrician for replacement of the obsolete outlet.  
Ne détruisez pas la sécurité de la terre ou polarisées - fiche. Une fiche polarisée possède deux lames dont une est plus large que l'autre. Une prise de terre possède deux lames et une broche de terre. La lame large ou la troisième broche sont prévues pour votre sécurité. Si la fiche fournie ne rentre pas dans votre prise, consultez un électricien pour remplacer la prise obsolète.
- 10) Protect the power cord from being walked on or pinched particularly at plugs, convenience receptacles, and the point where they exit from the apparatus.  
Protégez le cordon d'alimentation d'être piétiné ou pincé, particulièrement au niveau des fiches, des prises, et le point où ils sortent de l'appareil.
- 11) Only use attachments/accessories specified by the manufacturer.  
N'utilisez que des accessoires spécifiés par le fabricant.
- 12) Use only with the cart, stand, tripod, bracket, or table specified by the manufacturer, or sold with the apparatus. When a cart is used, use caution when moving the cart/apparatus combination to avoid injury from tipover.  
Utilisez seulement avec la charrette, position, trépied, support ou table spécifiée par le fabricant, ou a vendu avec l'appareil .  
Lorsqu'une charrette est utilisée, utilisez la prudence quand déplacer la combinaison de charrette / appareil pour éviter la blessure de pointe-sur.
- 13) Unplug this apparatus during lightning storms or when unused for long periods of time.  
Débranchez cet appareil pendant les orages ou lorsqu'il n'est pas utilisé pendant de longues périodes de temps.
- 14) Refer all servicing to qualified service personnel. Servicing is required when the apparatus has been damaged in any way, such as power supply cord or plug is damaged, liquid has been spilled or objects have fallen into the apparatus, the apparatus has been exposed to rain or moisture, does not operate normally, or has been dropped.  
Confiez toute réparation à un personnel qualifié. Une réparation est nécessaire lorsque l'appareil a été endommagé de quelque façon que ce cordon d'alimentation ou la fiche est endommagé, liquide a été renversé ou des objets sont tombés dans l'appareil, l'appareil a été exposé à la pluie ou à l'humidité, ne fonctionne pas normalement, ou s'il est tombé.
- 15) The apparatus shall be used in an open area.  
Cet appareil doit être utilisé dans un endroit a aire ouverte.
- 16) Apparatus shall not be exposed to dripping or splashing and that no objects filled with liquids, such as vases, shall be placed on apparatus.  
L'appareil ne doit pas éclaboussures et aucun objet ne contenant de liquide, tel qu'un vase, ne doit être placé sur l'objet.
- 17) Mains plug is used as disconnect device. It shall remain readily operable and should not be obstructed during intended use. To completely disconnect the apparatus from supply mains, the main plug of the apparatus shall be disconnected from the mains socket outlet completely.  
La prise du secteur et utilisé pou déconnecter le système. La prise du secteur ne doit pas être obstruée ou doit être facilement accessible pendant son utilisation. Pour être complètement déconnecté de l'alimentation d'entrée, la prise doit être débranchée du secteur.

**FCC (U.S.A.) & ICES-003 (Canada) INFORMATION****1. IMPORTANT NOTICE**

This product, when installed as indicated in the instructions contained in this manual, meets FCC and ICES-003 requirements. Changes or modifications not expressly approved by Fostex Company for compliance could void the user's authority to operate the equipment. DO NOT MODIFY THIS PRODUCT.

**2. IMPORTANT**

In order to comply with FCC and ICES-003 requirements, use high quality shielded cables for connection to accessories and / or another products. If any cables are supplied with this product, they MUST be used. Follow all installation instructions. Failure to do so could void your FCC / ICES-003 authorization to use this product in the USA / Canada.

**3. NOTE**

This equipment has been tested and found to comply with the limits for a Class B digital device, pursuant to Part 15 of the FCC Rules. These limits are designed to provide reasonable protection against harmful interference in a residential installation. This equipment generates, uses and can radiate radio frequency energy and, if not installed and used in accordance with instructions, may cause harmful interference to radio communications. However, there is no guarantee that interference will not occur in a particular installation.

If this equipment does cause harmful interference to radio or television reception, which can be determined by turning the equipment off and on, the user is encouraged to correct the interference by one or more of the following measures:

- Reorient or relocate the receiving antenna.
- Increase the separation between the equipment and receiver.
- Connect the equipment into an outlet on a circuit different from that to which the receiver is connected.
- Consult the dealer or an experienced radio/TV technician for help.

**4. Compliance with Part 15 of FCC Rules and Canadian ICES-003.**

This device complies with Part 15 of the FCC Rules.

Operation is subject to the following two conditions:

- (1) This device may not cause harmful interference, and
- (2) this device must accept any interference received, including interference that may cause undesired operation.

This Class B digital apparatus complies with Canadian ICES-003.

Cet appareil numérique de la classe B est conforme à la norme NMB-003 du Canada.

# Contents

<b>WARNINGS and PRECAUTIONS.....</b>	<b>2</b>
<b>IMPORTANT SAFETY INSTRUCTIONS .....</b>	<b>3</b>
<b>Introductions .....</b>	<b>5</b>
Features of the HP-A8MK2 .....	5
Accessories.....	5
<b>Functions.....</b>	<b>6</b>
Front panel.....	6
Rear panel.....	7
Remote controller.....	8
<b>Connecting external audio devices.....</b>	<b>9</b>
<b>Connecting output devices.....</b>	<b>10</b>
Connecting the power cord.....	10
<b>Listening to an external audio device... </b>	<b>11</b>
Listening to the external device.....	11
<b>Listening to the files on an SD card .....</b>	<b>12</b>
Playable files .....	12
Hierarchy example in the SD card .....	12
Ejecting the SD card .....	13
Using the remote controller .....	13
<b>Changing the settings .....</b>	<b>14</b>
Setting item list .....	14
<b>Troubleshooting .....</b>	<b>17</b>
Resetting the product.....	17
Updating the version .....	18
<b>Specifications.....</b>	<b>19</b>

- \* Microsoft, Windows and Windows Vista are either registered trademarks or trademarks of Microsoft Corporation in the United States and/or other countries.
- \* Apple, Macintosh, Mac and Mac OS are trademarks of Apple Inc., registered in the U.S. and other countries. Other company names and product names in this document are the trademarks or registered trademarks of their respective owners.
- \* All other company names, product names and logos are trademarks or registered trademarks of their respective owners.
- \* "DSD" is a trademark.
- \* ASIO is a trademark of Steinberg Media Technologies GmbH.

**<ErP Directive>****European model only**

The HP-A8MK2 conforms to ErP directive and pursues energy efficiency. When the operation continues for about 30 minutes, it will automatically turn OFF the power. This mode can be disabled by the "AUTO POWER OFF" on the Setting item list.

# Introductions

HP-A8MK2 is a DAC headphone amplifier with high efficiency, high-quality sound. You can enjoy high-quality digital audio signals from your computer or from a digital audio player.

## ■ Features of the HP-A8MK2

- Headphone amplifier equipped with high-quality sound 32bit-DAC (AK4490) and all discrete circuit.
- Supports a sampling frequency of up to 32 bit/192 kHz through in house developed USB driver. In addition, supports DSD 11.2 MHz (ASIO).
  - \* DSD playback on Mac is compatible up to 5.6 MHz.
- Eliminates the jitter caused by low accuracy of the source clock of the computer, etc. by using the asynchronous mode of an SPXO for audio (crystal oscillator).
- Equipped with high-quality sound, high-accuracy electronic volume for audio level control.
- Equipped with a large capacity toroidal power transformer.
- Computers, and digital and analog audio devices can be used as the input source.
- Plays DSF files, WAV files and AIFF files on an SD (SDHC) card directly using built-in SD (SDHC) card drive. The drive can also be used for future updates.
  - \* There are several conditions for playback from an SD card. For more information, please refer to "Listening to the files on an SD card" on page 12.
- Equipped with an analog output terminal (RCA pin jack).
- Both the internal clock and the external clock are available for the master clock (only for SPDIF).
- 2x or 4x upsampling function (can also be turned off).
- Switchable digital filter.
- 24 level gain settings for headphone output.
- Direct analog output that does not pass through the volume.
- Equipped with an infrared remote controller.
- Equipped with an organic EL display.
- Equipped with independent clocks for 44.1K factor and 48K factor.

## ■ Accessories

Supplied accessories are listed below. Confirm that accessories are present after purchase.

- Remote controller × 1
- AAA battery for remote controller × 2
- Power cord × 1
- Owner's Manual (this book) × 1
- Safety information × 1

# Functions

## ■ Front panel

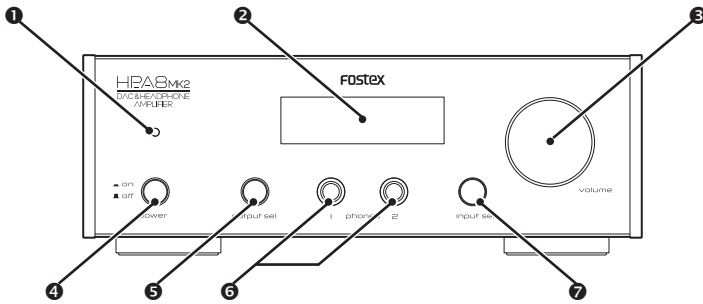

### ❶ Power indicator

Lights in red when the power is **on**.

### ❷ Display

Various information (⇒page 11, 13) and menu screen (⇒page 14) are displayed.

### ❸ volume knob

Adjusts the volume of the headphones or the analog output.

#### 🔔 Note

- You can not adjust the analog output volume when the "DIRECT" setting is set to "ON" (⇒page 15).

### ❹ power switch

Switches the power on/off. The recessed position is **on**.  
When set up item "AUTO POWER OFF" is set to "ON", the HP-A8<sub>MK2</sub> will automatically turn OFF the power. Press the switch twice to return the power ON. You can disable "AUTO POWER OFF" mode by Setting item.

### ❺ output sel switch

Switches the output source. Outputs the signal from analog output terminal at the recessed position.

### ❻ [phones] terminals (1/2)

Connect the headphones with a standard stereo jack. Up to 2 pairs of headphones can be connected at the same time.

### ❼ input sel knob/switch

Turn the knob clockwise or counter-clockwise to switch the input source (⇒page 11).

Also, press and hold the switch to display the menu screen, and press to select a menu item. (⇒page 14).

## ■ Rear panel

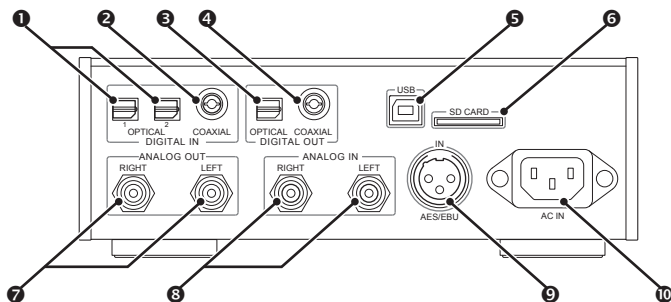

### ❶ [DIGITAL IN - OPTICAL (1/2)] terminals

Connect a digital audio device as an input source using a square optical cable. Up to two devices can be connected.

### ❷ [DIGITAL IN - COAXIAL] terminal

Connect a digital audio device as an input source using a coaxial cable.

### ❸ [DIGITAL OUT - OPTICAL] terminal

Outputs a digital audio signal to the connected digital audio device via a square optical cable.

### ❹ [DIGITAL OUT - COAXIAL] terminal

Outputs a digital audio signal to the connected digital audio device via a coaxial cable.

### ❺ [USB] terminal

Connect a computer (Win/Mac) as an input source using a USB cable.

### ❻ [SD CARD] slot

Insert an SD (SDHC) card including WAV files, AIFF files or DSF files with the label side facing upward.

### ❼ [ANALOG OUT] terminals (RIGHT/LEFT)

Connect a device such as an amplifier using an RCA pin cable.

### ❸ [ANALOG IN] terminals (RIGHT/LEFT)

Connect an analog audio device as an input source using an RCA pin cable.

### ❹ [AES/EBU] terminal (IN)

Connect a digital audio device as an input source using an AES/EBU cable.

### ❺ [AC IN] terminal

Connect the supplied power cable.

### 🔧 Note

- S/PDIF format is used for digital audio input/output.
- The signal is always output from the [DIGITAL OUT] terminal regardless of the "OUTPUT SEL" setting (⇒ page 11, 13). Digital signal does not output when the input source is set to [ANALOG IN] ("RCA") or a DSD signal is input.

## Remote controller

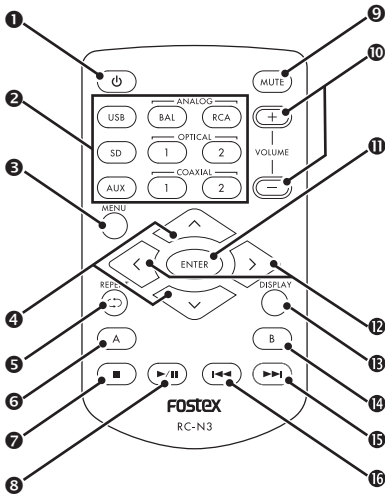

### Note

- The included battery is for checking operation. Replace it as soon as possible.
- Read "Safety information" (attached sheet) and handle the battery correctly.
- Dispose of the battery in the proper manner according to the local regulations.

### 1 Power key

Not used.

### 2 Input source selection keys

Selects the input source.

USB: [USB] terminal

SD: [SD CARD] slot

AUX: [AES/EBU] terminal

ANALOG BAL: Not used

ANALOG RCA: [ANALOG IN] terminal

OPTICAL1: [DIGITAL IN - OPTICAL 1] terminal

OPTICAL2: [DIGITAL IN - OPTICAL 2] terminal

COAXIAL1: [DIGITAL IN - COAXIAL] terminal

COAXIAL2: Not used

### 3 MENU key

Displays the menu screen.

### 4 $\wedge$ / $\vee$ keys

Selects folders when using an SD card.

### 5 Repeat key

Turns the repeat function on/off when using an SD card.

### 6 A key

Not used.

### 7 Stop key

Stops playback when using an SD card.

### 8 Play/Pause key

Starts/pauses playback when using an SD card.

### 9 MUTE key

Mutes/restores the sound each time it is pressed.

### 10 VOLUME +/- keys

Adjusts the volume.

### 11 ENTER key

Determines the selected menu or value, or unmounts the SD card.

### 12 $\leftarrow$ / $\rightarrow$ keys

Selects items and values on the menu screen.

### 13 DISPLAY key

Turns the display on/off.

### 14 B key

Not used.

### 15 Next track key

While using an SD card, moves to the next track when pressed, and fast-forwards the currently playing track when held down.

### 16 Previous track key

While using an SD card, moves to the previous track when pressed, and fast-rewinds the currently playing track when held down.



# Connecting external audio devices

Connect a digital audio device as an input source to the digital audio input terminal, square optical terminals [OPTICAL 1]/[OPTICAL 2], the coaxial terminal [COAXIAL] or the AES/EBU terminal [AES/EBU].

Connect an analog audio device as an input source to the analog audio input terminal [ANALOG IN].

To listen to music files from a computer, connect the computer to the USB terminal [USB].

To change the input source, turn the **input sel** knob on the front panel.

## Note

- Do not connect the power cord until all connections are finished.

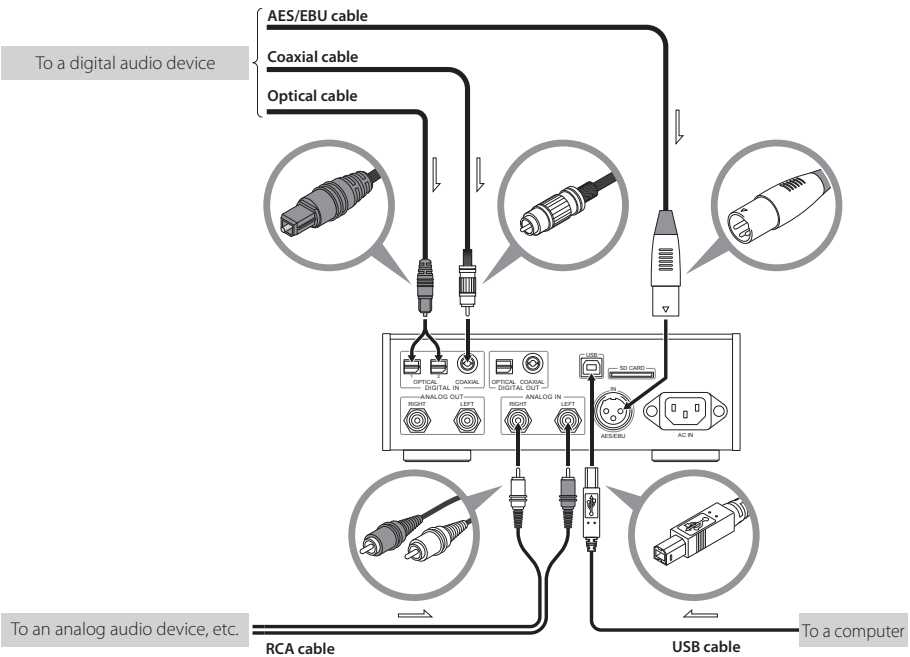

# Connecting output devices

Connect headphones to the headphone terminals [phones] (1/2) on the front panel, or connect an amplifier or active speaker to the analog output terminal [ANALOG OUT] to enjoy music. To change the output, use the **output sel** switch on the left side of the front panel. You can obtain S/PDIF format signals through the square optical terminal [OPTICAL] or coaxial terminal [COAXIAL] when connecting a digital audio device.

## Note

- Do not connect the power cord until all connections are finished.
- The signal is always output from the [DIGITAL OUT] terminal regardless of the "OUTPUT SEL" setting (⇒ page 11, 13). Digital signal does not output when the input source is set to [ANALOG IN] ("RCA") or a DSD signal is input.

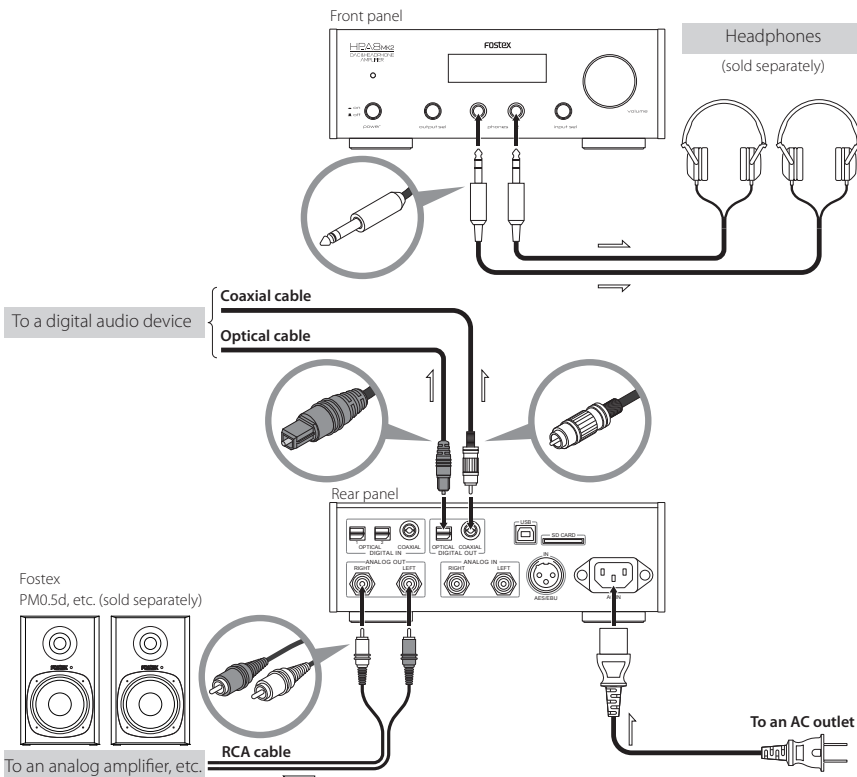

## ■ Connecting the power cord

Connect the power cord after all connections are finished.

# Listening to an external audio device

You can enjoy music from the external audio device connected to the unit through headphone output or analog output.  
Connect the desired device before the operation. (⇒page 9)

## ■ Listening to the external device

### 1 Turn on the product.

Push in the **power** switch.  
The power indicator lights in red when the power is on.

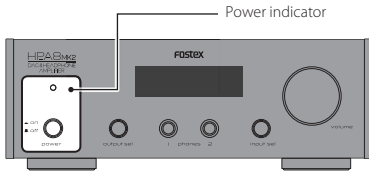

#### Note

- When an amplifier is connected, turn the volume of the amplifier to the minimum before powering on the product.

### 2 Select the input source.

Turn the **input sel** knob on the main unit, or use the Input source selection keys on the remote controller.

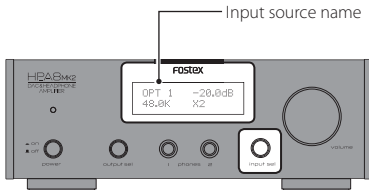

- **"AES/EBU"**: Device connected to [AES/EBU]
- **"USB"**: Computer connected to [USB]
- **"RCA"**: Device connected to [ANALOG IN]
- **"SD"**: Inserted SD card (⇒page 12)
- **"COX"**: Device connected to [DIGITAL IN - COAXIAL]
- **"OPT1"**: Device connected to [DIGITAL IN - OPTICAL 1]
- **"OPT2"**: Device connected to [DIGITAL IN - OPTICAL 2]

### 3 Select the output source.

Select headphones or analog output.



#### • Listening via headphones:

Do not push in the **output sel** switch



#### • Listening via analog output:

Push in the **output sel** switch



### 4 Adjust the volume.

Turn the **volume** knob on the main unit, or press the **VOLUME +/-** keys on the remote controller.



#### Note

- You cannot adjust the analog output volume when the "DIRECT" setting is set to "ON".

#### <Display during playback>



Sampling frequency (Fs)

# Listening to the files on an SD card

You can enjoy DSF files, WAV files and AIFF files.

## Note

- To make folders on or copy files to an SD card, please use a computer. The unit does not support these operations.

## Playable files

### Note

- Format the card in FAT32.
- The maximum number of folders you can create on an SD card is 15.
- The maximum number of files you can copy in each folder is 30.
- You can use up to 50 alphanumeric characters for folder names, 70 characters for file names. 2 byte characters are displayed as "□".

### DSF files (extension: .dsf)

- Format: 2.8 MHz

### WAV files (extension: .wav),

### AIFF files (extension: .aiff)

- Sampling frequency: 44.1 kHz to 192 kHz
- Bit rate: 16 Bit, 24 Bit, 32 Bit
- Format: Linear PCM

## Hierarchy example in the SD card

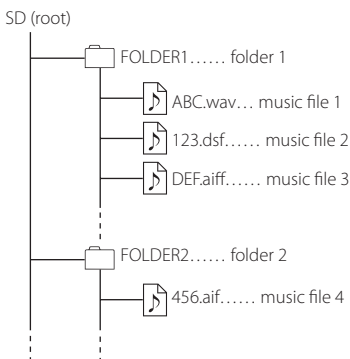

## 1 Insert an SD card.

Insert an SD (SDHC) card into the [SD CARD] slot on the rear panel with the label side facing upward.

[SD CARD] slot

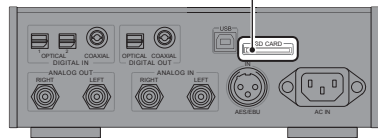

## 2 Turn on the product.

Push in the **power** switch.

The power indicator lights in red when the power is on.

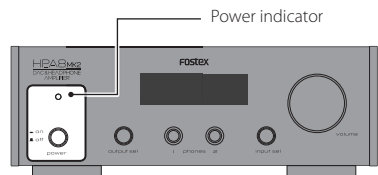

## Note

- When an amplifier is connected, turn the volume of the amplifier to the minimum before turning on the product.

## 3 Select the input source.

Turn the **input sel** knob on the main unit, or press the **SD** key on the remote controller to select "**SD**".

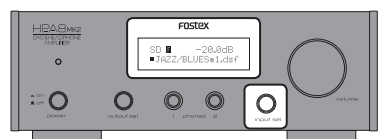

#### 4 Select the output source.

Select headphones or analog output.



##### • Listening via headphones:

Do not push in the **output sel** switch



##### • Listening via analog output:

Push in the **output sel** switch



#### 5 Adjust the volume.

Turn the **volume** knob on the main unit, or press the **VOLUME +/-** keys on the remote controller.



#### Note

- You cannot adjust the analog output volume when the "DIRECT" setting is set to "ON".

#### <Display during playback>

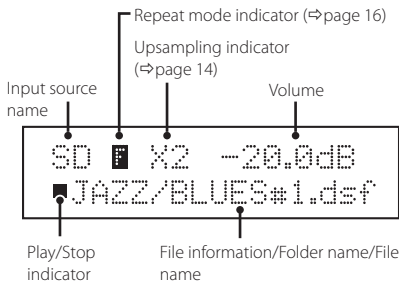

### Ejecting the SD card

Unmount the SD card by the following procedure before ejection. Otherwise, the data may be damaged.

#### 1 Stop playback.

Press the **■** key on the remote controller.

#### 2 Press the ENTER key on the remote controller.

SD (SDHC) card is unmounted, and "EJECT" is displayed.

#### 3 Push in the card gently until a clicking sound is heard.

The card pops out a little.

#### 4 Grasp the card and pull it out straight.

### Using the remote controller

You can control the product using the remote controller.

▶/||| : Start/pause playback of current file

■ : Stop playback

ENTER : Select a folder or unmount the SD card

▶▶▶ : Press to move to next track/hold to fast-forward

◀◀◀ : Press to move to previous track/hold to fast-rewind

▲ : Next folder

▼ : Previous folder

↻ : Repeat on/off

#### Note

- You can select the repeat playback range with the "SD REPEAT MODE" setting (⇒ page 16).
- If you change the settings on the menu screen during SD card playback, the changes are stored when you stop playback. Also, the volume setting of the "IN/VOL MEM" setting is stored when you stop playback.

# Changing the settings

You can change the settings according to your environment.

- 1 Press and hold the input sel switch on the main unit or press the MENU key on the remote controller.



```
→ AMP GAIN
    0dB
```

The menu screen is displayed.

- 2 Turn the input sel knob on the main unit or press the </> key on the remote controller to select the item to change.

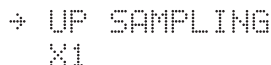

```
→ UP SAMPLING
    X1
```

"→" on the first line indicates the selected item.

- 3 Press the input sel switch on the main unit or press the ENTER key on the remote controller to select the current item.

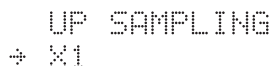

```
UP SAMPLING
→ X1
```

"→" on the second line indicates the selected setting value.

- 4 Turn the input sel knob on the main unit or press the </> key on the remote controller to select the setting value.



```
UP SAMPLING
→ X2
```

- 5 Press the input sel switch on the main unit or press the ENTER key on the remote controller to apply the current setting value.

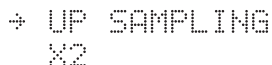

```
→ UP SAMPLING
    X2
```

- 6 Press and hold the input sel switch on the main unit or press the MENU key on the remote controller.

The display changes from the menu screen to the normal screen.

## ■ Setting item list

Setting item	Setting value
"AMP GAIN" Selects the gain according to the sensitivity of your headphones.	Default: "0 dB" "0 dB" to "20 dB" (0.5 dB step)
"UP SAMPLING" Activates the upsampling function.	Default: "x1" "x 1", "x 2", "x 4" * The product upsamples up to 192 kHz. This function does not affect DSD signals.

Setting item	Setting value
<p><b>"DIGITAL FILTER"</b> Selects the digital filter.</p>	<p>Default: <b>"SHORT DLY SHAP"</b> You can select from one of the 5 types of digital filters listed below. <b>"SHORT DLY SHAP"</b> <b>"SHORT DLY SLOW"</b> <b>"SHARP ROLL-OFF"</b> <b>"SLOW ROLL-OFF"</b> <b>"SUPER SLOW"</b></p>
<p><b>"MSCK SEL"</b> Selects the master clock of the DAC. * The internal clock is always used when the input source is set to "USB" or "SD" regardless of this setting.</p>	<p>Default: <b>"DIR"</b> <b>"DIR"</b> Uses the external clock of the digital input source. <b>"XTAL"</b> Uses the high precision internal SPXO clock.</p>
<p><b>"DIRECT"</b> Selects whether the signal for the [ANALOG OUT] terminal goes through <b>volume</b> or not. * The signals for headphones always go through <b>volume</b> regardless of this setting.</p>	<p>Default: <b>"OFF"</b> <b>"OFF"</b> Goes through <b>volume</b> (You can change the volume with <b>volume</b>) <b>"ON"</b> Does not go through <b>volume</b> (You can not change the volume with <b>volume</b>) When you change the setting value and press the <b>ENTER</b> key, "WARNING" is displayed, then "ARE YOU SURE?" will be displayed. Press the <b>ENTER</b> key again to determine the setting value.</p>
<p><b>"IN/VOL MEM"</b> Activates the memory function of the last source and volume.</p>	<p>Default: <b>"DISABLE"</b> <b>"DISABLE"</b> The last source and volume are not memorized. <b>"INPUT"</b> Switches to the last source automatically at power on. The volume is set to MUTE. <b>"VOLUME"</b> Switches to the last volume automatically at power on. The source is set to "COX". <b>"INPUT+VOLUME"</b> Switches to the last source and volume automatically at power on.</p>

Setting item	Setting value
<p><b>"USB MUTE SEL"</b> Activates cross-fade processing (volume down) between files when the input source is set to "USB".</p>	<p>Default: <b>"OFF"</b> <b>"OFF"</b> Play the signal from USB directly. A snapping noise may be produced between files. <b>"ON"</b> Activates cross-fade processing at the beginning and end of the file. For the continuously recorded sound source, such as a live recording album, sound may be interrupted for a moment.</p>
<p><b>"SD REPEAT MODE"</b> Selects the repeat range of the SD card playback.</p>	<p>Default: <b>"FOLDER"</b> <b>"FOLDER"</b> Repeats the current folder ("F" indicator is displayed). <b>"ALL"</b> Repeats the whole card ("A" indicator is displayed). <b>"SINGLE"</b> Repeats the current file ("1" indicator is displayed).</p>
<p><b>"LCD ON/OFF"</b> Selects the lighting pattern of the LCD display.</p>	<p>Default: <b>"ON"</b> <b>"ON"</b> LCD is always on. <b>"OFF"</b> The LCD turns off automatically approximately 8 seconds after the last operation is performed.</p>
<p><b>"AUTO POWER OFF"</b> Selects the "AUTO POWER OFF" mode ON or OFF.</p>	<p>Default: <b>"ON"</b> <b>"ON":</b> The HP-A8<sub>MK2</sub> will automatically turn OFF the power, when the operation continues for about 30 minutes. <b>"OFF":</b> The HP-A8<sub>MK2</sub> does not automatically power OFF. i.e., it keeps powering ON even after 30 minutes of operation.</p>
<p><b>"SYSTEM INFO"</b> Displays the current software version.</p>	<p>Default: <b>"VerX.XXX"</b> <b>"VerX.XXX"</b> Current version. <b>"VERSION UP"</b> Executes the update. (⇒page 18) <b>"RESET"</b> Returns to the factory settings (⇒page 17).</p>



# Troubleshooting

Common problems and solutions are listed below.

Problem	Solutions
There is no sound.	<ul style="list-style-type: none"><li>• Confirm that the product is connected properly (⇒page 9).</li><li>• Confirm that the input source is selected properly. (⇒page 11)</li><li>• Confirm that the output source is selected properly. (⇒page 11)</li></ul>
Cannot be recognized from a Windows PC.	<ul style="list-style-type: none"><li>• Download the driver from our site and install.</li></ul>
Cannot playback the SD card.	<ul style="list-style-type: none"><li>• The files may not be played back if the transfer rate is insufficient. Use a Class 6 or higher SDHC card.</li><li>• We do not guarantee the operation of all cards. Try a different card. In addition, this product does not support SDXC cards.</li></ul>

## ■ Resetting the product

You can reset the product back to the factory settings.

### 1 Select "RESET" on the "SYSTEM INFO" setting in menu screen.

All settings are set to the default settings.

## ■ Updating the version

An update file may be released to solve problems and provide a better listening environment. Update the product by the following procedure.

### 1 Save the obtained update file on an SD (SDHC) card.

Save the file in the root directory.

**Note**

- Format the card in FAT32.
- Do not save files other than the update file on the SD card.

### 2 Insert the card into the slot on the rear panel with the label side facing upward.

### 3 Turn on the product, and select "COX" as the input source.

### 4 Press and hold the input sel switch on the main unit or press the MENU key on the remote controller to display the menu screen.

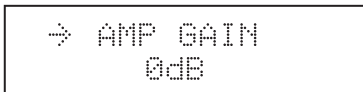

### 5 Select "SYSTEM INFO" from the menu item.

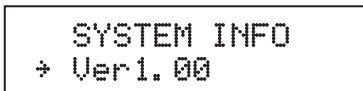

The current version is displayed.

### 6 Select "VERSION UP" from the setting value.

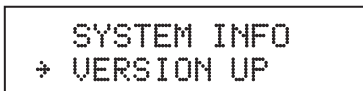

### 7 Select "VERSION UP".

Updating starts.

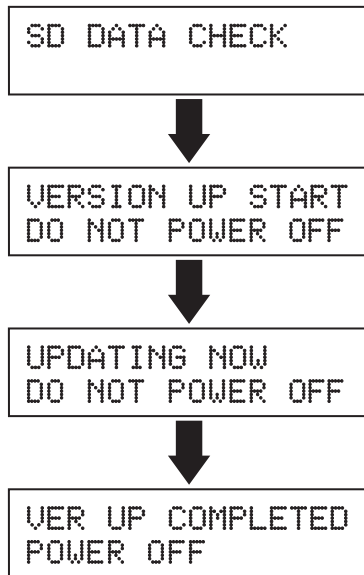

It takes about 30 seconds to finish updating. Wait until "VER UP COMPLETED/POWER OFF" or "VERSION UP END/POWER OFF" is displayed, and do not turn off the product during updating.

### 8 Turn off the product.

The update is now completed.

**Note**

- Refer page 14 for menu screen operations.
- All settings will return to the factory settings after updating.

# Specifications

## <Input>

USB terminal	
Connector	B type (Standard)
Quantization, sampling frequency	16/24/32 bit, 44.1 kHz/48 kHz/88.2 kHz/96 kHz/176.4 kHz/192 kHz, DSD 2.8 MHz/5.6 MHz/11.2 MHz (ASIO) * DSD playback on Mac is compatible up to 5.6 MHz.
Interface	USB High Speed
DIGITAL INPUT-OPTICAL (1, 2) terminal	
Connector	Square optical
Format	S/P DIF
Quantization, sampling frequency	16/24 bit, 44.1 kHz/48 kHz/88.2 kHz/96 kHz/176.4 kHz/192 kHz
DIGITAL INPUT-COAXIAL terminal	
Connector	RCA pin jack
Format	S/P DIF
Quantization, sampling frequency	16/24 bit, 44.1 kHz/48 kHz/88.2 kHz/96 kHz/176.4 kHz/192 kHz
DIGITAL INPUT-AES/EBU terminal	
Connector	XLR-3-31 type (No.2 hot)
Format	AES/EBU
Quantization, sampling frequency	16/24 bit, 44.1 kHz/48 kHz/88.2 kHz/96 kHz/176.4 kHz/192 kHz
ANALOG INPUT (L, R) terminal	
Connector	RCA pin jack
SD card	
Card	SDHC
File system	FAT32
Format	DSF/WAV/AIFF
Quantization, sampling frequency	16/24/32 bit, 44.1 kHz to 192 kHz, DSD 2.8 MHz

## <Output>

PHONES (1, 2) terminal	
Connector	Standard stereo jack
Maximum output	700 mW (load resistance 32 Ω)
Conformity load impedance	16 Ω to 600 Ω
THD	0.002% or less (at 1 kHz, load resistance 32 Ω, 1 Vrms)
Frequency response	10 Hz to 80 kHz ± 3 dB
ANALOG OUTPUT (L, R) terminal	
Connector	RCA pin jack
Conformity load impedance	10 kΩ or more
THD	0.002% or less
Frequency response	10 Hz to 80 kHz ±3 dB (at 192 kHz usage)
DIGITAL OUTPUT-OPTICAL terminal	
Connector	Square optical
Format	S/P DIF
Quantization, sampling frequency	16/24 bit, 44.1 kHz/48 kHz/88.2 kHz/96 kHz/176.4 kHz/192 kHz
DIGITAL OUTPUT-COAXIAL terminal	
Connector	RCA pin jack
Format	S/P DIF
Quantization, sampling frequency	16/24 bit, 44.1 kHz/48 kHz/88.2 kHz/96 kHz/176.4 kHz/192 kHz

## <General>

Accessories	Remote controller (x 1), AAA battery for remote controller (x 2), Power cord (x 1), Owner's Manual (this book) (x 1)*, Safety information (x 1) *1: Addendums for added settings, etc. will be attached at each update.
External dimensions (mm)	213 (W) x 78 (H, including legs) x 315 (D, including protrusions)
Weight	Approx. 3.8 kg
Power input	AC 100 V
Power consumption	24 W

\* This product is compatible with European RoHS Directive.

# Declaration of EC Directive

This equipment is compatible with the EMC Directive (2004/108/EC) - Directive on approximation of member nation's ordinance concerning the electromagnetic compatibility and with the Low Voltage Directive (2006/95/EC) - Directive on approximation of member nation's ordinance concerning electric equipment designed to be used within the specified voltage range. This equipment is also compatible with the Ecodesign Directive (2009/125/EC) - Directive on approximation of member nation's ordinance concerning the ecodesign requirement for energy-using products and with EU RoHS 2 Directive (2011/65/EU) - Directive on approximation of member nation's ordinance concerning the restriction of the use of certain hazardous substances in electric equipment.

## The Affect of Immunity on This Equipment

The affect of the European Specification EN61000-6-1 (coexistence of electromagnetic waves - common immunity specification) on this equipment are as shown below.

In the electrical fast transient/burst requirements, surge, conducted disturbances by radio-frequency fields, power frequency magnetic field, radiate electromagnetic field requirements and static electricity discharging environment, this could be affected by generation of noise in some cases.

## FOSTEX DISTRIBUTORS LIST IN EUROPE

\* Including non-EU countries (as of Jan. 2016)

### Albania, Bosnia and Herzegovina, Croatia, Kosovo, Macedonia, Montenegro, Serbia & Slovenia

NAME: Player Plus d.o.o.  
ADD: St. Sestara Strain 17/13, 11080 Belgrade, Serbia  
TEL: (+381) 11 377 4968, FAX: (+381) 11 377 4969  
Email: info@players.rs  
Web Site: <http://www.players.rs>

### Austria, Germany & Hungary

NAME: Mega Audio GmbH  
ADD: Feldborn 3, in 55444 Waldlaubersheim, Germany  
TEL: (+49) 6721-94330, FAX: (+49) 6721-32046  
Email: info@megaaudio.de  
Web Site: <http://www.megaaudio.de>

### Belgium

NAME: XLR sprl/bvba  
ADD: Pierre Strauvenstraat 24, 1020 Brussels, Belgium  
TEL: (+32) 2 520 8827, FAX: (+32) 2 521 1977  
Email: info@xlrspo.be  
Web Site: <http://www.xlrspo.be>

### Czechia

NAME: Praha Music Center spol s.r.o.  
ADD: Ocelarska 937/39, Praha 9, 190 00, Czechia  
TEL: (+420) 226-011-111  
FAX: (+420) 226-011-112  
Email: info@pmcc.cz  
Web Site: <http://www.pmcc.cz>

### Denmark

NAME: SC Sound A/S  
ADD: Dalgas Alle 15, DK-6600 Vejen, Denmark  
TEL: (+45) 4399 8877, FAX: (+45) 4399 8077  
Email: mail@sc-sound.dk  
Web Site: <http://www.sc-sound.dk>

### Estonia, Latvia & Lithuania

NAME: Mafico BV  
ADD: Weg en Bos 2 2661 DH Bergschenhoek Nederland  
TEL: (+31) (0)10 - 414 8426  
FAX: (+31) (0)10 - 404 8863  
Email: info@mafico.com  
Web Site: <http://www.mafico.com>

### Finland

NAME: Noreton Oy Audio  
ADD: Mankkaantie 32, FIN-02180 ESPOO, Finland  
TEL: (+358) 10-525-8000  
FAX: (+358) 10-525-8010  
Web Site: <http://www.noreton.fi>

### France

NAME: Hamy Sound (Consumer and Hi-Fi Systems)  
ADD: 28 Rue Edith Cavell, 92400 Courvoisio, France  
TEL: (+33) 1 4788 4702, FAX: (+33) 1 4789 4872  
Email: say@hamysound.com  
Web Site: <http://www.hamysound.com>

### France

NAME: Selectronic (Speaker Components)  
ADD: Zac de L'Oree du Golf, 16 rue Jules Verne, 59790 Ronchin, France  
TEL: (+33) 328 550 328, FAX: (+33) 328 550 329  
Email: contact@selectronic.fr

### France

NAME: Sennheiser France (Pro-Audio)  
ADD: 128 bis, avenue Jean-Jaures, 94851 Ivry-sur-Seine Cedex, France  
TEL: (+33) 1 4987 0300, FAX: (+33) 1 4987 0324  
Web Site: <http://www.sennheiser.fr>

### Greece

NAME: Bon Studio S.A  
ADD: 621 Strimiti Street, Exarchia, 106 83 Athens, Greece  
TEL: (+30) 210-3809-605, 606, 607, 608  
FAX: (+30) 210-3845-755, 210-3827-868  
Email: bon@bonstudio.gr  
Web Site: <http://www.bonstudio.gr>

### Italy

NAME: Art of Music sas (Consumer/Hi-Fi Systems/ Speaker Components)  
ADD: Via Dal Lino 23/2, 40134 Bologna, Italy  
TEL: (+39) 347 2532215  
Email: artofmusic@libero.it  
Web Site: <http://www.artofmusic.it>

### Italy

NAME: Backline S.r.l. (Pro-Audio)  
ADD: Via dell'Aprica, 16 - 20158 Milano, Italy  
TEL: (+39) 02 6901 5709, FAX: (+39) 02 6901 5645  
Email: info@backline.it  
Web Site: <http://www.backline.it>

### The Netherlands

NAME: Iemke Roos Audio B.V.  
ADD: Kuiperbergweg 20, 1101 AG Amsterdam, The Netherlands  
TEL: (+31) 20-697-2121, FAX: (+31) 20-697-4201  
Email: sales@iemkeros.nl  
Web Site: <http://www.iemkeros.nl>

### Norway

NAME: Siv. Ing. Benum AS  
ADD: Østre Aker vei 68, 0581 OSLO  
TEL: (+47) 2213 9900, FAX: (+47) 2214 8259  
Email: Norway@benum.com  
Web Site: <http://www.benum.no>

### Poland

NAME: Mega Music Spolka z o.o  
ADD: Ul. Lesna 15, 81-876 Sopot, Poland  
TEL: (+48) 58-551-18-82  
FAX: (+48) 58-551-18-72  
Email: prog@megamusical.pl  
Web Site: <http://pro.megamusical.pl>

### Portugal & Spain

NAME: AITCONSUMER (Consumer/Hi-Fi Systems/ Speaker Components)  
ADD: PO BOX 15, 08340 Vilassar de Mar, Barcelona, Spain  
TEL: (+34) 609 288310  
Email: info@atconsumer.es  
Web Site: <http://www.atconsumer.es>

### Portugal & Spain

NAME: LETUSA S.A. (Pro-Audio)  
ADD: C/Laguna No.10, Poligono Industrial Urtinsa, 28923 Alcorcon, Madrid, Spain  
TEL: (+34) 91-486-2800, FAX: (+34) 91-6414597  
Email: info@letusa.es  
Web Site: <http://www.letusa.es>

### Russia

NAME: Audio Mania LLC (Speaker Components)  
ADD: 107023 Barabanniy Lane 4/4, Moscow Russia  
TEL: +7 495 2680468  
Email: info@audiomania.ru  
Web Site: <http://www.audiomania.ru>

### Russia

NAME: BLADE Group of Companies (Consumer)  
ADD: Elizavetinsky per, 12 Moscow 105005, Russia  
TEL: +7 495 276 2076, FAX: +7 495 276 2076  
Email: info@blade.ru  
Web Site: <http://www.blade.ru/>

### Russia

NAME: MS-MAX (Pro-Audio)  
ADD: Entrance 128, Kutuzovskiy prospekt, 30/32, 121165, Moscow, Russia  
TEL: (+7) 495-234-0006, FAX: (+7) 495-249-8034  
Email: office@ms-max.ru  
Web Site: <http://www.ms-max.ru>

### Russia

NAME: Ovinta Company LLC (Hi-Fi Systems)  
ADD: Building 2, Street 26A, Dmitriy Uliyaynaya, Moscow 117036 Russia  
TEL: +7 495 787 7767

### Slovakia

NAME: Rockcentrum  
ADD: Ambra Pietra 40, 036 01 Martin, Slovakia  
TEL: (+421) 43 41 36336, FAX: (+421) 43 41 36337  
Email: rock-centrum@rock-centrum.sk  
Web Site: <http://rock-centrum.sk>

### Sweden

NAME: Benum Nordic AS  
ADD: Vastberga Allé 26, 126 30 Hagersten, Sweden  
TEL: (+46) 8 207710  
Email: sweden@benum.com  
Web Site: <http://www.benum.se>

### Switzerland

NAME: Audio Bauer Pro AG  
ADD: Bernerstrasse-Nord 182, CH-8064 Zurich, Switzerland  
TEL: (+41) 44 432 3230, FAX: (+41) 44 432 6558  
Email: info@audio-bauerpro.ch  
Web Site: <http://www.audio-bauerpro.ch>

### Turkey

NAME: Extreme Audio (Consumer/Hi-Fi Systems)  
ADD: Sheraton Istanbul Maslak Kat B2 Buyukdere Cad. Nr:233 Uçyol Mevki 34398 Maslak Istanbul Turkey  
TEL: +90 444 3760, FAX: +90 212 285 0073  
Email: bahadi@extreme-audio.com  
Web Site: <http://www.extreme-audio.com>

### Turkey

NAME: Radikal Elektronik Ltd. Sti. (Pro-Audio)  
ADD: Iblamur-Yıldız Cad, Kessaf Sok. 4/12 Besiktas, Istanbul 34353, Turkey  
TEL: (+90) (212) 259 7971  
FAX: (+90) (212) 259 7993  
Email: radikal@radikaltr.com  
Web Site: <http://www.radikaltr.com>

### UK

NAME: Pro-Hifi (Consumer/Hi-Fi Systems)  
ADD: Unit C1 Belcon Industrial Estate, Geddings Road, Hoddesdon, Hertfordshire, EN11 0NT, UK  
TEL: (+44) (0)3301 22 2500  
FAX: (+44) (0)1992 44 9171  
Email: info@pro-hifi.co.uk  
Web Site: <http://www.pro-hifi.co.uk>

### UK

NAME: SCV Distribution (Pro Audio/Speaker Components)  
ADD: Unit C1 Belcon Industrial Estate, Geddings Road, Hoddesdon, Hertfordshire, EN11 0NT, UK  
TEL: (+44) (0)3301 22 2500  
FAX: (+44) (0)1992 44 9171  
Email: fostex@scvdistribution.co.uk  
Web Site: <http://www.scvdistribution.co.uk>

### Ukraine

NAME: A & T Trade Petroshev  
ADD: 29, Obolon'skaya Str., Kiev, Ukraine 04071  
TEL: (+380) 44-537-3356  
FAX: (+380) 44-462-5092  
Email: atrade@atrade.kiev.ua  
Web Site: <http://kiev.attrade.ru>

# FOSTEX

## FOSTEX CO.

1-1-109, Tsutsujigaoka, Akishima City, Tokyo, 196-8550, Japan