



DVD MULTITRACK RECORDER **DV824**



Owner's Manual

Fostex[®]

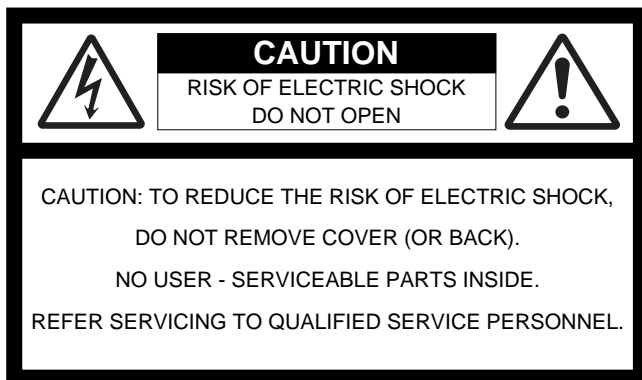

CAUTION:

TO PREVENT ELECTRIC SHOCK, MATCH WIDE BLADE OF PLUG TO WIDE SLOT, FULLY INSERT.

ATTENTION:

POUR ÉVITER LES CHOCS ÉLECTRIQUES, INTRODUIRE LA LAME LA PLUS LARGE DE LA FICHE DANS LA BORNE CORRESPONDANTE DE LA PRISE ET POUSSER JUSQU' AU FOND.

"WARNING"

"TO REDUCE THE RISK OF FIRE OR ELECTRIC SHOCK, DO NOT EXPOSE THIS APPLIANCE TO RAIN OR MOISTURE."

SAFETY INSTRUCTIONS

1. Read Instructions - All the safety and operating instructions should be read before the appliance is operated.
2. Retain Instructions - The safety and operating instructions should be retained for future reference.
3. Heed Warnings - All warnings on the appliance and in the operating instructions should be adhered to.
4. Follow Instructions - All operating and use instructions should be followed.
5. Water and Moisture - The appliance should not be used near water - for example, near a bathtub, washbowl, kitchen sink, laundry tub, in a wet basement, or near a swimming pool, and the like.
6. Carts and Stands - The appliance should be used only with a cart or stand that is recommended by the manufacturer.



An appliance and cart combination should be moved with care. Quick stops, excessive force, and uneven surfaces may cause the appliance and cart combination to overturn.

7. Wall or Ceiling Mounting - The appliance should be mounted to a wall or ceiling only as recommended by the manufacturer.
8. Ventilation - The appliance should be situated so that its location or position does not interfere with its proper ventilation. For example, the appliance should not be situated on a bed, sofa, rug, or similar surface that may block the ventilation openings; or, placed in a built-in installation, such as a bookcase or cabinet that may impede the flow of air through the ventilation openings.
9. Heat - The appliance should be situated away from heat sources such as radiators, heat registers, stoves, or other appliances (including amplifiers) that produce heat.
10. Power Sources - The appliance should be connected to a power supply only of the type described in the operating instructions or as marked on the appliance.



The lightning flash with arrowhead symbol, within an equilateral triangle, is intended to alert the user to the presence of uninsulated "dangerous voltage" within the product's enclosure that may be of sufficient magnitude to constitute a risk of electric shock to persons.



The exclamation point within an equilateral triangle is intended to alert the user to the presence of important operating and maintenance (servicing) instructions in the literature accompanying the appliance.

11. Grounding or Polarization - The precautions that should be taken so that the grounding or polarization means of an appliance is not defeated.
12. Power Cord Protection - Power supply cords should be routed so that they are not likely to be walked on or pinched by items placed upon or against them, paying particular attention to cords at plugs, convenience receptacles, and the point where they exit from the appliance.
13. Cleaning - The appliance should be cleaned only with dry cloth.
14. Nonuse Periods - The power cord of the appliance should be unplugged from the outlet when left unused for a long period of time.
15. Object and Liquid Entry - Care should be taken so that objects do not fall and liquids are not spilled into the enclosure through openings.
16. Damage Requiring Service - The appliance should be serviced by qualified service personnel when:
 - A. The power supply cord or the plug has been damaged; or
 - B. Objects have fallen, or liquid has been spilled into the appliance;
 or
 - C. The appliance has been exposed to rain; or
 - D. The appliance does not appear to operate normally or exhibits a marked change in performance; or
 - E. The appliance has been dropped, or the enclosure damaged.
17. Servicing - The user should not attempt to service the appliance beyond that described in the operating instructions. All other servicing should be referred to qualified service personnel.
18. The appliance should be situated away from drops of water or spray of water.
19. Objects containing liquid such as vase must not be put on the appliance.
20. The appliance is not completely isolated from the power supply even if the power switch is at off position.
21. Appliance shall not be exposed to dripping or splashing and no objects filled with liquids, such as vases, shall be placed on the appliance.
22. Only use attachments/accessories specified by the manufacturer.

Important Safety Instructions

- 1) Read these instructions.
- 2) Keep these instructions.
- 3) Heed all warnings.
- 4) Follow all instructions.
- 5) Do not use this apparatus near water.
- 6) Clean only with dry cloth.
- 7) Do not block any ventilation openings. Install in accordance with the manufacturer's instructions.
- 8) Do not install near any heat sources such as radiators, heat registers, stoves, or other apparatus (including amplifiers) that produce heat.
- 9) Do not defeat the safety purpose of the polarized or grounding-type plug. A polarized plug has two blades with one wider than the other. A grounding type plug has two blades and a third grounding prong. The wide blade or the third prong are provided for your safety. If the provided plug does not fit into your outlet, consult an electrician for replacement of the obsolete outlet.
- 10) Protect the power cord from being walked on or pinched particularly at plugs, convenience receptacles, and the point where they exit from the apparatus.
- 11) Only use attachments/accessories specified by the manufacturer.
- 12) Use only with the cart, stand, tripod, bracket, or table specified by the manufacturer, or sold with the apparatus. When a cart is used, use caution when moving the cart/apparatus combination to avoid injury from tip-over.
- 13) Unplug this apparatus during lightning storms or when unused for long periods of time.
- 14) Refer all servicing to qualified service personnel. Servicing is required when the apparatus has been damaged in any way, such as power-supply cord or plug is damaged, liquid has been spilled or objects have fallen into the apparatus, the apparatus has been exposed to rain or moisture, does not operate normally, or has been dropped.



Table of contents

About this manual	9
Precautions	9
Precautions of installation	10
Chapter-1: Introduction	11
Main features/functions	12
What is in the box	13
DV824 options and related Fostex products	13
Chapter-2: Preparation before using the DV824	15
Power (AC adaptor) connection	16
Turning of the power	16
Realtime clock setting	17
About recommended disks	18
Inserting/removing a disk	18
Initial format of a DVD-RAM disk	20
Adjusting display contrast	22
Chapter-3: Names and functions	23
Front panel	24
Rear panel	30
Display	33
Home screen	33
File name	33
Next file name	33
Disk remaining	33
File number	33
File protection	33
Status information	34
Screen examples	35
7-segment LED time indicator	36
Chapter-4: Connection	37
Basic connection	38
Analog audio input connection	38
Digital audio input connection	38
External parallel controller connection	39
External video editor connection	39
Sync signal (word clock) connection	39
Ethernet connection	39
Connection for optional cards	40
Time code input/output connection (for the optional TC/SYNC card)	40
Connection to a film machine (for the optional TC/SYNC card)	40
Connection to a personal computer (for the optional IEEE1394/USB card)	40

Other connection	41
USB keyboard connection	41
Chapter-5: Recording/playback	43
Basic audio recording	44
Setup for recording in quick setup mode	44
Entering the quick setup mode	45
Input signal selection	45
TC frame rate selection	46
System clock reference selection	47
Sampling frequency and bit length selection	47
TC generator setting	47
Recording track selection	48
Clock pull up/pull down setting	48
Next file name setting	49
Other settings	50
Reference level setting	50
Recording level setting	50
Digital input channel selection	50
Time display mode selection	51
Headphone monitor selection	51
Starting recording	52
Canceling recording (False start)	54
Recording in Pre rec mode	54
Recording the slate tone	55
Cue point setting	56
Setting a cue point on the fly during audio recording	56
Viewing the cue point list	56
Editing a cue point	57
Editing a cue label	57
Editing cue point data	58
Deleting a cue point	58
Adding a new cue point to the cue point list	58
Basic playback	59
Normal playback	59
Cueing playback	60
Skip/locate functions	61
Skipping through files	61
Skipping through cue points	61
Locating to the beginning or end of a file	61
Locating to the last locate point	61
Locating to a desired time point	62
Locating to a desired cue point	62
Chapter-6: Advanced operations	63
Audio CD playback	64
Setting CD stop mode	65
List play function	66
Setting list play mode/Executing list play	68

Viewing linked audio files	70
Locating to the beginning of the play list	70
Locating to the end of the play list	70
Controlling the unit from a video editor	71
Necessary setting (RS422 SETUP menu)	71
RS422 remote setting	71
Device type setting	72
Sync play setting	72
Editor preset setting	72
File data transfer using FTP server function	73
Setting example of PC connection	74
Connecting DV824 directly to PC	74
Connecting DV824 to LAN	75
FTP command details	75
TCP/IP SETUP menu setting	76
IP address setting	76
Subnet mask setting	76
Anonymous on/off setting	77
Login name/password setting	77
TCP/IP Enable mode on/off setting	77
Mac address checking	77
File transfer example between the DV824 and a PC.....	78
Time code recording/playback (the optional Model 8348 required)	80
Recording time code	80
Frame rate setting	80
TC generator mode setting	80
Playing back time code	81
Time code output setting	81
Jam function (the optional Model 8348 required)	81
Executing jam function	82
Auto copy function (the optional Model 9057 required)	83
Setting auto copy mode	83
Making auto copy	85
Disk copy function (the optional Model 9057 required)	86
Making Disk copy	86
File copy function (the optional Model 9057 required)	87
Making File copy	87
Dual drive recording (the optional Model 9057 required)	89
Formatting in the “DDR” mode	89
Making dual drive recording	91
Chasing external TC (the optional Model 8348 required)	92
Preparations	92
Chasing	92
Data export to PC (the optional Model 8370 required)	93
Connecting PC to the unit	94
How to unmount the DV824 from the PC	94
Example of copying data to a computer hard disk	94
Example of exporting data to a computer application	95

Chapter-7: Creating and editing ALE files (EDIT EDL FILE menu)	99
Creating a new ALE file	100
Adding audio file entries to an ALE file	103
Viewing and editing audio file entries	105
Viewing audio file entries	105
Adding an audio file entry to an existing ALE file	106
Deleting an audio file entry	106
Editing an ALE file	107
Editing an ALE file	107
Remarking an ALE file	108
Deleting an ALE file	109
Chapter-8: MENU mode	111
About MENU mode	112
“SYS SETUP” menu	113
Basic procedure for using the “SYS SETUP” menu	114
Default file name setting [Default file name]	115
Default track name setting [Default track name]	116
Next event number setting [Next event No.]	116
Recording track setting [Record tracks]	117
Recording FS/bit length setting [Record FS&Bit]	117
Pull up/down setting [Pull Up/Down]	118
Maximum file length setting [Max file length]	118
Input selection [Select input]	119
Digital input channel setting [Setup digital in]	119
Digital output signal format selection [Digital out]	120
Pre recording time setting [Pre rec time]	120
Auto EE mode selection [Auto EE mode]	121
Slate tone/pop tone recording mode setting [Tone rec mode]	121
Peak hold time setting [Peak hold]	122
Reference level setting [Reference level]	122
Skip mode setting [Skip mode]	123
Diagnoses file setting [Diagnoses]	123
USB keyboard type setting [Keyboard]	123
Startup disk selection [Startup disk]	124
ROM version checking [Version]	124
“TC SETUP” menu	125
Basic procedure for using the “TC SETUP” menu	126
System clock selection [Sync clock]	127
TC frame rate selection [Frame rate]	127
Generator mode selection [Gen mode]	128
Internal TC generator setting [Set Gen TC]	128
Jam mode setting [JAM mode]	130
User bit setting [Gen Ubit]	130
Time code output source selection [Sel. TC Out]	131
Default LTC start time setting [Default LTC start]	131
LTC start time editing [Edit LTC start]	132
UBIT setting of playback time code [Ref TC Ubit]	133
Time code output while paused [Rep pause TC]	134
Reference time code selection [Ref TC sel]	134

Chase mode selection [Chase mode]	135
Chase offset setting [Chase offset]	136
Chase offset editing	136
Chase offset trimming	137
Chase offset	137
Synchronization to a film machine [Bi-Phase setup]	138
Resetting the current film position to the start time	138
Editing the film start time	139
Setting the number of pulses per frame	139
Setting the film leader length and film size	139
“DISK UTILITY” menu	140
Basic procedure for using the “DISK UTILITY” menu	141
Editing a file name [Edit file name]	142
Viewing a file information and editing descriptor information [File info.]	143
Viewing file information	143
Viewing descriptor information	143
Editing descriptor information	145
Adding descriptor information	145
Deleting descriptor information	145
Deleting an unnecessary audio file [Delete file]	146
Restoring a deleted audio file [Restore Del. file]	147
Optimizing a disk [Optimize disk]	148
Formatting a disk [Format]	149
Editing the reel number (volume label) [Reel No.]	152
Record protection On/Off setting [Rec protect]	153
Resume function On/Off setting [Resume]	154
Partition protection On/Off setting [Part. protect]	154
“LOAD SETUP” menu	155
“SAVE SETUP” menu	156
Chapter-9: Specifications	157

About this manual

This manual intends to be used as a guide for using the Fostex DV824 DVD multitrack recorder.

This manual is written assuming that you have experience of using professional digital recorders and basic knowledge of digital recording.

By reading "Chapter 1: Introduction" and "Chapter 3: Names and functions", you may roughly understand the outline of the DV824 and how to use the DV824.

Chapter 3 can be used as the index because we not only briefly describe functions of each control but also show the page where details are described.

"Chapter 2: Preparation before using the DV824" describes information for using the DV824 for the first time, such as power connection and initial formatting of the supplied DVD-RAM disk.

Precautions

- For supplying the power to the unit, only use the Fostex Model AD-15C adaptor (the AD15C is supplied with the unit).
If you use any other AC adaptor, the unit may not work correctly and there is a serious risk of damage to the unit.
- Make sure that the voltage of your AC power outlet matches the voltage requirements printed on the AC adaptor.
If you wish to use the unit in a country where the voltage of the AC power outlet does not match your AC adaptor, ask your local Fostex dealer or service station for purchasing an appropriate AC adaptor.
Note that the AC adaptor can be used both in 50 Hz and 60 Hz areas.
- Never supply voltage other than DC12V to the unit.
- When disconnecting the AC adaptor, make sure that the unit [POWER] switch is set to "OFF".
Disconnecting the AC adaptor while the power is "ON" may damage data because the unit always handles data.
- While the unit is accessing to a disk (for example, during recording), never turn off the power. Make sure that the unit completely stops accessing to the disk before you turn off the power. Otherwise, recorded data may be lost, as well as the disk may be damaged.

<Note>: Note that Fostex assumes no responsibility on data loss or whatsoever due to use of the unit.

<Note>: Fostex is not responsible for any "direct damage" or "indirect damage" caused by using the unit.

- Do not let water or other liquid, or metal objects such as pins, accidentally enter the inside of the unit (especially inside of the disk tray) because this may lead to electric shock or damage. Should water enter the inside of the unit, turn off the power, unplug the AC adaptor and remove batteries, and consult your dealer or the nearest FOSTEX service station.

- Do not drop the unit or give it a strong shock. The internal circuits, display, panels may be damaged. Handle the unit with great care because it is a precision machine.
- To prevent possible electric shock and damage to the unit, do not remove the cover or reach the inside of the unit.
- Do not give a strong shock to the LCD display. The liquid used inside the LCD display is toxic. If the liquid is spilled, do not suck it in. If it is stained to your hand or skin, wash immediately with plenty of water.

<About replacing the lithium battery>

The DV824 uses a lithium battery internally. To replace the battery, ask your dealer or the nearest FOSTEX service station. If the battery is not correctly replaced, there may be a risk of explosion, etc.

Precautions on installation

Do not install the unit in the following conditions.

- * In an extremely hot or cold place
 - * In a moist place
 - * In a shaky or unstable place
 - * In a dusty place
 - * In a strong magnetic field or near a device which generates a magnetic field
 - * In the direct sunshine
 - * In the direct rain or water
- **Notes on moisture condensation**
When you bring the unit from a cold place to a warm place, moisture may condense on the drive, display, panels, etc. In such a case, leave the unit for a while until it warms up and evaporates any moisture.

Chapter-1: Introduction

Main features/functions

- Equipped with an E-IDE 12-centimeter DVD-RAM drive. This drive ensures high-speed access and reliability, which only the optical disk system can afford.
- The DVD-RAM disk format is conformed to "UDF Rev1.5", which ensures compatibility with personal computers.
- The recording file format is conformed to the BWF interleave 1 file specification. When a file is imported to a DAW from the DV824, it can be separated to multiple mono files. (Note that the DAW must support interleave files.)
- In addition to mono-track and stereo-track modes, 4-, 5-, 6- and 8-track modes are available for recording.
- Supports word synchronization as standard, allowing the DV824 synchronized with external digital devices.
- By installing the optional TC/SYNC card, you can record a time code generated by the internal TC generator (in +/- 1 PPM accuracy) or an external SMPTE/EBU time code, along with audio signals. The recorded time code data is stored to the Time Stamp (Time Reference) of the BWF file. You can also synchronize the DV824 to a film machine.
- Built in ether card. The DV824 can be an FTP server, allowing you to transfer audio file data between the DV824 and your personal computer via TCP/IP.
- By creating an ALE file from a recorded audio file, you can export it to the AVID system.
- By installing the optional 2.5-inch hard disk drive, you can make "Auto copy", "File Copy" and "Disk Copy" between a DVD-RAM disk and a hard disk partition, as well as "Dual Drive Recording".
- By installing the optional IEEE1394 USB2 card, you can directly connect the DV824 to a personal computer. It allows exporting audio file data recorded by the DV824 to your personal computer.
- A USB port is provided for connecting to a USB keyboard. You can enter or edit a file name, volume name, etc. from a keyboard instead of the DV824 panel keys.
- The Mark/Cue function allows to store markers (cue points) during recording. You can locate or skip to a cue point quickly.
- The "False start" function allows to cancel recording easily.
- "Pre Record" function allows glitch-free recording. When this function is active, recent audio data is pooled in the buffer and recording starts from the audio data in the buffer.

What is in the box

Make sure that the box contains the following. If any of them are missing, please contact your dealer.

• DV824	(x 1)
• 12-centimeter DVD-RAM disk (4.7GB/Type 2)	(x 1)
• AC adaptor (Model AD-15C)	(x 1)
• Operation manual (this manual)	(x 1)

DV824 options and related Fostex products

The following DV824 options and related products are available. Ask your local Fostex dealer or sale office for details about them such as prices, specifications, etc. You can also get product information from our web site.

<http://www.fostex.com>

Options

- TC/SYNC card: Model 8348 (available soon)
- 2.5-inch hard disk drive: Model 9057 (available soon)
- IEEE1394/USB card: Model 8370 (available soon)

Related products

- DVD location recorder: Model PD-6
- Portable location recorder: Model FR-2
- Personal powered monitor: Model 6301B/BX
- Stereo headphones: Model T20RPMkII/T-5/T-7/T-40RPMkII/T50RP

Chapter-2: Preparation before using the DV824

This chapter explains what you should do before using the DV824 for the first time, including power connection, internal clock setting and initial formatting of the DVD-RAM disk supplied with the unit.

Table of contents

Power (AC adaptor) connection	16
Turning on the power	16
Realtime clock setting	17
About recommended disks	18
Inserting/removing a disk	18
Initial format of a DVD-RAM disk	20
Adjusting display contrast	22

Power connection

Connect the supplied AC adaptor as shown below.

<Notes>: Only use the AC adaptor provided. Using another AC adaptor may cause damage of the unit due to the mismatch of the power voltage or polarity. Also make sure that the power of the unit is off when plugging or unplugging the AC adaptor connector.

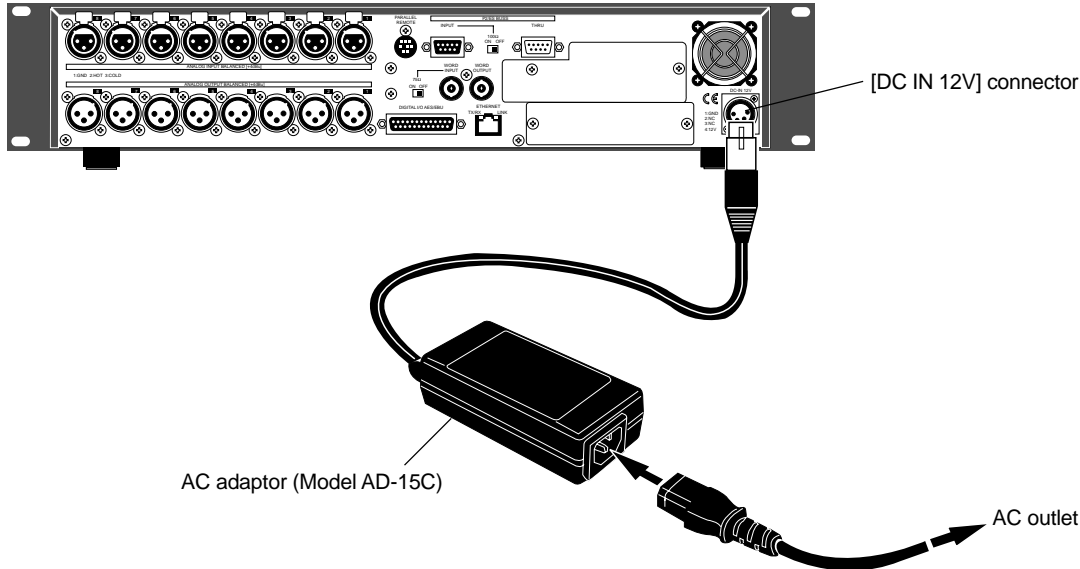

Turning on the power

When turning on the power of the unit, the display shows the starting-up screen, and the unit starts up. If no DVD-RAM disk is set in the DVD-RAM drive of the unit, "--No disk--" is shown in the file name area on the display, while "--H --M --S --F" is shown on the time display.

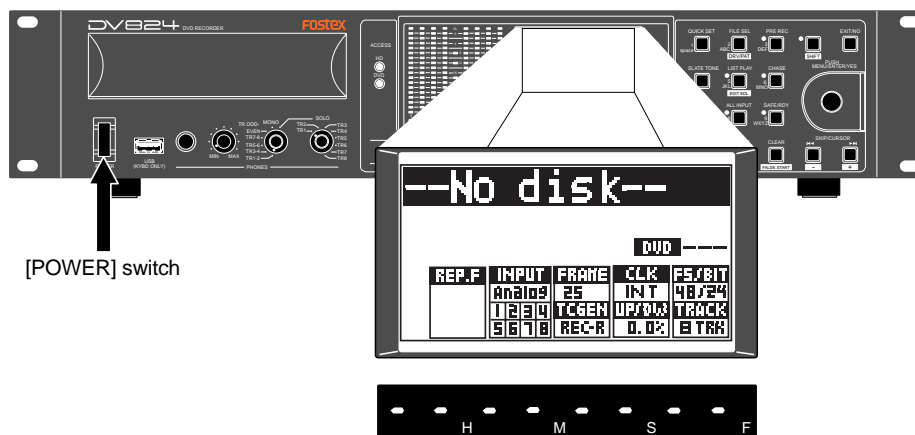

After starting up as shown above, set the internal clock to the current date/time by following the procedure described in "Realtime clock setting" on the next page.

Realtime clock setting

The realtime clock is built in the DV824.

The realtime clock data is used for date/time of creation of a file.

By default, the realtime clock is set according to local date/time of the factory. Therefore, set the clock correctly according to your local date/time before using.

<Note>: You can record the realtime clock data as the TC start time time only when the optional TC/SYNC card is installed and the "Gen Mode" item (for TC recording mode setting) of the "TC SETUP" menu in the MENU mode is set to "24H Run" (see page 128 for details).

- 1) After turning on the power of the unit, press the [ENTER/YES] key to enter the MENU mode.

The display now shows the MENU list screen on which "SYS SETUP" is highlighted.

```
MENU▶
SYS SETUP▶
TC SETUP▶
DISK UTILITY▶
TCP/IP SETUP▶
RS422 SETUP▶
FILE SEL▶
```

- 2) Press the [ENTER/YES] key again.

The display now shows the "SYS SETUP" menu.

```
MENU▶SYS▶
Default file name▶
Default track name▶
Next event No:00001
Record tracks: 8
Record FS&Bit:48k/24
Full Up/Down: 0.0%
```

- 3) Use the [MENU] dial to highlight "Adjust RTC" and press the [ENTER/YES] key.

The display now shows current clock data which runs in realtime.

```
MENU▶SYS▶
Diagnoses:On
Keyboard:US
Startup disk:DVD
CD stop mode:CD end
Adjust RTC▶
Version▶
```

```
SYS▶Adjust RTC
---Lookup RTC---
'04Y08M15D 10h30m00s
EDIT: Push ENTER!
```

- 4) Press the [ENTER/YES] key again.

The clock data at the moment when pressing the key is hold and the "second" field flashes.

```
SYS▶ Adjust RTC
--- Adjust RTC ---
'04Y08M15D 10h30m00s
```

- 5) Enter date/time data.

Use the [MENU] dial (or the alphanumeric keys) to enter a desired value to the current cursor position (flashing field). You can move the cursor position using the [SKIP/CURSOR |◀▶|] keys.

- 6) After entering date/time data, press the [ENTER/YES] key.

The clock starts running from the entered date/time.

<Note>: We recommend entering a time shortly ahead of "now" (such as one minute ahead) in step 5 above and pressing the [ENTER] key (in step 6 above) at the moment when the current time reaches the entered time.

- 7) Press the [STOP/HOME] key to exit the MENU mode.

<Note>: The unit has an internal lithium battery which is used for driving the realtime clock. The battery life is approximately five years. The battery replacement is done by local Fostex distributor's service department or their authorized service agent.

About recommended disks

DVD-RAM disks used with the DV824

4.7GB Type 2 single-sided or 9.4GB Type 4 double-sided DVD-RAM disks can be used with the unit. When the unit is shipped, a 4.7GB Type 2 single-sided disk is supplied as standard.

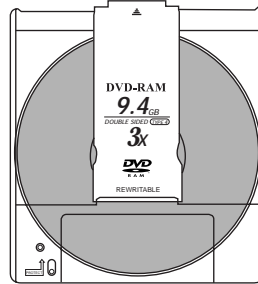
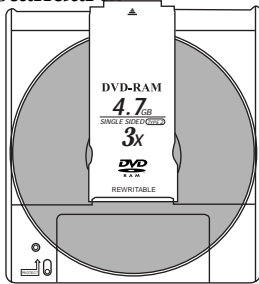

<Note>: Use only DVD-RAM disks recommended by Fostex.
For details about handling a disk, see the instructions of the disk.

<Note>: This unit also can use the optional hard disk drive as a recording/playback medium, as well as DVD-RAM disks.

By installing the optional hard disk drive, you can not only make recording to a hard disk partition in realtime, but also make file copy/disk copy between a DVD-RAM disk and a partition, etc. For details about the optional hard disk drive, contact your local Fostex distributor.

See "**Advanced operations**" on pages 83 ~ 91 for details about dual drive recording, file copy, disk copy, etc. which are possible by installing the optional hard disk drive.

Inserting/removing a disk

After turning on the power, pressing the [OPEN/CLOSE] key opens the disk tray. After placing a disk on the disk tray, pressing the [OPEN/CLOSE] key again closes the tray.

<Note>: When placing a disk on the tray, make sure that the recording side is down.

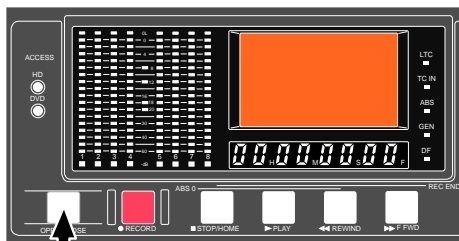

[OPEN/CLOSE] key

When loading the unused disk supplied with the unit, the disk is scanned and the display shows "Unformat!", followed by the second level screen of the "Format" menu item in the "DISK UTILITY" menu of the MENU mode. You can now execute the "initial formatting" by following the procedure described on page 20.

```
UTILITY>Format
Drive: DVD-RAM
Reel No: [S001
Format Mode: Normal
PhysicalFormat: Off
[EXECUTE]
(fmt time **h**m**s)
```

The DVD-RAM drive of the unit can load following types of disks. Depending on the type of a disk loaded, the unit starts up differently as described below. If you set a disk with the type other than the following types, the unit automatically rejects it and opens the disk tray.

- **Unformatted disk**

As described earlier, the unit recognizes that the disk is unformatted and shows "Unformat" on the display, followed by the "Format" menu item of the "DISK UTILITY" menu in the MENU mode.

- **Unused formatted disk**

If you set an unused UDF-formatted disk, the unit scans the disk and recognizes that no BWF files exist on the disk, then starts up while showing "--No files!--" on the Home screen (see page 21 for details).

- **Recorded disk**

If you set a DVD-RAM disk on which any audio file is recorded, the earliest recorded audio file (file number 001) on the disk is loaded normally. For example, if five recorded audio files (001 through 005) exist on the disk, the unit always starts up at the beginning (ABS 0) of the "001" file. However, if the "Resume" menu item of the "DISK UTILITY" menu in the MENU mode is set to "On", the audio file previously loaded before turning off the power last time is loaded (see page 154 for details).

- **CD-DA format audio CD**

If you set an audio CD disk of the Red Book format (regardless of whether it is a CD-R/RW disk or commercially available CD), the unit starts up at the beginning of track 1 (see page 64 for details). Only playback is possible with an audio CD.

Note that some copy-protected audio CDs may not be played back.

- **ISO9660-formatted CD-ROM, CD-R or CD-RW**

If you set an ISO9660-formatted CD-ROM, CD-R or CD-RW disk, you can play back a WAV file (BWF) on the disk.

Important notice for setting an uncovered disk to the tray

When you set an uncovered disk (such as a DVD-RAM disk which is taken out from a case, a CD-ROM or an audio CD), place the disk on the inner position of the tray and then slide it forward to fix it by the fixing guides on the tray, as shown in <Figure 1>. If you place a disk on the fixing guides and close the tray, the disk is not loaded correctly, which may damage the disk or the unit. Please make sure that an uncovered disk is correctly fixed by the fixing guides before closing the tray. When removing a disk from the tray, slide it backward and pull it up, as shown in <Figure 2>.

<Figure 1>

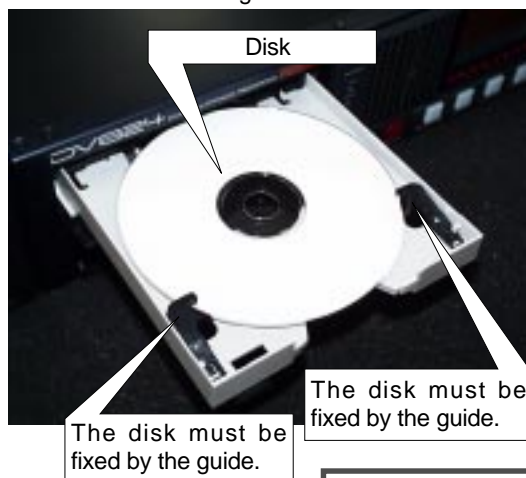

<Figure 2>



<Note>: The unit cannot make recording using an uncovered disk. An uncovered disk only can be played back.

Initial format of a DVD-RAM disk

To make recording/playback by the unit, you have to format a DVD-RAM disk in the UDF Rev 1.5 format.

When loading an unused DVD-RAM disk, the unit recognizes the disk is not formatted and automatically goes to the second level of the "Format" menu item.

On the "Format" second level screen, you can set the following four items before executing formatting.

```

UTILITY▶Format
Drive: DVD-RAM
Reel No: [S001
Format Mode: Normal
PhysicalFormat: Off
[EXECUTE]
(fmt time **h**m**s)
  
```

<The "Format" second level screen>

Drive	Selects a drive for formatting. If the optional hard disk drive is not installed, the internal DVD-RAM drive is the only option. If the optional hard disk drive is installed, you can select from among hard disk partitions (PT01 through PT08) and the internal DVD-RAM drive.
Reel No	Sets the reel number of a disk (or a partition of the optional hard disk drive) to be formatted. You can change the reel number after formatting, therefore, you do not have to change the default reel number here.
Format Mode	Selects a desired format mode. If the optional hard disk drive is not installed, "Normal" is the only option. If the optional hard disk drive is installed, you can select "DDR" for dual drive recording, as well as "Normal".
Physical Format	Selects whether or not physical-formatting a DVD-RAM disk (or a partition of the optional hard disk drive). This item is only valid for the "Normal" format mode. When setting this item to "Off", the unit executes the simple format and it takes very short time. When setting it to "On", it takes some time for formatting (see below).

<Note>: A reel number can be edited using the "Reel No" menu item in the "DISK UTILITY" menu. For details about reel number editing, see "Editing the reel number" on page 152.

<Note>: When formatting a well-used disk, execute the physical format. We also recommend executing the physical format for an unused disk if you have time. The following shows the appropriate required time for formatting a 4.7GB DVD-RAM disk (the required time according to the selection of the "Physical Format" item is shown on the screen).

When "Physical Format" is set to "Off": approx. 1 min. 30 sec.

When "Physical Format" is set to "On": approx. 1 hour 30 min.

<Note>: For details about dual drive recording, see "Advanced operations" on page 89.

The following description shows how to UDF-format an unused 4.7GB/Type2 DVD-RAM disk which is supplied with the unit, leaving the four items above as their default settings.

- 1) Use the [MENU] dial to select "[EXECUTE]" and press the [ENTER/YES] key. The display changes to show the warning message (i.e. all disk data are gone by formatting the disk) and flashing "Are you sure?".

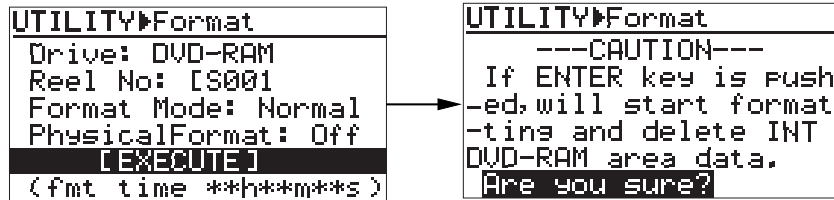

- 2) Press the [ENTER/YES] key again. The unit starts formatting the disk. The display shows the formatting countdown, as well as the progress status by the bar-graph meter. When formatting completes, the display shows "Fmt. Completed!" and the unit stops disk access.

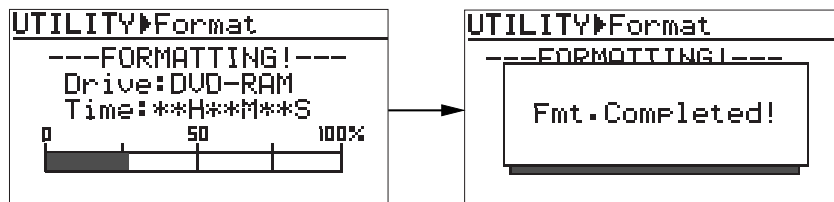

<Note>: Note that the formatting countdown and bar-graph meter show the approximate information. Do not proceed to the next step before "Fmt. Completed!" is shown.

- 3) Press the [EXIT/NO] key (or the [STOP/HOME] key) to exit the MENU mode. The display now shows the Home screen on which "-No files!-" is shown. Naturally, there is no files on a disk immediately after it is formatted.

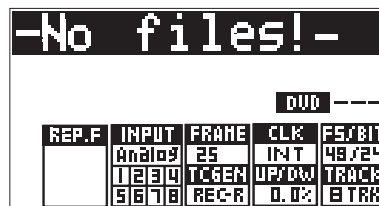

Now UDF-formatting of the supplied DVD-RAM disk completed and you can make recording and playback of the disk.

You can format a DVD-RAM disk you purchase in the same manner as above.

<Note>: To reformat a formatted DVD-RAM disk or to physically format a well-used disk, see "Formatting a disk" on page 149.

Adjusting display contrast

The display contrast of the unit is adjusted suitably when shipped. If you want to change the contrast, follow the procedure described below.

The following is assumed that the power of the unit is turned on and "--No disk--" is shown on the display.

- 1) Press the [SHIFT] key to turn on the [SHIFT] indicator, followed by the [TIME SEL/CONTRAST] key.

The popup message as shown below appears on the display and you can now adjust the display contrast.

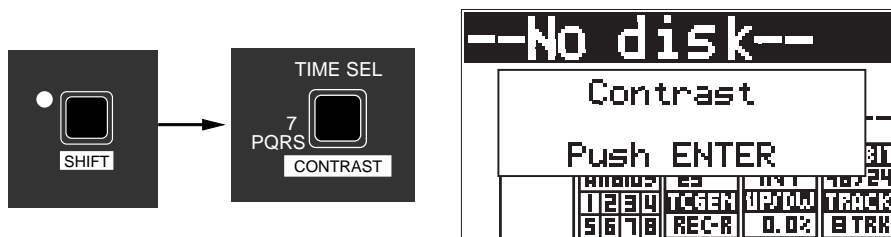

- 2) While the popup message above is shown, rotate the [MENU] dial to adjust the display contrast.
Rotating the dial clockwise weakens the contrast, while rotating it counterclockwise strengthens the contrast.
- 3) After adjusting the contrast, press the [ENTER/YES] key to confirm your setting.
The adjusted display contrast is now effective and the popup message above is dismissed.

<Note> The contrast adjustment screen can be dismissed by pressing the [ENTER/YES] key.

Chapter-3: Names and functions

Front panel

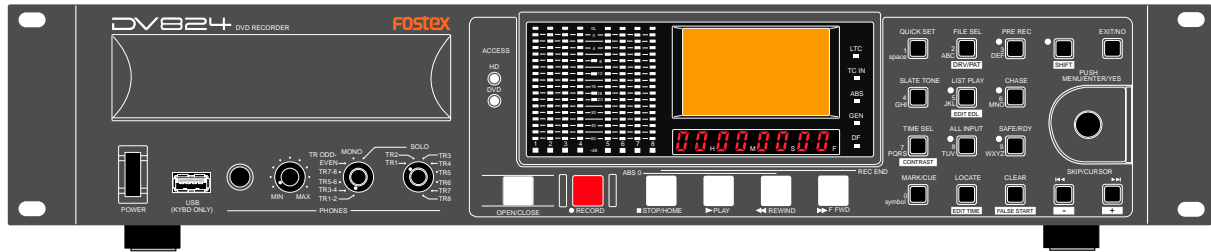

Rear panel

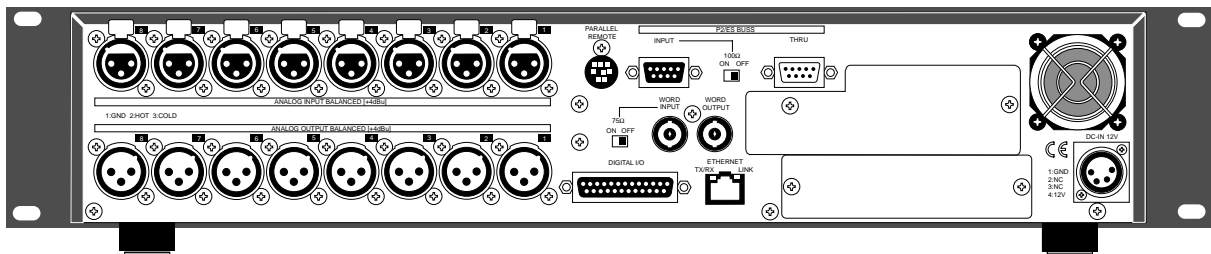
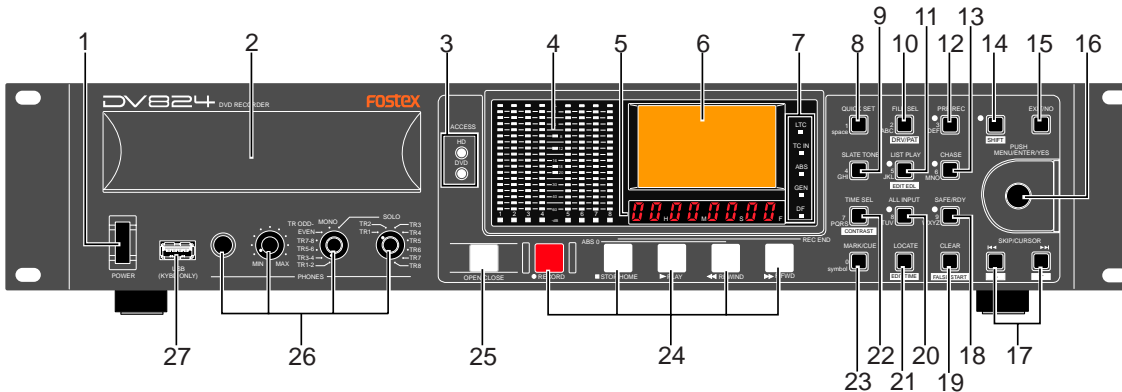

Table of contents

Front panel	24
Rear panel	30
Display	33
Home screen	33
File name	33
Next file name	33
Disk remaining	33
File number	33
File/disk/partition protection	33
Status information	34
Screen examples	35
7-segment LED time indicator	36

Front panel





About Non-shift mode and Shift mode

*Some keys have the secondary function which is available when the SHIFT indicator is lit (i.e. in the Shift mode), while the primary function is available when the SHIFT indicator is unlit (i.e. in the Non-shift mode).

In this manual, we sometimes say "when SHIFTed" and "when unSHIFTed", instead of "when the SHIFT indicator is lit" (or "in the Shift mode") and "when the SHIFT indicator is unlit" (or "in the Non-shift mode") respectively.

- 1) **[POWER] switch**
Turns on or off the power of the unit.
- 2) **Disk tray**
Loads a DVD-RAM disk. Use the [OPEN/CLOSE] key to open or close the tray.
See page 18 for details about DVD-RAM disks which can be used with the unit.
- 3) **[ACCESS] indicators**
Indicates the condition of the current (currently selected) drive.
When the DVD-RAM drive is selected, "**DVD**" indicator is lit. When any partition of the optional hard disk drive is selected, "**HD**" indicator is lit. When the optional hard disk drive is installed and file copy or disk copy between drives is being executed, both the indicators are lit.
Depending on the drive condition, the color of the indicator changes as below.
 - Lit in green: The drive is selected as the recording medium.
 - Lit in orange: Now reading data.
 - Lit in red: Now writing data.
- 4) **Level meters**
Show the recording/playback level of tracks 1 through 8.
- 5) **7-segment time display**
Shows time data in the currently selected time mode. You can select the time mode using the [TIME SEL/[CONTRAST]] key (**See page 51 for details**).

- 6) **LCD display**
Shows audio file information, menu setting screens, etc. (see page 33 for details).
- 7) **Time mode indicators**
The indicator of the current time mode is lit.
- 8) **[QUICK SET/1, Space] key**
Pressing this key enters the quick setup mode. In this mode, you can directly select the setting items (INPUT, FRAME, CLK, FS/BIT, TC GEN, UP/DW and TRACK) shown on the Home screen (see page 44 for details).
If SAFE/RDY is set to ON, you can also edit the NEXT file name.
When the display shows a screen for alphanumerical character entry, this key is used for entering "1" or "Space".
- 9) **[SLATE TONE/4, G, H, I] key**
Pressing this key outputs the 1-kHz slate tone at the reference level.
During recording, you can also record the slate tone (see page 55 for details).
When the display shows a screen for alphanumerical character entry, this key is used for entering "4", "G (g)", "H (h)" or "I (i)".
- 10) **[FILE SEL/2, A, B, C/ ] key**
This key has primary (unSHIFTed) and secondary (SHIFTed) functions.
When unSHIFTed:
Pressing this key brings up the "FILE SEL" menu item of the MENU mode. This menu item allows you to select a desired audio file for playback. Use the [MENU] dial for selecting a file and press the [ENTER/YES] key to confirm your setting.
When the display shows a screen for alphanumerical character entry, this key is used for entering "2", "A (a)", "B (b)" or "C (c)".
When SHIFTed:
Pressing this key brings up the "DRIVE SEL" menu item of the MENU mode. This menu item allows you to select the recording medium (the DVD-RAM drive or any partition of the optional hard disk drive). Use the [MENU] dial for selecting a desired medium and press the [ENTER/YES] key to confirm your setting.
- 11) **[LIST PLAY/5, J, K, L/ ] key**
This key has primary (unSHIFTed) and secondary (SHIFTed) functions.
When unSHIFTed:
Pressing this key turns on or off the List play mode. When turning on the List play mode, the display shows the screen for selecting the list files. You can also select the track mode and link mode for the List play (see page 66 for details).
When the display shows a screen for alphanumerical character entry, this key is used for entering "5", "J (j)", "K (k)" or "L (l)".
When SHIFTed:
Pressing this key brings up the "EDIT EDL FILE" menu item of the MENU mode. This menu item allows you to create or edit the ALE file for exporting recorded audio files to the AVID system (see page 99 for details).

12) [PRE REC/3, D, E, F] key

Pressing this key turns on or off the Pre rec mode.

While the Pre rec mode is on, the indicator lights and you can start recording from the audio data stored in the buffer (see page 54 for details).

When the display shows a screen for alphanumerical character entry, this key is used for entering "3", "D (d)", "E (e)" or "F (f)".

13) [CHASE/6, M, N, O] key

Pressing this key turns on or off the Chase mode (see page 92 for details). While the Chase mode is on and the unit is chasing the master, the indicator flashes if chase-lock is not achieved, or lights if chase-lock is achieved.

When the display shows a screen for alphanumerical character entry, this key is used for entering "6", "M (m)", "N (n)" or "O (o)".

14) [SHIFT] key

Pressing this key turns the shift mode on or on. When on, the indicator is lit and you can execute a SHIFTEd (secondary) function of a key which has dual functions. The SHIFTEd function of a key (if available) is labeled under the key.

15) [EXIT/NO] key

This key has opposite functions to the [ENTER/YES] key. It is used to cancel editing or execution.

16) [MENU] dial/[ENTER/YES] key

This knob has dual functions; the [MENU] dial for selecting an option and the [ENTER/YES] key for confirming the selection.

Pressing the [ENTER/YES] key enters the MENU mode. In the MENU mode, you can use the [MENU] dial to make settings of each menu item of the MENU mode. The [MENU] dial also can be used for entering alphanumerical characters.

17) [SKIP/CURSOR |◀◀, ▶▶|] keys

These keys have primary (unSHIFTEd) and secondary (SHIFTEd) functions.

When unSHIFTEd:

Depending on "Skip mode" setting of the "SYS SETUP" menu item of the MENU mode, the keys have different functions.

When the skip mode is set to "File" (by default):

Pressing the [◀◀] or [▶▶] key skips to the beginning of the previous or next audio file (ABS 0). You can skip to the beginning of a desired file by pressing the key as many times as required.

When the skip mode is set to "Cue":

Pressing the [◀◀] or [▶▶] key skips to the previous or next cue point in the current audio file. You can skip to the desired cue point by pressing the key as many times as required.

When the display shows a screen for entering alphanumerical characters, these keys can be used for moving the cursor position.

When SHIFTEd:

When the display shows a screen for entering time or numerical value with a plus or minus sign, the [◀◀] and [▶▶] keys can be used for entering a minus ("-") and plus ("+") sign respectively.

18) [SAFE/RDY/9, W, X, Y, Z] key

Pressing this key switches the unit between the “record safe” and “record ready” modes. When recording status, a new audio file is created and the unit records an audio signal from the beginning of the file (ABS 0). The indicator flashes in the record ready mode, while it lights during recording (**see page 52 for details**). When the display shows a screen for alphanumerical character entry, this key is used for entering "9", "W (w)", "X (x)", "Y (y)" or "Z (z)".

19) [CLEAR/FALSE START] key

This key has primary (unSHIFTed) and secondary (SHIFTed) functions.

When unSHIFTed:

Pressing this key clears hold data of the level meters.

When the display shows a screen for alphanumerical character entry, this key clears whole data.

When SHIFTed:

Pressing this key after making recording cancels the recording. It is useful when recording has been unsuccessfully made. When the recording is canceled, the file name is reused and the remaining time returns to the previous value (**see page 54 for details**).

20) [ALL INPUT/8, T, U, V] key

Pressing this key turn on or off the “All input monitor” mode. Depending on the All input monitor status, the indicator is lit (when “on”) or unlit (when “off”). When the Auto EE mode is on, the All input monitor status automatically switches between on and off depending on the unit status. You can set the Auto EE mode on/off via the “Auto EE mode” menu item of the “SYS SETUP” menu in the MENU mode (**see page 121 for details**).

When the display shows a screen for alphanumerical character entry, this key is used for entering "8", "T (t)", "U (u)" or "V (v)".

21) [LOCATE/EDIT TIME] key

This key has primary (unSHIFTed) and secondary (SHIFTed) functions.

When unSHIFTed:

Pressing this key relocates the recorder to the position previously located (if the recorder has not located to any position before, it locates to "ABS 0").

When the display shows a screen for selecting a cue point, pressing this key after selecting a desired cue point locates the recorder to the selected cue point (**see page 61 for details**).

When SHIFTed:

Pressing this key brings up the TIME EDIT screen and you can edit the current time. After then, pressing this key locates the recorder to the edited time position (**see page 61 for details**).

22) [TIME SEL/7, P, Q, R, S/CONTRAST] key

This key has primary (unSHIFTed) and secondary (SHIFTed) functions.

When unSHIFTed:

Pressing this key changes the time mode on the display among "ABS", "TC IN", "GEN" and "LTC" in that order (**see page 51 for details**).

When the display shows a screen for alphanumerical character entry, this key is used for entering "7", "P (p)", "Q (q)", "R (r)" or "S (s)".

When SHIFTed:

Pressing this key enters the contrast adjustment mode and you can adjust the display contrast (**see page 22 for details**).

23) [MARK/CUE/0, symbol] key

Pressing this key during recording marks a cue on-the-fly (**see page 56 for details**).

While the unit is not recording, pressing this key brings up the "CUE LIST" menu screen and you can edit time data and cue label of a cue point.

When the display shows a screen for alphanumerical character entry, this key is used for entering "0" or any symbol.

24) Transport control keys**[▶ PLAY] key**

Pressing this key plays back the current drive (DVD-RAM drive or a partition of the optional hard disk drive).

<Note>: *While the reference clock ("CLK" item) is set to "DIGI" or "WORD", if the FS of the playback file does not match the FS of the unit, playback is not correctly done. In such a case, make the FS of the unit match the FS of the playback file.*

[■ STOP/HOME] key

- Pressing this key stops recording/playback of the current drive. If you press this key during recording with the Pre rec mode set to "ON", the unit stops recording after "post recording" is took place.
- If the DVD-RAM drive is selected as the current drive and the disk tray is open, pressing this key closes the tray (i.e. acts the same as pressing the [OPEN/CLOSE] key).
- Pressing this key exits any editing or setting mode and returns to show the Home screen.
- Pressing the [F FWD] or [REWIND] key while holding down this key locates to a specific position as below.

[STOP] + [F FWD]: Locates to the last recording position (REC END) of the current audio file.

[STOP] + [REWIND]: Locates to the beginning (ABS 0) of the current audio file.

[◀◀ REWIND] key

- Pressing this key while stopped starts fast-rewind at up to 30 times the normal playback speed.
- Pressing this key during playback executes cueing playback.
- While stopped, pressing this key while holding down the [STOP] key locates to the beginning (ABS 0) of the current audio file.

<Note>: *The maximum cueing speed depends on the FS and the number of tracks of a file.*

[▶▶ F FWD] key

- Pressing this key while stopped starts fast-forward at up to 30 times the normal playback speed.
- Pressing this key during playback executes cueing playback.

- While stopped, pressing this key while holding down the [STOP] key locates to the last recording position (REC END) of the current audio file.

<Note>: *The maximum cueing speed depends on the FS and the number of tracks of a file.*

[RECORD] key

- While the [SAFE/READY] indicator is lit, pressing this key automatically creates a new file and starts recording (**see page 52 for details**).
If the optional TC/SYNC card is installed, a time code can be striped together with audio signals, according to the setting of the "Gen Mode" menu item of the "TC SETUP" menu in the MENU mode (**see page 80 for details**).
- If the Pre rec mode is set to "ON", pressing this key starts recording from the audio data stored in the buffer (**see page 54 for details**).

<Note>: *If record-protection is set to on, pressing this key brings up the warning message, while the unit does not start recording.*

25) [OPEN/CLOSE] key

Pressing this key opens or closes the disk tray.

When a disk is loaded, the unit responds differently depending on the disk, as described below.

Unused formatted disk:

The display shows "-No files!-".

Recorded disk:

Normally, the recorder locates to the beginning (ABS 0) of "PGM1" (the earliest recorded audio file on the disk).

Note that, however, if the "Resume" menu item of the "DISC UTILITY" menu in the MENU mode is set to "ON" and the resume file is correctly set, the recorder locates to the beginning of the resume file (**see page 154 for details**).

Unformatted disk:

The unit recognizes that the loaded disk is unformatted and automatically brings up the "Format" menu item of the "DISC UTILITY" menu in the MENU mode (**see page 20 for details**).

26) [PHONES] section

The versatile [PHONES] section allows you to monitor in various combinations of tracks, including mono mix, stereo mix, stereo pair tracks and a solo track (**see page 51 for details**).

27) [USB (KYBD ONLY)] port

This port is used for connecting to a USB keyboard (**see page 41 for details**).

According to the connected keyboard, set the "keyboard type" menu item in the "SYS SETUP" menu of the MENU mode appropriately (**see page 123 for details**).

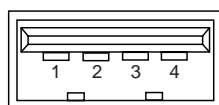

1	VBUS
2	D-
3	D+
4	GND

Rear panel

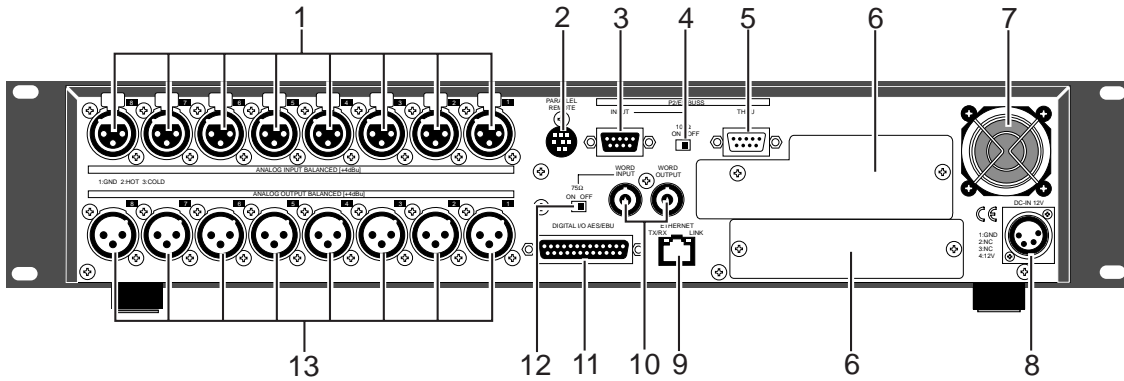

1) [ANALOG INPUT BALANCED] connectors

These XLR-3-31 type balanced connectors receive analog audio signals for channels 1 through 8 (+4dBu).

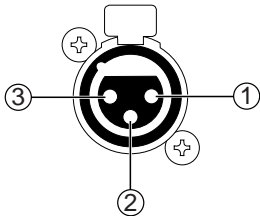

1	GND
2	HOT
3	COLD

2) [PARALLEL REMOTE] connector

This mini DIN 8-pin connector is used for controlling the unit externally.

You can execute the following transport controls/functions remotely via this connector.

1	PLAY	4	REWIND	7	PAUSE
2	STOP	5	FAST FORWARD	8	SKIP/CURSOR I◀◀
3	RECORD	6	CUE point mark	9	SKIP/CURSOR ▶▶I

<Pin assignments>

Each transport control/function gets active by grounding the associated pin.

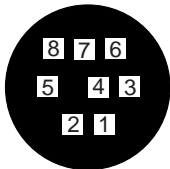

1	PLAY
2	STOP
3	REC
4	GND
5	SHIFT
6	REW
7	VBATT*
8	FF

SHIFT+STOP	CUE
SHIFT+REC	PAUSE
SHIFT+REW	SKIP/CURSOR I◀◀
SHIFT+FF	SKIP/CURSOR ▶▶I

(*) VDD (12V), Max 500mA

The power voltage is supplied while the unit's power is on.

<Note>: Pin 7 (DC-12V) derives from the internal main power supply of the unit. If you short-circuit it to ground or connect it to heavy load, the unit may heat up abnormally. When using the [PARALLEL REMOTE] connector, connect to lighter load and never short-circuit the pin.

3) [P2/ES BUSS/INPUT] connector

This connector is used for controlling the unit from an external video editor, etc. The hardware specification is conformed to RS-422A. The connector type is D-sub 9-pin, female.

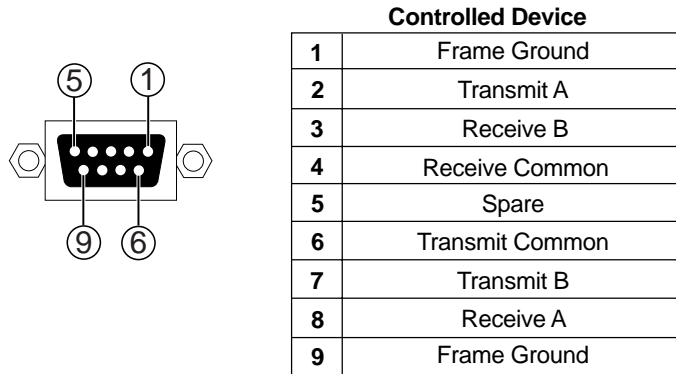

*Protocol: conformed to the Sony 9-pin protocol

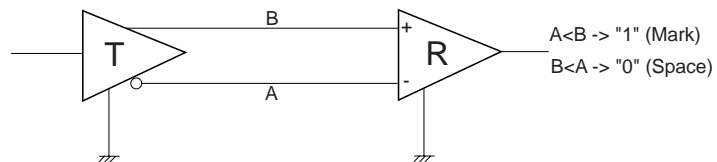

4) Terminate switch (100Ω, ON/OFF)

To terminate the [P2/ES BUSS/INPUT] connector, set this switch to ON.

5) [P2/ES BUSS/THRU] connector

This connector echoes the control signal received at the [P2/ES BUSS INPUT] connector. See "[P2/ES BUSS INPUT] connector" above for the pin assignment. The connector type is D-sub 9-pin, female.

6) Blank panels

When installing the optional TC/SYNC card and IEEE1394/USB card, remove these panels.

7) Cooling fan

This fan ventilates the DV824. If the ventilation is disturbed, the DV824 may overheat. Therefore, do not block the vent of the cooling fan.

8) [DC IN 12V] connector

This connector is used to connect to the supplied AC adaptor (Model AD-15C). The connector type is XLR-4-32.

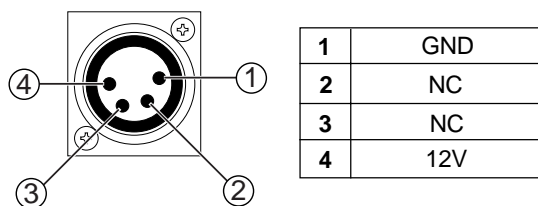

9) [ETHERNET] port

This port is used to connect to the Ether network.

The connector type is RJ45 (conformed to 100/10BASE-T FTP).

The LINK and TX/RX indicators light in the following conditions.

- The LINK indicator lights when the unit recognizes the network.
- The TX/RX indicator flashes when the unit is sending or receiving data.

10) [WORD IN]/[WORD OUT] connector

The [WORD IN] connector receives a word clock signal.

The [WORD OUT] connector feeds word clock signal.

The connector type is BNC.

11) [DIGITAL I/O AES/EBU] connector

This connector inputs and outputs AES/EBU or S/P DIF digital signals.

You can set the digital input channel by the "Setup Digital In" menu item of the "SYS SETUP" menu in the MENU mode (see page 119 for details).

The unit automatically detects the digital input signal format.

The digital output signal format can be set by the "Digital out" menu item of the "SYS SETUP" menu in the MENU mode (see page 120 for details).

The connector type is D-sub 25-pin.

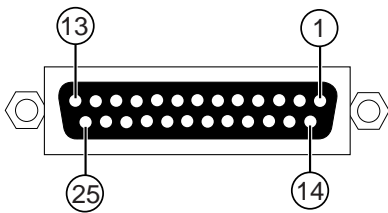

Signal	Hot	Cold
Input 1/2	1	14
Input 3/4	2	15
Input 5/6	3	16
Input 7/8	4	17
Output 1/2	5	18
Output 3/4	6	19
Output 5/6	7	20
Output 7/8	8	21
Frame GND	10, 12, 13, 22, 23 24, 25	
Open	9, 11	

* The connector pin assignment is compatible with the D-sub 25-pin connectors on YAMAHA equipment.

12) [WORD IN] terminate switch

Terminates the word input signal by setting the switch to "ON".

13) [ANALOG OUTPUT BALANCED] connectors

These connectors output analog audio signals of tracks 1 through 8.

The connector type is XLR-3-32 (balanced/+4dBu).

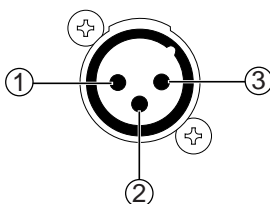

1	GND
2	HOT
3	COLD

Display

Home screen

The Home screen is shown after turning on the unit, or during recording or playback. The screen example below shows the Home screen when a DVD-RAM disk is set to the DVD-RAM drive. On the Home screen, various information about the current setting and status is shown, as described below.

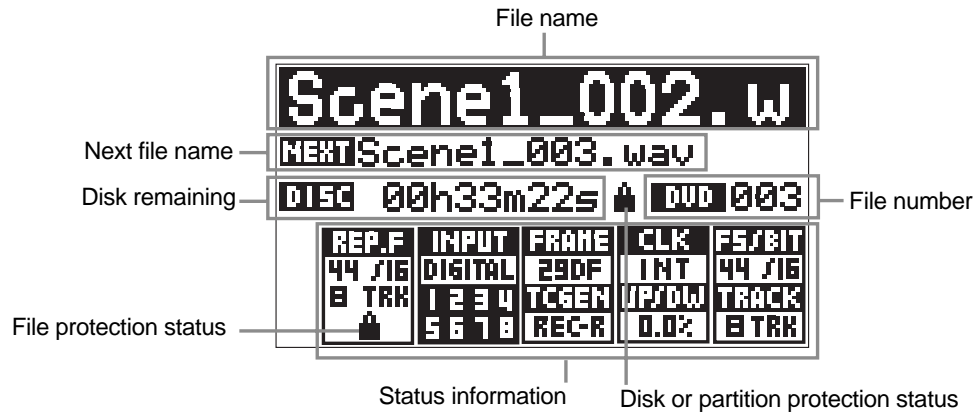

File name

Shows the name of the audio file currently loaded or being recorded.

If no file exists on the current disk (or partition when optional hard disk drive is installed), "**-No Files!**" is shown. If no disk is set to the DVD-RAM drive, "**--No disk--**" is shown.

Next file name

Shows the name of the audio file for the next recording. The next file name is shown only when the [SAFE/RDY] indicator is lit (i.e. the unit is in the rec ready or record mode). Depending on the setting of the "Default file name" menu item of the "SYS SETUP" menu in the MENU mode, the name type differs as below.

When "Default file name" is set to "Date"	"<DATE>" is shown.
When "Default file name" is set to "Take"	"Scene + Take number" is shown.

You can change the next file name via the quick setup mode ([see page 49](#)) or the "Default file name" menu item of the "SYS SETUP" menu ([see page 115](#)).

Disk remaining

When the unit is in the record ready mode, the remaining recordable time of the disk is shown. During recording, the remaining recordable time of the current file is shown. The remaining recordable time of the file is calculated based on the "Max file length" setting (the default is 4 GB) in the "SYS SETUP" menu of the MENU mode. If the remaining space of the disk is smaller than the "Max file length", the recording time is calculated based on the disk remaining space (see page 118).

File number

The file number of the currently loaded audio file is shown in three digits.







If no file exists on the DVD-RAM disk (or the selected partition on the optional hard disk), "🔒" is shown.

File/disk/partition protection

If the current audio file or the current disk (or hard disk partition) is protected, the "🔒" icon is shown. When the current audio file is protected, the "🔒" icon is shown on left bottom of the status information section. When the current disk (or partition) is protected, the "🔒" icon is shown on the right of the disk remaining information.

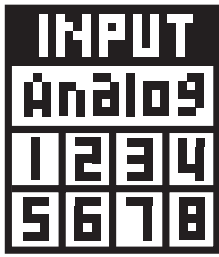
Status information

The current settings of menu items are shown.

	<p>The current clock reference setting is shown (the default is "INT"). You can set the clock reference via the quick setup mode (see page 47) or the "Sync Clock" menu item of the "TC SETUP" menu (see page 127). If the optional TC/SYNC card is installed and the unit does not lock to the external clock reference, the selected option flashes quickly.</p>
	<p>The current time code frame rate setting is shown (the default is "25"). You can set the time code frame rate via the quick setup mode (see page 46) or the "Frame rate" menu item of the "TC SETUP" menu (see page 127).</p>
	<p>The current FS and bit length setting is shown (the default is "48/24"). You can set the FS and bit length via the quick setup mode (see page 47) or the "Record FS&Bit" menu item of the "SYS SETUP" menu (see page 117).</p>
	<p>The current input mode setting is shown (the default is "Analog"). You can set the input mode via the quick setup mode (see page 45) or the "Select Input" menu item of the "SYS SETUP" menu (see page 119). If the input mode is set to "DIGITAL", the currently locked channel(s) (1 through 8) is (are) shown. If no channel is shown even though the input mode is set to "DIGITAL", the analog input is selected.</p>
	<p>The FS, bit length and track mode of the audio file currently being played back are shown. While playing back an audio file, the actual FS, bit length and track mode of the audio file take priority to the associated menu item settings. If the current audio file is protected, the "🔒" icon is shown (for details about how to release the protection, see page 153).</p>
	<p>The current time code recording mode is shown (the default is "Run"). You can set the time code recording mode via the quick setup mode (see page 47) or the "Gen mode" menu item of the "TC SETUP" menu (see page 128).</p>
	<p>The current pull up/down setting is shown (the default is "0.0%"). You can make the pull up/down setting via the quick setup mode (see page 48) or the "Pull Up/Down" menu item of the "SYS SETUP" menu (see page 118).</p>
	<p>The current setting of the number of recording tracks is shown (the default is "8 TRK"). You can make the pull up/down setting via the quick setup mode (see page 48) or the "Record Tracks" menu item of the "SYS SETUP" menu (see page 117).</p>

Screen examples

When no disk is set to the DVD-RAM drive

When no disk is set to the DVD-RAM drive, "--No disk--" is shown in the "File name" area on the Home screen.

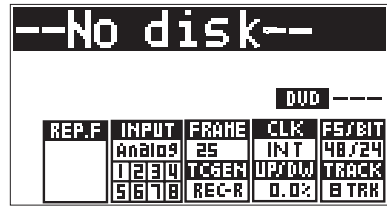

When a formatted unused disk is set to the DVD-RAM drive

When formatted unused DVD-RAM disk is loaded, "-No files!" is shown in the "File name" area on the Home screen.

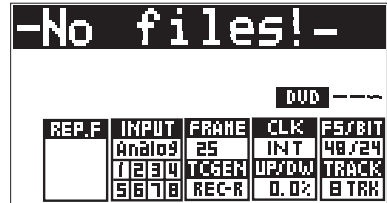

When a recorded disk is set

When a recorded DVD-RAM disk is loaded, a file name is shown in the "File name" area on the Home screen.

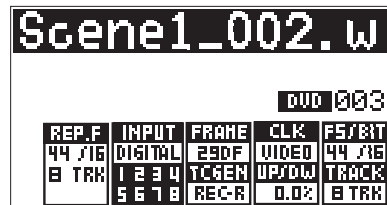

MENU list screen

The MENU list screen is shown when pressing the [ENTER/YES] key while the unit is stopped. This screen is the first level screen of the MENU mode and you can select a desired menu from 11 menus listed on this screen using the [MENU] dial.

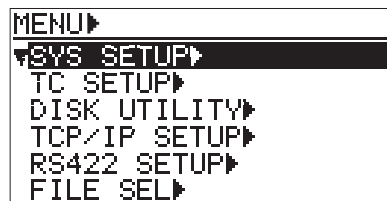

SYS SETUP menu screen

This menu screen is shown when selecting "SYS SETUP" from the MENU list screen and pressing the [ENTER/YES] key. 23 menu items are available in the "SYS SETUP" menu.

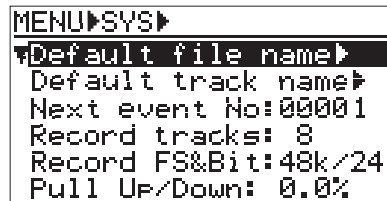

DISK UTILITY menu screen

This menu screen is shown when selecting "DISK UTILITY" from the MENU list screen and pressing the [ENTER/YES] key. Twelve menu items regarding disk settings are available in the "DISK UTILITY" menu.



TC SETUP menu screen

This menu screen is shown when selecting "TC SETUP" from the MENU list screen and pressing the [ENTER/YES] key. Sixteen menu items regarding time code recording/playback, synchronization to an external device, etc. are available in the "TC SETUP" menu.

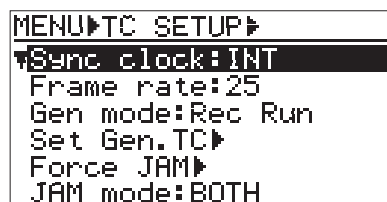

TCP/IP SETUP menu screen

This menu screen is shown when selecting "TCP/IP SETUP" from the MENU list screen in the MENU mode and pressing the [ENTER/YES] key.

Six menu items regarding TCP/IP settings for using the unit in the Ethernet are available in the "TCP/IP SETUP" menu.

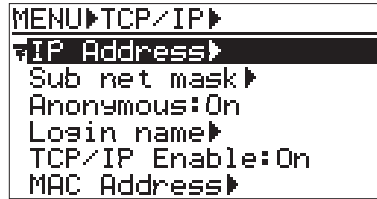

RS422 SETUP menu screen

This menu screen is shown when selecting "RS422 SETUP" from the MENU list screen in the MENU mode and pressing the [ENTER/YES] key.

Four menu items regarding RS422 settings for controlling the unit from an external editor, etc. are available in the "TCP/IP SETUP" menu.

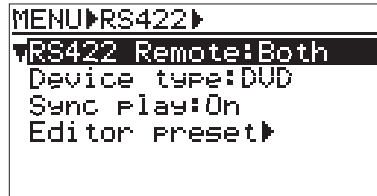

EDIT EDL FILE menu screen

This menu screen is shown when selecting "EDIT EDL FILE" from the MENU list screen in the MENU mode and pressing the [ENTER/YES] key.

From the EDIT EDL FILE menu, you can create an ALE file for exporting recorded audio files to the AVID system.



Popup windows

A popup window appears over the Home screen as below and shows the current status of the unit. In the example below, the popup shows that the unit is now in the display contrast adjustment mode (this popup can be brought up by pressing the [TIME SEL] key when SHIFTed).

In this condition, rotating the [MENU] dial controls the display contrast and pressing the [ENTER/YES] key confirms the setting.



7-segment LED time indicator

In the 7-segment LED time indicator, the ABS time, LTC (of the internal time code generator) or external time code is shown in realtime. You can select the time mode using the [TIME SEL/CONTRAST] key.



Chapter-4: Connection

Table of contents

Basic connection	38
Analog audio input connection	38
Digital audio input connection	38
External parallel controller connection	39
External video editor connection	39
Sync signal (word clock) connection	39
Ethernet connection	39
Connection for optional cards	40
Time code input/output connection (for the optional TC/SYNC card)	40
Connection to a film machine (for the optional TC/SYNC card)	40
Connection to a personal computer (for the optional IEEE1394/USB card)	40
Other connection	41
USB keyboard connection	41

Basic connection

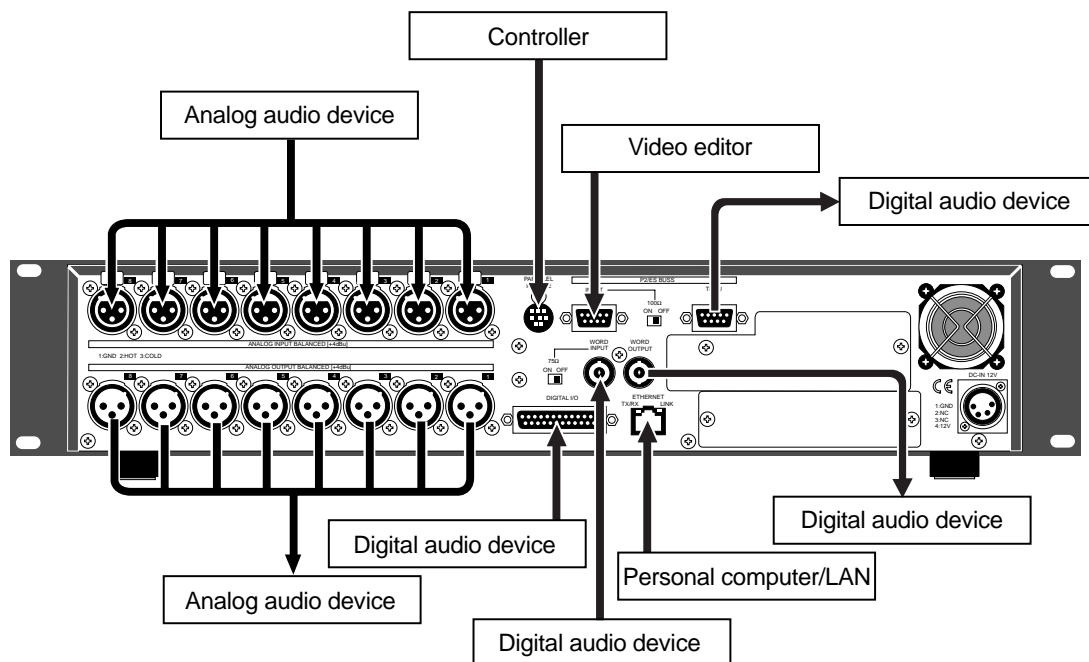

Analog audio connection

The DV824 provides eight balanced XLR-3-31-type [ANALOG INPUT] connectors which accept +4 dBu analog audio signals.

The number of recording tracks can be set using the "Record Tracks" menu item of the "SYS SETUP" menu in the MENU mode (see pages 48 and 117 respectively). The available options are 1 (mono), 2, 4, 5, 6 and 8 (the default is "8").

The DV824 also provides eight balanced XLR-3-32-type [ANALOG OUTPUT] connectors which output +4 dBu analog audio signals.

Digital audio connection

The DV824 accepts digital signals conformed to IEC 60958 (AES/EBU) or IEC 60958 (S/P DIF) format (the format of the digital source is automatically detected). The digital connection is made via the D-sub 25-pin DIGITAL I/O connector.

To record a digital audio source, connect a digital source to the [DIGITAL I/O] connector, and set the "Select Input" and "Setup digital in" menu items of the "SYS SETUP" menu in the MENU mode appropriately.

"Select Input" must be set to "Digital" (the default is "Analog"), while "Setup digital in" should be set appropriately depending on the situation (see pages 45 and 119 respectively). The latter can be set in pair channels and the default settings of four pairs are all "Digital".

When the DV824 receives a digital source from the selected channels, PLL (Phased-locked loop) activates and locks to the input sync signal.

The DV824 also outputs digital signals conformed to IEC 60958 (AES/EBU) or IEC 60958 (S/P DIF) format. The format of the digital output signal can be selected using the "Digital out" menu item of the "SYS SETUP" menu in the MENU mode (the default is "ABS/EBU"). (See page 120 for details.)

<Note>: The FS of the receiving digital input signal must match the FS setting of the unit. You can make the FS setting using the "Record FS/BIT" menu item of the "SYS SETUP" menu in the MENU mode or the quick setup mode (see pages 47 and 117 respectively).

External parallel controller connection

The DV824 provides the [PARALLEL REMOTE] connector (8-pin mini DIN), which is used for connecting to an external controller. You can operate the following nine functions using the external controller.

1	PLAY	4	REWIND	7	PAUSE
2	STOP	5	F. FORWARD	8	SKIP/CURSOR ◀◀
3	RECORD	6	CUE point entry	9	SKIP/CURSOR ▶▶

<Pin assignment>

Each transport control/function gets active by grounding the associated pin.

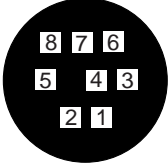
	1	PLAY	SHIFT+STOP	CUE
	2	STOP	SHIFT+REC	PAUSE
	3	REC	SHIFT+REW	SKIP/CURSOR ◀◀
	4	GND	SHIFT+FF	SKIP/CURSOR ▶▶
	5	SHIFT		
	6	REW		
	7	VBATT*		
	8	FF		

(*) VDD (12V), Max. 500mA

The power voltage is supplied while the unit's power is on.

<Note>: Pin 7 (DC-12V) derives from the internal main power supply of the unit. If you short-circuit it to ground or connect it to heavy load, the unit may heat up abnormally. When using the [PARALLEL REMOTE] connector, connect to lighter load and never short-circuit the pin.

External video editor connection

Using the [P2/ES BUSS INPUT] connector, you can control the DV824 from an external video editor via RS422. The [P2/ES BUSS THRU] connector allows you to control more than one unit from the editor (see page 71 for details).

Sync signal (word clock) connection

The DV824 provides the [WORD INPUT] connector which is used to lock the DV824 to an external digital device. The connector accepts a word clock from an external device.

The DV824 also provides the [WORD OUTPUT] connector which feeds a word clock to an external device.

Ethernet connection

The DV824 is equipped with the ether card and provides the RJ-45 connector which supports 100/10BASE-T FTP.

By connecting the unit to your PC via a LAN cable and setting up the unit as an "FTP (File Transfer Protocol) server, you can transfer audio files between the unit and PC over TCP/IP. An appropriate FTP client application is used for file data transfer (see page 73 for details).

Connection for optional cards

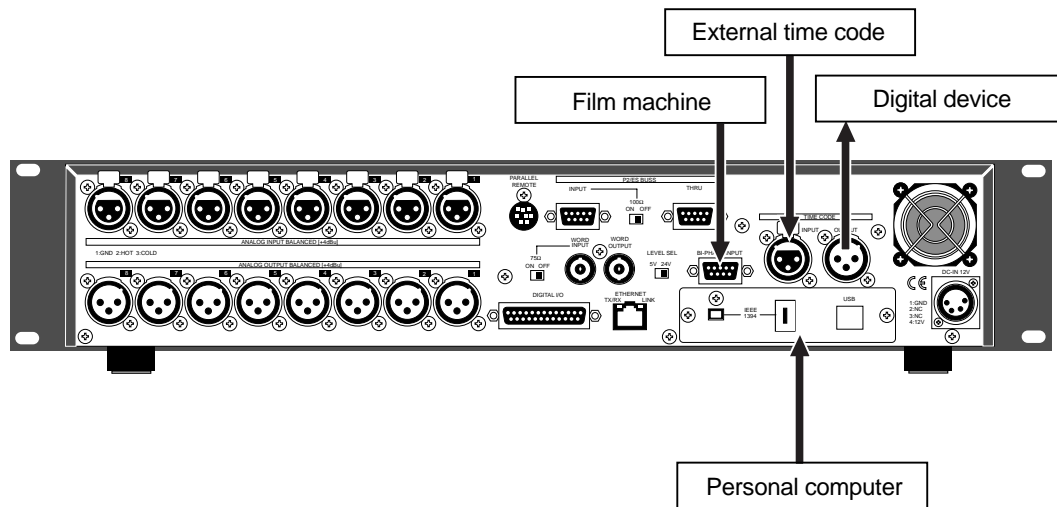

Time code input/output connection (for the optional TC/SYNC card)

By installing the optional TC/SYNC card (Model 8348), you can stripe time code generated by the TC generator on the card or external time code (SMPTE/EBU) received from the [TIME CODE INPUT] connector, together with audio signals. The [TIME CODE INPUT] connector is XLR-3-31-type (pin 2=hot).

To stripe external time code, set the "Gen mode" menu item of the "TC SETUP" menu in the MENU mode or quick setup mode to "Ext Run" (**see page 47 and 128 respectively**).

While the unit is receiving valid time code via the [TIME CODE INPUT] connector, you can check the current time and frame rate of the incoming time code by selecting the time mode on the display to "TC IN". The unit recognizes incoming time code as "valid" when the time code satisfies the following conditions.

- 1) The time code runs forward continuously.
- 2) The sync clock and frame rate of the time code match the DV824 setting.
- 3) The time code has very few dropouts.

The [TIME CODE OUTPUT] connector outputs SMPTE/EBU time code. The connector is XLR-3-32 type (pin 2=hot). It can output time code recorded on a disk (REPRO TC) or time code generated by the time code generator on the optional TC/SYNC card (INT GEN TC), which can be selected using the "Sel. TC Out" menu item of the "TC SETUP" menu in the MENU mode (**see page 131 for details**).

Connection to a film machine (for the optional TC/SYNC card)

The optional TC/SYNC card provides the [BI-PHASE INPUT] connector, which receives a bi-phase signal for synchronizing the unit to a film machine. To synchronize the unit to a film machine, set the "BiPhase Setup" menu item of the "TC SETUP" menu in the MENU mode appropriately (**see page 138 for details**).

A D-sub, 5-pin type connector with a built-in photo-coupler is used for the [BI-PHASE INPUT] connector. It accepts a TTL level signal.

Connection to a personal computer (for the optional IEEE1394/USB card)

By fitting the optional IEEE1394/USB card and installing the driver supplied with the card (or commercially available DVD writing software application) to your PC, you can transfer audio files between the DV824 and PC (**see page 93 for details**).

The IEEE1394/USB card provides a pair of the [IEEE1394] ports conformed to P1394a Draft2.0, as well as the [USB] port which is "USB Series B Receptacle".

Other connection

USB keyboard connection

The DV824 provides the [USB] port on the front panel, which is dedicated to a USB keyboard. By connecting a USB keyboard to this connector, you can enter file and label names, as well as carry out some of menu operations, from the keyboard.

- <Notes>**
- To control the DV824 from the USB keyboard, make setting of the "Keyboard Type" menu item of the "SYS SETUP" menu in the MENU mode appropriately ("US" or "JAPAN") according to the keyboard connected (see page 123 for details).
 - With some keyboard, indicators may not light until pressing any key after connection is made.
 - We cannot guarantee to work correctly if you use a keyboard with built-in a USB hub, USB mouse or PS2 mouse.

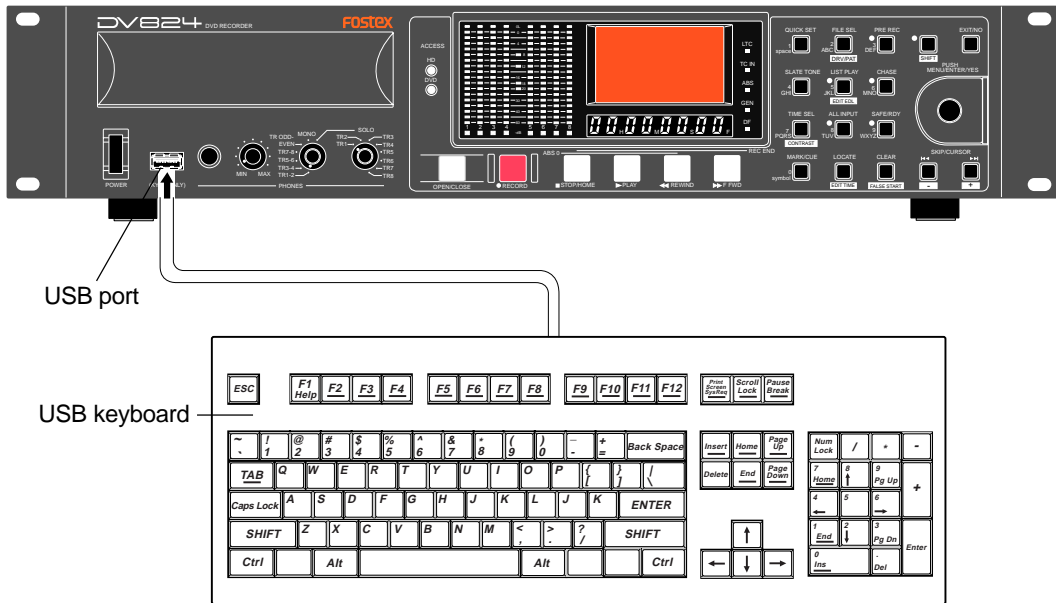

F1 key	Enters the "Edit file name" menu item of the "DISK UTILITY" menu in the MENU mode.
F2 key	Executes the Circle Take function.
F3 key	Enters the "Default file name" menu item of the "SYS SETUP" menu in the MENU mode.
F4 key	Enters the "Default track name" menu item of the "SYS SETUP" menu in the MENU mode.

↑, ↓, ←, → keys	Move the cursor or scroll the screen.
BS key	Executes "back space" during character entry.
DEL key	Executes "delete" during character entry.
ESC key	Acts the same as the [EXIT/NO] key on the panel.
ENTER key	Acts the same as the [ENTER/YES] key on the panel.
HOME key	Returns to the Home screen from a screen in the MENU mode.

ALT key + F key	Acts the same as the [FILE SEL] key on the panel.
ALT key + D key	_____
ALT key + C key	Acts the same as the [MARK/CUE] key on the panel.
ALT key + S key	Enters the "SYS SETUP" menu.
ALT key + U key	Enters the "DISK UTILITY" menu.
ALT key + Q key	Enters the "Quick setup" mode.
ALT key + E key	Enters the "EDIT EDL FILE" menu.
ALT key + T key	Enters the "TC SETUP" menu.
CTRL key + L key	Acts the same as the [LOCATE] key on the panel.

Chapter-5: Recording/playback

Table of contents

Basic audio recording	44
Setup for recording in quick setup mode	44
Entering the quick setup mode	45
Input signal selection	45
TC frame rate selection	46
System clock reference selection	47
Sampling frequency and bit length selection	47
TC generator setting	47
Recording track selection	48
Clock pull up/pull down setting	48
Next file name setting	49
Other settings	50
Reference level setting	50
Recording level setting	50
Digital input channel setting	50
Time display mode selection	51
Headphone monitor selection	51
Starting recording	52
Canceling recording (False Start)	54
Recording in Pre rec mode	54
Recording the slate tone	55
Cue point setting	56
Setting a cue point on the fly during audio recording	56
Viewing the cue point list	56
Editing a cue point	57
Editing a cue label	57
Editing cue point data	58
Deleting a cue point	58
Adding a new cue point to the cue point list	58
Basic playback	59
Normal playback	59
Cueing playback	60
Skip/locate functions	61
Skipping through files	61
Skipping through cue points	61
Locating to the beginning or end of a file	61
Locating to the last located point	61
Locating to a desired time point	62
Locating to a desired cue point	62

Basic audio recording

Before making basic analog or digital audio recording, you need to make some settings.

If you set a blank disk and start up the unit, "-No files!-" is shown on the display, while the indicators shown below are lit.

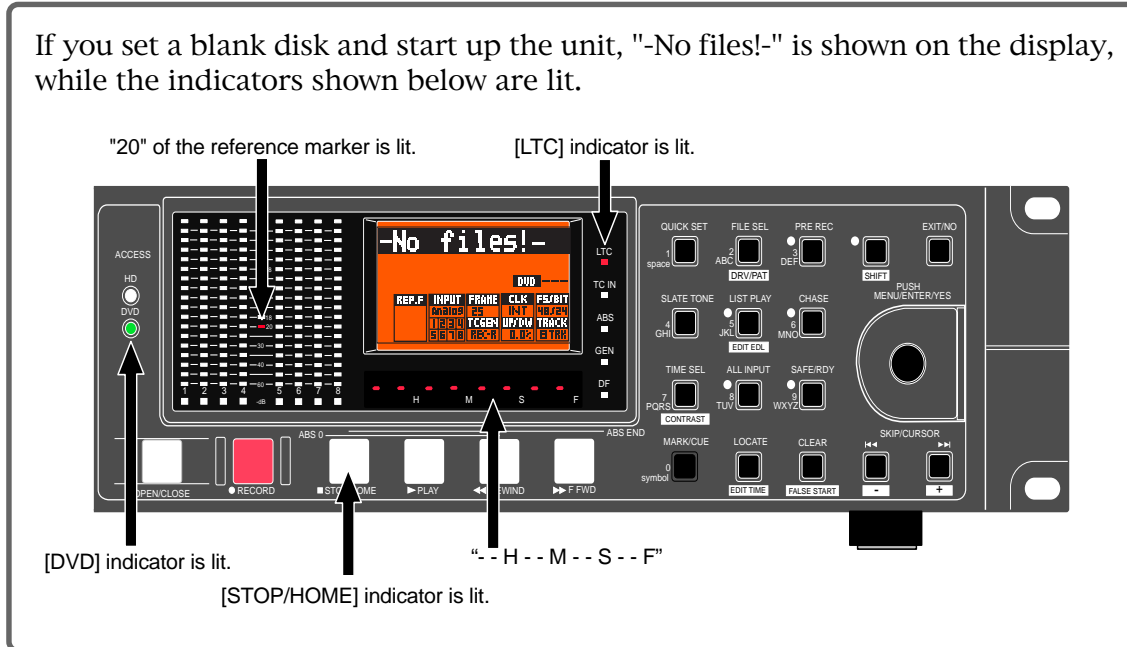

Setup for recording in quick setup mode

Before starting audio recording, you can make necessary settings in the quick setup mode.

Quick setup mode

In the quick setup mode, you can make basic settings required for recording via the Home screen, while you can make all preferences for the unit via the appropriate items in the MENU mode.

You can make settings of the items in the status information area pointed by the arrow below.

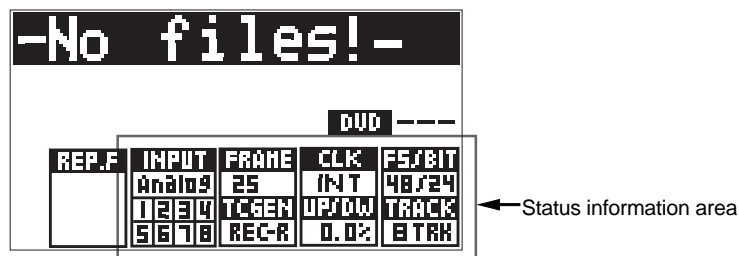

<Note>: "UP/DW" in the status information area can be edited only when the optional TC/SYNC card is installed.

<Note>: In the quick setup mode, you can also set the next file name (see page 49 for details), as well as set the CD stop mode for audio CD playback (see page 65 for details).

Entering the quick setup mode

You can enter the quick setup mode by following the procedure below.

- 1) While "-No files!-" is shown on the Home screen, press the [QUICK SET] key.
By default, "INPUT" in the status information area flashes.

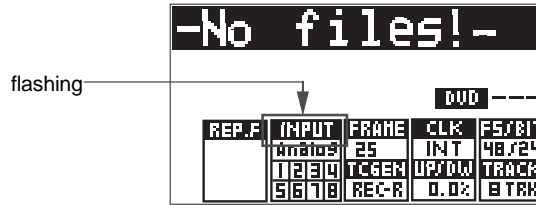

In this condition, rotating the [MENU] dial (or pressing the [SKIP/CURSOR] keys) moves the flashing position in the following order.

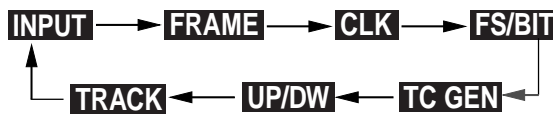

- 2) Select the desired item and press the [ENTER/YES] key.
The current option of the selected item starts flashing and you can now select the option using the [MENU] dial.
- 3) Use the [MENU] dial to select the desired option and press the [ENTER/YES] key.
The selected option is set.
- 4) To exit the quick setup mode, press the [EXET/NO] key (or the [STOP/HOME] key).
See the following for details about each item.

Input signal selection ("INPUT" of the status information area)

By selecting "INPUT" and pressing the [ENTER/YES] key, you can select the input signal between "Analog" (default) and "Digital". You can also make input signal selection via the "Select Input" item in the "SYS SETUP" menu of the MENU mode (see page 119 for details), as well as via the quick setup mode.

Analog	You can record analog audio signals fed to the [ANALOG INPUT] connectors.
Digital	You can record digital audio signals (AES/EBU or S/P DIF) fed to the [DIGITAL I/O] connector. The unit automatically detects the digital signal format (AES/EBU or S/P DIF).

<Note>: If you select "Digital" but the unit does not receive correct digital signals from the [DIGITAL I/O] connector on the rear panel or does not lock to the digital input signals, "Digital" flashes quickly for warning. When the unit receive correct digital signals and lock to them, "Digital" is steadily lit.

<Note>: When "Digital" is selected, all channels can record digital signals by default. However, if you want to record analog and digital signals simultaneously, set the "Setup digital in" menu item in the "SYS SETUP" menu of the MENU mode appropriately (see page 119 for details). You can select signal source between analog and digital in two channel pairs.

<Note>: The INPUT section in the status information area shows as below depending on the selection between "Analog" and "Digital".

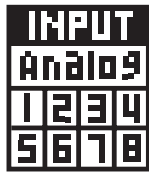

When selecting "Analog"

The left screen example shows when "Analog" is selected here. All channels (1 through 8) can record analog audio signals, regardless of the "Setup digital in" setting in the "SYS SETUP" menu.



When selecting "Digital"

The left screen example shows when "Digital" is selected here. All channels (1 through 8) lock to digital input signals and can record them. In this example, the "Setup digital in" setting in the "SYS SETUP" menu is the default (i.e. all channels are set to "Digital").

If a channel does not lock to the digital input signal, it automatically switches to select analog input, while the corresponding channel number and "Digital" flash quickly for warning.

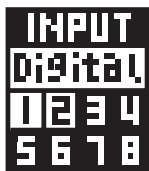

When selecting "Digital"

The left screen example shows when "Analog" is selected here, however, the "Setup digital in" setting in the "SYS SETUP" menu is as below.

- channels 1-2: "Analog"
- channels 3-4, 5-6 and 7-8: "Digital"

In this case, you can record analog and digital signals together. If a channel does not lock to the digital input signal, it automatically switches to select analog input, while the corresponding channel number and "Digital" flash quickly for warning.

TC frame rate selection ("FRAME" of the status information area)

You can select the frame rate of LTC recorded together with audio (or time code recorded when the optional TC/SYNC card is installed).

By selecting "FRAME" and pressing the [ENTER/YES] key, you can select the desired frame rate from among the following (the default is "25").

The unit records LTC together with audio signals. By default, "01h00m00s00f" is stamped at the beginning (one-hour offset to ABS) and the generator records LTC jammed to this start time code. The LTC recording mode ("TC GEN" mode) is set to "Rec Run" by default, so each time you make audio recording, continuous LTC is recorded.

You can also set the time code frame rate via the "Frame rate" menu item in the "TC SETUP" menu of the MENU mode (see page 127 for details). You also can edit the LTC start time via the "Default LTC Start" menu item in the "TC SETUP" menu of the MENU mode (see page 131 for details).

23.97	American motion picture -0.1%
24	American motion picture
25	European film/PAL-SECAM video EBU
29.97DF	NTSC color with real time adjust
29.97ND	NTSC color
30	NTSC video/film
30DF	NTSC video/film

System clock reference selection ("CLK" of the status information area)

You can select the system clock reference.

By selecting "CLK" and pressing the [ENTER/YES] key, you can select the clock reference from among the following (the default is "INT").

To make recording with internal clock reference, select "INT" (default). To make the unit locked to an external digital or word clock, select "Digital" or "Word". In addition, you can select "Video" if the optional TC/SYNC card is installed. You can also select the system clock reference via the "Sync Clock" menu item in the "TC SETUP" menu of the MENU mode (see page 127 for details).

INT	The unit follows the internal clock.
DIGI	The unit follows a digital input clock.
WORD	The unit follows an external word clock.
VIDEO	Available only when the optional TC/SYNC card is installed. The unit follows an external video clock.

<Note>: When "DIGI" (or "WORD") is selected but the unit does not receive a correct digital (or word) signal or does not lock to the reference signal, "DIGI" (or "WORD") quickly flashes. In such a case, check cable connection, etc.

<Note>: When the system clock is set to "DIGI" or "WORD", the FS of a file to be played back must match the FS setting of the unit. Otherwise, you cannot play back the file.
In such a case, make the FS setting of the unit to match the FS of the file.

Sampling frequency and bit length selection ("FS/BIT" of the status information area)

By selecting "FS/BIT" and pressing the [ENTER/YES] key, you can select a sampling frequency and bit length combination from among the following (the default is "48/24").

You can also select a sampling frequency and bit length combination via the "Record FS&Bit" menu item in the "SYS SETUP" menu of the MENU mode (see page 117 for details).

Option	FS/BIT	Option	FS/BIT
22/16	22.05kHz/16bit	48/24	48kHz/24bit
44/16	44.1kHz/16bit	88/24	88.2kHz/24bit
48/16	48kHz/16bit	96/24	96kHz/24bit
44/24	44.1kHz/24bit		

TC generator setting ("LTC GEN" of the status information area)

When the optional TC/SYNC card is installed, this item selects the time code recording mode. When the optional TC/SYNC card is not installed, this item selects the recording mode of LTC which is always recorded simultaneously with audio signals.

When the optional TC/SYNC card is not installed, by selecting "LTC GEN" and pressing the [ENTER/YES] key, you can select a desired LTC recording mode between "REC R" and "EXT" (the default is "REC R"). See the table below for details of these modes. You can also select the TC generator setting via the "Gen mode" menu item in the "TC SETUP" menu of the MENU mode (see page 80 and 128 respectively).

REC R (Rec Run)	The first time you start recording, the generator stamps "01h00m00s00f" as the LTC start time at the beginning of the file, and records LTC jammed to this start time code. The next time you start recording, LTC continued from the LTC on the previous file is recorded.
EXT (Ext Run)	Every time you start recording, the generator stamps "01h00m00s00f" as the LTC start time at the beginning of the file, and records LTC jammed to this start time code. In other words, every file has LTC which starts from "01h00m00s00f".

<Note>: The LTC start time is set to "01h00m00s00f" by default. You can edit it via the "Default LTC start" menu item in the "TC SETUP" menu of the MENU mode (see page 131 for details). For details about the TC generator mode when the optional TC/SYNC card is installed, see page 77. You can also select a TC recording mode via the "Gen mode" menu item in the "TC SETUP" menu of the MENU mode (see page 132 for details).

Recording track selection ("TRACK" of the status information area)

By selecting "TRACK" and pressing the [ENTER/YES] key, you can select the number of recording tracks from among "1", "2", "4", "6" and "8" (the default is "8".)

You can also select the number of recording tracks via the "Record tracks" menu item in the "SYS SETUP" menu of the MENU mode (see page 117 for details).

Depending on a DVD-RAM disk, there are some restrictions as shown in the table below.

FS/BIT	Recording tracks	4.7GB	4.7GB (3x speed)	Recordable time (minutes)		
				22.05kHz	44.1kHz	48kHz
22.05kHz/16bit 44.1kHz/16bit 48kHz/16bit	Mono	Yes	Yes	1,676	838	770
	Stereo	Yes	Yes	838	419	385
	Multi (4 track)	Yes	Yes	418	209	192
	Multi (5 track)	Yes	Yes	334	167	154
	Multi (6 track)	Yes	Yes	279	140	128
	Multi (8 track)	Yes	Yes	209	105	96
				44.1kHz	48kHz	
44.1kHz/24bit 48kHz/24bit	Mono	Yes	Yes	558	513	
	Stereo	Yes	Yes	279	256	
	Multi (4 track)	Yes	Yes	139	128	
	Multi (5 track)	Yes	Yes	111	102	
	Multi (6 track)	Yes	Yes	93	85	
	Multi (8 track)	No	Yes	69	64	
				88.2kHz	96kHz	
88.2kHz/24bit 96kHz/24bit	Mono	Yes	Yes	279	256	
	Stereo	Yes	Yes	139	128	
	Multi (4 track)	No	Yes	69	64	
	Multi (5 track)	No	No			
	Multi (6 track)	No	No			
	Multi (8 track)	No	No			

Clock pull up/pull down setting ("UP/DW" of the status information area)

When the optional TC/SYNC card is installed, this item allow making the pull up/pull down setting of the sampling clock/internal TC frame rate if the clock reference is set to "INT".

By selecting "UP/DW" and pressing the [ENTER/YES] key, you can select from among "0.0%" (default), "+0.1%" and "-0.1%".

You can also make the pull up/pull down setting via the "Pull Up/Down" menu item in the "SYS SETUP" menu of the MENU mode (see page 118 for details).

+0.1%	The current FS and internal TC frame rate are pulled up +0.1%.
0.0%	Normal setting (default).
-0.1%	The current FS and internal TC frame rate are pulled down -0.1%.

<Note>: You can make the pull up/down setting only when the clock reference is set to "INT". If you select "UP/DW" when any external clock reference ("WORD", "VIDEO" or "DIGITAL") is selected, "Void!" is shown and you cannot make setting.

Next file name setting ("NEXT" of the status information area)

You can set the next file name while the unit is in the record ready mode (i.e. the [SAFE/READY] key is set to ON).

When turning on the [SAFE/READY] indicator, the next file name and disk remaining time are shown on the Home screen. By pressing the [QUICK SET] key in this condition, you can make settings of items in the status information area. Use the [MENU] dial to select "NEXT".

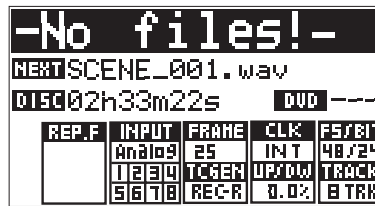

This item defines the name of the audio file created when starting recording next time. The next file name is set according to the "default file name", which is initially "SCENE NAME + TAKE No.". In the example above, the next file name is set to "SCENE_001.wav".

By selecting "NEXT" and pressing the [ENTER/YES] key, the display automatically brings up the screen for the "Def. file name" menu item in the "SYS SETUP" menu of the MENU mode.

In this screen, you can edit the default scene name and take number (by default, "S" of "SCENE" flashes).

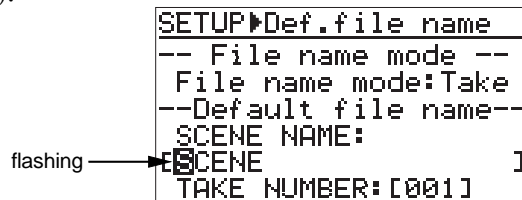

You can edit the character at the cursor position using the [MENU] dial (or alphanumeric keys). Up to 18 characters can be entered.

You can move the cursor position using [SKIP/CURSOR I◀◀ ▶▶I] keys.

Pressing the [CLEAR/FALSE START] key repeatedly clears all the characters behind the cursor position.

After entering the desired scene name, pressing the [ENTER/YES] key confirms your setting, while the screen prompts you to enter the take number.

Enter the desired take number with the similar manner, and press the [ENTER/YES] key to confirm your setting.

After completing editing, press the [STOP/HOME] key to exit the MENU mode.

<Note>: The file name mode for the default file name is set to "Take" by default. You can set it to "Date" if you want. When setting it to "Date", the realtime clock data is reflected to a file name. See "Default file name setting" on page 115 for details.

Other settings

There are some settings besides those made in the quick setup mode.

Reference level setting

The reference level is set to "-20dB" by default. You can change to set this level to "-18dB" or "-12dB" via the "Ref.level" item in the "SYS SETUP" menu of the MENU mode (see page 122 for details).

In the level meter section, the associated level indicator with the selected level is lit.

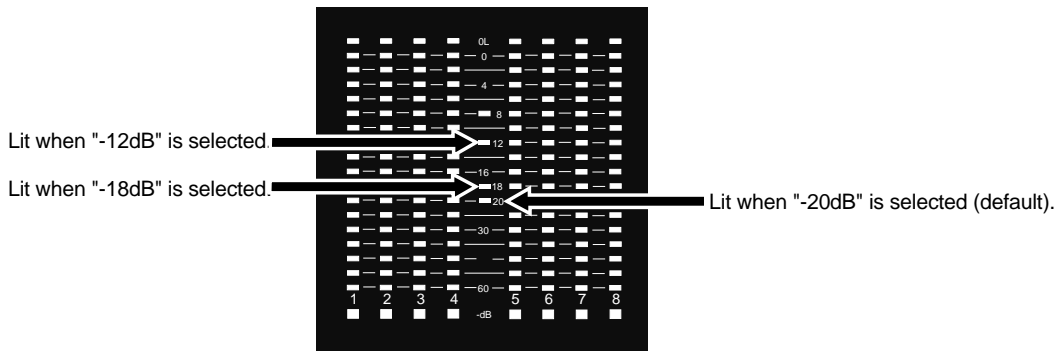

Recording level setting

The DV824 does not provide a function for adjusting the recording level.

When recording analog audio signals, you should adjust the recording level by controlling the source output level.

You can check the input level while the [ALL INPUT] indicator is lit.

Before starting recording, you should control the source output level while checking the level meter and monitoring the source via the headphones.

<Note>: The "ALL INPUT" mode is off by default. However, by setting the "Auto EE mode" in the "SYS SETUP" menu of the MENU mode to "On", the "ALL INPUT" mode is always active except during playback (see page 121 for details).

Digital input channel selection

When recording digital audio signals by setting "INPUT" to "Digital" in the quick setup mode, you can select digital recording channels via the "Setup Digital in" menu item in the "SYS SETUP" menu of the MENU mode (see page 119 for details). By default, all channels are set to "Digital" in this menu item. Therefore, unless you change the "Setup Digital in" setting, you can record digital sources for all channels simply by setting "INPUT" to "Digital".

<Note>: The "Setup Digital in" menu item in the "SYS SETUP" menu of the MENU mode selects the input channel sources between digital and analog for four channel pairs (channels 1-2, 3-4 and 5-6). For example, if you change the setting for channels 1-2 to "Analog", you can record analog sources for channels 1 and 2, while record digital sources for channels 3 through 8.

<Note>: When recording digital sources, the FS must match between the DV824 and the external device.

Time display mode selection

The 7-segment time display shows time data in the currently selected time mode. You can select the time mode between the following using the [TIME SEL/ CONTRAST] key. By default, time data is shown in the "LTC" mode when the unit is turned on.

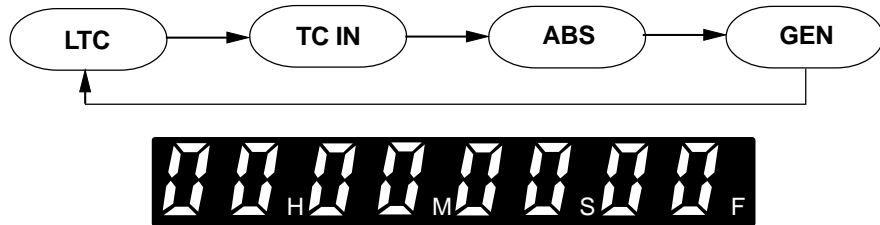

LTC	The time display shows LTC currently being played back or recorded in "h:m:s:f" format.
TC IN	When the optional TC/SYNC card is installed, the time display shows external time code fed to the [TIME CODE INPUT] connector in "h:m:s" format. In the frame field, the frame rate (24, 29, etc.) of the receiving time code is shown. When the optional TC/SYNC card is not installed, "--H --M --S --F" is shown.
ABS	The time display shows ABS currently being played back or recorded in "h:m:s:f" format.
GEN	When the optional TC/SYNC card is installed, the time display shows time code generated by the internal TC generator in "h:m:s:f" format only if "Gen mode" is set to "Free Run" (see page 128 for details about "Gen mode" setting). <Note> : When the optional TC/SYNC card is not installed, "--H --M --S --F" is shown.

Headphone monitor selection

You can select the headphone monitor source using the rotary switches in the PHONES section.

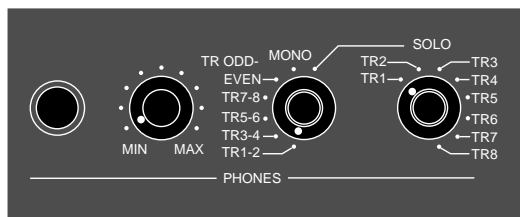

SOLO	Monitors a solo track (1 to 8) selected by the [SOLO] select switch.
MONO	Monitors all available tracks in mono.
TR ODD-EVEN	Monitors all available tracks in stereo (odd tracks to L, even tracks to R).
TR7-8	Monitors tracks 7 and 8.
TR5-6	Monitors tracks 5 and 6.
TR3-4	Monitors tracks 3 and 4.
TR1-2	Monitors tracks 1 and 2.

Starting recording

After making the necessary settings for recording appropriately, you can start recording.

The DV824 automatically creates a new audio file (BWF) on the disk each time you make recording.

In the following description, it is assumed that a formatted blank DVD-RAM disk is set to the disk tray and the unit is receiving correct analog or digital audio signals.

1) Press the [SAFE/RDY] key to make the unit record ready.

The [SAFE/READY] indicator starts flashing, while the track indicators of the recording tracks below the level meters start flashing.

The Home screen changes as below.

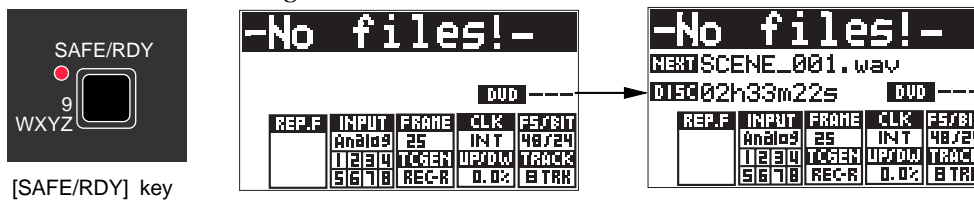

The Home screen now shows the name of the audio file (New file) created when recording starts, as well as disk remaining recordable time.

The file name format is set to the "<SCENE NAME> + <TAKE NUMBER>" format by default. Therefore, the name of the first audio file is "SCENE_001.wav", as shown above. The remaining time indication changes to show the remaining recordable time of the current file when recording starts (see page 118 for details).

<Note>: The file name automatically set when recording is made is called "default file name". You can change the default file name type to "Creation time/date.", instead of "<SCENE NAME> + <TAKE NUMBER>" (see page 115 for details). You can also change the file name later (see page 142 for details).

The remaining recordable time varies depending on the FS/bit selection and the number of recording tracks.

2) Press the [RECORD] key to start recording.

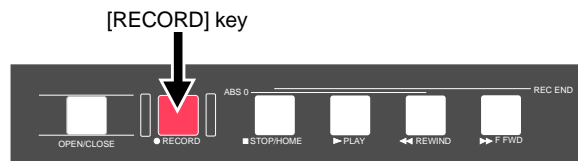

When the time mode is set to "LTC", the time display shows LTC starting from "01H00M00S00F" in realtime. The same time code is recorded to the audio file. That is, "01h00m00s00f" is stamped at the beginning (ABS 0) and the generator records LTC jammed to this start time code.

With the default "TC GEN" mode ("REC R"), each time you make audio recording, the continuous LTC to the previous file is recorded. That is, after the first file, the first frame of the next file must have the time code of the last frame of the previous file plus one.

When the "TC GEN" mode is set to "EXT", each file starts from the LTC set by the "Default LTC start" item in the "TC SETUP" menu (the default is "01H00M00S00F"). While the optional TC/SYNC card is installed, the LTC time is recorded if the unit is receiving external LTC.

You can edit the LTC start time via the "Edit LTC start" menu item in the "TC SETUP" menu of the MENU mode (see page 132 for details).

3) **To stop recording, press the [STOP/HOME] key.**

When recording ends, the Home screen changes as shown below left. By pressing the [SAFE/RDY] key to exit the record ready mode, the file name and disk remaining time are dismissed from the Home screen as shown below right.

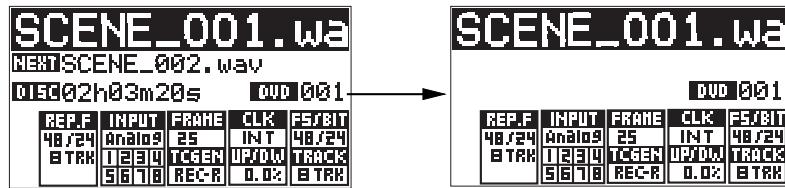

From the Home screen above left, you can see that the "SCENE_001.wav" audio file has been created and the next file name is "SCENE_002.wav".

In the "REP.F" field, you can see the FS and bit length of the recorded file.

<Note>: If you do not make the next recording after the first recording ends, press the [SAFE/READY] key to exit the record ready mode (i.e. to turn off the indicator).

4) **By pressing the [◀◀ REWIND] key while holding down the [STOP/HOME] key, the unit locates to the beginning of the recorded file ("Locate ABS 0" function).**

Pressing the [PLAY] key starts playback of the recorded audio file from the beginning. **See page 59 for details about playback.**

<Tip>

If recording was not successful, you can cancel it. See "Canceling recording" on the next page.

<Tip>

You can also use the "Pre recording" function which prevents missing the start of a take (see page 54 for details).

<Tip>

During recording, you can set cue points which can be used as markers (see page 56 for details).

You can also record the slate tone at the beginning of the audio file (see page 55 for details).

Canceling recording (False Start)

If your recording take is not successfully made, you can cancel the take after recording and clear the file from the disk by executing the "False start".

<Notes>

- You can cancel only the take most recently recorded, even though you play it back or switch to another audio file after recording. Once you cancel the take and clear the file, you cannot restore it anymore.
- If you switch the hard disk partition after recording while the optional hard disk drive is installed, you cannot execute the False start.
- You cannot execute the False start while the unit is in the "Auto Copy" mode (see "Auto copy function" on page 83).

- 1) While the unit is stopped, press the [SHIFT] key to turn on the [SHIFT] indicator and press the [CLEAR/[FALSE START]] key.

The popup message as below appears on the Home screen, asking whether executing False start or not.

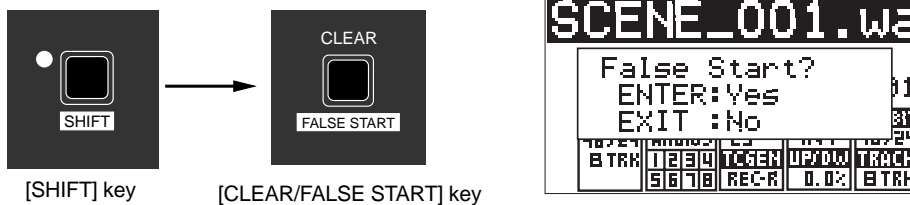

- 2) To cancel the most recent take, press the [ENTER/YES] key.

The display shows "Please wait!", followed by "Completed!", and returns to the Home screen for the audio file which is recorded before the canceled file. If you press the [EXIT/NO] key instead of the [ENTER/YES] key above, the display returns to the Home screen for the most recently recorded audio file.

When canceling the take and clear the audio file, the name of the cleared audio file is shown in the next file name field and the disk remaining time returns to the value before the last recording is made.

Recording in Pre rec mode

The DV824 features the "Pre recording" function (in this manual, we say "Pre rec mode" for the DV824 status when the "Pre recording" function is active). In the Pre rec mode, recording is made from the audio pooled in the buffer. This prevents missing the start of a take. For example, if you press the [RECORD] key a few seconds after an important interview starts, there is no problem. Because the beginning part of the interview recorded in the buffer also can be recorded to the disk.

By default, pre recording time of the buffer is set to ten seconds. Via the "Pre rec time" menu item in the "SYS SETUP" menu of the MENU mode, you can set the pre recording time to the desired time between one and ten seconds in one second steps (see page 120 for details).



[PRE REC] key

You can select On/Off of the Pre rec mode using the [PRE REC] key. When it is set to On, the [PRE REC] indicator is lit. When Off, it is unlit.

<Note>: If you execute pre recording at 88.2k or 96k FS, the pre recording time automatically reduces to half the selected value. For example, if the pre recording time is set to ten seconds, the buffer stores only five seconds of audio data.

<Tip>

When you stop recording in the Pre rec mode, the unit will stop after executing "post recording" which records audio data currently stored in the buffer.

<Note>: In the Pre rec mode, if you switch the Fs/Bit setting, wait for ten seconds before starting recording .
Otherwise, the audio signal stored in the buffer is recorded with altered pitch.

Recording the slate tone

The DV824 can generate and record the slate tone.

While holding down the [SLATE TONE] key, the slate tone (at 1 kHz, reference level) is fed to all channels, as well as output from the [ANALOG OUT] connectors.

You can record the slate tone to the beginning of an audio file during recording, as well as match the level between the DV824 and an external device.

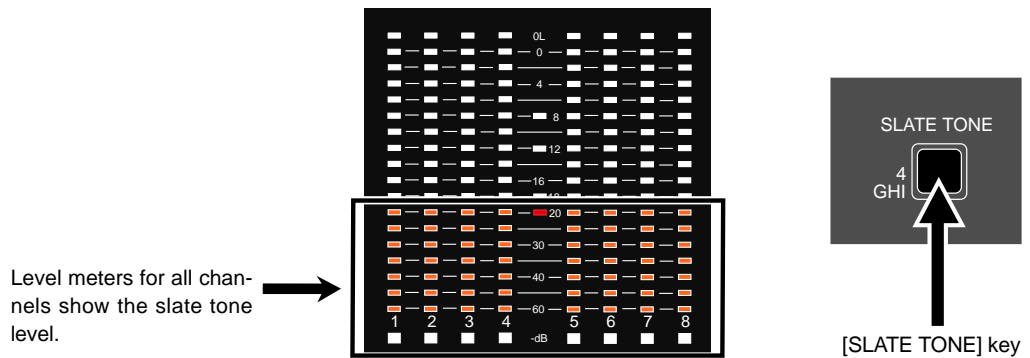

<Tip>

You can clear the peak hold of the level meters by pressing the [CLEAR/[FALSE START]] key. You can set the peak hold time of the level meter via the "Peak hold" menu item in the "SYS SETUP" menu of the MENU mode (by default, three seconds). **See page 122 for details.**

<Tip>

In the "SYS SETUP" menu of the MENU mode, the "Tone Rec mode" menu item is available. This item selects the mode for slate tone recording. By default, it is set to "Off" and the tone is not automatically recorded. Use this menu item when you want to use the slate tone function (**see page 121 for details**).

<Note>: When the Pre rec mode is active, the slate tone is not recorded at the beginning of recording even though the slate tone Rec On/Off is set to "On". The pop tone can be recorded at the recording end.

Cue point setting

The DV824 provides the following two ways of setting a cue point.

1. During audio recording, you can set a cue point "on-the-fly" at the desired point.
2. During playback or while stopped, you can set a cue point using the cue point list on the screen.

Setting a cue point on the fly during audio recording

You can set a "cue point" at the point you press the [MARK/CUE] key during recording. Up to 99 cue points can be set.

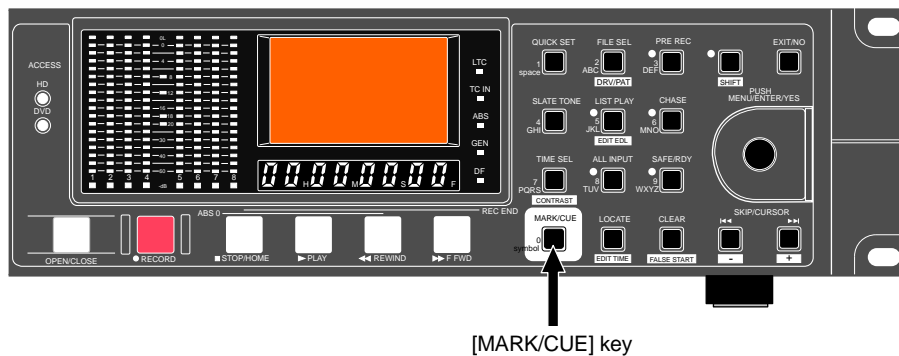

If you press the [MARK/CUE] key during recording, a cue point holding the current time value is set, while "Cue:**Stored!" (** is a cue number) and the cue time value are briefly shown on the screen.

Setting a cue point repeatedly counts up the cue number.

You can view cue points after recording.

Viewing the cue point list

Pressing the [MARK/CUE] key while the unit is stopped brings up the CUE LIST screen as shown below. In this screen, the existing cue points are listed. In the screen example below, cue points 01 through 04 are set, while no data is stored on and after cue point 05. The time data is shown by the format based on the time display indicator).

Labels are automatically given to the recorded CUEs. "**BC\$START**" to CUE 01, "**BC\$END**" to CUE 02, and "Cue 03", "Cue 04"... "Cue 99" to CUE 03 and the following cues. "**BC\$START**" and "**BC\$END**" for CUE 01 and CUE 02 are used as the start and end points which specify the playback range for list play (see "List play function" described later). Therefore, you can change the playback range for list play by editing the "**BC\$START**" and/or "**BC\$END**" point(s). See "Editing a cue point" on the next page for details.

CUE LIST (LTC)		
01	BC\$START	00h22m34
02	BC\$END	00h51m20
03	Cue 03	01h25m08
04	Cue 04	01h40m11
05		--h--m--
06		--h--m--

(*) "**BC\$START**" and "**BC\$END**" are the label names reserved by the BWF-J specification.

On this list screen, you can not only view cue points but also locate to a cue point, edit a cue point and add a new cue point to the list.

Editing a cue point

By selecting a desired cue point in the CUE LIST screen, you can edit its label or point (time data) or delete it.

By highlighting a desired cue point and press the [ENTER/YES] key, the display changes to show the screen for editing the selected cue point (by default, "Label" flashes on the screen).

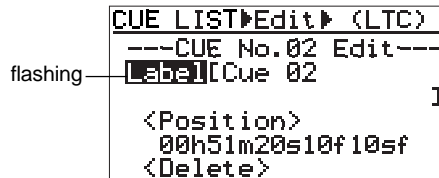

Editing a cue label

To edit a cue point label, press the [ENTER/YES] key while "Label" flashes.

The first character of the current label flashes, showing that you can now edit it. Use the [MENU] dial (or alphanumeric keys) to edit the label. After editing the label, press the [ENTER/YES] key ("Label" starts flashing again).

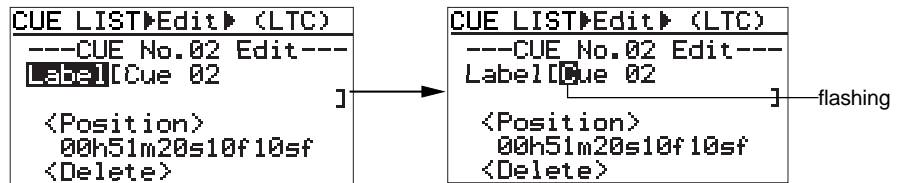

<Notes for editing a label>

When using the alphanumeric keys for entering characters, pressing any other alphanumeric key moves the cursor to the right automatically.

You can move the cursor position using the [SKIP/CURSOR] keys. Pressing the [CLEAR/FALSE START] key clears the right next character to the cursor position. To delete the whole label, press the [CLEAR/FALSE START] key repeatedly when the first character flashes.

<Note>

By labeling "BC\$START" and/or "BC\$END" to any other desired cue point(s), you can change the playback range for list play (see "List play function" described later).

In the example shown below, the labels for CUE 02 and CUE 04 are edited to "Cue 02" and "BC\$END" respectively. After edited, if you execute list play in the "Song_Link" mode, this file is played back within the range between "CUE 01" (00h 22m 34s) and "CUE 04" (01h 40m 11s).

If you want to play back all data of this file during list play, delete the cues labeled "BC\$START" and "BC\$END" or edit "BC\$START" and "BC\$END" to other labels.

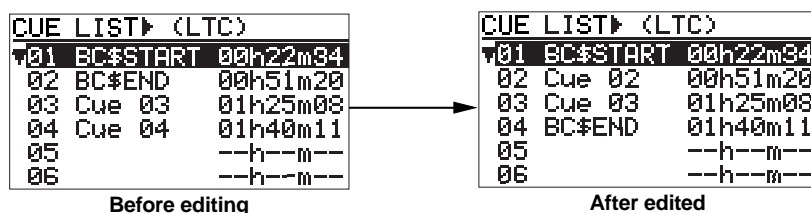

Editing cue point data

To edit cue point data, use the [MENU] dial to select "Position" while "Label" is flashing and press the [ENTER/YES] key.

The subframe value of the current time data flashes, showing that you can now edit it.

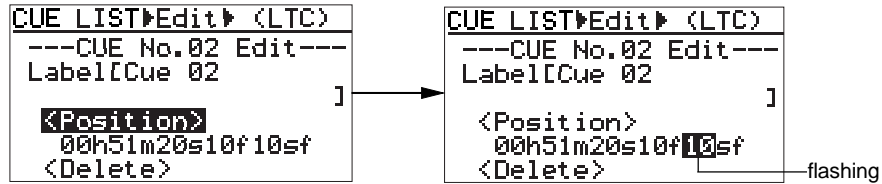

Select the edit point using the [SKIP/CURSOR] key, edit the value using the [MENU] dial, and confirm the setting by pressing the [ENTER/YES] key (the display returns to the CUE LIST screen).

<Note>: Regardless of the cursor position, pressing the [CLEAR/[FALSE START]] key resets the time data to "00h00m00s00f".

Deleting a cue point

To delete an unnecessary cue point, select "Delete" using the [MENU] dial and press the [ENTER/YES] key ("Sure?" flashes).

Press the [ENTER/YES] key again to delete the cue point from the list.

The display returns to the Home screen.

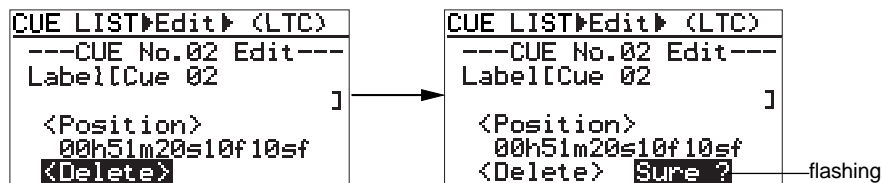

<Note>: After deleting a cue point, the label column of the cue point becomes empty while the time value column shows "--h--m--s--f--".

Adding a new cue point to the cue point list

While the CUE LIST screen is shown, you can add a new cue point to the list.

Select a desired cue number which does not hold data.

By pressing the [ENTER/YES] key, time data of the current recorder position is set as the cue point.

In the example below, Cue 05 is set when the current recorder position is "01h 58m 20s **f ** sf" (LTC time).

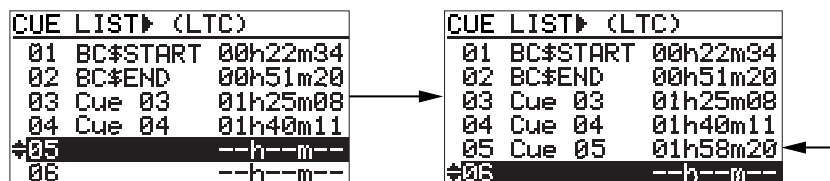

Basic playback

Normal playback

<Note>: The DV824 provides the list play function.

Using the list play function, you can link multiple audio files which have the same number of tracks and FS, and play them back continuously.

See "List play function" in "Advanced operations" on page 66 for details.

<Note>: When the system clock is set to "DIGI" or "WORD", the FS of a file to be played back must match the FS setting of the unit. Otherwise, you cannot play back the file.

In such a case, make the FS setting of the unit to match the FS of the file.

- 1) **Set a recorded disk to the tray.**
- 2) **Select a desired audio file you want to play back. (If only one audio file is recorded, you can skip this step.)**
You can select a desired audio file from the FILE SEL screen or using the [SKIP/CURSOR |◀◀▶▶|] key.

<Selecting a file from the FILE SEL screen>

Pressing the [FILE SEL/DRV/PAT] key brings up the FILE SEL screen, on which all audio files recorded on the current disk is shown.

FILE SEL	
[FNO]	[FILE NAME]
001	Action-001.wav
002	Action-002.wav
003	Action-003.wav
004	Action-004.wav
005	Action-005.wav

Use the [MENU] dial to select a desired audio file from the list and press the [ENTER/YES] key. The selected audio file is loaded and the display shows the Home screen.

Instead of directly pressing the [FILE SEL/DRV/PAT] key, you can bring up the FILE SEL screen above the following procedure.

- 1) Press the [ENTER/YES] key while stopped to enter the MENU mode.
- 2) Use the [MENU] dial to select the "FILE SEL" menu.
- 3) Press the [ENTER/YES] key.

<Selecting a file using the [SKIP/CURSOR |◀◀▶▶|] key>

When the "Skip mode" menu item in the "SYS SETUP" menu of the MENU mode is set to "File", you can select a desired file using the [SKIP/CURSOR |◀◀▶▶|] key.

By default, "Skip mode" is set to "File". If it is set to "Cue", set it back to "File" (**see page 123 for details**).

Pressing the [SKIP/CURSOR |◀◀▶▶|] key skips forward or backward through audio file entries. See "Skip/locate functions" on page 61.

- 3) **Press the [▶ PLAY] key to start playback of the selected audio file.**
See page 51 for details about how to monitor the sound.
- 4) **To stop playback, press the [STOP/HOME] key.**
The unit automatically stops if it runs to the end of the file.
- 5) **If you want to play back the file from the beginning again, press the [◀◀ REWIND] key while holding down the [STOP/HOME] key to skip back to "ABS 0" ("LOCATE ABS 0" function), and press the [▶ PLAY] key.**

Cueing playback

In the cueing mode, forward or backward cueing (at up to 2 x speed) is possible (see also <Note> below).

During playback of an audio file, pressing the [▶▶ F FWD] (or [◀◀ REW]) key enters the cueing mode.

You can monitor the sound during the cueing mode.

To cancel the cueing mode, press the [▶ PLAY] key.

<Note>: The maximum cueing speed differs depending on the FS/Bit and number of tracks of an audio file. Depending on the condition, the sound may be occasionally mute during cueing playback.

Skip/locate functions

The DV824 offers comprehensive skip/locate functions.

Skipping through files

When more than one audio file is recorded on the current DVD-RAM disk, you can quickly skip to the beginning (ABS 0) of a desired audio file.

By pressing the [◀◀] or [▶▶] ([SKIP/CURSOR]) key while the unit is stopped, you can skip forward or backward a file. Therefore, pressing the [◀◀] or [▶▶] key as many times as required skips to the beginning of the desired file.

<Note>: To skip through files using the [◀◀] and [▶▶] keys, the "Skip mode" menu item in the "SYS SETUP" menu of the MENU mode must be set to "File" (see page 123 for details). The default is "File". If it is set to "CUE", change the setting.

Skipping through cue points

You can quickly skip to a desired cue point on the current audio file.

By pressing the [◀◀] or [▶▶] ([SKIP/CURSOR]) key while the unit is stopped, you can skip to the next or previous cue point. Therefore, pressing the [◀◀] or [▶▶] key as many times as required skips to the desired cue point.

<Note>: To skip through cue points using the [◀◀] and [▶▶] keys, the "Skip mode" menu item in the "SYS SETUP" menu of the MENU mode must be set to "CUE" (see page 123 for details). The default is "File", so change it to "CUE".

Locating to the beginning or end of a file

While the unit is stopped, pressing the [◀◀ REW] key while holding down the [STOP/HOME] key locates to the beginning (ABS 0) of the current file quickly.

While the unit is stopped, pressing the [▶▶ F FWD] key while holding down the [STOP/HOME] key locates to the record end position (REC END) of the current file quickly.

Locating to the last located point

While the unit is stopped, pressing the [LOCATE/EDIT TIME] key locates to the point where you located last time.

Locating to a desired time point

You can locate the unit to any desired point by specifying the time value.

- 1) **While the unit is stopped (or playing back), press the [SHIFT] key to light the [SHIFT] indicator, followed by the [LOCATE/EDIT TIME] key.**
The DV824 enters the time edit mode and the popup window for entering time data appears on the display.

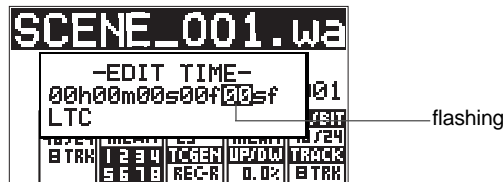

<Note>: The time value can be specified according to the time mode selected before entering the time edit mode. In the screen example above, you can specify the time value based on LTC.

- 2) **Use the [MENU] dial (or alphanumeric keys) to enter the desired time value.**
You can move the cursor position using the [SKIP/CURSOR I<<>>I] keys. Pressing the [CLEAR/FALSE START] key resets the time value to "00h 00m 00s 00f 00sf".

You can enter the time value between "00h00m00s00f00sf" and "23h 59m 59s **f 99sf" (** depends on the frame rate of the audio file).

- 3) **After entering the desired time value, press the [LOCATE/EDIT TIME] key.**
The unit quickly locates to the point at the specified time.

<Note>: If you enter a time value which is out to the current file and press the [LOCATE/EDIT TIME] key, "Out of Zone" is shown and the locate operation is not executed.

Locating to a desired cue point

You can locate the unit quickly to a desired cue point by selecting the cue point from the cue list.

- 1) **While the unit is stopped, press the [MARK/CUE] key.**
The CUE LIST screen appears.

CUE LIST▶ (LTC)		
01	BC\$START	00h22m34
02	BC\$END	00h51m20
03	Cue 03	01h25m08
04	Cue 04	01h40m11
05		--h--m--
06		--h--m--

- 2) **Use the [MENU] dial (or alphanumeric keys) to select the desired cue point from the cue list, and press the [LOCATE/EDIT TIME] key.**
The unit quickly locates to the selected cue point and the display returns to the Home screen.

<Note>: Unlike the function described above in "Skipping through cue points", this function is always available regardless of the "Skip mode" setting in the "SYS SETUP" menu of the MENU mode.

Chapter-6: Advanced operations

Table of contents

Audio CD playback	64
Setting CD stop mode	65
List play function	66
Setting list play mode/Executing list play	68
Viewing linked audio files	69
Locating to the beginning of the play list	69
Locating to the end of the play list	69
Controlling the unit from a video editor	70
Necessary setting (RS422 SETUP menu)	70
RS422 remote setting	70
Device type setting	71
Sync play setting	71
Editor preset setting	71
File data transfer using FTP server function	72
Setting example of PC connection	73
Connecting DV824 directly to PC	73
Connecting DV824 to LAN	74
FTP command details	74
TCP/IP SETUP menu setting	75
IP address setting	75
Subnet mask setting	75
Anonymous on/off setting	75
Login name/password setting	76
TCP/IP Enable mode on/off setting	76
Mac address checking	76
File transfer example between the DV824 and a PC	78
Time code recording/playback (the optional Model 8348 required)	80
Recording time code	80
Frame rate setting	80
TC generator mode setting	80
Playing back time code	81
Time code output setting	81
Jam function (the optional Model 8348 required)	81
Executing jam function	82
Auto copy function (the optional Model 9057 required)	83
Selecting auto copy mode	83
Making auto copy	85
Disk copy function (the optional Model 9057 required)	86
Making Disk copy	86
File copy function (the optional Model 9057 required)	87
Making File copy	87
Dual drive recording (the optional Model 9057 required)	89
Formatting in the "DDR" mode	89
Making dual drive recording	91
Chasing external TC (the optional Model 8348 required)	92
Preparations	92
Chasing	92
Data export to PC (the optional Model 8370 required)	93
Connecting PC to the unit	93
How to unmount the DV824 from the PC	94
Example of copying data to a computer hard disk	94
Example of exporting data to a computer application	95

Audio CD playback

The DV824 can play back audio CDs (in the CD-DA format), as well as play back files on a DVD-RAM disk. You can operate the DV824 for playing back an audio CD in a similar way to an ordinary CD player.

<Note>: The DV824 can play back CD-DA format audio CDs including commercially available audio CDs. Note that, however, it may not be able to play back some CDs such as copy-controlled CDs which are disc-protected. Using the unit, you may play back commercially available audio CDs for your personal use and enjoyment only. You may not use it for any commercial purpose whatsoever. Unauthorized use is a violation of applicable laws and subject to criminal prosecution.

Before playing back an audio CD by the unit, we recommend setting the "CD stop mode" menu item in the "SYS SETUP" menu of the MENU mode appropriately (see the next page).

1) Set an audio CD to the tray and load it.

The unit automatically recognizes the CD as the CD-DA format disc and the display shows the Home screen for audio CD. The screen shows the following information.

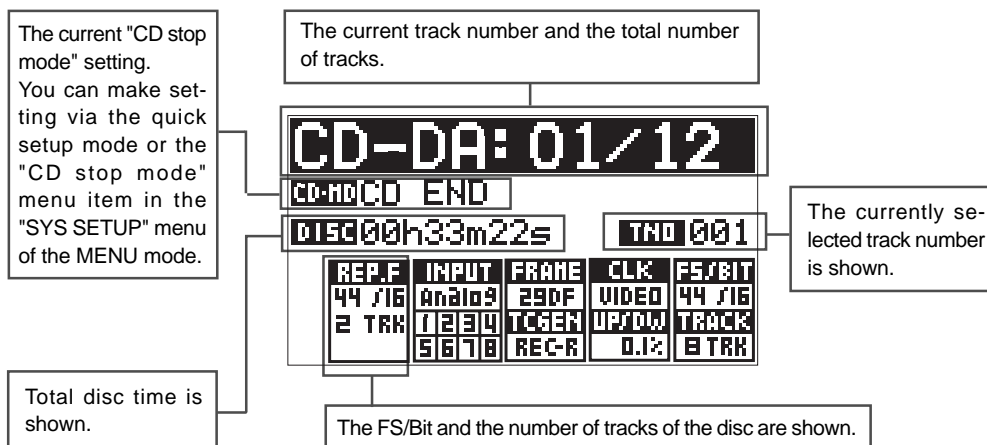

2) Press the [▶ PLAY] key to start playback.

When an audio CD is loaded, you can execute the following operations in addition to normal playback.

• Locating to the beginning (or end) of a disc (see page 61)

While stopped, press the [REWIND] (or [F FWD]) key while holding down the [STOP/HOME] key.

• Locating to a desired time position (see page 62)

Press the [SHIFT] key, followed by the [LOCATE] key. Then enter the desired time value and press the [LOCATE] key.

• Cueing playback (see page 60).

Press the [REWIND] or [F FWD] key during playback.

• Track skip (see page 61)

Press the [SKIP/CURSOR ▶▶] or [SKIP/CURSOR ◀◀] key while stopped or during playback mode.

• Track selection in FILE SEL mode (see the next page)

Track selection in the FILE SEL mode:

While an audio CD is loaded, pressing the [FILE SEL] key brings up the screen for selecting a track of the audio CD, as shown right (the time at the beginning of each track is also shown).

By using the [MENU] dial to select the desired track and pressing the [ENTER/YES] key, the display shows the Home screen for the selected track.

```

CD TRACK SEL
[TIME] -TIME- ]
01 01h00m13s15f00sf
02 01h04m15s05f33sf
03 01h08m32s04f66sf
04 01h11m40s03f00sf
05 01h16m09s02f00sf
    
```

Setting CD stop mode

You can select the CD stop mode which determines how audio CD playback stops. This setting is only effective when playing back an audio CD (CD-DA). It does not affect DVD-RAM disk playback. You can select the CD stop mode by the procedure below, as well as via the quick setup mode.

- 1) **While the unit is stopped, press the [ENTER/YES] key to enter the MENU mode.**
The unit enters the MENU mode and the MENU list screen as below is shown.
- 2) **While "SYS SETUP" is highlighted, press the [ENTER/YES] key.**
The display now shows the SYS SETUP menu screen.

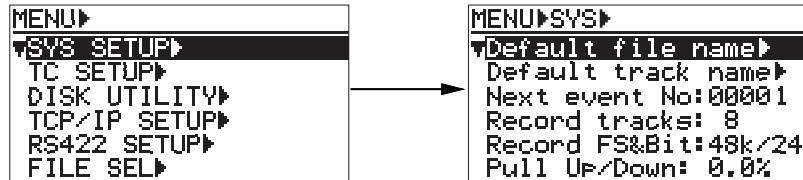

- 3) **Use the [MENU] dial to select the "CD stop mode" menu item and press the [ENTER/YES] key.**
The current option (by default, "CD end") starts flashing and you can now select the desired option.

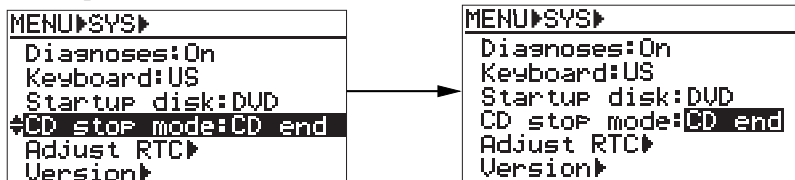

Option	Function
CD end	The unit plays back an audio CD from track 1 to the last track. When playback of the last track ends, the unit automatically stops. This is the default.
Track	When playback of the current track ends, the unit automatically stops.
Repeat	The unit plays back an audio CD from track 1 to the last track repeatedly. It continues playback until you stop it.

- 4) **Use the [MENU] dial to select the desired mode and press the [ENTER/YES] key to confirm your setting.**
Now you complete setting.
- 5) **Press the [STOP/HOME] key to exit the MENU mode.**

Selecting the CD stop mode via the quick setup mode

While the Home screen for an audio CD is shown, press the [QUICK SET] key. Any setting item start flashing.

- Use the [MENU] dial to flash "CD end" and press the [ENTER/YES] key.
- Use the [MENU] dial to select the desired CD stop mode.
- Press the [ENTER/YES] key to confirm the selection.
- Press the [STOP/HOME] key to exit the MENU mode.

List play function

The LIST PLAY function allows linking multiple audio files recorded with the same FS on the disk and play back them continuously.

<Note>: To execute list play by linking audio file entries in an ALE file, you must add the desired audio files to the ALE file created using the "EDIT EDL FILE" menu item. See page 99 for details about the "EDIT EDL FILE" menu item.

There are four "link modes" for playing back linked audio files continuously, as below.

LTC-Link	You can link any audio files recorded with same FS on a disk (or in an ALE file). Each selected file is played back at its original LTC position while LTC runs. If two audio files overlaps the same LTC range, the file which has earlier LTC start time takes priority and is played back while the other file is ignored (i.e. not played back). After the unit finishes playback of the last file, playback continues while "<Silent>" is shown on the screen.
Song-Link	You can link any audio files recorded with same FS on a disk (or in an ALE file). Selected files are continuously played back (with no gaps) in order of date/time when each file is added to the ALE file. LTC starts from the LTC start time of the first audio file and jams the LTC of subsequent audio files (therefore, continuous LTC is output). In the Song link mode, you can also select "Stop Mode" from among List-End, Song, Repeat and Off (the default is Off). The Stop mode decides how the unit stops link play. See the next and the following pages for details.
List-Link	You can link any audio files recorded with same FS on a disk (or in an ALE file). Selected files are continuously played back (with no gaps) in order of file number in the ALE file. The unit outputs the original LTC of each audio file, so it is not always continuous. When the unit finishes playing back the last file, it automatically stops.
Mid-Night	This mode is basically the same as the LTC-Link mode, except that the LTC starts running from "12h00m00s00f", crosses "24h00m00s00f" and ends at one frame earlier than "12h00m00s00f" of the next day. Therefore, an audio file which starts from between "00h00m00s00f" and "12h00m00s00f" is linked after "24h00m00s00f".

<Note>: "<Silent>" is shown when no file to be played back exists after the current position on the LTC stream.

<Silent>

Let's assume that the current DVD-RAM disk contains six audio files (including a deleted file, "005") recorded with the same FS, and each audio file has the LTC start time as shown below.

File No.	001	002	003	004	005 (deleted)	006
LTC start time	01h00m00s00f	01h01m00s00f	01h01m25s00f	01h02m00s00f	-	01h03m00s00f
Recording time	30 seconds	30 seconds	30 seconds	30 seconds	-	30 seconds

If you execute list play of these files, they are played back as below.

List play in "LTC-Link" mode

The audio files are played back at their original positions in the LTC stream. When executing list play in this mode, the unit plays back silence in the time code area where no file is played back (between "File 001 and File 002).

File 003 is not played back because its start time overlaps the range of File 002. So there is a 30-second silent area between File 002 and File 004.

The deleted file (005) is not played back so there is a 30-second silent area between File 004 and File 006. After the unit finishes playback of the last file (006), playback continues while "<Silent>" is shown on the screen.

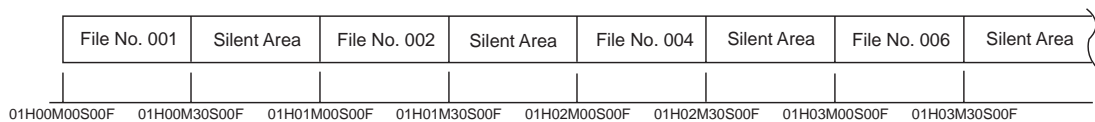

List play in "Song-Link" mode

Files are continuously played back (with no gaps) in order of date/time when each file is added to the ALE file.

All files except the deleted file (005) are played back in order of date/time (i.e. 001 -> 002 -> 003 -> 004 -> 006).

LTC starts from the LTC start time of File 001 and jams the LTC of other audio files. When the "Stop Mode", which can be set only in the "Song-Link" mode, is set to the default (Off), "<Silent>" is shown after finishing playback of the last file. However, depending on "Stop Mode" setting, you can make the unit automatically stop after finishing playback of the last file or repeat playback until you stop.

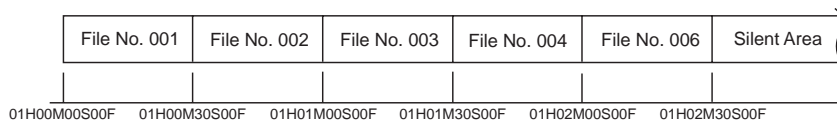

List play in "List-Link" mode

Files are continuously played back (with no gaps) in order of file number in the ALE file (i.e. 001 -> 002 -> 003 -> 004 -> 006). The deleted file (005) is not played back. When each file is played back, LTC recorded on the file is output (so output LTC is not continuous).

Immediately after the unit finishes playback of the last file (006), playback automatically stops.

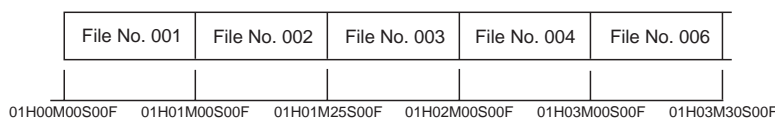

Setting list play mode/Executing list play

Before executing list play, you must set the maximum number of tracks of a file which can be linked and the link mode appropriately.

<Note>: Before making setting for list play, select the FS of audio files to be linked via the quick setup mode or the "Record FS/Bit" menu item in the "SYS SETUP" menu of the MENU mode.

- 1) While the unit is stopped, press the [LIST PLAY/[EDIT EDL]] key.

The display now shows the screen for selecting a play list. If no ALE file exists on the disk, only "<All Link>" is shown (highlighted) in the list as below. If "<All Link>" is selected, all files with the same FS as the "Record FS/Bit" setting can be linked.

```
LIST▶FILE SEL
--Select Play list--
<All Link>
```

<Note>: If ALE files containing audio file entries exists on the disk, the ALE file names are also listed as shown right.

To link audio file entries in an ALE file, use the [MENU] dial to select the desired ALE file name and press the [ENTER/YES] key.

```
LIST▶FILE SEL
--Select Play list--
▶<All Link>
*****.ale
*****.ale
*****.ale
```

<Note>: If "<All Link>" is selected, the unit automatically creates the ALE file which includes all available files on the disk.

- 2) While "<All Link>" is highlighted, press the [ENTER/YES] key.

The display now shows the screen for setting "Link Track (max)" and the "Link Mode". By default, "Link Track (max)" is set to the current "Record tracks" setting, while "Link Mode" is set to "LTC-Link".

```
LIST▶SEL▶MODE
<All Link>
Link Track(max):8trk
Link Mode:LTC-Link
EXECUTE
QUIT
```

- 3) Select the desired link track and link mode.

- "Link Track (max)" setting

This item set the maximum number of tracks of a file which can be linked. By using the [MENU] dial to select "Link Track (max)" and pressing the [ENTER/YES] key, the current setting starts flashing and you can now select the desired maximum number of tracks from among "1trk", "2trk", "4trk", "5trk", "6trk" and "8trk".

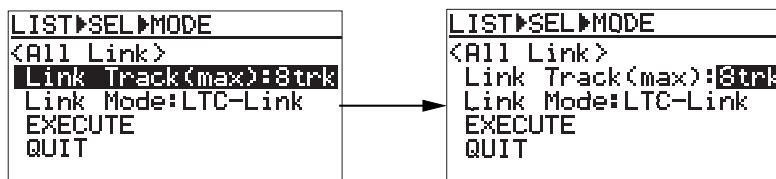

The selected maximum number of tracks is reflected to the "TRACK" field in the status information area on the Home screen.

<Note>: The selected number is the maximum. You can link any file whose number of tracks is equal to or less than the selected number. For example, if you set "Link Track (max)" to "4trk", you can link 2-track and 1-track files, as well as 4-track files.

• "Link Mode" setting

By using the [MENU] dial to select "Link Mode" and pressing the [ENTER/YES] key, the current setting starts flashing.

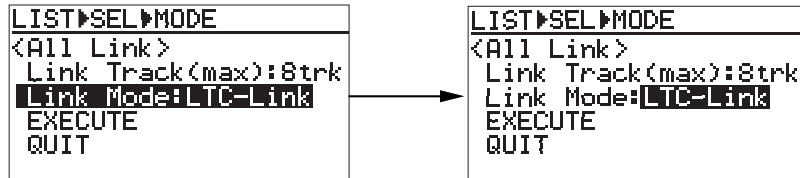

By rotating the [MENU] dial, you can select from among "Song-Link", "List-Link" and "Mid-Night", as well as "LTC-Link". If you select "Song-Link", the "Stop Mode" item is shown on the display (see below). The "Stop Mode" selects how the unit stops link play.

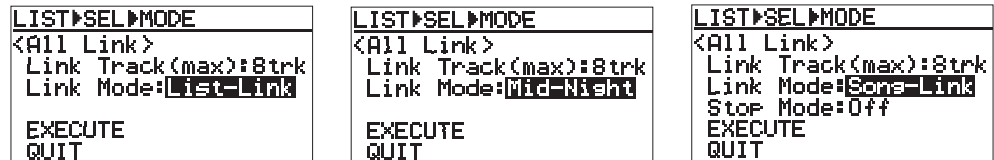

<About "Stop Mode">

When you set "Link Mode" to "Song-Link", you can select the "Stop Mode" from among List-End, Song, Repeat and Off (the default is Off), which decides how the unit stops link play. By selecting "Song-Link" for "Link Mode" and pressing the [ENTER/YES] key, the current option of "Link Mode" starts flashing and you can now select the desired option using the [MENU] dial. After selecting the desired option using the [MENU] dial, press the [ENTER/YES] key to confirm your setting.

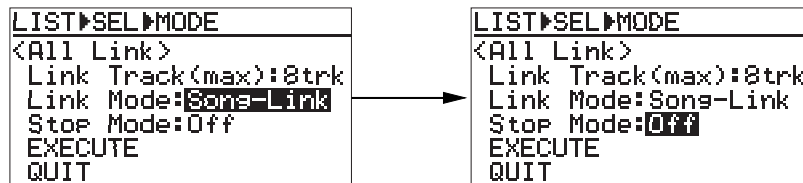

Off	The unit continues playback until it reaches 24H. When it reaches 24H, it stops (default).
List-End	The unit executes seamless playback of files in the list. After finishing playback of the last file in the list, it pauses at the start position of the first file in the list. Pressing the [PLAY] key again starts playback and executes the same as above.
Song	After finishing playback of the first file in the list, it pauses at the start position of the next file in the list. Pressing the [PLAY] key again starts playback and executes the same as above.
Repeat	The unit executes seamless playback of files in the list. After finishing playback of the last file in the list, it starts playback from the first file in the list. The unit repeats playback until you stop.

<Note>: When playing back a file while the link mode is set to "Song-Link", if "CUE 01 (BC\$START)" and "CUE 02 (BC\$END)" are set in a linked file, the unit only plays back the file within the range between "CUE 01 (BC\$START)" and "CUE 02 (BC\$END)".

If you want to play back all data of the file, delete the cues labeled "BC\$START" and "BC\$END" or edit "BC\$START" and "BC\$END" to other labels.

- 4) **Highlight "EXECUTE" and press the [ENTER/YES] key.**
 After "Please wait!" is shown, the play list is created. The display changes to shows the Home screen of the first audio file of the link, while the [LIST PLAY] indicator lights, indicating that the list play mode is now active.

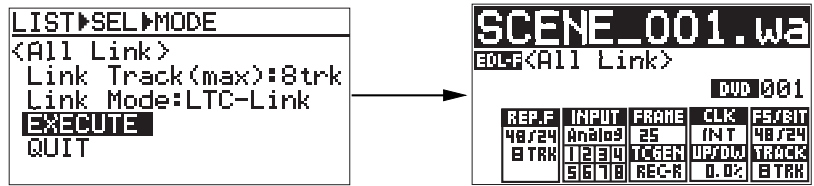

- 5) **Press the [PLAY] key.**
 The unit starts continuous playback according to the selected link mode.

<Note>: While the Home screen above is shown, pressing the [FILE SEL/DRV/PAT] key brings up the screen for selecting the play list, so you can change the play list.

Viewing linked audio files

When the list play mode is active and the unit is stopped, pressing the [SKIP/CURSOR ►►|] or [SKIP/CURSOR |◄◄] key locates to the beginning of a linked audio file. Using this function, you can check which audio files are linked and in which order files are linked.

Locating to the beginning of the play list

When the list play mode is active and the unit is stopped, pressing the [REWIND] key while holding down the [STOP/HOME] key locates to the beginning of the first audio file of the link (Locate ABS 0).

Locating to the end of the play list

When the list play mode is active and the unit is stopped, pressing the [F FWD] key while holding down the [STOP/HOME] key locates to the end of the last audio file of the link (Locate REC END).

Controlling the unit from a video editor

The following describes necessary settings for controlling the DV824 from an external video editor via P2/ES BUSS (RS-422).

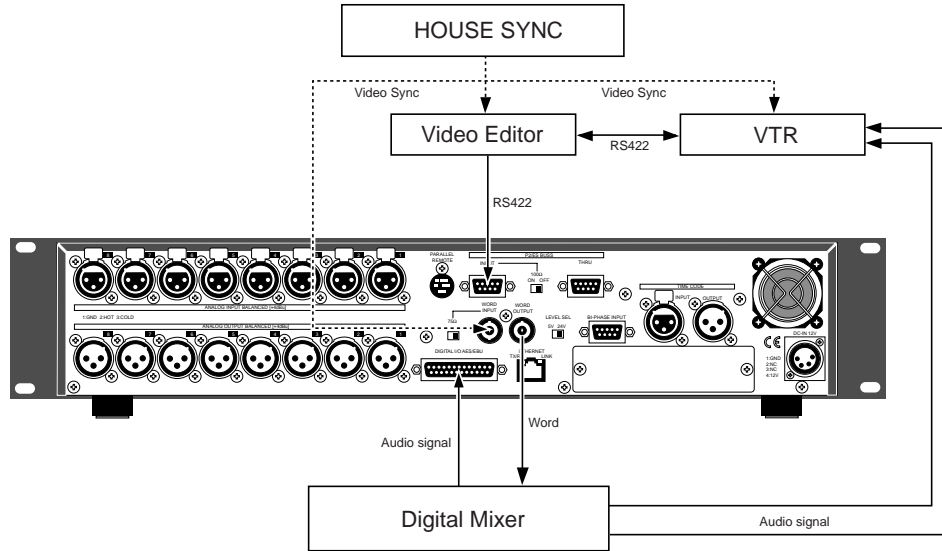

Necessary setting (RS422 SETUP menu)

To control the DV824 from an external video editor, etc., you must make necessary settings via the "RS422 SETUP" menu of the MENU mode by following the procedure below.

- 1) While the unit is stopped, press the [ENTER/YES] key to enter the MENU mode.
- 2) Use the [MENU] dial to select the "RS422 SETUP" menu and press the [ENTER/YES] key.

The display now shows the RS422 menu screen for selecting a menu item.

By using the [MENU] dial to select a desired menu item and pressing the [ENTER/YES] key, you can make setting for the menu item. See the following for details of setting for each menu item.

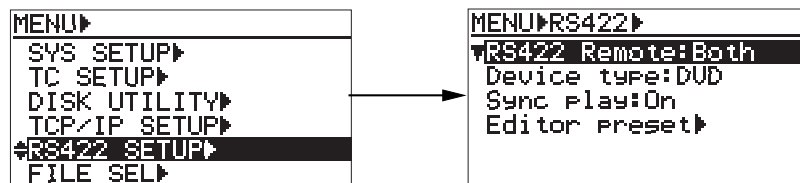

RS422 remote setting (Selection of the device(s) controlling the DV824)

You can select from among "Both" (default), "Local" and "Remote".

Use the [MENU] dial to select the desired option and press the [ENTER/YES] key to confirm your selection.

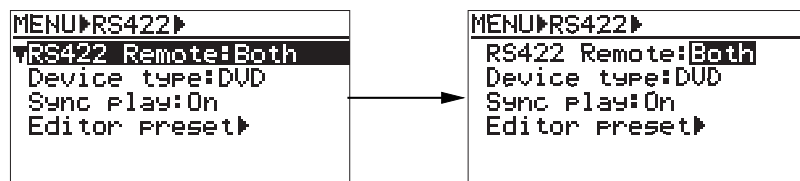

Both	You can control the unit from both panel keys and RS422 remote. This is the default setting.
Local	You can control the unit from panel keys. RS422 remote control is disabled.
Remote	You can control the unit from RS422 remote. Panel key control is disabled.

Device type setting (Selection of the DV824 device type)

You can select between "DVD" (default) and "BVW-75".

Use the [MENU] dial to select the desired device type and press the [ENTER/YES] key to confirm your selection.

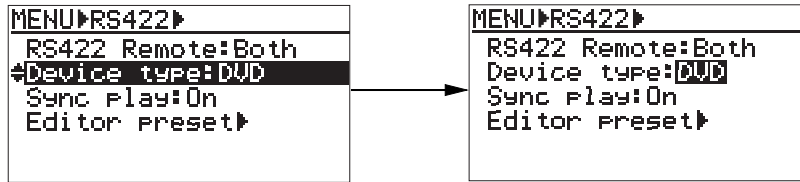

DVD	The device type is set to DV824.
BVW-75	The device type is set to BVW-75.

Sync play setting (On/Off selection of Sync play)

You can select whether or not the unit locks to the incoming video reference when it receives the PLAY command via RS-422 and plays.

Use the [MENU] dial to select "On" or "Off" and press the [ENTER/YES] key to confirm your selection. When connecting an editor to the unit, select "On".

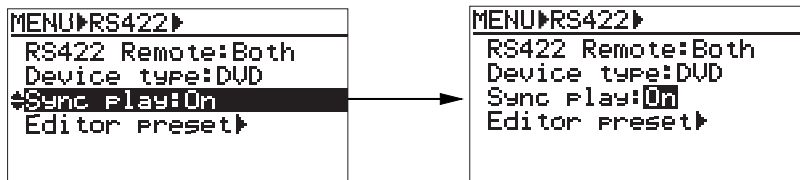

Off	The sync play does not function. The unit does not lock to the incoming video reference.
On	The sync play functions. The unit locks to the incoming video reference.

Editor preset setting (Global setting for editor connection)

You can preset the DV824 to work with an editor in the best condition by setting this item appropriately.

Use the [MENU] dial to select between "Video" and "Lynx" and press the [ENTER/YES] key to confirm your selection.

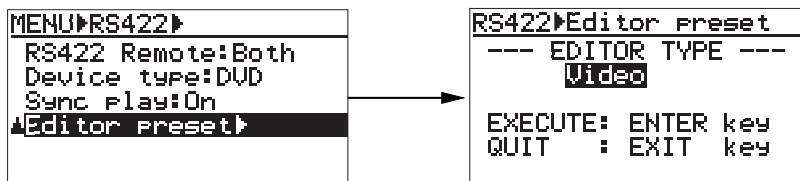

Video	The unit is preset to be controlled by a video editor.
Lynx	The unit is preset to be controlled by the Lynx synchronizer.

- 3) After making settings appropriately, press the [EXIT/NO] key (or the [STOP/HOME] key) to exit the MENU mode.

Setting example of PC connection

The following shows the typical example of connecting a PC to the DV824. It is assumed that a LAN card is installed to the PC and set to work correctly. Note that there may be some difference between the description below and your actual setting.

<Note>: The IP address and sub net mask value shown below are those used in a typical environment. Note that, depending on the computer environment, the DV824 may work correctly by setting a different value or may not work correctly by setting the value shown below.

Connecting DV824 directly to PC

The following procedure shows how to connect the DV824 directly to a PC, without connecting to LAN. It is assumed that the DV824 is connected to the PC using a cross cable.

1) Set the items in the "TCP/IP SETUP" menu of the DV824 MENU mode as below (see page 76 for details).

- IP address: 192.168.0.*** (***) is a desired number between 1 and 254.)
- Sub net mask: 255.255.255.0
- Anonymous: On (Enable)
- Login name: No need to set.
- User password: No need to set.
- TCP/IP Enable: On (Enable)

<Note>: If "Anonymous" is set to "On", the user name and password are not checked when logging in. Therefore, you can log in regardless of the user name and password settings (including blank).

2) Make TCP/IP setting on the PC.

- IP address: 192. 168. 0. *** (***) is a desired value between 1 and 254.)
- <Important!>**: You cannot assign the same IP address as the DV824 IP address.
- Sub net mask: Set the same value as the DV824.
- Default gateway: No need to be set.

<Note>: If it is not clear how to make the TCP/IP setting, see "Help" of your PC for details about the TCP/IP setting.

3) Start up the FTP application of the PC, and make setting for connection.

<Setting of WS-FTP>

- Profile Name: A desired name
- HostName/Address: 192. 168. 0. ### (### must be the same value as the DV824 IP address.)
- HostType: Automatic detect
- Anonymous: Enable (On)
- User ID: Does not need to be set.
- Password: No need to be set.

<Setting of Fetch>

From the "Custom" menu in the menu bar, select "New shortcut" and set the items below.

- Name: A desired name
- Type: Folder
- Server name: 192. 168. 0. ### (### must be the same value as the DV824 IP address.)
- User name/Password: No need to be set.
- Directory: / (slash)

4) **Open the connection with the setting above, and transfer a file.**

<If you use WS-FTP>

Before transferring a file, select "Binary" or "Auto" from among "ASCII", "Binary" and "Auto" shown in the center of the window.

<If you use Fetch>

Before transferring a file, set "Mode" to "Auto" and "Format" to "RawData".

Connecting DV824 to LAN

To connect the DV824 to a LAN, use a straight cable to connect the DV824 to a hub. For details about FTP application setting, see "Connecting DV824 directly to PC" described above.

<Note>: If the IP address or sub net mask is not appropriately set when connecting the DV824 to a LAN, it may give bad influence to the LAN. Consult a network administrator if you need help for setting these items appropriately.

FTP command details

The following shows usable and unusable FTP commands when you can use the DV824 as the FTP server.

<Note>: Only a single user can log in. More than one user cannot log in at the same time.

- The following FTP commands can be used when DV824 works as a FTP server.

USER	Identifying user name.
PASS	Identifying password.
QUIT	Terminating FTP connection. TCP connection for Control is also cut off.
PORT	When transferring data, relay the connection state open port number for data transferring at client side to server. Format: PORT IP1, IP2, IP3, IP4, P1, P2 (IPx: IP address, Px: port number represented by decimal number in every 1 byte unit)
TYPE	Designating data type (ASCII, BECIDIC, BINARY, LOCAL).
RETR	Instructing server to transfer file though data connection.
STOR	Instructing server to write data transferred through data connection into a new file.
LIST	Requesting server to send a list of files.
NLST	Requesting server to send a detailed list of files.
CWD	Changing current directory.
CDUP	Changing current directory to upper level.
PWD	Displaying current directory.
NOOP	Doing nothing.
SYST	Acquire server OS type.

- The following FTP commands cannot be used when DV824 works as a FTP server.

APPE	Instructing server to write data transferred through data connection into an existing file additionally.
DELE	Deleting designated file.
RNFR	Designating current file name for renaming.
RNTO	Changing current file name for renaming.
HELP	Displaying command description.
ACCT	Identifying user account.
PASV	Opening command state designated port except default data port (No, 20) on server.
STRU	Designating file structure.
MODE	Designating file transfer mode (Stream, Block, Compressed).
RMD	Deleting designated directory.
MKD	Creating designated directory.
STAT	Requesting server condition.

TCP/IP SETUP menu setting

To connect the DV824 [ETHERNET] port to a PC. make settings of the "TCP/IP SETUP" menu in the MENU mode appropriately. See below for details of how to make "TCP/IP SETUP" menu settings.

- 1) While the unit is stopped, press the [ENTER/YES] key to enter the MENU mode.
- 2) Use the [MENU] dial to select "TCP/IP SETUP" and press the [ENTER/YES] key.
The display now shows the screen for selecting the menu item.

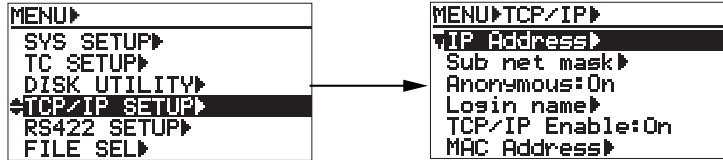

- 3) Use the [MENU] dial to select a desired menu item and press the [ENTER/YES] key.
You can now edit the menu item (see below for details).

• IP address setting

The "IP Address" menu item sets the IP Address on DV824.

By selecting "IP Address" and pressing the [ENTER/YES] key, the current IP address is shown (by default, "192. 168. 1. 188.").

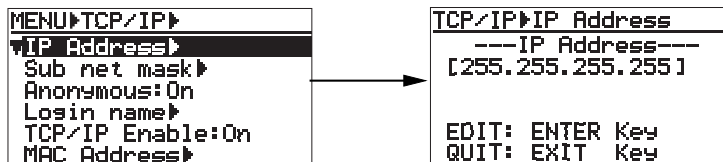

By pressing the [ENTER/YES] key again, the leftmost three-digit number starts flashing. You can now enter the desired value using the [MENU] dial (or alphanumeric keys), while you can move the cursor using the [SKIP/CURSOR |<<>>|] key.

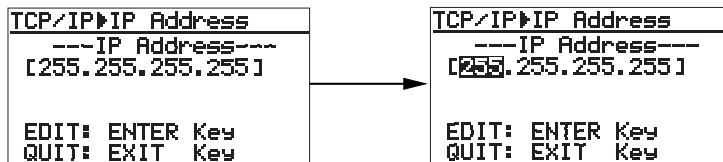

After completing editing, press the [ENTER/YES] key to confirm the setting.

• Sub net mask setting

The "Sub net mask" item sets the sub net mask value in the network DV824 exists. In the case the Sub net mask is not used, you do not have to set this value.

By selecting "Sub net mask" and pressing the [ENTER/YES] key, the current Sub net mask is shown (by default, "255. 255. 255. 0.").

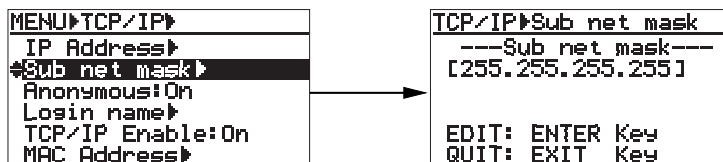

By pressing the [ENTER/YES] key again, the leftmost three-digit number starts flashing. You can now enter the desired value using the [MENU] dial (or alphanumeric keys), while you can move the cursor using the [SKIP/CURSOR |<<>>|] key.

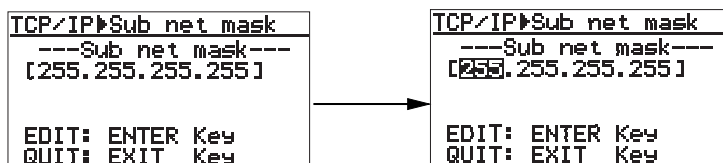

After completing editing, press the [ENTER/YES] key to confirm the setting.

• Anonymous on/off setting

The "Anonymous" menu item sets the anonymous On/Off. By selecting "Anonymous" and pressing the [ENTER/YES] key, the current setting is shown (by default, "On"). While the DV824 is connected to a PC and used as an FTP server, if "Anonymous" is set to "On", you do not need to set the login name and password.

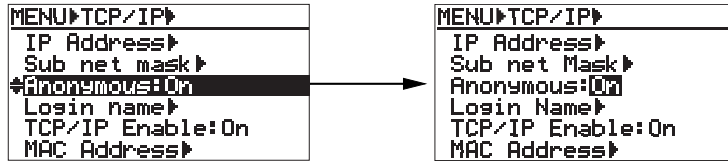

After selecting "On" or "Off" using the [MENU] dial, press the [ENTER/YES] key to confirm the setting.

• Login name/password setting

The "Login name" menu item sets the login name (user name) and password. Using the Login name and the Password set in this menu item, you can log in from an FTP client application. By default, both "Login name" and "Password" fields are blank. In this condition, you can log in. By selecting "Login name" and pressing the [ENTER/YES] key, the display shows the screen for setting the login name and password (by default, both fields are blank).

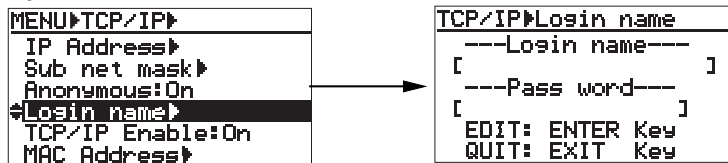

By pressing the [ENTER/YES] key again, you can now edit the login name. After entering the desired name using the [MENU] dial (or alphanumeric keys), press the [ENTER/YES] key to confirm the setting. Now you can enter the password. Enter the desired password in the similar way as above, and press the [ENTER/YES] key to confirm the setting.

• TCP/IP Enable mode on/off setting

The "TCP/IP Enable" menu item selects FTP commands enabled ("On") or disabled ("Off"). By selecting "TCP/IP Enable" and pressing the [ENTER/YES] key, the current setting ("On" or "Off") is shown (by default, "On").

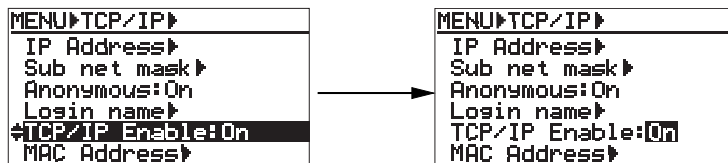

After selecting "On" or "Off" using the [MENU] dial, press the [ENTER/YES] key to confirm the setting.

• Mac address checking

The MAC (Machine Access Control) address can be checked but not changed. By selecting "MAC address" and pressing the [ENTER/YES] key, the MAC address assigned to the DV824 is shown. It can be checked but not changed.

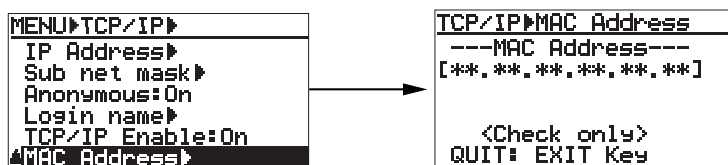

Press the [EXIT/NO] key to exit the screen for showing the MAC address.

File transfer example between the DV824 and a PC

The following shows the procedure example of transfer an audio file using the "WS FTP" Windows FTP client application (see the instructions of the FTP application for details).

- 1) **Start up the "WS FTP" application.**

The "Session Properties" dialog box in which current settings such as "IP address" are shown appears.

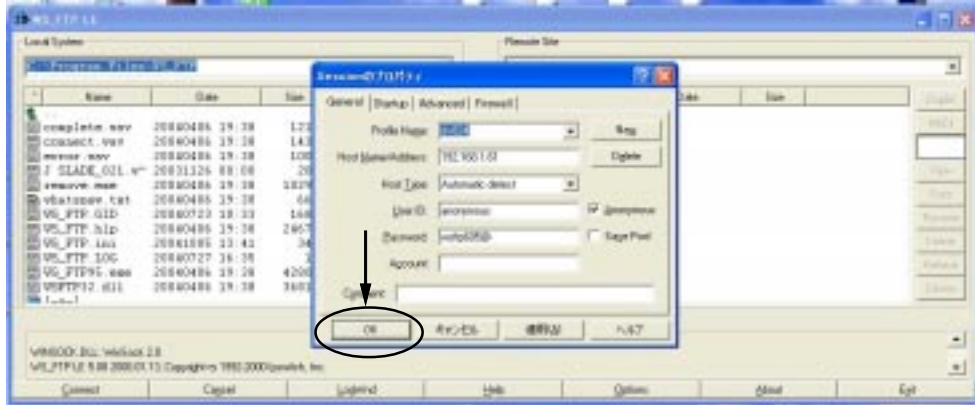

- 2) **Click on "OK" in the "Session Properties" dialog box.**

You can now see the DV824 drive (and the partitions of the optional hard disk drive if it is installed) in the right window, as below.

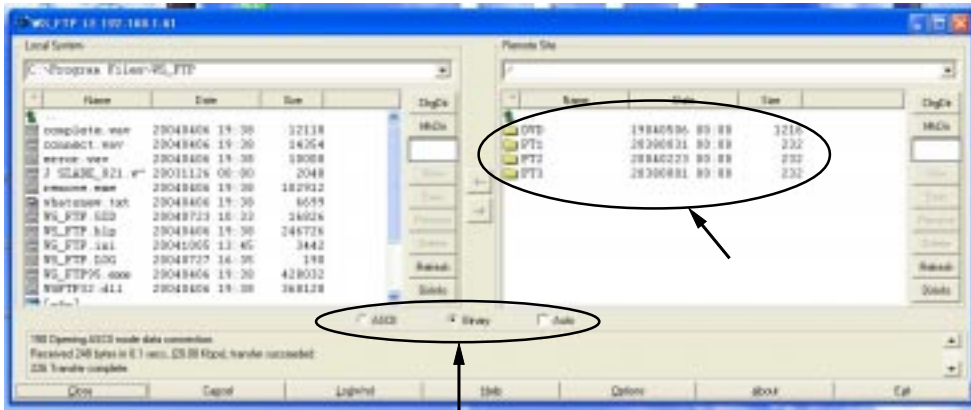

Select Binary or Auto.

- 3) **Click on the desired drive.**

In the window example below, partition (PT1) of the optional hard disk opens and the "bwff" folder is shown.

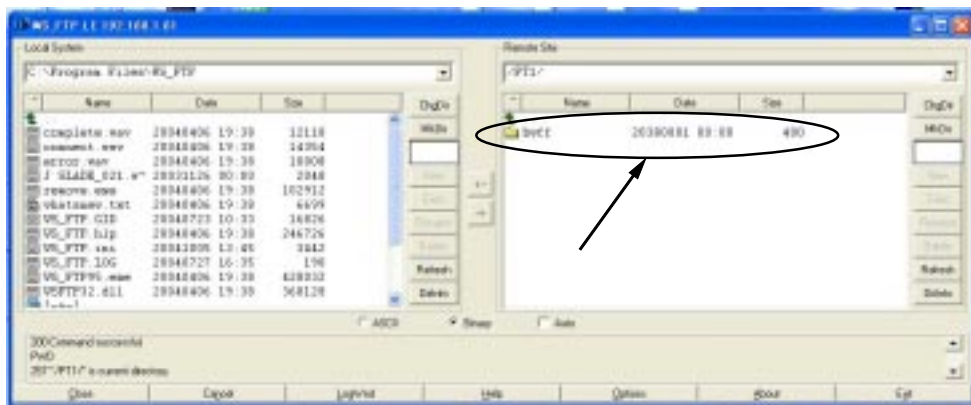

4) **Click on the "bwf" folder.**

As shown in the window example below, audio files recorded in the selected partition are shown under the Info. folder.

You can now transfer an audio file from the DV824 to the PC or vice versa.

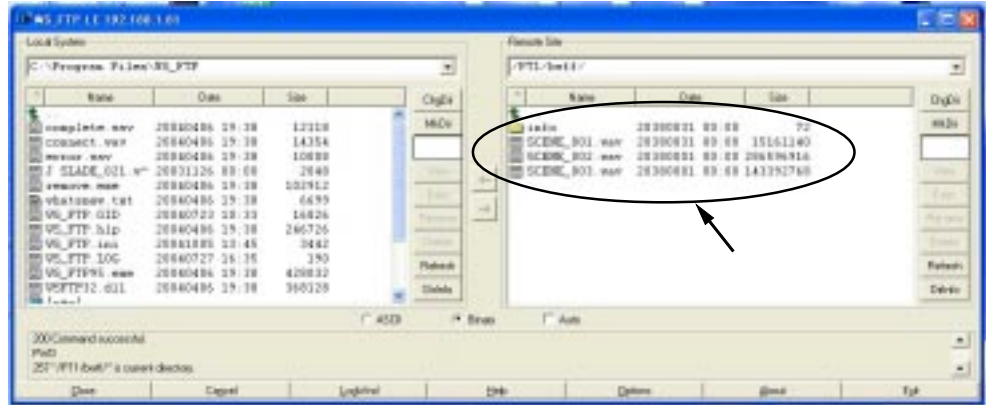

• **Transferring an audio file from the DV824 to the PC**

Highlight an audio file in the right window (for the DV824) and click on "<". The selected audio file is transferred from the DV824 (right window) to the PC (left window).

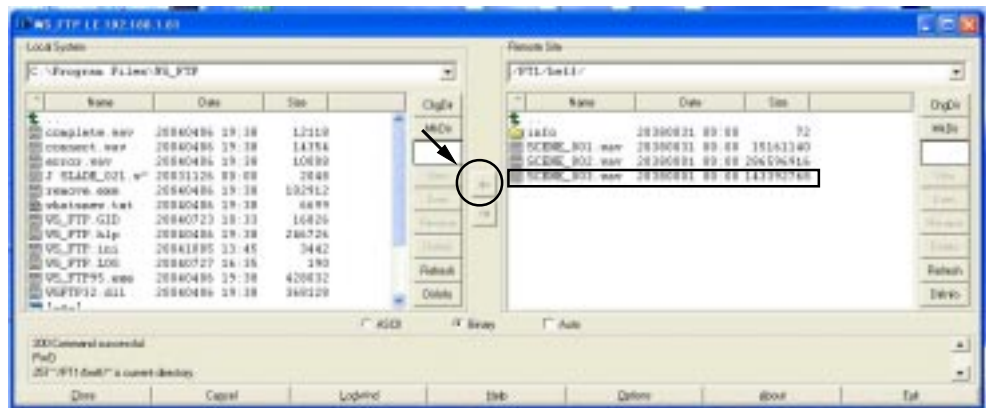

• **Transferring an audio file from the PC to the DV824**

Highlight an audio file in the left window (for the PC) and click on ">". The selected audio file is transferred from the PC (left window) to the DV824 (right window).

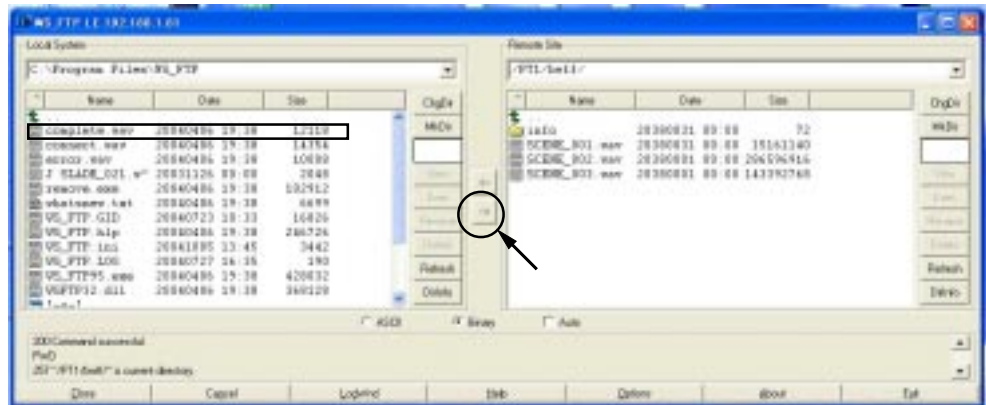

Time code recording/playback (the optional Model 8348 required)

Recording time code

By installing the optional TC/SYNC card (Model 8348) to the DV824, you can record time code generated by the internal TC generator along with audio signals, or record incoming external time code. Furthermore, you can record internal generator time code which jams to external time code.

<Note>: You can make settings for time code recording/playback via the "TC SETUP" menu on the MENU mode. See page 125 for details.

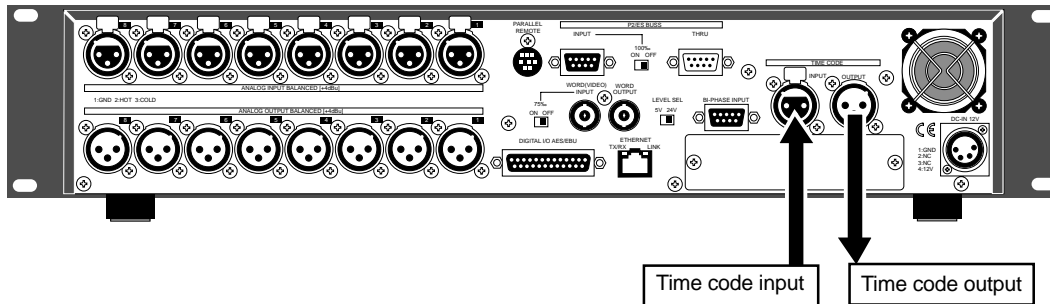

Frame rate setting

You can select the desired frame rate via the quick setup mode, as described on page 46. (You can also select the frame rate via the "Frame Rate" menu item in the "TC SETUP" menu of the MENU mode. See page 127.)

<Note>: When recording external time code, you can view time value and frame rate of external time code by selecting the time mode to "TC IN" using the [TIME SEL] key.

TC generator mode setting

Depending on the TC generator mode, the unit records time code differently.

You can select the desired TC generator mode via the quick setup mode, as described on page 47. (You can also select the TC generator mode via the "Gen Mode" menu item in the "TC SETUP" menu of the MENU mode. See page 128 for details.) The following four generator modes are available.

24H Run	When recording, the unit records time code based on the current internal RTC (real-time clock) time.
Rec Run	When recording, the unit records time code which continues from the last time code value of the previous audio file. If you change to a new disk which does not have any audio file and make recording, the unit records time code which continues from the last time code value of the most recent audio file on the disk previously set.
Free Run	When recording, the unit records time code generated by the internal generator which runs freely.
EXT Run	When recording, the unit records the incoming external time code.

Playing back time code

During playback, time code recorded on an audio file is played back together with audio signals and output from the [TIME CODE OUTPUT] connector provided with the optional TC/SYNC card. The playback time code value is shown on the display when the time mode is set to "LTC".

Time code output setting

You can select the time code source fed from the [TIME CODE OUT] connector between "Repro" (playback time code) or "Gen" (generator time code) via the "Sel. TC Out" menu item in the "TC SETUP" menu of the MENU mode. The default is "Gen". **See page 131 for details.**

<Note>: When the "Sel. TC Out" menu item in the "TC SETUP" menu of the MENU mode is set to "Gen", the [TIME CODE OUTPUT] connector outputs time code generated by the internal TC generator.

<Note>: While "Sel. TC Out" is set to "Gen", generator time code is output in the following conditions:

- When "Gen Mode" is set to "Free Run".

If necessary, the following menu items in the "TC SETUP" menu should be appropriately set.

<Menu items which affect time code output>

- 1) "Edit LTC Start" menu item (for LTC start time setting). **See page 132.**
- 2) "Rep Pause TC" menu item (for TC output while paused). **See page 134.**
- 3) "Rep TC Ubit" menu item (for userbit setting of playback time code). **See page 133.**

Jam function (the optional Model 8348 required)

The jam function of the DV824 internal generator allows taking over generating time code after the generator locks to the external time code timing.

Using the jam function, even if time code connection is cut after lock is achieved, the DV824 time code generator can run with extreme accuracy (its own crystal accuracy). Therefore, the DV824 can stripe time code in sync with the separated external machine.

To execute the jam function, the following condition must be satisfied.

- 1) External TC is fed to the [TIME CODE INPUT] connector which is provided with the optional TC/SYNC card.
- 2) The frame rate matches between external TC and the DV824.
- 3) "Gen Mode" is set to "Free Run" (**see page 128 for details**).

* The time display mode is set to "TC IN" and external TC value is shown.

<Note>: If you are going to jam the external time code into the generator while the frame rate of external time code does not match the DV824 frame rate, "Illegal Frame!" is shown on the display for warning.

If you are going to initiate the jam function while external time code is not normally fed to the DV824, "Void LTC in!" is shown on the display for warning.

Executing jam function

The following describes how to execute the jam function.

- 1) While the unit is stopped, press the [ENTER/YES] key to enter the MENU mode.

The unit enters the MENU mode and the MENU list screen.

```

MENU▶
SYS SETUP▶
TC SETUP▶
DISK UTILITY▶
TCP/IP SETUP▶
RS422 SETUP▶
FILE SEL▶
    
```

- 2) Use the [MENU] dial to select "TC SETUP" and press the [ENTER/YES] key.

The display now shows the TC SETUP menu screen.

```

MENU▶
SYS SETUP▶
TC SETUP▶
DISK UTILITY▶
TCP/IP SETUP▶
RS422 SETUP▶
FILE SEL▶
    
```

→

```

MENU▶TC SETUP▶
Sync clock:INT
Frame rate:25
Gen mode:Rec Run
Set Gen.TC▶
Force JAM▶
JAM mode:BOTH
    
```

- 3) Use the [MENU] dial to select the "Force JAM" menu item and press the [ENTER/YES] key.

The display now shows the Force JAM screen, where time value and userbit information of the external TC and generator TC is shown.

```

MENU▶TC SETUP▶
Sync clock:INT
Frame rate:25
Gen mode:Rec Run
Set Gen.TC▶
Force JAM▶
JAM mode:BOTH
    
```

→

```

TC▶Force JAM
TC IN:***h***m***s***f
Ubit :## ## ## ##
GEN :***h***m***s***f
Ubit :## ## ## ##
JAM :ENTER/YES Key
Quit :EXIT/NO Key
    
```

- 4) Press the [ENTER/YES] key to execute the jam function.

The external time code is jammed into the internal time code, and the jammed time code is counted up.

By default, both the time value and userbit of the external time code are jammed. However, via the "JAM mode" menu item in the "TC SETUP" menu, you can change this setting to jamming only the time code value or only the userbit (see page 130 for details).

- 5) To exit the jam function, press the [EXIT/NO] key.

Auto copy function (the optional Model 9057 required)

When recording to an audio file on a partition of the Model 9057 optional hard disk drive, the auto copy function automatically copies the same audio file to a DVD-RAM disk. You can select the auto copy mode between the following two auto copy modes.

Immediately mode	<p>Copy recording to a DVD-RAM disk is executed simultaneously when recording to a hard disk partition. The recording size of a take is limited to the capacity of the hard disk partition or DVD-RAM disk.</p> <p><Note>: In this mode, if no DVD-RAM disk is set, the DV824 cancels the auto copy mode and returns to the normal recording mode.</p>
Background mode	<p>Immediately after the DV824 ends recording to the partition and stops, the copy starts. In this mode, even if no DVD-RAM disk is set when starting recording, you can start copying by setting a disk later.</p> <p><Note>: If you turn off the DV824 before setting a DVD-RAM disk, the copy data is erased.</p>

<Note>: While the auto copy mode is "On" and a DVD-RAM disk is set to the DVD-RAM drive, if the partition you are going to record to is formatted in the "DDR" mode (for dual drive recording), dual recording takes priority to auto copy.

<Note>: Editing the name or meta data of the file on the partition does not reflect to the data on the DVD-RAM disk.

<Note>: Auto copy cannot be canceled by False start.

Selecting auto copy mode

The following procedure is assumed that a recordable DVD-RAM disk is set to the DVD-RAM drive.

1) Select a partition to which audio data is recorded.

By pressing the [SHIFT] key to turn on the [SHIFT] indicator followed by the [FILE SEL/[DRV/PAT]] key, the display shows the "DRIVE SEL" screen.

In this screen, "DVD" represents the DVD-RAM drive, while "PT01" through "PT08" represent the hard disk partitions.

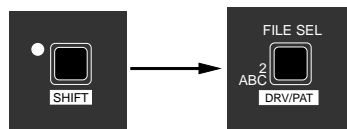

DRIVE SEL
[DRU] [~REEL~]
▼ DVD [S001]
PT01 [S002]
PT02 [S003]
PT03 [S004]
PT04 [S005]

<Note>: The optional hard disk drive is formatted when it is installed by the Fostex service section, and divided into eight partitions. Each partition reserves 4.7GB recording space.

By using the [MENU] dial to select the desired partition and pressing the [ENTER/YES] key, the display changes to show the Home screen for the selected partition. If no file is recorded to the partition, "-No files!" is shown as below.

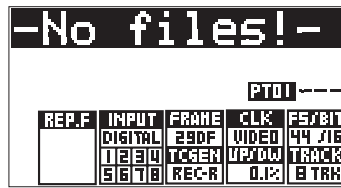

- 2) While the unit is stopped, press the [ENTER/YES] key to enter the MENU mode. The display now shows the MENU list screen.



- 3) While "SYS SETUP" is highlighted, press the [ENTER/YES] key. The display now shows the SYS SETUP menu screen.

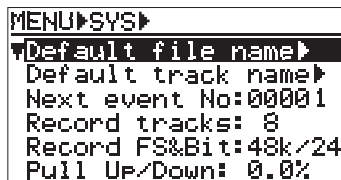

- 4) Use the [MENU] dial to select the "Auto copy" menu item and press the [ENTER/YES] key. The current setting flashes and you can now select the desired auto copy mode. By default, "Off" flashes.

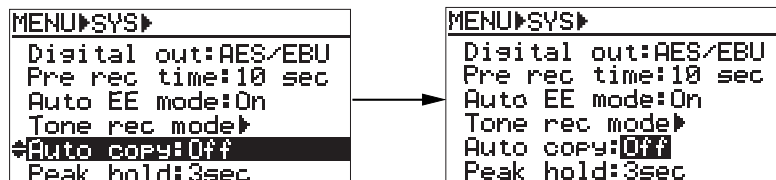

You can select from among "Off", "BGRD (Background)" and "IMME" (Immediately).

- 5) Use the [MENU] dial to select the desired option and press the [ENTER/YES] key. After the display shows "Setup auto copy" followed by "Ready auto copy", the selected mode is set. The setting is stored to the DV824 flash ROM. In this procedure example, it is assumed that "IMME" (Immediately) is selected.

- 6) Press the [STOP/HOME] key to exit the MENU mode. The display now shows the Home screen for the partition. According to the copy mode selection in step 5) above, "IM" icon (when selecting "IMME") or "BG" icon (when selecting "BGRD") is shown on the left of the status information area.

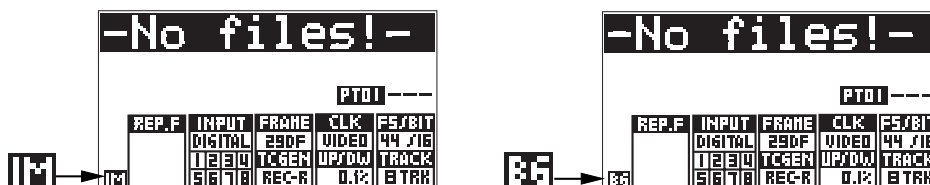

Making auto copy

- 1) Press the [SAFE/RDY] key to make the unit record ready (the [SAFE/RDY] indicator flashes).

By making the unit record ready while the auto copy mode is active, the copy source (partition) remaining time and copy destination (DVD-RAM disk) remaining time is alternately shown.

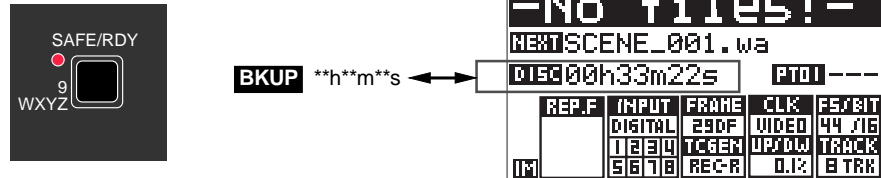

- 2) Press the [RECORD] key to start recording to the partition.

When the auto copy mode is set to "IMME", audio data is recorded to the partition, while it is copied to the DV824 DVD-RAM disk.

- 3) Press the [STOP/HOME] key to stop recording.

If you choose the "BGRD" (Background mode) in step 4) and execute recording, auto copy actually starts when pressing the [STOP/HOME] key to stop recording. When starting auto copy, "Backup Copy start!" is shown on the display for a few seconds, and immediately after auto copy finishes, "Backup Copy Finished!" is shown.

In the "BGRD" (background) mode, even if no DVD-RAM disk is set, the DV824 makes recording to the partition. In such a case, the copy data remains internally after recording to the partition finishes, therefore, auto copy is executed when setting a blank DVD-RAM disk.

<Note>: If you execute auto copy without setting a copy destination (blank DVD-RAM) disk, the copy data remains until turning off the unit. However, once you turn off the unit, the copy data is erased and the unit does not execute auto copy.

<Note>: If you do not need to make auto copy, set the "Auto copy" menu item back to "Off".

Disk copy function (the optional Model 9057 required)

The disk copy function fully copies all audio files recorded on a DVD-RAM disk (or hard disk partition) to another DVD-RAM disk (or hard disk partition).

To execute the disk copy function, use the "Disk copy" menu item in the "DISK UTILITY" menu of the MENU mode.

Making disk copy

The following procedure is assumed that the DVD-RAM drive is selected and an audio file on a DVD-RAM disk is loaded.

- 1) While the unit is stopped, press the [ENTER/YES] key to enter the MENU mode. The display now shows the MENU list screen.

```

MENU▶
SYS SETUP▶
TC SETUP▶
DISK UTILITY▶
TCP/IP SETUP▶
RS422 SETUP▶
FILE SEL▶
  
```

- 2) Use the [MENU] dial to select "DISK UTILITY" and press the [ENTER/YES] key. The display now shows the DISK UTILITY menu screen.

```

MENU▶
SYS SETUP▶
TC SETUP▶
DISK UTILITY▶
TCP/IP SETUP▶
RS422 SETUP▶
FILE SEL▶
  
```

→

```

MENU▶DISK UTILITY▶
Edit file name▶
File info.▶
Delete file▶
Restore Del. file▶
Optimize disk▶
Format▶
  
```

- 3) Use the [MENU] dial to select "Disk copy" and press the [ENTER/YES] key. The display now shows the screen for selecting the copy destination (DVD-RAM drive or partition).

```

MENU▶DISK UTILITY▶
Reel No:[S001 ]
Rec Protect:Off
Resume:Off
Part.Protect:Off
File copy▶
Disk copy▶
  
```

→

```

UTILITY▶Disk Copy
-Select Destination-
SourceDrive: DVD
Destination: PT01 HD
  
```

- 4) Use the [MENU] dial to select the copy destination (DVD-RAM drive or partition) and press the [ENTER/YES] key.

The display shows the "CAUTION" message on which "Are you sure?" flashes, as shown below.

In the bottom of this message screen, the approximate time required for disk copy is shown.

```

---CAUTION---
If ENTER key is push
-ed, will start Disk
Copying and delete
PT01 HD area data.
Are you sure?
Finish time:01M13S
  
```

<Note>: You cannot select the disk copy destination to the same medium as the copy source. If you do so, the display shows "Void!" and returns to the screen for selecting the copy destination medium.

5) **If you are sure, press the [ENTER/YES] key.**

The DV824 starts disk copy to the selected destination medium.

During disk copy, the display shows estimated time and space remaining progress indication for disk copy.

When disk copy completes, "Completed!" is shown on the display and the DV824 stops disk access.



6) **Press the [STOP/HOME] key to exit the MENU mode.**

The display shows the Home screen for the copy source medium.

File copy function (the optional Model 9057 required)

The disk copy function copies an audio file recorded on a DVD-RAM disk (or hard disk partition) to another DVD-RAM disk (or hard disk partition).

To execute the disk copy function, use the "File copy" menu item in the "DISK UTILITY" menu of the MENU mode.

Making file copy

The following procedure is assumed that the DVD-RAM drive is selected and an audio file on a DVD-RAM disk is loaded.

1) **While the unit is stopped, press the [ENTER/YES] key to enter the MENU mode.**

The display now shows the MENU list screen.



2) **Use the [MENU] dial to select "DISK UTILITY" and press the [ENTER/YES] key.**

The display now shows the DISK UTILITY menu screen.

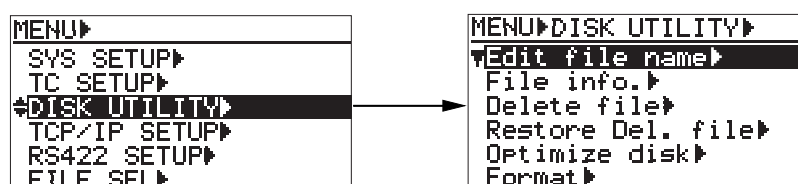

- 3) Use the [MENU] dial to select "File copy" and press the [ENTER/YES] key.
The display now shows the screen for selecting the copy destination (DVD-RAM drive or partition).

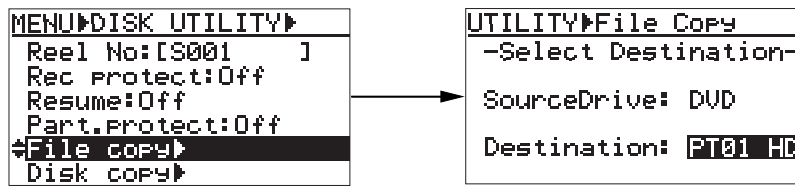

- 4) Use the [MENU] dial to select the copy destination (DVD-RAM drive or partition) and press the [ENTER/YES] key.
The display now shows the screen for selecting the desired audio file from those recorded on the current medium.



<Note>: You cannot select the file copy destination to the same medium as the copy source. If you do so, the display shows "Void!" and returns to the screen for selecting the copy destination medium.

- 5) Use the [MENU] dial to select the desired audio file(s) to be copied, and press the [FILE SEL] key.
The audio file to be copied is selected and a checkmark is placed to the left of its name. You can select more than one audio file by repeating the operation above.

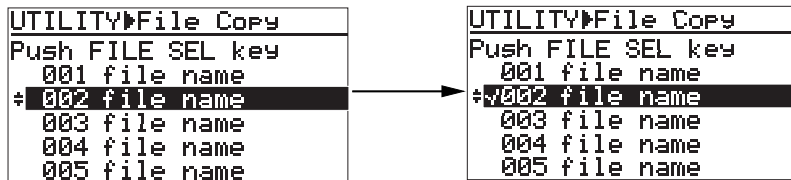

To deselect an audio file, select the file with a checkmark and press the [FILE SEL] key again (on the screen example below, audio file 002 is selected).

- 6) After making audio file selection, press the [ENTER/YES] key.
The DV824 starts file copy to the destination medium (disk or partition). During file copy, the display shows estimated time and space remaining progress indication for file copy. When file copy completes, "Completed!" is shown on the display and the DV824 stops disk access.

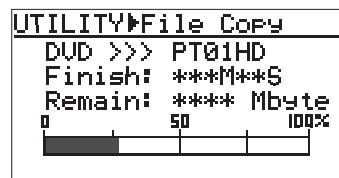

<Note>: If the available recording space of the copy destination is smaller than the copy source size, "Over copy size!" is shown and the display returns to the previous screen for selecting an audio file.

- 7) Press the [STOP/HOME] key to exit the MENU mode.
The display shows the Home screen for the copy source medium.

Dual drive recording (the optional Model 9057 required)

Dual drive recording is a special function which simultaneously records the same data to a "mirror" DVD-RAM disk (*) while recording audio data to a hard disk partition specially formatted for "dual drive recording".

Dual drive recording intends to make a clone disk.

Therefore, editing meta data or disk volume label (reel No.) of an audio file recorded to a hard disk partition is reflected to a "mirror" DVD-RAM disk.

(*) About "mirror" disk

A DVD-RAM disk which is the partner of the current drive formatted for "dual drive recording" is called a "mirror disk".

When formatting the DV824 internal hard disk partition for "dual drive recording", a DVD-RAM disc set to the DVD-RAM drive is automatically assigned as a "mirror disk". Therefore, when making dual drive recording, the "mirror disk" must be set to the drive.

<Note>: You cannot record data only to the mirror disk.

To make it possible to record data only to the mirror disk, reformat the current hard disk partition for normal recording via the "Format" menu item in the "DISC UTILITY" menu of the MENU mode.

The following explains how to format a partition for dual drive recording and how to make dual drive recording.

Formatting in the "DDR" mode

To carry out dual drive recording, you have to format the current partition in the "DDR" mode for dual drive recording. The following procedure is assumed that the "PT02HD" hard disk partition is currently selected (see **page 83** for details about how to select a partition).

- 1) While the unit is stopped, press the [ENTER/YES] key to enter the MENU mode. The display now shows the MENU list screen.

```

MENU▶
SYS SETUP▶
TC SETUP▶
DISK UTILITY▶
TCP/IP SETUP▶
RS422 SETUP▶
FILE SEL▶
  
```

- 2) Use the [MENU] dial to select "DISK UTILITY" and press the [ENTER/YES] key. The display now shows the DISK UTILITY menu screen.

```

MENU▶
SYS SETUP▶
TC SETUP▶
DISK UTILITY▶
TCP/IP SETUP▶
RS422 SETUP▶
FILE SEL▶
  
```

→

```

MENU▶DISK UTILITY▶
Edit file name▶
File info.▶
Delete file▶
Restore Del. file▶
Optimize disk▶
Format▶
  
```

- 3) Use the [MENU] dial to select "Format" and press the [ENTER/YES] key.
The display now shows the screen for format setting.

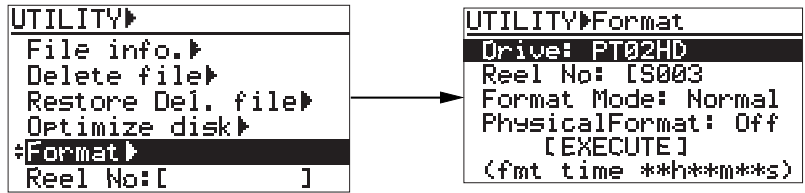

We assume to use the default reel number (volume label) which is "S003", and skip to the format mode selection.
(If you want to change the reel number later, you can do it using the "Reel No" menu item in the "DISK UTILITY" menu of the MENU mode.)

- 4) Use the [MENU] dial to select "Format Mode" and press the [ENTER/YES] key.
The current format mode ("Normal" on the screen below) flashes. You can now select the desired mode.

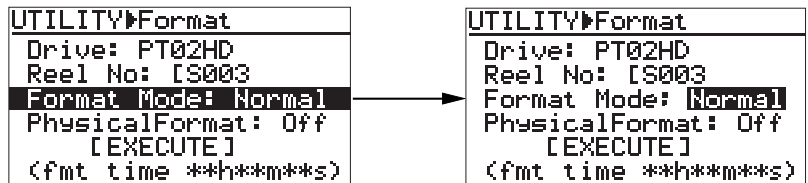

- 5) Use the [MENU] dial to select "DDR" and press the [ENTER/YES] key.
The format mode is set to "DDR" and "EXECUTE" is highlighted.

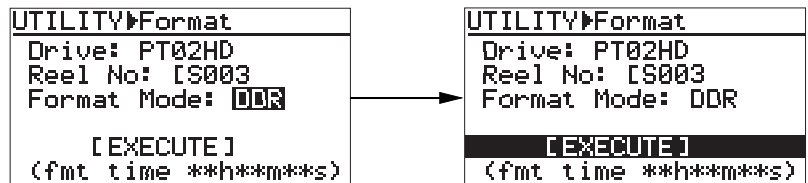

- 6) While "EXECUTE" is highlighted, press the [ENTER/YES] key.
The display shows the caution message before executing formatting.
As this caution message tells you, if you format partition 2 (PT02) in the "DDR" mode, the DVD-RAM disk which is assigned as a "mirror disk" is also formatted and all data on the DVD-RAM disk and partition 2 are erased.



- 7) If you are sure, press the [ENTER/YES] key to execute formatting.
The display now shows the formatting progress indication. When formatting completes, "Fmt.Completed!" is shown.

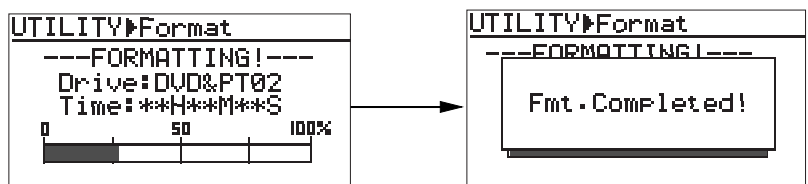

8) **Press the [STOP/HOME] key to exit the MENU mode.**

After exiting the MENU mode, the display returns to the Home screen of the current partition, while the DV824 scans the mirror disk.

On the Home screen, you can see "DDR" beside the name of the partition, as shown below.

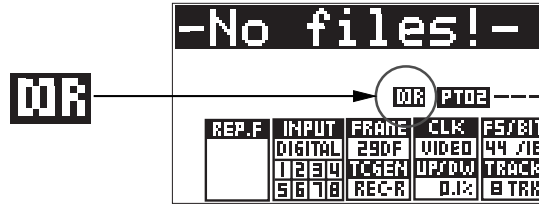

Now you are ready for dual drive recording.

Making dual drive recording

The following procedure is assumed that the selected partition (PT02) is "DDR" formatted and a mirror disk is set to the DVD-RAM drive.

<Note>: To execute dual drive recording, you must set a mirror disk to the DVD-RAM disk drive. If a wrong disk is set to the DVD-RAM disk drive or no disk is set, the DV824 detects an error when scanning the mirror disk, and shows a caution message ("Difference! DDR mirror disk", etc.). When it scans a correct mirror disk, "Presence! DDR mirror disk" is shown.

<Note>: When starting dual drive recording, if the current drive is "Normal" formatted, switch to a "DDR" formatted hard disk partition and set a mirror disk to the DVD-RAM drive. On the screen for selecting a drive, "DDR" is placed on the right of the name of the "DDR" formatted partition. So you can easily distinguish them.

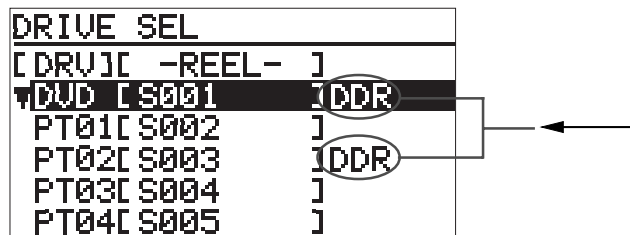

1) **Start recording to partition 2 ("PT02").**

Dual drive recording starts. The DV824 also make recording to the mirror disk in the background, as well as recording to partition 2 ("PT02").

2) **After completing recording, press the [STOP/HOME] key to stop recording.**

If recording has not been successfully made, immediately cancel by the False start function and make recording again.

Chasing external TC (the optional Model 8348 required)

The following explains how to chase-sync the unit to time code received from the [TIME CODE INPUT] connector when the optional TC/SYNC card (Model 8348) is installed.

In the following connection example, a VTR is a master, while the DV824 (with the Model 8348) is a slave. The DV824 receives time code recorded on the master VTR and chase the master. A word sync reference signal is also fed to the DV824 from the master VTR.

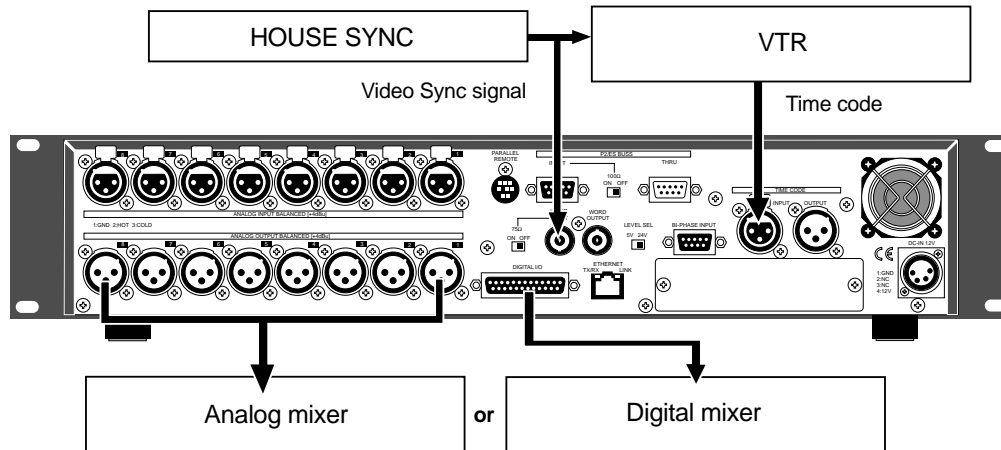

Preparations

Before performing the chase function, set the following.

- 1) **Set the system clock reference to "Video".**
You can set the system clock reference via the quick setup mode or the "Sync clock" menu item in the "TC SETUP" menu of the MENU mode (see pages 47 and 127).
- 2) **Set the chase mode appropriately.**
You can set the chase mode via the "Chase mode" menu item in the "TC SETUP" menu of the MENU mode (see page 135). Three chase modes ("Once", "Continue" and "Frame sync") are available. The default is "Once".
- 3) **Set chase offset if required.**
By setting chase offset appropriately, the unit chases and locks to the master with maintaining a time interval.
You can set chase offset via the "Chase offset" menu item in the "TC SETUP" menu of the MENU mode (see page 136).

Chasing

- 1) **Starts playback of the master (in this example, VTR).**
- 2) **Press the DV824 [CHASE] key to activate the chase mode (the [CHASE] indicator starts flashing).**
The DV824 chases the master time code. When lock is achieved, it starts playback while the [CHASE] indicator is lit steadily.
- 3) **To stop chasing, press the [CHASE] key again (the [CHASE] indicator turns off).**

Data export to PC (the optional Model 8370 required)

By installing the optional IEEE1394/USB card (Model 8370) and connecting the DV824 to a personal computer via the [IEEE1394] (or [USB]) connector, audio file data can be transferred between the DV824 and a personal computer. DV824 audio data can be copied to a hard disk on the personal computer, or exported to a software application such as Digidesign Pro Tools.

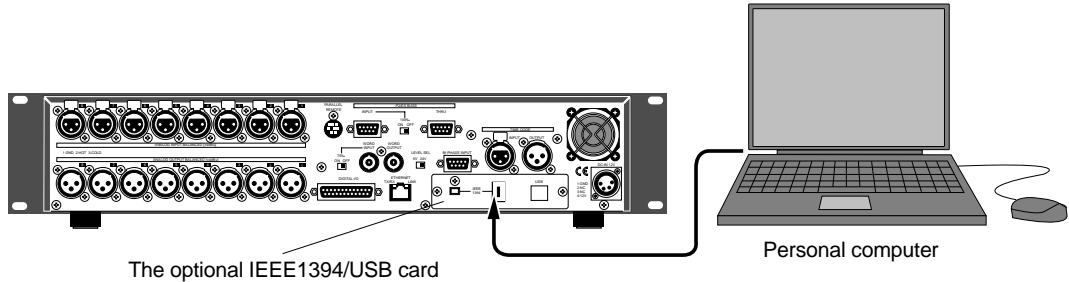

<Note>: To export audio file data to your PC, install the dedicated driver (on the CD-ROM) supplied with the optional IEEE1394/USB card or a commercially available DVD-RAM writing software application to your PC. Also note that even if appropriate writing software is correctly installed, the read/write functions are limited depending on OS, as below.

When connecting via the [USB] port:

- **Windows XP, Windows 2000**
Both "Read" and "Write" are possible (when the supplied driver is used).
- **Macintosh OSX, OS9.2.1, OS9.2.2**
Only "Read" is possible (when the supplied driver or a commercially available writing software is not used).

When connecting via the [IEEE1394] port:

- **Windows XP, Windows 2000, Windows ME, Windows 98SE**
Both "Read" and "Write" are possible (when the supplied driver is used).
- **Macintosh OSX**
Only "Read" is possible (when the supplied driver or a commercially available writing software is not used).
- **Macintosh OS9.2.1, OS9.2.2**
Both "Read" and "Write" are possible (when the supplied driver or a commercially available writing software is not used).

* All company names and model names mentioned in this manual are trademarks or registered trademarks of their respective holders.

<Note>: By installing the optional IEEE1394/USB card, the "IEEE1394" menu item is added to the "SYS SETUP" menu of the MENU mode.

```

MENU▶SYS▶
Keyboard:US
Startup disk:DVD
CD stop mode:CD end
Adjust RTC▶
IEEE1394:DISCONNECT
▶Version▶
        
```

Added →

Connecting PC to the unit

After connecting the cable between the unit and a PC, make the setting below while the PC is on.

<Note>: In the following operation, we assume that a recorded DVD-RAM disk is set to the unit and an audio file is loaded.
If no disk is set, you cannot make the "IEEE1394" menu setting in the "SYS SETUP" menu.

- 1) Set the "IEEE1394" menu item in the "SYS SETUP" menu of the MENU mode to "CONNECT".

How to unmount the DV824 from the PC

To unmount the DV824 from the PC, make the PC side ready for unmounting the DV824, disconnect the IEEE1394 cable, and set the "IEEE1394" menu item to "DISCONNECT".

Depending on the PC, the method for making the PC ready for unmounting the DV824 differs. Please refer to the instructions of the PC.

<Note>: Depending on the OS, the unmounted device may be immediately mounted again. Therefore, to stop using IEEE1394, disconnect the cable immediately after unmounting the unit.

<Note>: You can mount only the DVD-RAM drive. The optional Model 9057 cannot be mounted to your PC. To transfer files between the Model 9057 and the PC, use the Ethernet function (**see page 73**).

Example of copying data to a computer hard disk

In the following procedure, we assume that the cable between the DV824 and the PC is connected and the "IEEE1394" menu item in the "SYS SETUP" menu of the MENU mode is set to "CONNECT".

<Note>: When the "IEEE1394" menu item is set to "CONNECT", the keys and dial on the DV824 panel are disabled.

- 1) Make sure that the DV824 icon appears on the desktop of your computer (note that the icon looks differently depending on the personal computer).
- 2) Start up an appropriate application such as Explorer on the computer, and copy an audio data file in the DV824 drive to the computer hard disk.

Example of exporting data to a computer application

The procedure example below shows how to export DV824 data to Digidesign Pro Tools for Macintosh. For details about operations of Pro Tools, see the instructions supplied with Pro Tools. Note that the screen examples below may look different from the screen you actually see. Also note that the procedure below is assumed that the DV824 is connected to the PC and the "IEEE1394" menu in the Utility mode is set to "CONNECT".

- 1) Start up the application software (Pro Tools, in this example).
- 2) Click on "Audio" on the Pro Tools screen to pop up the audio region list menu (indicated by an arrow 1).
- 3) Select and click on the "Import Audio" menu from the popup menu (indicated by an arrow 2).

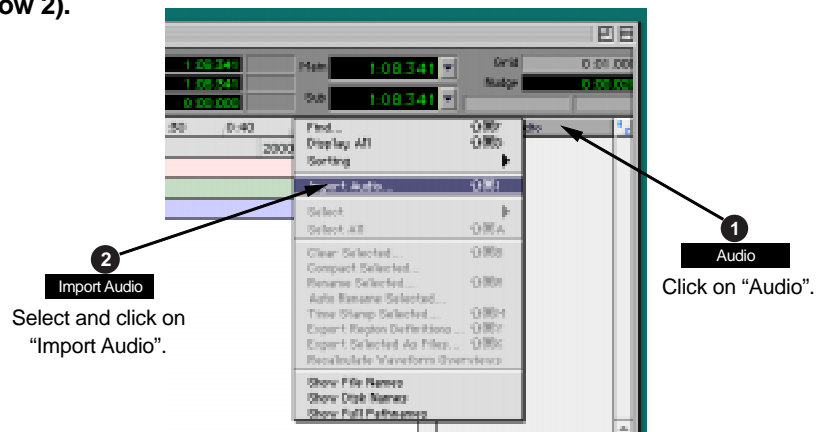

- 4) Select and click on "DV824-DVD" (or "S001") on the desktop (indicated by an arrow 3).

The disk volume label example shown below is a default tentative name. If you have edited the volume name (Reel No.) in the disk formatting process, the edited name is shown.



- 5) Select and click on an audio file in the "bwff" directory on the disk (indicated by an arrow 4).
The selected audio file is shown in "Region in current file".
- 6) Click on "Convert ->", followed by "Done" (indicated by an arrow 5).
The display shows the window for saving a file.

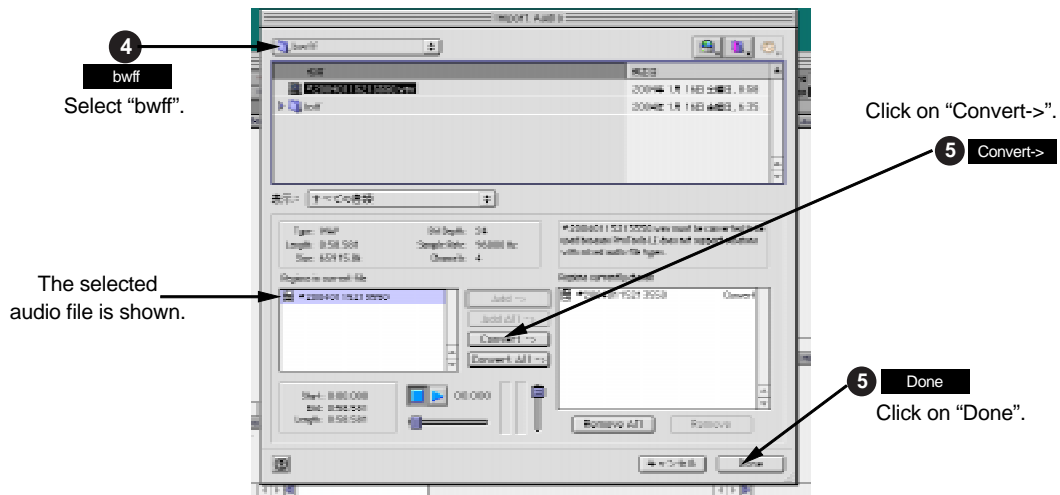

- 7) Select a saving file and click on "Select" (indicated by an arrow 6). The computer starts saving the file to the selected file.

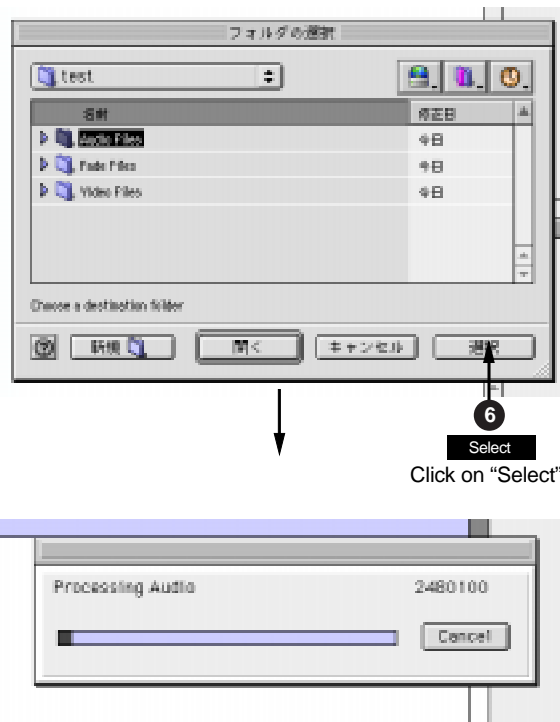

The saved file is added to the audio region list (indicated by an arrow 7).

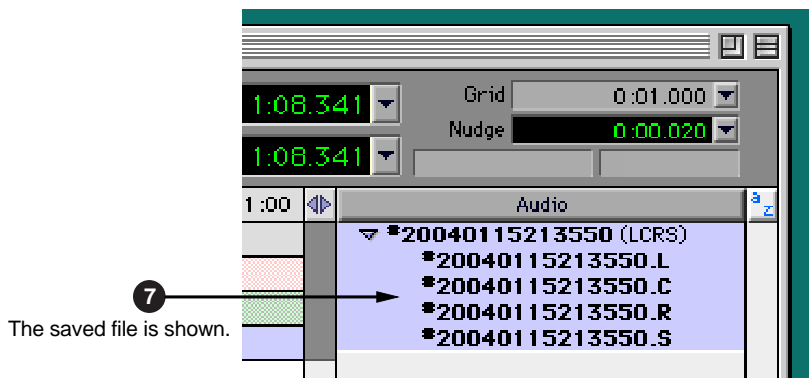

- 8) After making "Spot" active, drag and drop the audio region list to the track area (indicated by an arrow 8).
The "Spot Dialog" setting window appears.

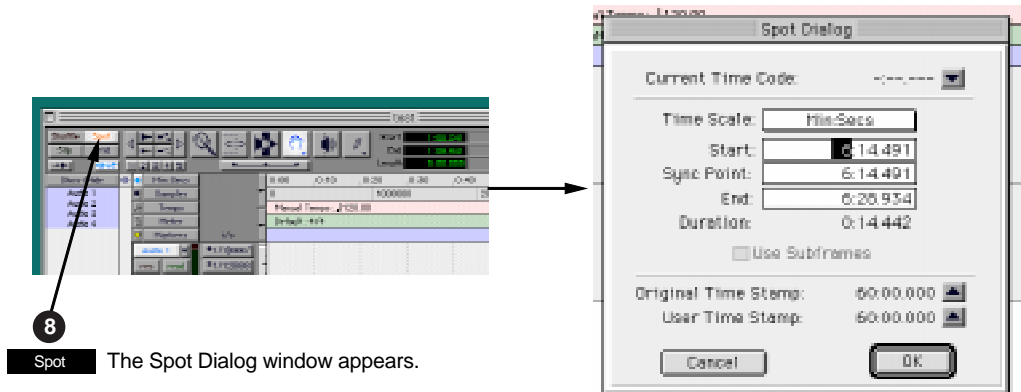

- 9) Click on "▲" in the "Spot Dialog" setting window, followed by "OK" (indicated by an arrow 9).
By clicking on "▲", the "original time stamp" time currently shown is set to the "Start" time. Then clicking on "OK" starts importing audio data from the specified position.

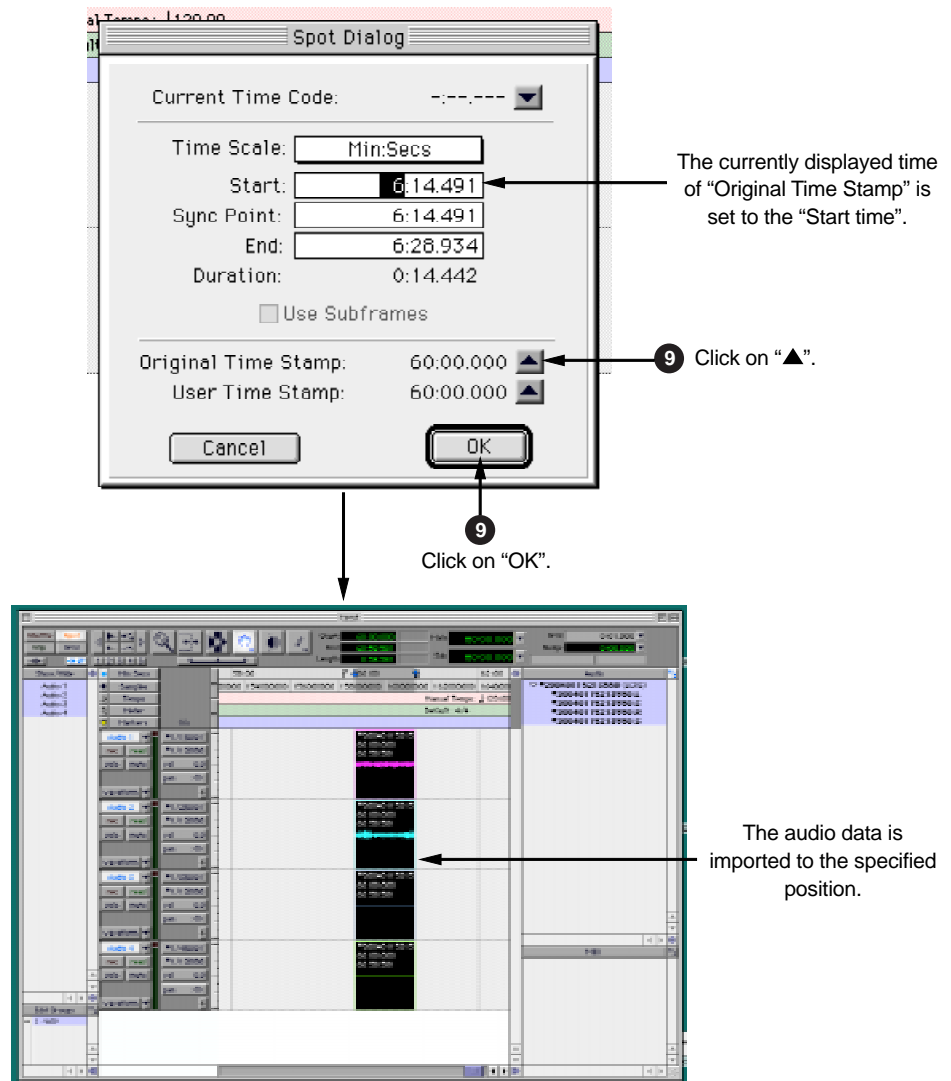

Chapter-7: Creating and editing ALE files (EDIT EDL FILE menu)

This chapter describes details about how to create an ALE (Avid Log Exchange) file for exporting audio data of the DV824 to an AVID system, as well as how to edit an existing ALE file.

Table of contents

Creating a new ALE file	100
Adding audio file entries to an ALE file	103
Viewing and editing audio file entries	105
Viewing audio file entries	105
Adding an audio file entry to an existing ALE file	106
Deleting an audio file entry	106
Editing an ALE file	107
Editing an ALE file name	107
Remaking an ALE file	108
Deleting an ALE file	109

On a DVD-RAM disk, the DV824 creates the "info" folder under the "bwff" folder. The "Info" folder stores ALE (Avid Log Exchange) files and various information files such as a diagnoses file.

About an ALE file

An ALE file is an EDL (Edit Decision List) file for exporting audio data created by the DV824 to an AVID system. Because it is a text file, a personal computer easily reads it. Note that the start and end time values of the file are referenced to the BWF time reference and data length. The ALE file is also used for the DV824 list play function.

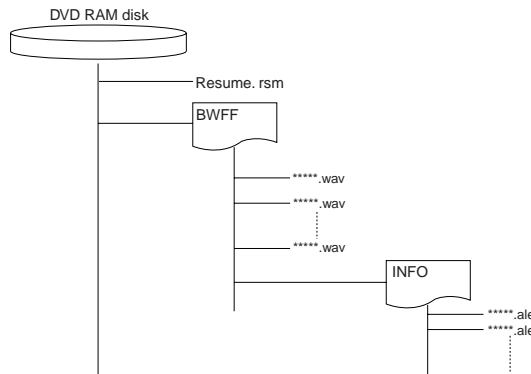

Creating a new ALE file

You can create a new ALE file on a recorded DVD-RAM disk. In the procedure described below, we assume that more than one audio file (BWF) is created on the DVD-RAM disk set to the DV824.

- 1) While the unit is stopped, press the [SHIFT] key to light the [SHIFT] indicator, followed by the [LIST PLAY/[EDIT EDL]] key.

The unit enters the "EDIT EDL FILE" menu and the display now shows the ALE screen for selecting an ALE file.



<Note>: If no ALE file exists on the disk, only "<New file>" is shown as the screen example above. If any ALE file exists on a disk, its current file name is shown.

<Note>: You can also enter the "EDIT EDL FILE" menu by following the procedure below.

- Press the [ENTER/YES] key to enter the MENU mode.
- Use the [MENU] dial to highlight "EDIT EDL FILE" and press the [ENTER/YES] key.



- 2) While "<New file>" is highlighted, press the [ENTER/YES] key.
 The display now shows the screen for entering a name of a newly created ALE file.

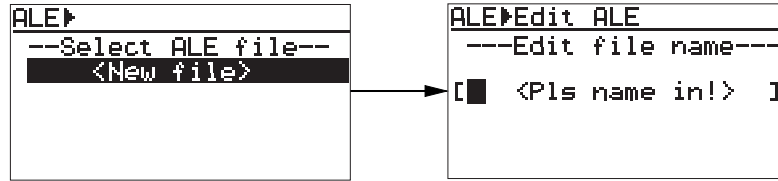

<Note>: The display shows the screen for entering a file name when creating a new ALE file, however, it shows the screen on which "Remake ALE" is highlighted if you select an existing ALE file for editing.

- 3) Use the [MENU] dial (or the alphanumeric keys) to enter the desired name.
 In the screen example below, "ALL-TAKE" is entered as an ALE file name.

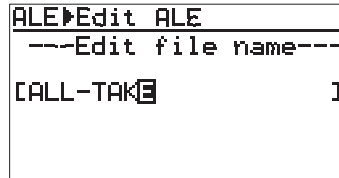

- 4) After entering the desired name, press the [ENTER/YES] key to confirm your setting.
 The entered name is stored, while the display changes to show the screen for editing the ALE file, on which the "Video format" menu item is highlighted.

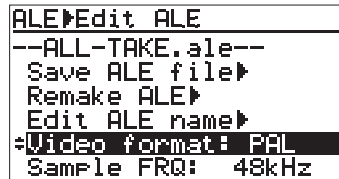

You can select a desired menu item by rotating the [MENU] dial. Typically, when you create a new ALE file, you make settings of menu items in the following order.

"Video format" -> "Sample FREQ" -> "TAPE" -> "TC frame" -> "Drop frame"

With each menu item, you can make editing/setting as below.

Menu	Function
Delete ALE file	Deletes an ALE file.
Save ALE file	Saves an ALE file.
Remake ALE	Remakes an ALE file.
Edit ALE name	Edits the name of an ALE file.
Video format	Sets the video format of an ALE file.
Sample FRQ	Sets the sampling frequency of an ALE file.
TAPE	Sets the reel number (TAPE) of an ALE file.
TC frame	Sets the TC Frame Rate of an ALE file.
Drop frame	Selects "On" or "Off" of the TC drop frame. You need to set it to "On" when you select "29.97" for the TC frame.
Entry files	Adds/deletes an audio file to/from the ALE file.

5) While "Video format" is highlighted, press the [ENTER/YES] key.

The display changes to show the screen on which you can select the video format. The current option flashes (the default is "PAL").

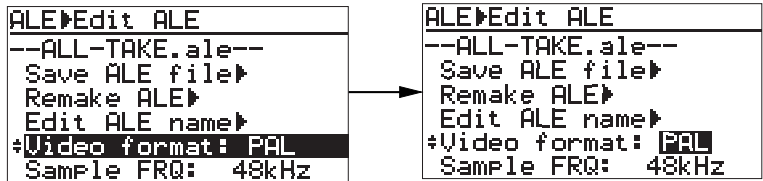

6) Use the [MENU] dial to select the video format, and press the [ENTER/YES] key to confirm your setting.

You can select the video format from among "PAL", "NTSC" and "SECAM".

In the same manner as above, set the other menu items in the following order.

"Sample FREQ" -> "TAPE" -> "TC frame" -> "Drop frame"

The following table shows the options for each menu item setting.

Menu item	Options
Sample FRQ	You can select from among 22kHz, 32kHz, 44kHz, 48kHz, 88kHz and 96kHz.
TAPE	You can enter up to eight desired characters for a reel number (TAPE).
TC frame	You can select from among 23.97, 30, 24, 29.97 and 25.
Drop frame	You can select between On and Off (the default is "Off").

The initial setting for each menu item except the "Drop frame" menu item reflects the setting of the audio file loaded before the unit enters the EDIT EDL FILE menu.

<Notes>

- If you set the "TC frame" menu to "29.97", set the "Drop frame" menu to "On".
- You can use the [MENU] dial (or the alphanumeric keys) to enter "TAPE" (reel number).
Use the [SKIP/CURSOR] key to move the cursor.
When using the alphanumeric keys for entering characters, pressing any other numeric key moves the cursor to the right automatically.

7) After making necessary settings, press the [EXIT/NO] key.

The display now shows the confirmation screen for making a new ALE file, on which "Are you sure?" flashes.



<Note>: To cancel creating a file list, press the [EXIT/NO] key now.

8) Press the [ENTER/YES] key.

A new ALE file is created and added to the ALE file list.

".ale", the file extension, is automatically added to the file name when an ALE file is created.

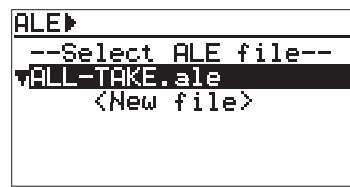

To create another new ALE file, select "<New file>" and follow the same procedure as above.

If you want to exit the EDIT EDL FILE menu, press the [EXIT/NO] key to dismiss the "Edit ALE" screen. In the following description, we continue editing operation and add audio file entries.

Adding audio file entries to an ALE file

You can add audio file entries to an ALE file.

The following shows how to add desired audio file entries to the ALE file named "ALL-TAKE.ale", created by the procedure described above.

<Notes>

- If more than one audio file entry in the ALE file overlaps the playback range, the audio file entry you added earlier takes priority. The audio file entry you added later cannot be played back in the list play mode.
- Only audio file entries whose FS match the FS set for the ALE file can be added.
- When playing back audio file entries in the DV824 list play mode, the condition follows the DV824 settings for the list play function, regardless of the ALE file settings.

- 1) While "ALL-TAKE.ale" is highlighted, press the [ENTER/YES] key.

The display now shows the screen for editing the ALE file, on which "Remake ALE" is highlighted.

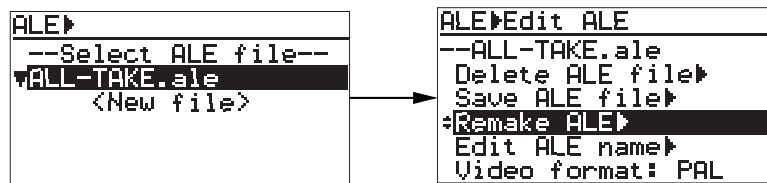

- 2) Use the [MENU] dial to select the "Entry files" menu item at bottom of the menu, and press the [ENTER/YES] key.

The display now shows the screen for audio file entry, on which "<New entry>" is highlighted.

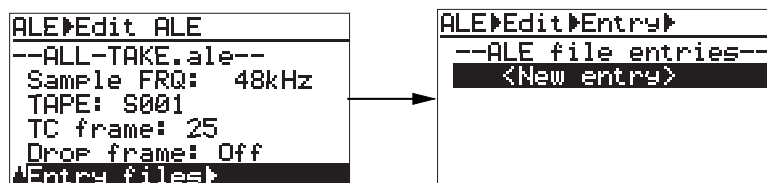

- 3) While "<New entry>" is highlighted, press the [ENTER/YES] key.

After showing "Please wait!", the display changes to shows the screen for selecting audio files.

If you select "<Entry all>", all audio files on the current disk which can be added to the ALE file are added.

You can also select from individual files shown below "<Entry all>".



<Note>

We recommend setting "Circle Take" to each audio file you want to add to an ALE file later. When "Circle Take" is set to the file, "@" is added to the beginning of the file name , so it is easy to select the file (see below for details).

<How to set "Circle Take" to a file>

You can set "Circle Take" only when a USB keyboard is connected to the unit. While the desired audio file is loaded and the display shows the Home screen, press [F2] on the USB keyboard.

"@" is added to the beginning of the file name on the Home screen (pressing [F2] again cancels "Circle Take") .

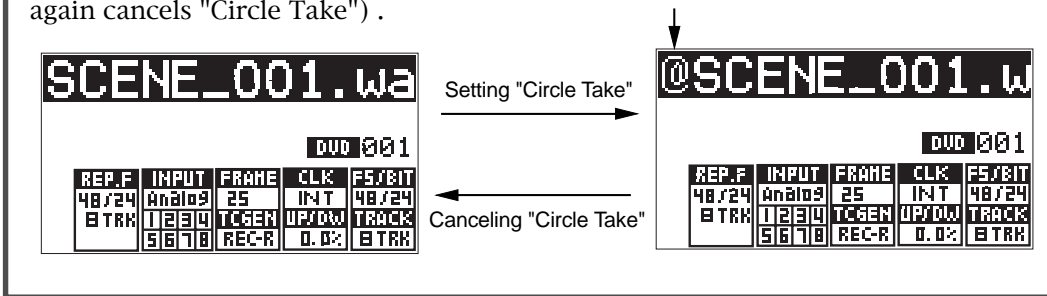

4) Select "<Entry all>" or any desired audio file, and press the [ENTER/YES] key.

If you select "<Entry all>" and press the [ENTER/YES] key, all audio file entries are shown on the screen (you can scroll through the list by rotating the [MENU] dial) .



If you select an individual audio file and press the [ENTER/YES] key, "Sel. next entry!" is shown and you can make another selection successively.

Note that the audio file entries added to the ALE file are omitted from the list.

After adding all desired files to the ALE file, press the [EXIT/NO] key.

The display now shows the screen as below, on which you can check the entries. In the screen example below, audio file "001" is added.



5) After adding audio file entries, press the [EXIT/NO] key.

The display returns to the screen for selecting an item for editing the ALE file.

6) Press the [EXIT/NO] key again (or use the [MENU] dial to select "Save ALE file" and press the [ENTER/YES] key).

The display shows the screen for saving the ALE file, on which "Are you sure?" flashes.

7) Press the [ENTER/YES] key to save the ALE file.

8) Press the [EXIT/NO] key to exit the EDIT EDL FILE menu.

Viewing and editing audio file entries

You can view audio file entries in an ALE file, as well as add (or delete) an audio file entry to (or from) the ALE file.

Viewing audio file entries

We assume that you have created an ALE file named "ALL-TAKE.ale", as described in the previous procedure.

- 1) **While the unit is stopped, press the [SHIFT] key to light the [SHIFT] indicator, followed by the [LIST PLAY/[EDIT EDL]] key.**

The unit enters the "EDIT EDL FILE" menu and the display now shows the ALE screen for selecting an ALE file. You can see "ALL-TAKE.ale" and "<New file>" in the "Select ALE file" list.

```
ALE▶
--Select ALE file--
▼ALL-TAKE.ale
  <New file>
```

- 2) **While "ALL-TAKE.ale" is highlighted, press the [ENTER/YES] key.**

After showing "Please wait!", the display shows the screen for editing an ALE file (on which "Remake ALE" is highlighted).

```
ALE▶
--Select ALE file--
▼ALL-TAKE.ale
  <New file>
```

```
ALE▶Edit ALE
--ALL-TAKE.ale
Delete ALE file▶
Save ALE file▶
▲Remake ALE▶
Edit ALE name▶
Video format: PAL
```

- 3) **Use the [MENU] dial to select "Entry files", and press the [ENTER/YES] key.**

The screen now shows the entry list in which you can scroll through audio file entries by rotating the [MENU] dial.

```
ALE▶Edit ALE
--ALL-TAKE.ale--
Sample FRQ: 48kHz
TAPE: S001
TC frame: 25
Drop frame: Off
▲Entry files▶
```

```
ALE▶Edit▶Entry▶
--ALE file entries--
▼001 ***** .wav
  002 ***** .wav
  003 ***** .wav
  004 ***** .wav
  005 ***** .wav
```

While the file entry list above is shown, you can add a new audio file to the list or delete an unnecessary audio file from the list. See the next page for details.

If you want to exit the EDIT EDL FILE menu after viewing the list, press the [EXIT/NO] key repeatedly until exiting the EDIT EDL FILE menu.

Adding an audio file entry to an existing ALE file

- 1) **On the entry list screen shown in step 3 of "Viewing audio file entries" in the previous page, use the [MENU] key to select "<New entry>" and press the [ENTER/YES] key.**
The display now shows the list, in which available audio files except those already added to the ALE file, as well as "<Entry all>", are listed.
- 2) **Select "<Entry all>" or any desired audio file, and press the [ENTER/YES] key.**
The selected audio file is added to the ALE file (if you select "<Entry all>", all available files are added).
- 3) **After adding all desired audio file to the ALE file, press the [EXIT/NO] key.**
The display returns to show the entry list screen.
- 4) **Press the [EXIT/NO] key twice.**
The display shows the screen for resaving the edited ALE file, on which "Are you sure?" flashes.
- 5) **Press the [ENTER/YES] key to resave the ALE file.**

To exit the EDIT EDL FILE menu, press the [EXIT/NO] key repeatedly.

Deleting an audio file entry

- 1) **On the entry list screen, use the [MENU] dial to select the file entry you want to delete and press the [CLEAR] key.**
After showing "Deleted!", the selected file entry is deleted immediately.

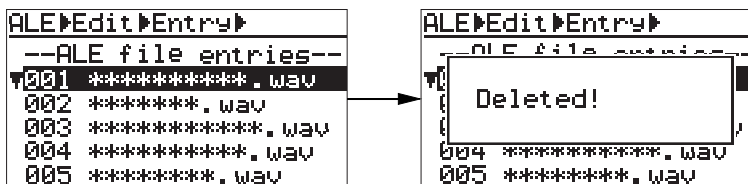

- 2) **Press the [EXIT/NO] key twice.**
The display shows the screen for resaving the edited ALE file, on which "Are you sure?" flashes.
- 3) **Press the [ENTER/YES] key to resave the ALE file.**

To exit the EDIT EDL FILE menu, press the [EXIT/NO] key repeatedly.

Editing an ALE file

You can edit an existing ALE file.

The editing functions include:

- Editing an ALE file name and resave it.
- Remaking an ALE file after its audio file entry is edited.
- Deleting an unnecessary ALE file.

Editing an ALE file name

You can edit an existing ALE file name and resave the edited name.

The following example shows how to edit the "ALL-TAKE.ale" ALE file created in the operation example described earlier.

- 1) **While the unit is stopped, press the [SHIFT] key to light the [SHIFT] indicator, followed by the [LIST PLAY/[EDIT EDL]] key.**

The display now shows the ALE list for selecting a desired ALE file from among the existing ALE files (in the ALE list example below, "ALL-TAKE.ale" is shown).

```
ALE▶
--Select ALE file--
ALL-TAKE.ale
<New file>
```

- 2) **While "ALL-TAKE.ale" is highlighted, press the [ENTER/YES] key.**

After showing "Please wait!", the display changes to show the screen for ALE file editing.

- 3) **Use the [MENU] dial to select "Edit ALE name" and press the [ENTER/YES] key.**

The display now shows the screen for file name editing, on which the leftmost character of the current name flashes.

```
ALE▶Edit ALE
--ALL-TAKE.ale
Delete ALE file▶
Save ALE file▶
Remake ALE▶
*Edit ALE name▶
Video format: PAL
```

→

```
ALE▶Edit ALE
--Edit file name--
[ALL-TAKE.ale ]
```

Use the [SKIP/CURSOR] keys to move the cursor position and use the [MENU] dial (or the alphanumeric keys) to enter a desired character.

By pressing the [CLEAR] key repeatedly when the cursor is pointing the leftmost character, you can clear the whole name.

The file extension (".ale") is automatically added to the name so you do not need to enter it.

- 4) **After completing editing the name, press the [ENTER/YES] key.**

The new name is confirmed and the display returns to the screen on which you can select an editing item.

- 5) **Press the [EXIT/NO] key repeatedly until you exit the EDIT EDL FILE menu.**

Remaking an ALE file

If you edit the start time, end time, or the description information of an audio file which is listed in the ALE file, the ALE file must be remade. You can also remake the ALE file which contains only audio files whose "Circle take" is set to "On".

The following procedure describes how to remake the ALE file named "ALL-TAKE.ale", assuming that any of audio files listed in the ALE file has been edited after it was added to the ALE file.

- 1) **While the unit is stopped, press the [SHIFT] key to light the [SHIFT] indicator, followed by the [LIST PLAY/EDIT EDL] key.**

The unit enters the "EDIT EDL FILE" menu and the display now shows the ALE screen for selecting an ALE file.

On the example screen below, "ALL-TAKE.ale" is shown.

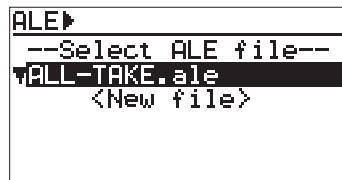

- 2) **While "ALL-TAKE.ale" is highlighted, press the [ENTER/YES] key.**

After showing "Please wait!", the display shows the screen for editing an ALE file (on which "Remake ALE" is highlighted).

- 3) **While "Remake ALE" is highlighted, press the [ENTER/YES] key.**

The display now shows the screen for selecting the remaking "Type" (by default, "Renewal" flashes).

You can select the "Type" option between "Renewal" and "Circle Take".

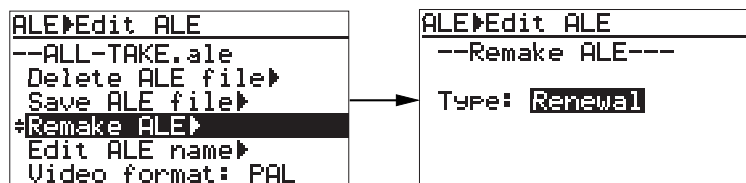

Renewal	Circle Take
The audio file entry list in the ALE file is not changed. The ALE file is updated by re-making only the edited items (such as the start time, end time, etc.) in audio files.	A new ALE file, containing only audio file entries whose "Circle take" is set to "On", is created. The old (previous) ALE file is deleted.

- 4) **Select the desired type and press the [ENTER/YES] key.**

If you select "Renewal", the DV824 immediately remakes the ALE file, and the display returns to show the screen on which you can select an editing item.

If you select "Circle Take", "Sure?" flashes on the screen. Press the [ENTER/YES] key again.

The DV824 remakes the ALE file, and the display returns to show the screen on which you can select an editing item.

<Note>: As described above, executing "Circle Take" erases the old list. If you cancel executing "Circle Take" in step 4) above, press the [EXIT/NO] key.

- 5) **After "Remake ALE" completes, press the [EXIT/NO] key.**
The display shows the screen for updating the remade ALE file, on which "Are you sure?" flashes.
- 6) **Press the [ENTER/YES] key.**
The remade ALE file is updated and the display returns to show the screen on which you can select an editing item.
- 7) **Press the [EXIT/NO] key repeatedly until you exit the EDIT EDL FILE menu.**

Deleting an ALE file

You can delete an ALE file.

The following procedure example describes how to delete the "ALL-TAKE.ale" file.

- 1) **While the unit is stopped, press the [SHIFT] key to light the [SHIFT] indicator, followed by the [LIST PLAY/[EDIT EDL]] key.**
The unit enters the "EDIT EDL FILE" menu and the display now shows the ALE screen for selecting an ALE file.
On the example screen below, "ALL-TAKE.ale" is shown.

```

ALE▶
--Select ALE file--
▼ALL-TAKE.ale
  <New file>

```

- 2) **While "ALL-TAKE.ale" is highlighted, and press the [ENTER/YES] key.**
After showing "Please wait!", the display shows the screen for editing an ALE file (on which "Remake ALE" is highlighted).
- 3) **Use the [MENU] key to select (highlight) "Delete file ALE", and press the [ENTER/YES] key.**
The display now shows the screen for deleting the selected ALE file, on which "Are you sure?" flashes.

```

ALE▶Edit ALE
--ALL-TAKE.ale--
▼Delete ALE file▶
Save ALE file▶
Remake ALE▶
Edit ALE name▶
Video Format:NTSC

```

→

```

ALE▶Edit ALE
---Delete file---
ALL-TAKE.ale
Are you sure?
Yes:ENTER key
No :Exit key

```

- 4) **Press the [ENTER/YES] key to delete the file.**
The ALE file is deleted and the display returns to show the screen for selecting an ALE file.
- 5) **Press the [EXIT/NO] key repeatedly until you exit the EDIT EDL FILE menu.**

Chapter-8: MENU mode

Table of contents

About MENU mode	112
"SYS SETUP" menu	113
Basic procedure for using the "SYS SETUP" menu	114
Default file name setting [Default file name]	115
Default track name setting [Default track name]	116
Next event number setting [Next event No.]	116
Recording track setting [Record tracks]	117
Recording FS/bit length setting [Record FS&Bit]	117
Pull up/down setting [Pull Up/Down]	118
Maximum file length setting [Max file length]	118
Input selection [Select input]	119
Digital input channel setting [Setup digital in]	119
Digital output signal format selection [Digital out]	120
Pre recording time setting [Pre rec time]	120
Auto EE mode selection [Auto EE mode]	121
Slate tone/pop tone recording mode setting [Tone rec mode]	121
Peak hold time setting [Peak hold]	122
Reference level setting [Reference level]	122
Skip mode setting [Skip mode]	123
Diagnoses file setting [diagnoses]	123
USB keyboard type setting [Keyboard]	123
Startup disk selection [Startup disk]	124
ROM version checking [Version]	124
"TC SETUP" menu	125
Basic procedure for using the "DISK UTILITY" menu	126
System clock selection [Sync clock]	127
TC frame rate selection [Frame rate]	127
Generator mode selection [Gen mode]	128
Internal TC generator setting [Set Gen TC]	128
Jam mode setting [JAM mode]	129
User bit setting [Gen Ubit]	129
Time code output source selection [Sel. TC Out]	130
Default LTC start time setting [Default LTC start]	130
LTC start time editing [Edit LTC start]	132
UBIT setting of playback time code [RepTC Ubit]	133
Time code output while paused [Rep pause TC]	134
Reference time code selection [Ref TC sel]	134
Chase mode selection [Chase mode]	135
Chase offset setting [Chase offset]	136
Synchronization to a film machine [Bi-Phase setup]	138
"DISK UTILITY" menu	140
Basic procedure for using the "DISK UTILITY" menu	141
Editing a file name [Edit file name]	142
Viewing a file information and editing descriptor information [File info.]	143
Deleting an unnecessary audio file [Delete file]	146
Restoring a deleted audio file [Restore Del. file]	147
Optimizing a disk [Optimize disk]	148
Formatting a disk [Format]	149
Editing the reel number (Volume label) [Reel No.]	152
Record protection On/Off setting [Rec protect]	153
Resume function On/Off setting [Resume]	154
Partition protection On/Off setting [Part. protect]	154
"LOAD SETUP" menu	155
"SAVE SETUP" menu	156

About MENU mode

In the MENU mode, various essential setting and execution menu items are available. While the unit is stopped, pressing the [ENTER/YES] key enters the MENU mode and the display shows the MENU list screen. There are eleven menus in the MENU list. You can select a desired menu using the [MENU] dial.

This chapter describes four of the eleven menus marked by "*" in the table below. For details of the other menus, see the appropriate sections (pages) indicated below.

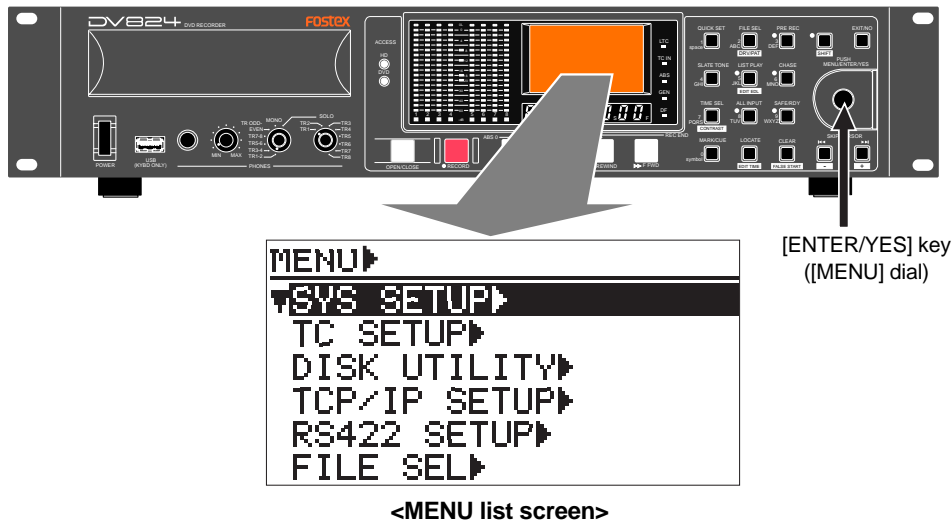

<MENU list screen>

Menu name (in the displayed order)	Contents
* SYS SETUP menu	This menu includes menu items for setting preferences. 23 menu items are available.
* TC SETUP menu	This menu includes menu items regarding time code recording/playback, synchronization to an external device, etc. Fifteen menu items are available.
* DISK UTILITY menu	This menu includes menu items for settings regarding a DVD-RAM disk and the optional hard disk drive, as well as disk formatting. Twelve menu items are available.
TCP/IP SETUP menu	This menu includes menu items regarding TCP/IP settings for using the unit as an FTP server in the Ethernet. Five menu items are available. See page 76 for details.
RS422 SETUP menu	This menu includes menu items regarding settings for controlling the unit via RS422. Four menu items are available. See page 71 for details.
FILE SEL menu	This menu allows you to select an audio file. You can directly enter this menu simply by pressing the [FILE SEL] key. See page 59 for details.
DRV/PAT SEL menu	This menu allows you to select a drive/partition. You can directly enter this menu by pressing the [FILE SEL] key while holding down the [SHIFT] key. See page 83 for details.
CUE LIST menu	This menu allows you to view and edit the cue list. You can directly enter this menu simply by pressing the [MARK/CUE] key. See page 56 for details.
EDIT EDL FILE menu	This menu allows you to create and edit an ALE file. You can directly enter this menu by pressing the [LIST PLAY] key while holding down the [SHIFT] key. See page 99 for details.
* LOAD SETUP menu	This menu allows you to load the settings saved by using the SAVE SETUP menu.
* SAVE SETUP menu	This menu allows you to save the whole settings in the MENU mode.

SYS SETUP menu

In the SYS SETUP menu, 23 menu items for settings regarding recording/playback are available. This section explains the following menu items in the table below. For the "Auto copy", "CD stop mode" and "Adjust RTC" menu items in the SYS SETUP menu, see pages shown below.

Menu item	Details of settings		Default
Default file name	File Name Mode	Date, Take	Take
	Scene Name	Max. 247 characters Note: Up to 55 characters are valid for BWF.	-
	Take Number	001 ~ 999	001
Default track name	TRK1 ~ TRK 8	Up to 16 characters can be entered.	track1~8
Next event No.	00001 ~ 99999		00001
Record tracks	1, 2, 4, 5, 6, 8		8
Record FS & Bit	22k/16, 44k/16, 44k/24, 48k/16, 48k/24, 88k/24, 96k/24		48k/24
Pull Up/Down	-0.1%, 0.0%, +0.1%		0.0%
Max file length	2G, 4G		4G
Select input	Analog, Digital		Analog
Setup digital in	CH1-2	Digital, Analog	Digital
	CH3-4	Digital, Analog	Digital
	CH5-6	Digital, Analog	Digital
	CH7-8	Digital, Analog	Digital
Digital out	AES/EBU, SPDIF		AES/EBU
Auto EE mode	On, Off		Off
Pre rec time	01 ~ 10 seconds		10 sec.
* Auto copy	See page 83 for details.		
Tone rec mode	Tone Rec Time	01 ~ 30 seconds	10 sec.
	Tone Rec On/Off	Off, TONE, 4POP TONE	Off
	End pop tone	On, Off	Off
Peak hold	0 ~ 9 seconds, ∞ (infinity)		3 sec.
Ref. level	-12dB, -18dB, -20dB		-20dB
Skip mode	File, Cue		File
Diagnoses	On, Off		On
Keyboard type	US, JAPAN		US
Startup disk	DVD (AUTO and PT1 through PT8 are also available when the optional hard disk drive is installed.)		DVD
* CD stop mode	See page 65 for details.		CD end
* Adjust RTC	See page 17 for details.		When shipped
Version	-		When shipped

Basic procedure for using the "SYS SETUP" menu

The basic procedure for using the "SYS SETUP" menu is as described below.

1) While the unit is stopped, press the [ENTER/YES] key.

The unit enters the MENU mode and the MENU list screen as below is shown.
When "▼" is shown, you can scroll the screen downward.
The item with "▶" on the right has the next level screen.

```

MENU▶
▼SYS SETUP▶
TC SETUP▶
DISK UTILITY▶
TCP/IP SETUP▶
RS422 SETUP▶
FILE SEL▶
  
```

2) While "SYS SETUP" is highlighted, press the [ENTER/YES] key.

The display now shows the SYS SETUP menu screen.

```

MENU▶SYS▶
▼Default file name▶
Default track name▶
Next event No:00001
Record tracks: 8
Record FS&Bit:48k/24
Pull Up/Down: 0.0%
  
```

3) Use the [MENU] dial to select the desired menu item and press the [ENTER/YES] key.

The display now shows the first level screen of the selected menu item.

Selecting a menu item with "▶" on the right brings up the second level screen.
If you select a menu item without "▶", the current setting flashes and you can now make selection on the first level screen.

For details of setting for each item, see the following pages.

Example of a menu item which has the second level screen

(Selecting the item brings up the second level screen.)

<pre> MENU▶SYS▶ ▼Default file name▶ Default track name▶ Next event No:00001 Record tracks: 8 Record FS&Bit:48k/24 Pull Up/Down: 0.0% </pre>	→	<pre> SYS▶Def.file name ---File name mode--- File name mode:Take ---Default file name--- SCENE NAME: [SCENE] TAKE NUMBER:[001] </pre>
---	---	---

Example of a menu item of which you can make setting on the first level screen

(The current setting flashes.)

<pre> MENU▶SYS▶ Default file name▶ Default track name▶ Next event No:00001 Record tracks:8 Record FS&Bit:48k/24 Pull Up/Down: 0.0% </pre>	→	<pre> MENU▶SYS▶ Default file name▶ Default track name▶ Next event No:00001 Record tracks:8 Record FS&Bit:48k/24 Pull Up/Down: 0.0% </pre>
---	---	---

Pressing the [EXIT/NO] key goes up the level one by one. Therefore, you can exit the MENU mode by pressing the [EXIT/NO] key repeatedly. You can, however, exit the MENU mode directly by pressing the [STOP/HOME] key.

Default file name setting [Default file name]

The "Default file name" menu item selects the default name format of an audio file which is created automatically when recording starts.

You can give a file name of date information (according to the internal realtime clock) or a scene name with a take number.

• Selecting the "File name mode"

When you highlight "Default File Name" and press the [ENTER/YES] key on the SYS SETUP menu screen, the second level screen appears. On this screen, "File name mode: ***" is highlighted. By pressing the [ENTER/YES] key again, the current setting starts flashing and you can now make selection using the [MENU] dial. By default, "Take" flashes.

If you select "Take" and press the [ENTER/YES] key, the screen prompts you to set "Default file name".

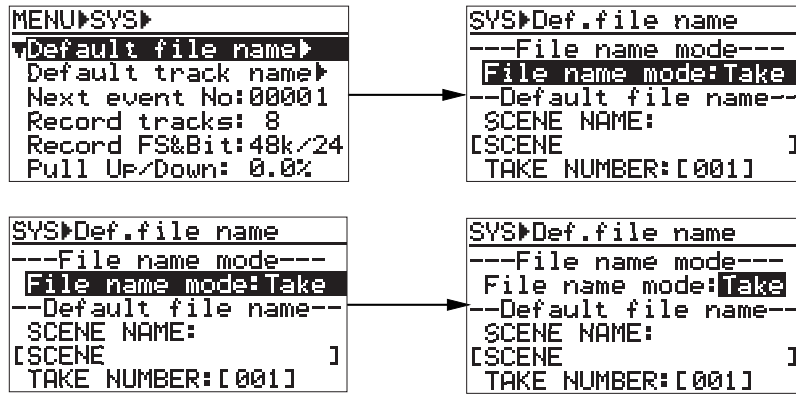

You can select from among "Date" and "Take" (the default is "Take".)	
Date	The internal realtime clock data (with ".wav", the file extension) is the file name. Example: B05h 05m 06s 10may 2004.wav ("<DATE>" is shown in the "Next file name" field on the Home screen.)
Take	"<SCENE NAME> + <TAKE NUMBER>" (with ".wav", the file extension) is the file name. The TAKE NUMBER is incremented automatically each time recording is made. Example: Last_Scene -001.wav, Last_Scene -002.wav, ...

• Default file name (SCENE NAME/TAKE NUMBER) setting

If you set the "File name mode" to "Take" and press the [ENTER/YES] key, the screen prompts you to enter the SCENE NAME. (You can enter a desired scene name using the [MENU] dial or alphanumeric keys, and move the cursor position using [SKIP/CURSOR] keys.)

After entering the desired scene name, pressing the [ENTER/YES] key confirms the scene name, while the screen prompts you to enter the TAKE NUMBER.

Enter the desired take number with the similar manner, and press the [ENTER/YES] key to confirm your setting.

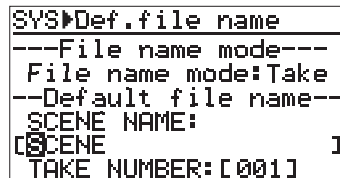

SCENE NAME	Up to 247 ASCII characters can be entered (note that only 55 characters are valid for BWF). The first character must be alphabetical. ".wav", the file extension, is automatically added, therefore, you do not need to enter it.
TAKE NUMBER	Any number between 001 and 999 can be entered. (Note: If you enter "000" to the TAKE NUMBER field, it is automatically set as "001".)

After making "Default file name" setting, press the [STOP/HOME] key to exit the MENU mode.

Default track name setting [Default track name]

The "Default track name" menu item specifies the default track name for each track of a BWF file created when recording is made.

The track name specified is automatically added to the track number whenever an audio file is created. The data is recorded to each file as the "fTRKn" information of the BWF BEXT Chunk Description. The default track name is stored in the System ROM of the unit.

When you highlight "Default Track Name" and press the [ENTER/YES] key on the SYS SETUP menu screen, the current track name of each track is shown. By using the [MENU] dial to select a track and pressing the [ENTER/YES] key, you are ready for entering the track name.

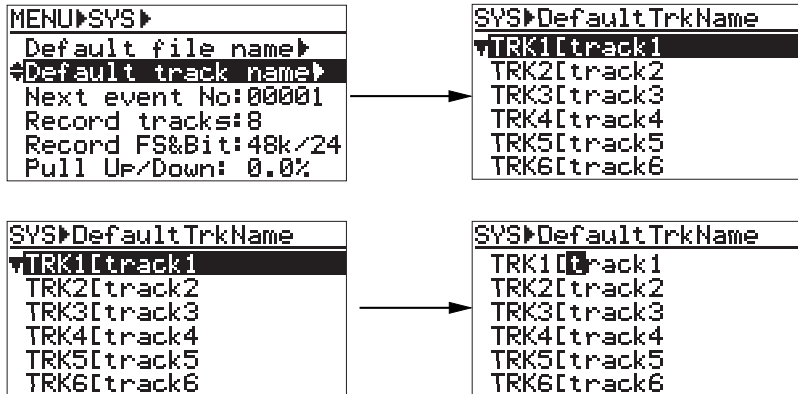

You can enter a desired scene name using the [MENU] dial or alphanumeric keys. After entering the desired track name, press the [ENTER/YES] key to confirm your setting. To exit the MENU mode, press the [STOP/HOME] key.

<Note>: You can change track names of a file later by using the "Edit descriptor" function of the "File Info." menu item in the "DISK UTILITY" menu (see page 143).

Next event number setting [Next event No.]

The "Next event No." menu item sets the event number in the description information of an audio file.

The event number is recorded to each file as "fEVENT" information in the BWF BEXT Chunk Description. The setting is stored in the System ROM of the unit.

Select the "Next event No" menu item and press the [ENTER/YES] key.

The next event number setting starts flashing and you can now edit the number.

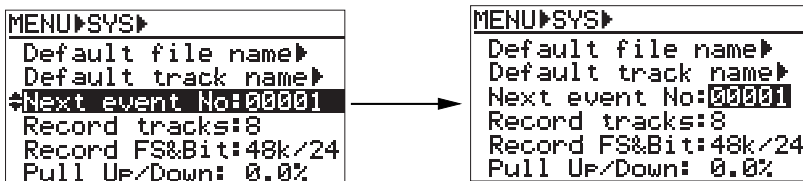

You can set the "Next event No." to a desired number between 00001 and 99999. Use the [MENU] dial to enter the desired number and press the [ENTER/YES] key to confirm your setting. Press the [STOP/HOME] key to exit the MENU mode.

<Notes>

- The edited value is reflected to newly recorded audio files. It does not affect the current audio file.
- If the event number exceeds 99999, the number returns to 00000.

Recording track setting [Record tracks]

The "Record tracks" menu item sets the number of recording tracks. You can also set the number of recording tracks via the quick setup mode on the Home screen. The setting is stored to the Flash ROM of the unit.

Select the "Record tracks" menu item and press the [ENTER/YES] key.

The current track setting starts flashing and you can now select a desired option.

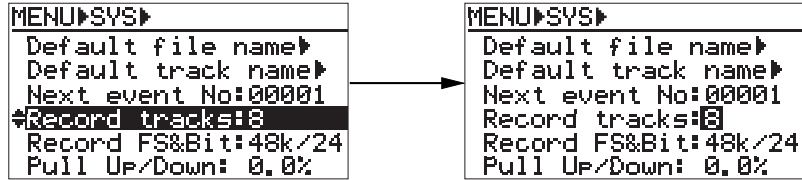

You can select from among "1", "2", "4", "6" and "8" (the default is "8".)

Use the [MENU] dial to select the desired option and press the [ENTER/YES] key to confirm your setting. Press the [STOP/HOME] key to exit the MENU mode.

<Notes>: The current recording track setting is shown in the status area on the Home screen.

While the unit is in the record ready mode, the indicator below the level meter of each recording track flashes in red. It lights steadily during recording.

Recording FS/bit length setting [Record FS&Bit]

The "Record FS&Bit" menu item sets the recording sampling frequency and bit length. You can also make the setting via the quick setup mode on the Home screen. The setting is stored to the Flash ROM of the unit.

<Notes>: If you use a 2x (or less) 4.7GB disk, we do not recommend "44.1k/48k, 24-bit 8-track" and "88.2k/96k, 24bit 4-track" recording.

Select the "Record FS&Bit" menu item and press the [ENTER/YES] key.

The current setting starts flashing and you can now select the desired option.

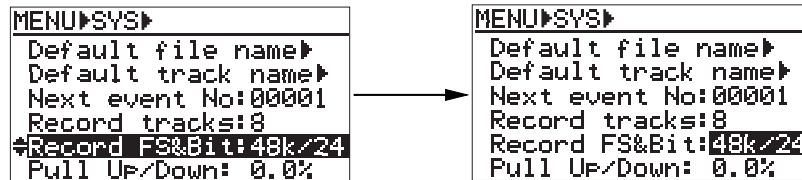

You can select from among the following:
22k/16, 44k/16, 48k/16, 44k/24, 48k/24, 88k/24 and 96k/24 (the default is "48k/24")

Use the [MENU] dial to select the desired option and press the [ENTER/YES] key to confirm your setting. The current setting is shown in the status area on the Home screen.

Press the [STOP/HOME] key to exit the MENU mode.

Pull up/down setting [Pull Up/Down]

The "Pull Up/Down" menu item makes clock pull up/down setting when the unit is referenced to the internal clock. You can also make the setting via the quick setup mode on the Home screen. The setting is stored to the Flash ROM of the unit.

<Note>: The "Pull Up/Down" menu item is valid only when the optional TC/SYNC card is installed. If you are going to make setting when no TC/SYNC card is installed, the display shows "Void! No TC Card" and you cannot make setting.

Select the "Pull Up/Down" menu item and press the [ENTER/YES] key. The current setting starts flashing and you can now select the desired option.

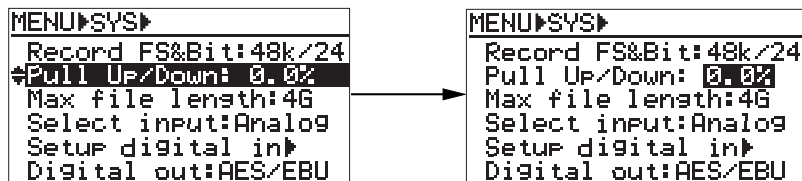

You can select from among "-0.1%", "0.0%" and "+0.1%" (the default is "0.0%.")

Use the [MENU] dial to select the desired option and press the [ENTER/YES] key to confirm your setting. The current setting is shown in the status information area on the Home screen. Press the [STOP/HOME] key to exit the MENU mode.

Maximum file length setting [Max file length]

The "Max file length" menu item sets the maximum recording volume of a file. This setting is important especially for exporting audio file data of the unit to your PC, because each PC has the limitation of the volume of a file to be imported. The setting is stored to the Flash ROM of the unit.

Select the "Max file length" menu item and press the [ENTER/YES] key. The current setting starts flashing and you can now select the desired option.

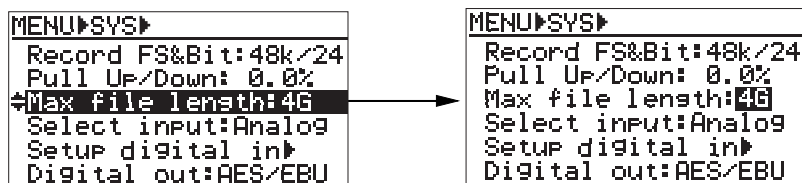

You can select from among "2GB" and "4GB" (the default is "4GB".)

Use the [MENU] dial to select the desired option and press the [ENTER/YES] key to confirm your setting. Press the [STOP/HOME] key to exit the MENU mode.

<Note>: The remaining recordable time of the file which is shown during recording is calculated based on the "Max file length" setting. For example, if the remaining space of the disk is 4 GB or more while "Max file length" is set to 4 GB, the remaining recordable time of the file is calculated based on 4 GB. If the remaining space of the disk is smaller than the "Max file length" setting, the remaining recordable time of the file is calculated based on disk remaining space. For example, if "Max file length" is set to 4 GB while the remaining space of the disk is 2 GB, the display shows the remaining time which is calculated based on 2 GB.

Input selection [Select input]

The "Select input" menu item selects the recording source between analog and digital. You can also make this selection via the quick setup mode on the Home screen. The setting is stored to the Flash ROM of the unit.

Select the "Select input" menu item and press the [ENTER/YES] key.

The current setting starts flashing and you can now select the desired option.

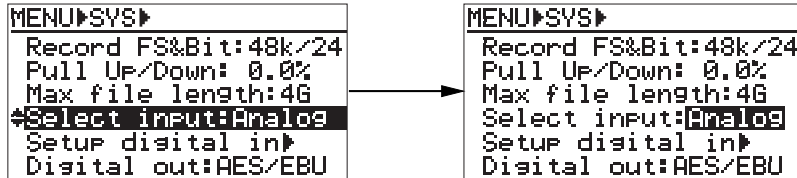

You can select between "Analog" and "Digital" (the default is "Analog").	
Analog	Analog audio signals fed to the [ANALOG INPUT] connectors are selected.
Digital	Digital audio signals fed to the [DIGITAL I/O] connector are selected.

Use the [MENU] dial to select the desired option and press the [ENTER/YES] key to confirm your setting. The current setting is shown in the status information area on the Home screen. Press the [STOP/HOME] key to exit the MENU mode.

Digital input channel setting [Setup digital in]

The "Setup digital in" menu item is effective when "Digital" is selected for the "Select input" menu item described above. This menu item selects the input channel sources between digital and analog for four channel pairs (channels 1-2, 3-4 and 5-6). The setting is stored to the Flash ROM of the unit.

Select the "Setup digital in" menu item and press the [ENTER/YES] key.

The display goes down to the "DIGITAL IN SELECT" screen. On this screen, you can select the input channel sources of four channel pairs.

Use the [MENU] dial to select a desired channel pair to be edited and press the [ENTER/YES] key. The current setting ("Analog" or "Digital") starts flashing.

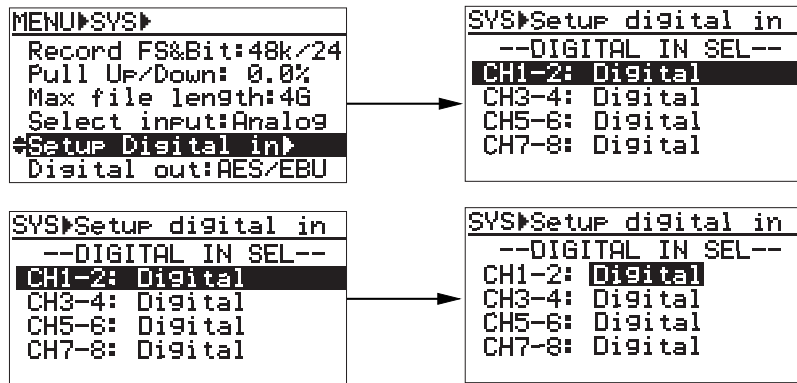

You can select between "Digital" and "Analog". (By default, all channel pairs are set to "Digital".)

Use the [MENU] dial to select "Digital" or "Analog", and press the [ENTER] key to confirm your setting. Press the [STOP/HOME] key to exit the MENU mode.

<Note>: You can make digital recording to channels which select "digital" in the "Digital in" menu item and lock to a digital clock while "Select input" is set to "Digital". If the channels do not lock to a digital clock, analog inputs are selected automatically regardless of the "Digital in" and "Select input" setting.

<Note>: The digital input signal format (AES/EBU or S/P DIF) is automatically detected by the unit.

Digital output signal format selection [Digital out]

The "Digital out" menu item selects the format (AES/EBU or S/P DIF) of the digital signal which is output from the [DIGITAL I/O] connector.

Select the "Digital out" menu item and press the [ENTER/YES] key.

The current setting starts flashing and you can now select the desired option.

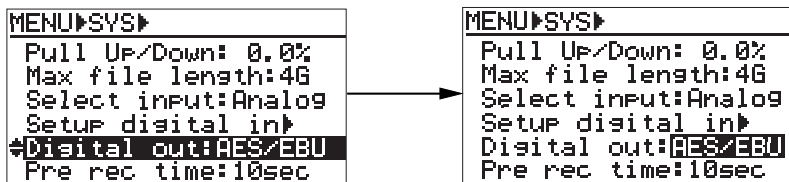

Selectable between "AES/EBU" and "S/P DIF" (the default is "AES/EBU").	
AES/EBU	IEC 60958 (AES/EBU) format digital signal is output.
SPDIF	IEC 60958 (S/P DIF) format digital signal is output.

Use the [MENU] dial to select the desired format and press the [ENTER/YES] key to confirm your setting. Press the [STOP/HOME] key to exit the MENU mode.

Pre recording time setting [Pre rec time]

The "Pre rec time" menu item sets the pre recording time of audio pooled in the buffer.

When starting recording while the Pre rec mode is set to "ON" (the [PRE REC] indicator lights), recording is made from the audio pooled in the buffer. This prevents missing the start of a take. The setting is stored to the Flash ROM of the unit.

Select the "Pre rec time" menu item and press the [ENTER/YES] key.

The current setting starts flashing and you can now select the desired time.

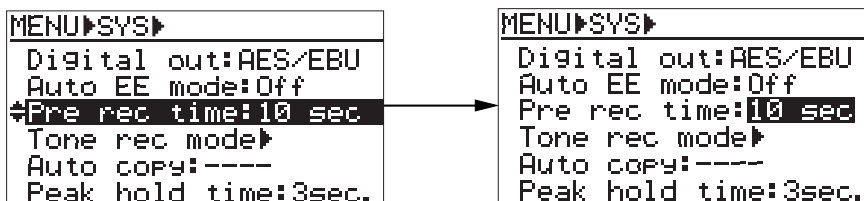

You can select time between "1 sec" and "10 sec" in one-second steps. (the default is "10 sec".)

Use the [MENU] dial to set the desired time and press the [ENTER/YES] key to confirm your setting. Press the [STOP/HOME] key to exit the MENU mode.

<Note>: If you execute pre recording at 88.2k or 96k FS, the pre recording time automatically reduces to half the selected value. For example, if the pre recording time is set to ten seconds, the buffer stores only five seconds of audio data.

Auto EE mode selection [Auto EE mode]

The "Auto EE mode" menu item selects "On" or "Off" of the auto EE mode. When set it to "On", "All input monitor" automatically turns on except during playback and cueing. The setting is stored to the Flash ROM of the unit.

Select the "Auto EE mode" menu item and press the [ENTER/YES] key. The current setting starts flashing and you can now select "On" or "Off".

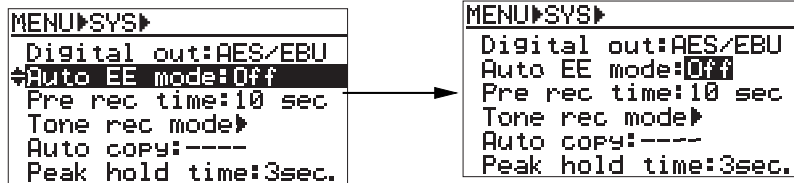

Selectable between "On" and "Off" (the default is "Off").	
On	"All input monitor" automatically turns on except during playback and cueing.
Off	You can switch on or off "All input monitor" using the [ALL INPUT] key.

Use the [MENU] dial to select "On" or "Off" and press the [ENTER/YES] key to confirm your setting. Press the [STOP/HOME] key to exit the MENU mode.

Slate tone/pop tone recording mode setting [Tone rec mode]

The "Tone rec mode" menu item sets the recording time and mode of the slate tone, as well as the recording mode of the pop tone. The slate tone is recorded at the beginning of a file, while the pop tone is recorded at the end of a file. The setting is stored to the Flash ROM of the unit. Select the "Tone rec mode" menu item and press the [ENTER/YES] key.

The display goes down to the "TONE REC MODE" screen. On this screen, you can make tone rec time, tone rec On/Off and end pop tone On/Off settings.

Use the [MENU] dial to select a desired setting item and press the [ENTER/YES] key. The current setting starts flashing.

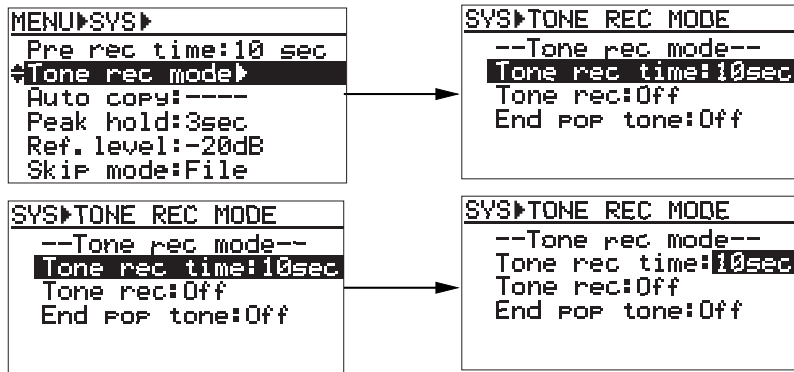

Use the [MENU] dial to select a desired option and press the [ENTER/YES] key to confirm your setting. Press the [STOP/HOME] key to exit the MENU mode.

Tone rec time setting

Selectable between "1sec" and "30sec" in one second steps (the default is "10sec").

Tone rec On/Off setting

Selectable from among "Off", "TONE" and "4 POP TONE" (the default is "Off").	
Off	No slate or pop tone is recorded.
TONE	The slate tone at 1 kHz is recorded for the duration set by "Tone rec time".
4 POP TONE	The pop tone at 1 kHz is recorded. The cycle of 0.5 sec tone and 0.5 sec mute recording is made four times repeatedly.

End pop tone On/Off setting

Selectable between "On" and "Off" (the default is "Off").	
On	The 1 kHz pop tone is recorded at the end of recording.
Off	The 1 kHz pop tone is not recorded at the end of recording.

Peak hold time setting [Peak hold]

The "Peak hold" menu item sets the peak hold time of the peak level meters. Select the "Peak hold" menu item and press the [ENTER/YES] key. The current setting starts flashing and you can now select the desired option.

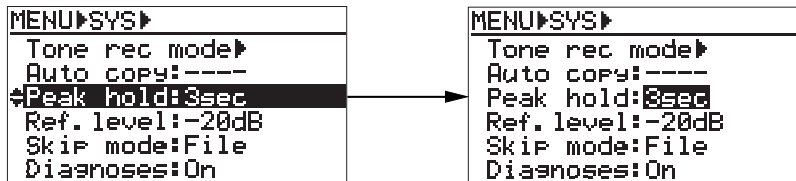

You can set the time between "0sec" and "9sec" in one second step or infinity (∞). The default is "3sec".

* When "∞" is selected, you can clear the peak hold indication by pressing the [CLEAR] key.

Use the [MENU] dial to set the desired time and press the [ENTER/YES] key to confirm your setting. Press the [STOP/HOME] key to exit the MENU mode.

Reference level setting [Reference level]

The "Reference level" menu item selects the reference input level. Select the "Reference level" menu item and press the [ENTER/YES] key. The current setting starts flashing and you can now select the desired option.

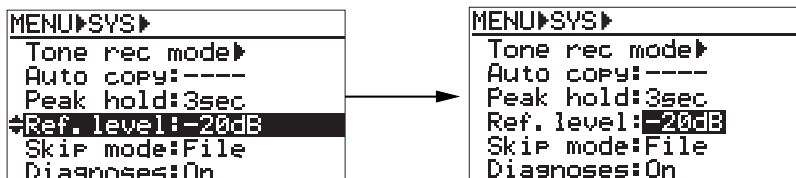

You can select from among "-20 dB", "-18 dB" or "-12 dB" (the default is "-20dB").

Use the [MENU] dial to set the desired level and press the [ENTER/YES] key to confirm your setting. Press the [STOP/HOME] key to exit the MENU mode.

The reference level setting is reflected to the level meters.

The associated level indicator with the selected level is lit.

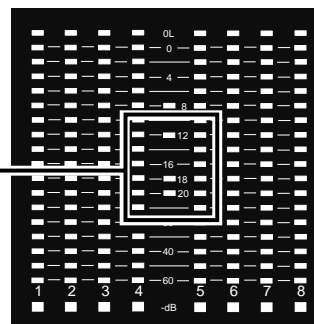

Skip mode setting [Skip mode]

The "Skip mode" menu item selects the skip mode ("File" or "CUE") of the [SKIP/CURSOR |<< >>|] keys.

Select the "Skip mode" menu item and press the [ENTER/YES] key.

The current setting starts flashing and you can now select the desired option.

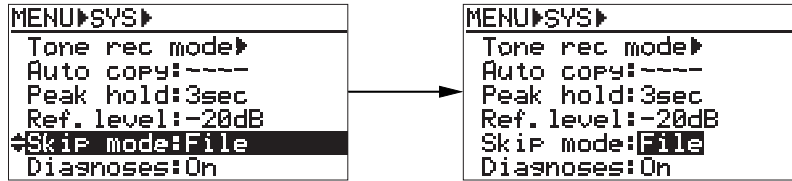

You can select between "File" and "Cue" (the default is "File").	
File	You can skip between audio files in order of creation date. Therefore, you can select a desired audio file using the [SKIP/CURSOR] keys.
Cue	You can skip to the previous or next cue point in the ABS time order.

Use the [MENU] dial to select the desired option and press the [ENTER/YES] key to confirm your setting. Press the [STOP/HOME] key to exit the MENU mode.

Diagnoses file setting [diagnoses]

The "diagnoses" menu item selects whether or not creating a diagnoses file which logs errors during recording, etc. The setting is stored to the Flash ROM of the unit.

Select the "diagnoses" menu item and press the [ENTER/YES] key.

The current setting starts flashing and you can now select the desired option.

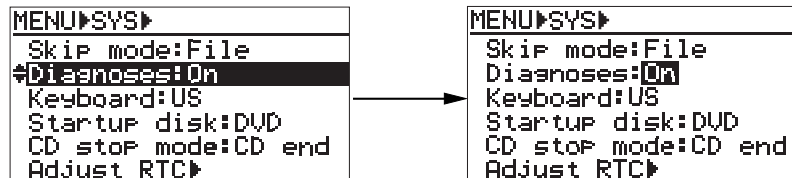

You can select between "On" and "Off" (the default is "On").	
On	Creates a diagnoses file which logs errors during recording, etc.
Off	Does not create a diagnoses file.

Use the [MENU] dial to select the desired option and press the [ENTER/YES] key to confirm your setting. Press the [STOP/HOME] key to exit the MENU mode.

USB keyboard type setting [Keyboard]

The "Keyboard" menu item selects the type of a USB keyboard connected to the [USB] connector. The setting is stored to the Flash ROM of the unit.

Select the "Keyboard" menu item and press the [ENTER/YES] key.

The current setting starts flashing and you can now select the desired option.

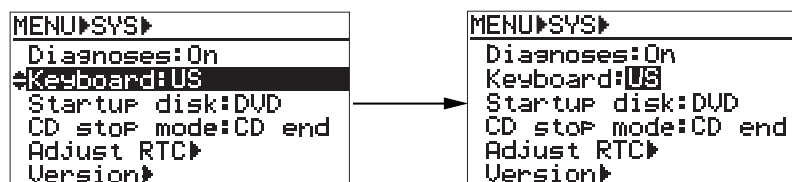

You can select between "US" and "JAPAN" (the default is "US").	
US	A US keyboard can be connected. This is the default.
JAPAN	A Japanese keyboard can be connected.

Use the [MENU] dial to select the desired option and press the [ENTER/YES] key to confirm your setting. Press the [STOP/HOME] key to exit the MENU mode.

Startup disk selection [Startup disk]

The "Startup disk" menu item selects the medium started up when turning on the power. The setting is stored to the Flash ROM of the unit. If the optional hard disk drive is installed, you can also select a hard disk partition.

Select the "Startup disk" menu item and press the [ENTER/YES] key. The current setting starts flashing and you can now select the desired option.

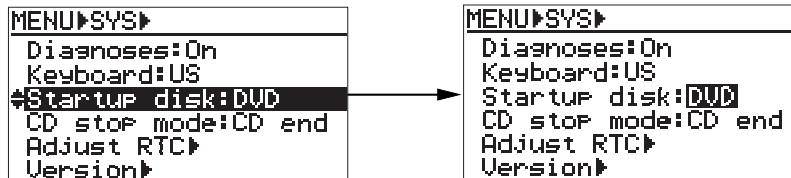

You can select from among "DVD", "AUTO" and "PT01" through "PT08" (the default is "DVD").	
DVD	Starts up with the DVD-RAM drive.
AUTO	Starts up with a drive (or partition) selected when turning off the power last time.
PT01 ~ PT08	Starts up with the selected hard disk partition (only available when the optional hard disk drive is fitted to the unit).

<Note>: "PT01" through "PT08" (hard disk partitions) and "AUTO" can be selected only when the optional hard disk drive (Model 9057) is installed.

Use the [MENU] dial to select the desired option and press the [ENTER/YES] key to confirm your setting. Press the [STOP/HOME] key to exit the MENU mode.

ROM version checking [Version]

Selecting "Version" allows you to view the software ROM version number and creation/revision date.

Select the "Version" menu item and press the [ENTER/YES] key. The current setting starts flashing and you can now select the desired option.

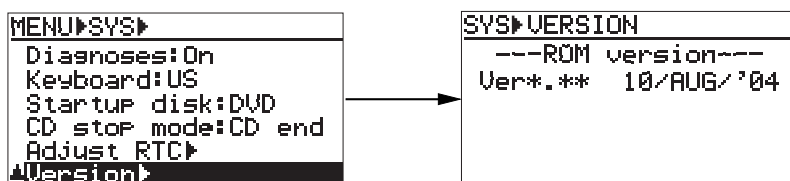

To exit the MENU mode, press the [STOP/HOME] key.

TC SETUP menu

In the TC SETUP menu, 16 menu items for settings regarding time code recording/playback and synchronization to an external device are available. These settings are valid when the optional TC/SYNC card is installed to the unit.

<Note>: Details of the "Force JAM" menu item are described in "Advanced operations". See page 81 for details.

Menu item	Setting/function	Default
Sync Clock	Selects the system clock.	INT
Frame Rate	Selects the time code frame rate.	25
Gen Mode	Selects the generator mode of the internal TC generator.	Rec Run
Set Gen TC	Sets TC generator start time and userbit when the generator mode is set to Free Run or Rec Run.	-
* Force JAM	Executes Force Jam to external time code while the generator mode is set to Free Run.	-
JAM mode	Selects the Jam mode when the generator mode is set to Free Run.	BOTH
Gen Ubit	Selects userbit of output time code.	<User>
Sel. TC OUT	Selects output time code source.	Repro
Default LTC start	Sets the default LTC start time when no external time code is fed to the unit.	1h 00m 00s
Edit LTC Start	Sets the LTC start time of a playback file.	-
Rep TC Ubit	Sets userbit of playback time code.	EEEEERRR
Rep Pause TC	Selects On/Off of time code output while paused.	Off
Ref TC Sel	Selects the reference time code.	LTC
Chase Mode	Selects the chase mode of the unit against the reference time code.	Once
Chase Offset	Sets chase offset value.	-
BiPhase Setup	Makes settings required for synchronizing to a film machine.	-

Basic procedure for using the "TC SETUP" menu

The basic procedure for using the "TC SETUP" menu is as described below.

1) While the unit is stopped, press the [ENTER/YES] key.

The unit enters the MENU mode and the MENU list screen as below is shown.
When "▼" is shown, you can scroll the screen downward.
The item with "▶" on the right has the next level screen.

```

MENU▶
▼SYS SETUP▶
  TC SETUP▶
  DISK UTILITY▶
  TCP/IP SETUP▶
  RS422 SETUP▶
  FILE SEL▶
  
```

2) Use the [MENU] dial to select "TC SETUP" and press the [ENTER/YES] key.

The display now shows the TC SETUP menu screen ("Sync clock" is initially highlighted).

<pre> MENU▶ SYS SETUP▶ ▶TC SETUP▶ DISK UTILITY▶ TCP/IP SETUP▶ RS422 SETUP▶ FILE SEL▶ </pre>	→	<pre> MENU▶TC SETUP▶ ▼Sync clock:INT Frame rate:25 Gen mode:Rec Run Set Gen.TC▶ Force JAM▶ JAM mode:BOTH </pre>
---	---	---

3) Use the [MENU] dial to select the desired menu item and press the [ENTER/YES] key.

The display now shows the first level screen of the selected menu item.

Selecting a menu item with "▶" on the right brings up the second level screen.

If you select a menu item without "▶", the current setting flashes and you can now make selection on the first level screen.

For details of setting for each item, see the following pages.

Example of a menu item which has the second level screen
(Selecting the item brings up the second level screen.)

<pre> MENU▶TC SETUP▶ Force JAM▶ JAM mode:BOTH Gen Ubit:<User> Sel. TC Out:Rerro ▶Default LTC start▶ Edit LTC start▶ </pre>	→	<pre> TC SETUP▶Default TC --LOOKUP DEFAULT TC-- 01h00m00s Edit: ENTER Key Exit: EXIT Key </pre>
--	---	--

Example of a menu item of which you can make setting on the first level screen
(The current setting flashes.)

<pre> MENU▶TC SETUP▶ ▼Sync clock:INT Frame rate:25 Gen mode:Rec Run Set Gen.TC▶ Force JAM▶ JAM mode:BOTH </pre>	→	<pre> MENU▶TC SETUP▶ Sync clock:INT Frame rate:25 Gen mode:Rec Run Set Gen.TC▶ Force JAM▶ JAM mode:BOTH </pre>
---	---	--

Pressing the [EXIT/NO] key goes up the level one by one. Therefore, you can exit the MENU mode by pressing the [EXIT/NO] key repeatedly. You can, however, exit the MENU mode directly by pressing the [STOP/HOME] key.

System clock selection [Sync clock]

Using the "Sync clock" menu item, you can select the system clock reference. If you connect the DV824 to an external digital or video machine which does not have sync clock output facility, use the DV824 internal clock as the system master clock. You can also set the system clock reference using the quick setup mode.

Select the "Sync clock" menu item and press the [ENTER/YES] key. The current setting starts flashing and you can now select the desired option.

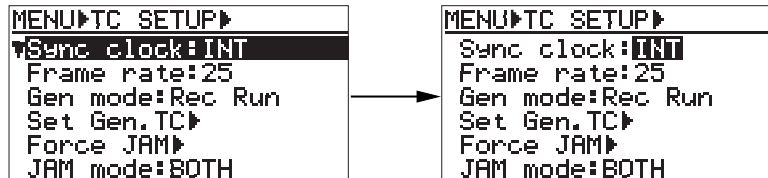

Use the [MENU] dial to select the desired option, and press the [ENTER/YES] key to confirm your setting. Press the [STOP/HOME] key to exit the MENU mode.

Options	Details
INT	The unit is referenced to the internal clock master (default setting).
Video	The unit is referenced to external video clock received from the [WORD INPUT] connector (available only when the optional TC/SYNC card is installed).
Word	The unit is referenced to external word clock.
Digi in	The unit is referenced to digital audio input signal.

<Note>: The "Video" option is available only when the optional TC/SYNC card is installed.

TC frame rate selection [Frame rate]

Using the "Frame rate" menu item, you can select the time code frame rate for recording. You can also select the TC frame rate using the quick setup mode.

Select the "Frame rate" menu item and press the [ENTER/YES] key. The current setting starts flashing and you can now select the desired option.

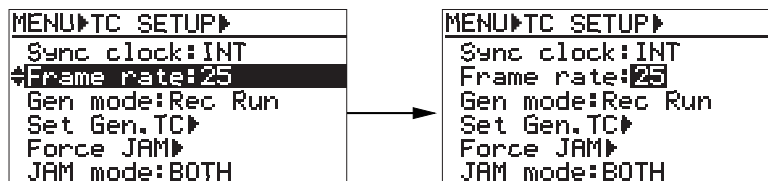

Use the [MENU] dial to select the desired option, and press the [ENTER/YES] key to confirm your setting. Press the [STOP/HOME] key to exit the MENU mode.

Options	Details
23.97	American motion picture -0.1%
24	American motion picture
25	European film/PAL-SECAM video EBU (default setting)
29.97	NTSC color
29.97DF	NTSC color with real time adjust
30	NTSC video/film
30DF	NTSC video/film

Generator mode selection [Gen mode]

Using the "Gen mode" menu item, you can select the generator mode of the internal TC generator. You can also select the TC frame rate using the quick setup mode.

<Note>: In the "Gen mode" menu item setting, the "Free Run" and "24H Run" options are not available when the optional TC/SYNC card is not installed. When the card is not installed, you can set the LTC recording mode and can select the "Rec Run" or "Ext Run" option (see page 47).

Using the "Gen mode" menu item, you can select the generator mode for time code recording. You can also select the generator mode using the quick setup mode.

Select the "Gen mode" menu item and press the [ENTER/YES] key.

The current setting starts flashing and you can now select the desired option.

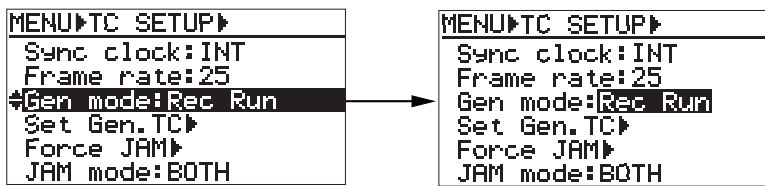

Use the [MENU] dial to select the desired option, and press the [ENTER/YES] key to confirm your setting. Press the [STOP/HOME] key to exit the MENU mode.

Options	Details
Rec Run	When recording, the unit records time code which continues from the last time code value of the previous audio file. If you change to a new disk which does not have any audio file and make recording, the unit records time code which continues from the last time code value of the most recent audio file on the disk previously set (default setting).
Ext Run	When recording, the unit records the incoming external time code. If the TC/SYNC card is not installed or the unit does not receive external time code, the unit always records the Default LTC start time at the beginning of the file.
Free Run	When recording, the unit records time code generated by the internal generator which runs freely.
24H Run	When recording, the unit records time code based on the current internal RTC (real-time clock) time.

Internal TC generator setting [Set Gen TC]

Using the "Set Gen TC" menu item, you can view the current generator mode, time code value and userbit value of the internal TC generator, as well as you can edit the time code start time for the "Rec Run" mode and the userbit value for the "Free Run" mode.

- 1) **Select the "Set Gen TC" menu item and press the [ENTER/YES] key.**

The screen goes down to the "Set Gen TC" screen. You can view the current generator mode, time code value and userbit value of the internal TC generator.

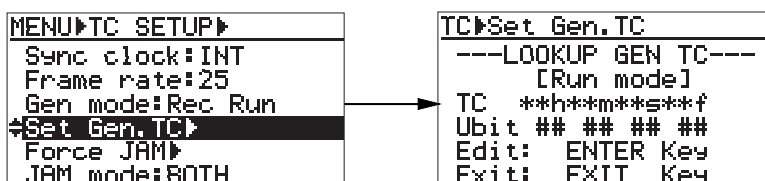

<Notes>

- Under "LOOKUP GEN TC", the current generator mode is shown (in the screen example above, "[Run mode]" is shown).
- If no time code is fed to the unit in the "EXT RUN" mode, "<<No EXT TC!>>" is shown.
- In the "Rec Run" or "24H Run" mode, user bit is not shown.
- In the "Rec Run" mode, the "TC" field shows "--h--m--s--f".

If you just view the information and do not make any editing, press the [EXIT/NO] key to exit the TC SETUP menu.

Only when the TC generator mode is set to "Free Run", "Rec Run" or "24H Run", you can edit the start time by following the procedure below.

2) Press the [ENTER/YES] key.

The screen goes down to the editing screen, as shown below.
The frame value of time code flashes.

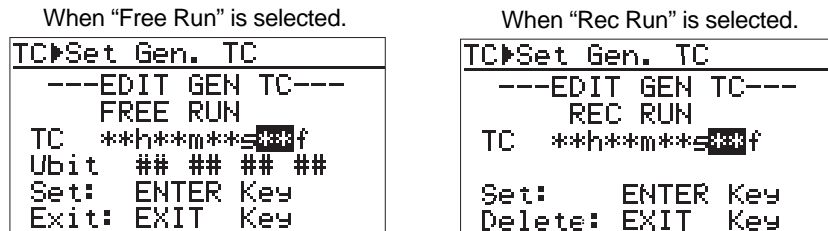

3) Enter the desired time code value (and userbit value), and press the [ENTER/YES] key to confirm your setting.

Pressing the [CLEAR] key clears the time value to zero.

Use the [MENU] dial (or the alphanumeric keys) to enter a desired value and use the [SKIP/CURSOR I◀◀▶▶I] keys to move the cursor position.

When the editing screen (as shown on the right above) is shown In the "Rec Run" mode, pressing the [EXIT/NO] key resets the time code value to "--h--m--s--f".

<Note>: Only when the TC generator mode is set to "Free Run" and the generator userbit is set to "<user>", you can edit the userbit value in the same manner as editing the time code start time value.

<Note>: In the "Rec Run" mode, time code starts from the edited value when starting recording a new file.

Jam mode setting [JAM mode]

Using the "JAM mode" menu item, you can select the jam mode for the generator "Free Run" mode (You can set which information is jammed).

<Note>: The "JAM mode" menu item setting is effective only when the optional TC/SYNC card is installed. When it is not installed, "Void! No TC Card" is shown and you cannot make setting.

Select the "JAM mode" menu item and press the [ENTER/YES] key. The current setting starts flashing and you can now select the desired option.

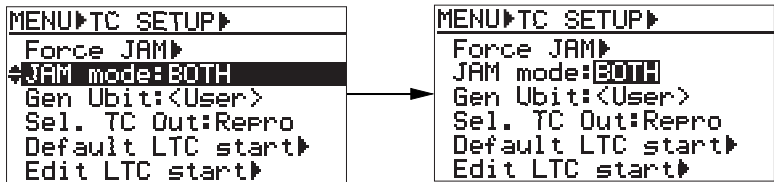

Use the [MENU] dial to select the desired option, and press the [ENTER/YES] key to confirm your setting. Press the [STOP/HOME] key to exit the MENU mode.

Options	Details
BOTH	Both time code and userbit data are jammed (default setting).
TC	Only time code data is jammed. For userbit, the userbit data of the internal generator is used.
UBIT	Only the userbit data is jammed. For time code, the time code data of the internal generator is used.

User bit setting [Gen Ubit]

Using the "Gen Ubit" menu item, you can set the time code userbit value which is output from the [TIME CODE OUT] connector when the "Sel TC Out" menu item is set to "Gen".

<Note>: The "Gen Ubit" menu item setting is effective only when the optional TC/SYNC card is installed. When it is not installed, "Void! No TC Card" is shown and you cannot make setting.

Select the "Gen Ubit" menu item and press the [ENTER/YES] key. The current setting starts flashing and you can now select the desired option.

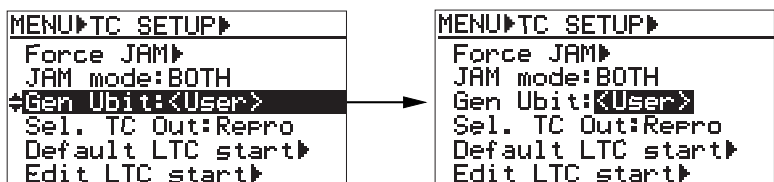

Use the [MENU] dial to select the desired option, and press the [ENTER/YES] key to confirm your setting. Press the [STOP/HOME] key to exit the MENU mode.

Options	Details
<User>	The default is 00 00 00 00 (default setting).
MMDDYY00	BG_76:MM (month)/ BG_54:DD (day)/ BG_32:YY (year)/ BG_10:xx (US)
DDMMYY00	BG_76:DD (day)/ BG_54:MM (month)/ BG_32:YY (year)/ BG_10:xx (EUR)

Time code output source selection [Sel. TC Out]

Using the "Sel. TC Out" menu item, you can set the time code source (Repro or Gen) fed from the [TIME CODE OUT] connector.

<Note>: The "Sel. TC Out" menu item setting is effective only when the optional TC/SYNC card is installed. When it is not installed, "Void! No TC Card" is shown and you cannot make setting.

Select the "Sel. TC Out" menu item and press the [ENTER/YES] key.

The current setting starts flashing and you can now select the desired option.

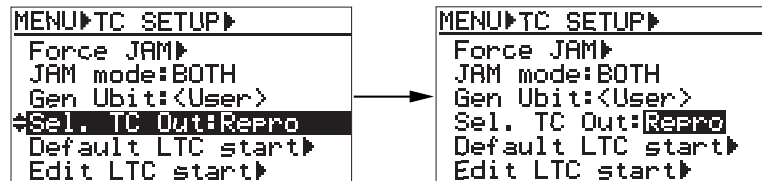

Use the [MENU] dial to select the desired option, and press the [ENTER/YES] key to confirm your setting. Press the [STOP/HOME] key to exit the MENU mode.

Options	Details
Repro	Outputs playback time code. This is the default.
Gen	Outputs the internal generator time code.

<Note>: Even if "Sel. TC Out" is set to "Gen", the generator time code is not output when the generator mode is set to the "EXT RUN" mode.

Default LTC start time setting [Default LTC start]

Using the "Default LTC start" menu item, you can set the desired default LTC start time value (the initial setting is "1h 00m 00s"). This value is used when the generator mode is set to "Ext Run" but no external time code is fed to the unit.

<Note>: The unit does not recognize paused time code as "correct" time code. It recognizes time code when receiving more than two continuous frames.

- 1) **Select the "Default LTC start" menu item and press the [ENTER/YES] key.**
The current LTC start time is shown (initially, "1h 00m 00s" is shown).

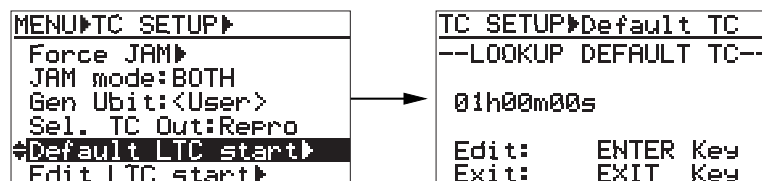

- 2) **Press the [ENTER/YES] key again.**
The second value flashes and you can now edit the default LTC start time.

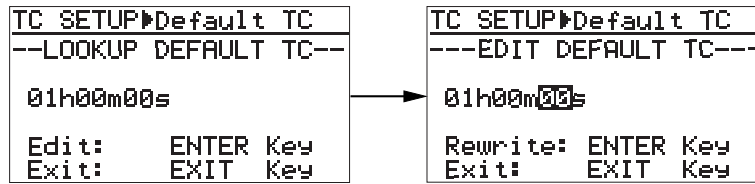

- 3) **Edit the time value to the desired value, and press the [ENTER/YES] key to confirm your setting.**

Use the [MENU] dial (or the alphanumeric keys) to enter a desired value and use the [SKIP/CURSOR |◀▶|] keys to move the cursor position. The setting is stored to the Flash ROM of the unit.

LTC start time editing [Edit LTC start]

Using the "Edit LTC start" menu item, you can set the desired LTC start time of a playback audio file. The LTC start time is recorded to the currently load file.

<Note>: The DV824 records only the start time of LTC, and the internal generator generates and outputs LTC with reference to the start time. On a "BWF" file, the start time is recorded as "Time Reference" in "Broadcast Audio Extension Chunk". Therefore, if you want to use this LTC in Digidesign Pro Tools, export the audio file to Pro Tools and make "User Time Code" effective.

- 1) **Select the "Edit LTC start >" menu item and press the [ENTER/YES] key.**
The LTC start time recorded on the current file is shown.

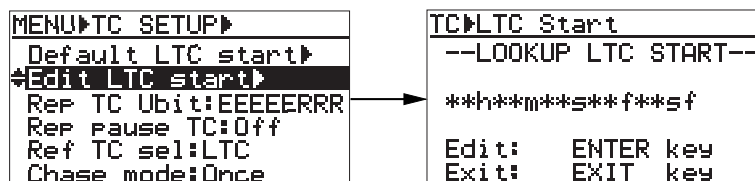

- 2) **Press the [ENTER/YES] key again.**
Initially, the subframe value flashes and you can now edit the LTC start time.

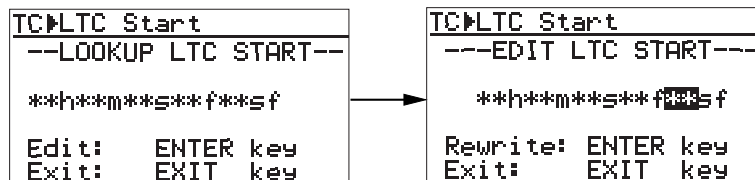

- 3) **After editing the start time, press the [ENTER/YES] key to confirm your setting.**
Use the [MENU] dial (or the alphanumeric keys) to enter a desired value and use the [SKIP/CURSOR |◀▶|] keys to move the cursor position.

UBIT setting of playback time code [RepTC Ubit]

Using the "RepTC Ubit" menu item, you can select the desired userbit of time code which is output from the [TIME CODE OUT] connector while the [Sel TC Out] is set to "Repro".

- 1) **Select the "RepTC Ubit" menu item and press the [ENTER/YES] key.**

The currently selected time code userbit flashes (the default is "EEEEERRR"). You can now select the userbit.

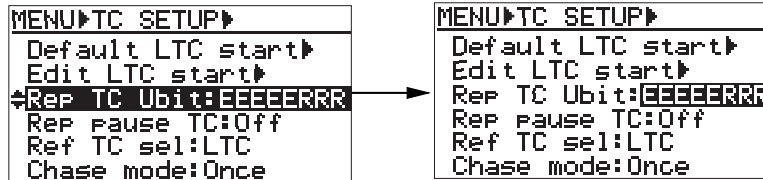

- 2) **Use the [MENU] dial to select the desired TC userbit and press the [ENTER/YES] key to confirm your selection.**

You can select the desired userbit from the following.

EEEEERRR	BG_76543: EEEEE / BG_210: RRR (default setting)
MMDDYYff	BG_76: MM (month)/BG_54: DD (day)/BG_32:YY (year)/BG_10: ff (US)
DDMMYYff	BG_76: DD (day)/BG_54: MM (month)/BG_32:YY (year)/BG_10: ff (EUR)
SSSSSRRR	BG_756432: SSSSSS / BG_10: RR
RRREEEEE	BG_756: RRR / BG_54321: EEEEE
SSSSSSTT	BG_756432: SSSSSS / BG_01: TT
<BWF UBIT>	Outputs the userbit in the BWF descriptor information.
<p>EEEE:EVENT No: Only the lower five figures of the numeral information in the event information recorded on BWF are output from the rightmost five digits of the user bit fields.</p> <p>RRR:REEL No: Only the lower three figures of the reel number recorded on BWF are output from the rightmost three digits of the user bit fields.</p> <p>RR:REEL No: Only the lower two figures of the reel number recorded on BWF are output from the rightmost two digits of the user bit fields.</p> <p>SSSSSS:SCENE No: Only the lower six figures of the scene number recorded on BWF are output from the rightmost six digits of the user bit fields.</p> <p>TT:Take No: Only the lower two figures of the take number recorded on BWF are output from the rightmost two digits of the user bit fields.</p> <p>ff: File No (in decimal, 01 to 99)</p>	
<p><Notes></p> <ul style="list-style-type: none"> • Date information (year, month and day) shows the original date of an audio file. • The event number, reel number, scene number, and take number must be set using the appropriate menu items in advance. 	

Time code output while paused [Rep pause TC]

Using the "Rep pause TC" menu item, you can select whether time code is output from the [TIME CODE OUTPUT] connector or not while the recorder is paused.

<Note>: The "Rep pause TC" menu item setting is effective only when the optional TC/SYNC card is installed. When it is not installed, "Void! No TC Card" is shown and you cannot make setting.

Select the "Rep pause TC" menu item and press the [ENTER/YES] key. The current setting starts flashing and you can now select "On" or "Off".

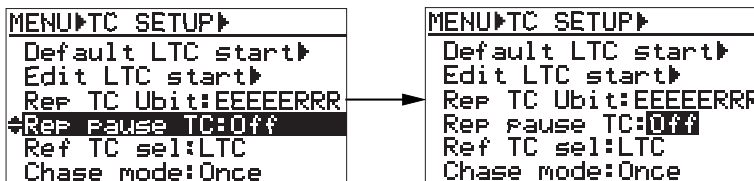

Use the [MENU] dial to select "On" or "Off", and press the [ENTER/YES] key to confirm your setting. Press the [STOP/HOME] key to exit the MENU mode.

Options	Details
On	When the "Sel TC Out" menu item is set to "Repro" and the unit is stopped (or paused), a paused time code value (same time code value) is output intermittently.
Off	When the "Sel TC Out" menu item is set to "Repro" and the unit is stopped (or paused), no time code is output (default setting).

Reference time code selection [Ref TC sel]

Using the "Ref TC sel" menu item, you can select the time code reference between LTC and Biphase pulse.

<Note>: The "Ref TC sel" menu item setting is effective only when the optional TC/SYNC card is installed. When it is not installed, "Void! No TC Card" is shown and you cannot make setting.

Select the "Ref TC sel" menu item and press the [ENTER/YES] key. The current setting starts flashing and you can now select the option.

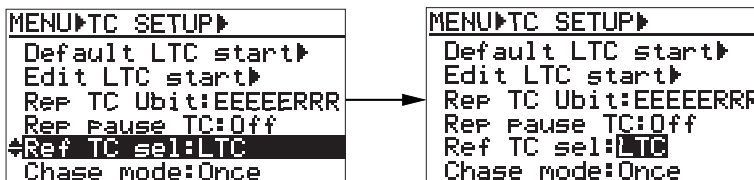

Use the [MENU] dial to select the desired option, and press the [ENTER/YES] key to confirm your setting. Press the [STOP/HOME] key to exit the MENU mode.

Options	Details
LTC	The unit is referenced to LTC fed to the [TIME CODE IN] connector (default setting).
BiPhase	The unit is referenced to BiPhase pulse fed to the [BI-PHASE INPUT] connector.

Chase mode selection [Chase mode]

Using the "Chase mode" menu item, you can select the chase mode to the reference time code.

<Note>: The "Chase mode" menu item setting is effective only when the optional TC/SYNC card is installed. When it is not installed, "Void! No TC Card" is shown and you cannot make setting.

Select the "Chase mode" menu item and press the [ENTER/YES] key. The current mode starts flashing and you can now select the option.

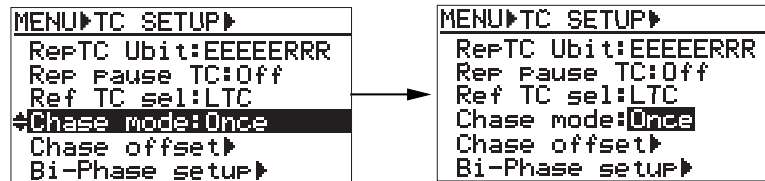

Use the [MENU] dial to select the desired mode, and press the [ENTER/YES] key to confirm your setting. Press the [STOP/HOME] key to exit the MENU mode.

Options	Details
Once	In this mode, once the unit locks to the incoming reference time code after activating the chase mode, it stops chasing and runs freely, ignoring the incoming time code. The unit does not rebase the time code even if it runs out of sync to the time code (default setting).
Continue	In this mode, once the unit locks to the incoming time code after activating the chase mode, it stops chasing and runs freely. The unit rebases the incoming time code if it runs out of sync to the time code.
Frame Sync	In this mode, after the unit locks to the incoming time code, it continues to check the incoming time code and control the speed to keep locking to the incoming time code by using the small amount of varispeed which is inaudible. The unit rebases the incoming time code if it runs out of sync to the time code.

To make the unit chase to the reference time code, press the [CHASE] key on the front panel to activate the chase mode. When activating the chase mode, the [CHASE] indicator starts flashing. When the unit locks to the reference time code, the [CHASE] indicator is steadily lit.

Chase offset setting [Chase offset]

Using the "Chase offset" menu item, you can make chase offset editing, chase offset trimming and catch offset.

<Note>: The "Chase offset" menu item setting is effective only when the optional TC/SYNC card is installed. When it is not installed, "Void! No TC Card" is shown and you cannot make setting.

Chase offset editing

- 1) **Select the "Chase offset" menu item and press the [ENTER/YES] key.**

The display goes down to the Chase offset screen, as show below.

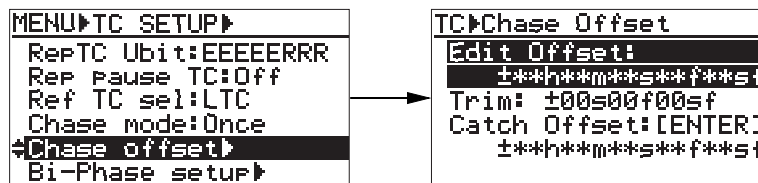

In the Chase offset screen, the following items are shown.

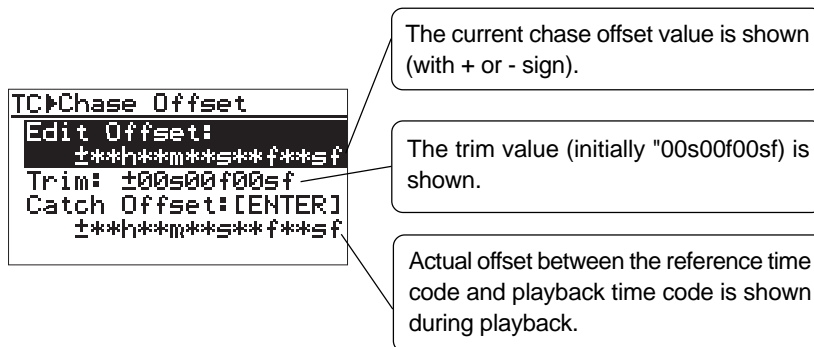

- 2) **Press the [ENTER/YES] key again.**

Initially, the subframe value of the "Edit offset" flashes and you can now edit the offset value.

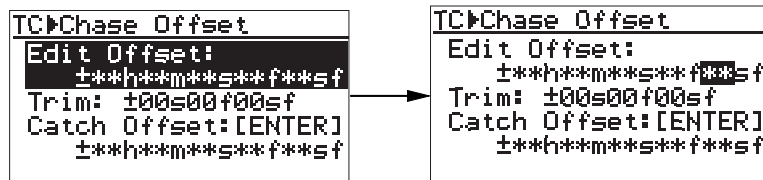

- 3) **Use the [MENU] dial (or the alphanumeric keys) to enter the desired offset value and press the [ENTER/YES] key to confirm your setting.**

Use the [SKIP/CURSOR I<<>>] keys to move the cursor position.

You can set a value between "-12h00m00s**f00sf" and "11h59m59s**f99sf" ("**" is one smaller than the frame rate number). Unlike ordinary time editing, you can also set "+" or "-" sign.

Chase offset trimming

While the unit is chasing and locking to the master, you can trim the chase offset in realtime.

<Note>: You can trim the chase offset only when the unit is chasing an external machine and locking to the master. In other conditions, you cannot execute the following operation.

- 1) Use the [MENU] dial to select "Trim" and press the [ENTER/YES] key.
Initially, the subframe value flashes and you can now trim the offset value.

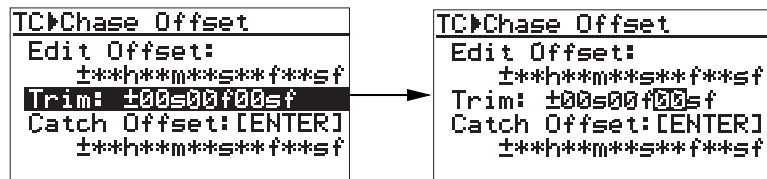

- 2) Use the [MENU] dial to trim the offset value and press the [ENTER/YES] key to confirm your setting.
You can set a value between "-59s **f 99sf" and "+59s **f 99sf" ("**" is one smaller than the frame rate number).

<Notes>

- After trimming the value, do not forget to press the [ENTER/YES] key. If you do not press the [ENTER/YES] key and exit the MENU mode, the trimming operation is ignored and the value returns to the previous one.
- The trimming is reflected to the offset value shown on the screen.

Catch offset

Using the "Catch Offset" function, you can capture the current offset value between the incoming master time code and the playback time code, and set it to the chase offset value. This function is available both during playback and while stopped.

- 1) Use the [MENU] dial to select "Catch Offset?" and press the [ENTER/YES] key.
The current offset value when pressing the [ENTER/YES] key is set to the chase offset value.

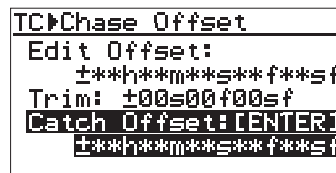

- 2) Press the [STOP/HOME] key to exit the MENU mode.

Synchronization to a film machine [Bi-Phase setup]

When the optional TC/SYNC card is installed to the unit, you can set the following items for synchronizing the unit to a film machine.

- 1) Resetting the current film position to the start position
- 2) Editing the film start time
- 3) Setting the number of pulses per frame
- 4) Setting the film leader length and film size

<Note>: The "Bi-Phase setup" menu item setting is effective only when the optional TC/SYNC card is installed. When it is not installed, "Void! No TC Card" is shown and you cannot make setting.

- 1) **Select the "Bi-Phase setup" menu item and press the [ENTER/YES] key.**

The display goes down to the Bi-phase setup screen, as show below.

On this screen, you can make settings for synchronizing the unit to a film machine.

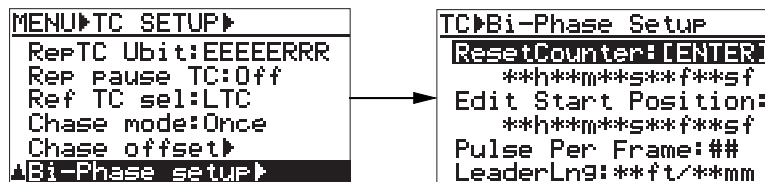

In the Bi-phase setup screen, the following items are shown.

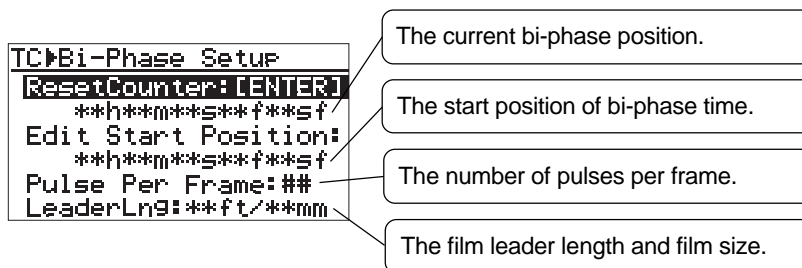

Resetting the current film position to the start time

This item is used to reset the current position to the start time.

- 1) **While "ResetCounter" is highlighted, press the [ENTER/YES] key.**

The current position shown on the screen is set to the start time which is shown in the "Edit Start Position" field.

In the screen example below left, the current film position is "00h03m00s00sf" and the start time is "00h10m00s00sf". If you press the [ENTER/YES] key, the current film position is reset to "00h10m00s00sf" as shown below right.

By operating above after editing the start time (see the next page), you can reset the film position to the desired start time.

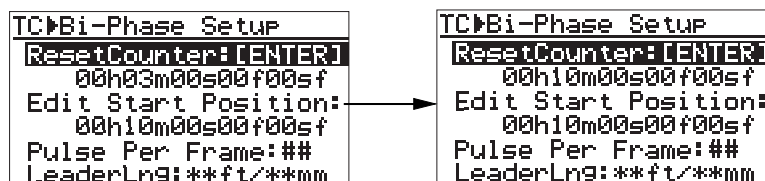

Editing the film start time

You can edit the film start time.

- 1) Use the [MENU] dial to highlight "Edit Start Position" and press the [ENTER/YES] key. The subframe value of the current start time starts flashing and you can now edit the start time.

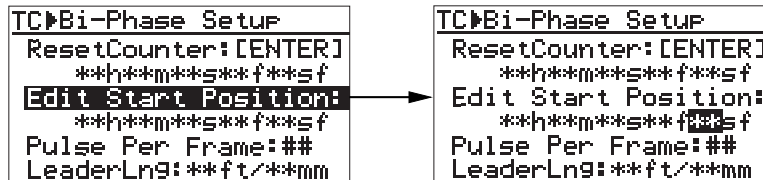

- 2) Use the [MENU] dial (or the alphanumeric keys) to enter the desired start time and press the [ENTER/YES] key to confirm your setting.

You can move the cursor position using the [SKIP/CURSOR |◀◀ ▶▶|] keys.

The start time confirmed by pressing the [ENTER/YES] key is stored to the Flash ROM of the unit.

Setting the number of pulses per frame

You can set the number of pulses per frame within the range between 1 and 100 (the default is "1").

- 1) Use the [MENU] dial to highlight "Frame Par Pulse" and press the [ENTER/YES] key.

The current setting starts flashing and you can now edit it.

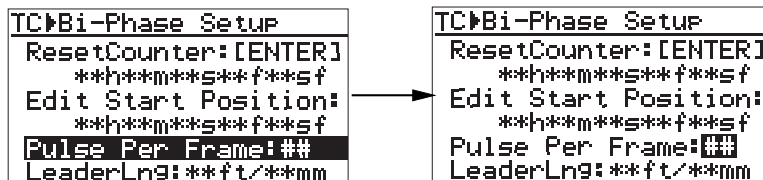

- 2) Use the [MENU] dial (or the alphanumeric keys) to enter the desired value and press the [ENTER/YES] key to confirm your setting.

Setting the film leader length and film size

You can set the film leader length and film size (the default is "0 feet").

- 1) Use the [MENU] dial to highlight "LeaderLng" and press the [ENTER/YES] key. The current setting starts flashing and you can now select the desired option. You can select from among "0 feet", "12ft/16mm", "12ft/35mm" and "15ft/35mm".

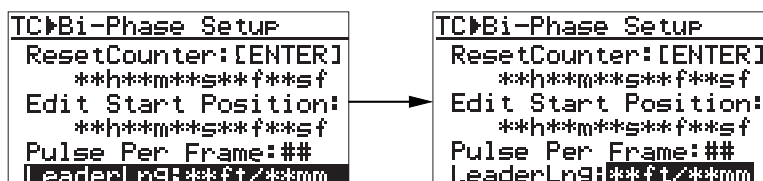

- 2) Use the [MENU] dial to select the desired option and press the [ENTER/YES] key to confirm your setting.

DISK UTILITY menu

In the DISK UTILITY menu, 12 menu items for settings regarding recording media and recorded audio files are available. This section explains the following ten menu items in the table below. For the "File Copy" and "Disk Copy" menu items in the DISK UTILITY menu, see pages shown below.

Menu item	Setting/function	Default
Edit File Name	Edits the audio file name.	-
File Info.	Views audio file information and edits descriptor information.	-
Delete File	Deletes an unnecessary file.	-
Restore Del File	Restores a deleted file.	-
Optimize Disk	Optimizes a DVD-RAM disk or a partition of the optional hard disk drive.	-
Format	Formats a DVD-RAM disk or a partition of the internal hard disk drive.	-
Reel No.	Edits a reel No. (volume label) of an audio file	S0001
Rec Protect	Selects on/off of the record protection of an audio file.	Off
Resume	Selects on/off of the resume function of an audio file.	Off
Part Protect	Selects on/off of the record protection of a partition of the internal hard disk drive.	Off
* File copy	See page 87 for details.	-
* Disk copy	See page 86 for details.	-

Basic procedure for using the "DISK UTILITY" menu

The basic procedure for using the "DISK UTILITY" menu is as described below.

- 1) **While the unit is stopped, press the [ENTER/YES] key.**
The unit enters the MENU mode and the MENU list screen as below is shown.
When "▼" is shown, you can scroll the screen downward.
The item with "▶" on the right has the next level screen.

```

MENU▶
▼SYS SETUP▶
TC SETUP▶
DISK UTILITY▶
TCP/IP SETUP▶
RS422 SETUP▶
FILE SEL▶
  
```

- 2) **Use the [MENU] dial to highlight "DISK UTILITY" and press the [ENTER/YES] key.**
The display now shows the DISK UTILITY menu screen.

```

MENU▶
SYS SETUP▶
TC SETUP▶
▶DISK UTILITY▶
TCP/IP SETUP▶
RS422 SETUP▶
FILE SEL▶
  
```

→

```

MENU▶DISK UTILITY▶
▼Edit file name▶
File info.▶
Delete file▶
Restore Del. file▶
Optimize disk▶
Format▶
  
```

- 3) **Use the [MENU] dial to select the desired menu item and press the [ENTER/YES] key.**
The display now shows the first level screen of the selected menu item.
Selecting a menu item with "▶" on the right brings up the next level screen.
If you select a menu item without "▶", the current setting flashes and you can now make selection on the first level screen.
For details of setting for each item, see the following pages.

Example of a menu item which has the next level screen
(Selecting the item brings up the next level screen.)

```

MENU▶DISK UTILITY▶
▼Edit file name▶
File info.▶
Delete file▶
Restore Del. file▶
Optimize disk▶
Format▶
  
```

→

```

UTILITY▶File name
---EDIT FILE NAME---
File No:***
[C]*****.wav
  
```

Example of a menu item of which you can make setting on the first level screen
(The current setting flashes.)

```

MENU▶DISK UTILITY▶
Restore Del. file▶
Optimize disk▶
Format▶
Reel No:[***** ]
▶Rec protect: Off
Resume: Off
  
```

→

```

MENU▶DISK UTILITY▶
Restore Del. file▶
Optimize disk▶
Format▶
Reel No:[***** ]
Rec protect: [Off]
Resume: Off
  
```

Pressing the [EXIT/NO] key goes up the level one by one. Therefore, you can exit the MENU mode by pressing the [EXIT/NO] key repeatedly. You can, however, exit the MENU mode directly by pressing the [STOP/HOME] key.

Editing a file name [Edit file name]

The "Edit File name" menu item edits a file name of the currently loaded audio file.

- 1) **Select the "Edit file name" menu item and press the [ENTER/YES] key.**
The display now shows the "EDIT FILE NAME" screen. On this screen, you can edit the current file name (the leftmost character of the name flashes).

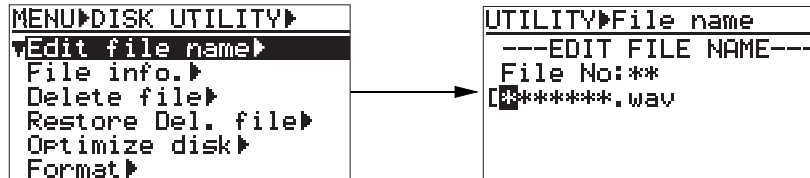

- 2) **Enter the desired name.**
Use the [SKIP/CURSOR |◀◀▶▶|] keys to move the cursor position and use the [MENU] dial (or the alphanumeric keys) to enter a desired character.

By pressing the [CLEAR] key repeatedly when the cursor is pointing the leftmost character, you can clear the whole name.

<Note>: ".wav", the file extension, is automatically added, therefore, you do not need to enter it.

- 3) **After entering the name, press the [ENTER/YES] key to confirm your setting.**
The unit exits the MENU mode and the display shows the Home screen.

<Note>: If you enter a file name which already exists and press the [ENTER/YES] key, "Illegal Name!" is shown and the display returns to show the previous screen before editing.

Viewing a file information and editing descriptor information [File info.]

Using the "File info." menu item, you can view audio file information, as well as edit the descriptor information. You can check the following file information.

- 1) File name of the audio file
- 2) Descriptor information (BWF Sound Sequence information)
- 3) File creation date (year/month/day)
- 4) File creation time (hour/minute/second)
- 5) LTC start time information (LTC time at the beginning of recording)
- 6) LTC end time information (LTC time at the end of recording)
- 7) Duration information (of audio area, shown in time code)
- 8) File occupying space

Viewing file information

- 1) Select the "File Info." menu item and press the [ENTER/YES] key.

The display changes to show the "Edit descriptor" screen, on which you can view the current file information.

You can view the descriptor information on the next level screen, while the other items are shown on this screen. You can scroll the screen by rotating the [MENU] dial.

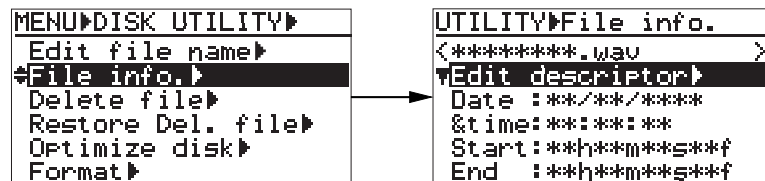

Viewing descriptor information

"Edit descriptor" is the Edit Sequence Descriptor function.

You can view and edit the recording area (up to 265 characters of the description area specified by the BWF standard) for the sound sequence information of a BWF file.

- 1) Select "Edit descriptor" and press the [ENTER/YES] key.

The display goes down to the next level screen of "Edit descriptor" and shows the BWF sound sequence information.

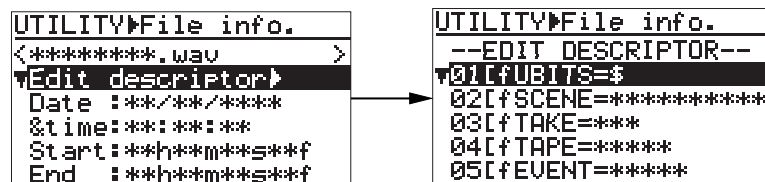

- 2) By rotating the [MENU] dial, the sound sequence information is scrolled. See the next page for details about the sound sequence information.

The sound sequence information of a BWF file includes items as below and you can edit them if necessary. "<New line>" at the bottom is used for adding a new descriptor information. See "Adding descriptor information" for details.

```

UTILITY>File info.
--EDIT DESCRIPTOR--
01[fUBITS=$
02[fSCENE=*****
03[fTAKE=***
04[fTAPE=*****
05[fEVENT=*****
06[fTRK1=*****
07[fTRK2=*****
08[fNOTE=
09[<New line>
    
```

The table below shows the details of the descriptor information which Fostex registers by default, as shown on the screen example above. The information can be used for creating an AVID ALE file, as well as can be directly exported to the AVID system via IEEE 1394 (or via a disk).

<Note>: Each character string before "=" shows the "header ID" of currently available meta data.

Line No.	Contents	Details
01	fUBITS=\$	The user bit used when recording time code is recorded by default.
02	fSCENE=*****	When creating a file, the character string before "-" in the file name is set as a SCENE by default.
03	fTAKE=***	When creating a file, the three-digit number between "-" and the file extension in the file name is set as a TAKE number by default.
04	fTAPE=*****	When creating a file, the reel number (volume label) on the disk is set as a TAPE number (up to 8 digits) by default.
05	fEVENT=*****	The five-digit number set by the "Set Next Event" menu item in the "System Setup" menu of the MENU mode is set as an EVENT number by default.
06	fTRK1=*****	Track name of each track. A default track name (up to 16 characters) for each track is recorded.
07	fTRK2=*****	The screen above shows the example when the recording mode is set to stereo (2-track). The number of lines increases when recording more tracks.
08	fNOTE=	This is used for comment. By default, no data exists.

Editing descriptor information

- 1) Use the [MENU] dial to select a desired descriptor information item and press the [ENTER/YES] key.
The first character of the selected descriptor information item flashes and you can now edit the item.

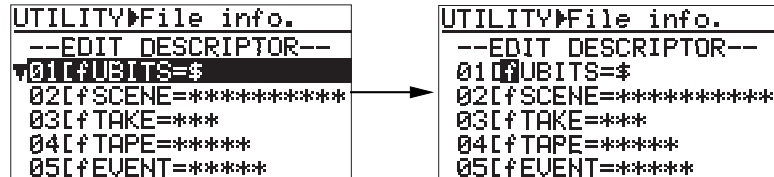

- 2) Use the [SKIP/CURSOR |◀◀ ▶▶|] key to move the cursor position to the right of "=" and make editing.
- 3) Use the [MENU] dial (or the alphanumeric keys) to enter characters.

While the cursor is on the first character of the descriptor information, pressing the [CLEAR] key repeatedly clears all the information.

- 4) After editing the information item, press the [ENTER/YES] key to confirm your setting.
- 5) To edit another descriptor information item, carry out the same procedure as above repeatedly.

Adding descriptor information

You can add a new descriptor information item to the current information.

- 1) Select "<New line>" at the bottom and press the [ENTER/YES] key.
You are now ready for entering a new item.
Carry out the same procedure as above for entering a new item.

<Note>: When adding a new descriptor information item, always enter the "meta data header ID", followed by data.

- 2) After entering new information, press the [ENTER/YES] key to confirm your setting.

Deleting descriptor information

Unused descriptor information can be deleted.

- 1) Select a line you want to delete, and press the [ENTER/YES] key.
You can now edit the line, as described above.
- 2) Press the [CLEAR] key repeatedly to clear the whole information, and press the [ENTER/YES] key.
The line is deleted, while the subsequent lines move up.

Deleting an unnecessary audio file [Delete file]

The [Delete file] menu item deletes an unnecessary audio file. You can delete only the currently loaded audio file, therefore, you must load the desired audio file before deleting it.

<Note>: A deleted file is not completely deleted from the disk. It still exists as a "hidden file". You can restore a hidden file by the "Restore Del File" menu item described later. However, if you optimize the disk after deleting a file, the file cannot be restored anymore.
A file completely deleted from a disk is shown as "<Deleted File>".

1) Select "Delete file" and press the [ENTER/YES] key.

The display goes down to the "DELETE FILE" screen, on which the current file number and file name are shown, while "Sure?" flashes.

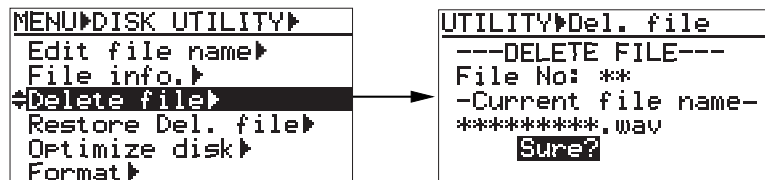

<Note>: To cancel deleting a file, press the [EXIT] key while "Sure?" is flashing.
You cannot cancel the operation after starting deleting.

2) Press the [ENTER/YES] again.

The unit starts deleting the current audio file. While executing deleting, "Please wait!" is flashing on the display.

When the delete operation is completed, "Completed!" appears on the display and the unit automatically exits the MENU mode.

Restoring a deleted audio file [Restore Del. file]

Using the "Restore Del. file" menu item, you can restore a hidden file which is deleted by the "Delete file" menu.

<Notes>

- If you optimize a DVD-RAM disk (or a hard disk partition), the deleted files cannot be restored anymore because the "hidden files" are completely deleted.
- A file deleted by computer operation cannot be restored.

1) Select "Restore Del. file" and press the [ENTER/YES] key.

The display goes down to the "RESTORE FILE" screen which shows the list of "hidden" audio files.

If no hidden file which can be restored exists, "No Deleted File!" is shown.

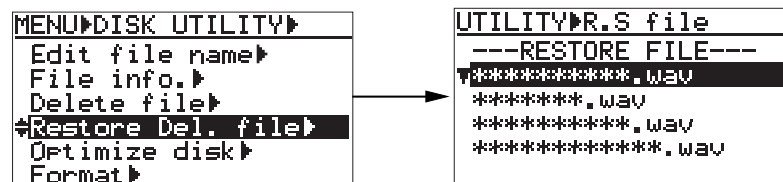

2) Select a file you want to restore using the [MENU] dial, and press the [ENTER/YES] key.

The unit restores the file.

After "Completed!" is shown, the display returns to the "DISK UTILITY" menu screen.

3) Press the [STOP/HOME] key to exit the MENU mode.

<Note>: The restored file has the same file number as when it was deleted.

Optimizing a disk [Optimize disk]

Using the "Optimize disk" menu item, you can optimize a current disk (a DVD-RAM disk or hard disk partition).

By optimizing a recorded disk (or partition), deleted (hidden) audio files are completely deleted, and the disk free space increases.

<Note>: If you optimize a DVD-RAM disk (or a hard disk partition), the deleted files cannot be restored anymore because the "hidden files" are completely deleted.

- 1) **Select "Optimize disk" and press the [ENTER/YES] key.**

The "CAUTION" screen appears, on which "Are you sure?" flashes.
To cancel optimizing the disk, press the [EXIT/NO] key.

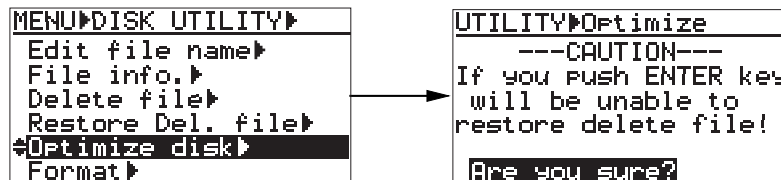

- 2) **Press the [ENTER/YES] again.**

The display now shows the "OPTIMIZING!" screen.

The disk (or partition) remaining space for completing is shown in "MB" as well as by the progress bar.

When optimizing completes, "Completed!" is shown.

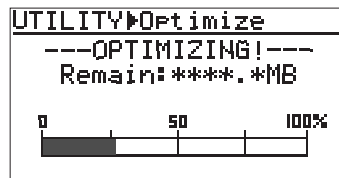

<Note>: The progress indication shows estimated information.
Do not carry out any operation until "Completed!" is shown.

- 3) **Press the [STOP/HOME] key to exit the MENU mode.**

Formatting a disk [Format]

Using the "Format" menu item, you can reformat a DVD-RAM disk or a partition of the optional hard disk drive in the UDF format.

For details about how to format an unformatted DVD-RAM disk, see "Initial format of a DVD-RAM disk" on page 20.

The following description assumes that a used DVD-RAM disk is set to the DVD-RAM drive.

- 1) **Select "Format" and press the [ENTER/YES] key.**

The display now shows "Format" screen.

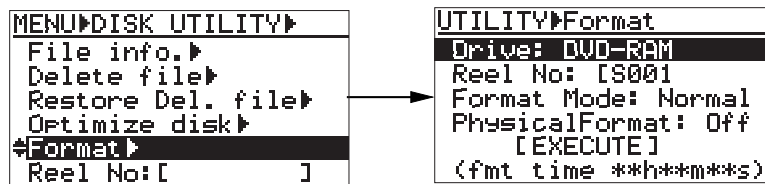

On this screen, you can make setting for the following items regarding formatting.

Drive	Selects a medium to be formatted. You can select from among "DVD-RAM" (a DVD-RAM set to the standard fitted DVD-RAM drive) and "PT01" through "PT08" (partitions of the optional hard disk drive). If the optional hard disk drive is not installed, "DVD-RAM" is the only option.
Reel No	Sets the reel number (volume label) of the selected medium. By default, the following numbers are set as the reel numbers. DVD-RAM: S001 PT01: S002, PT02: S003 PT08: S009
Format Mode	Selects the format mode between "Normal" and "DDR". If the optional hard disk drive is not installed, "Normal" is the only option. When the optional hard disk drive is installed and you are going to perform Dual Drive Recording to a hard disk partition and a DVD-RAM disk, select "DDR".
Physical Format	Selects whether physical-formatting the DVD-RAM disk (or a partition of the optional hard disk drive) or not. Only when "Format Mode" is set to "Normal", "Physical Format" setting is available. See page 147 for details.

- 2) **Make settings of the items above.**

Drive selection:

While "Drive" is highlighted on the "Format" screen, press the [ENTER/YES] key. The currently select drive (by default, "DVD-RAM") flashes and you can now select the desired option ("DVD-RAM" or "PT01" through "PT08") using the [MENU] dial. After selecting the option, press the [ENTER/YES] key to confirm your setting. "Reel No", the next item, is automatically highlighted.

<Note>: If the optional hard disk drive is not installed, "DVD-RAM" is the only option.

Volume label setting:

While "Reel No" is highlighted, press the [ENTER/YES] key. The first character of the current volume label (by default, "S") flashes and you can now enter the desired label using the [MENU] dial and alphanumeric keys. You can move the cursor position using the [SKIP/CURSOR] keys. Up to eight characters can be entered. After entering the desired label, press the [ENTER/YES] key to confirm your setting. "Format Mode", the next item, is automatically highlighted. You can also edit the volume label after formatting, using the "Reel No" menu item on the "DISK UTILITY" menu (see page 148).

<Note>: *If you enter an illegal volume label and press the [ENTER/YES] key to confirm, the display pops up "Illegal Name!" and the entered volume label is not accepted.*

Format mode selection:

While "Format Mode" is highlighted, press the [ENTER/YES] key. The current setting (by default, "Normal") flashes and you can now select the format mode between "Normal" and "DDR" using the [MENU] dial. After selecting the desired mode, press the [ENTER/YES] key to confirm your setting.

<Note>: *You cannot select "DDR", when the "Drive" item is set to "DVD-RAM".*

Normal	The medium selected by the "Drive" item (a DVD-RAM disk or hard disk partition) is formatted in the "Normal" mode. When setting the Format mode to "Normal", you can select On/Off of "Physical Format", the next item on the screen.
DDR	A hard disk partition selected by the "Drive" item, as well as a DVD-RAM disk set to the DVD-RAM drive, is formatted in the "DDR" mode. After executing formatting in this mode, the DVD-RAM disk is designated as a "mirror" disk for Dual Drive Recording. Dual Drive Recording records the same audio data to both the partition and DVD-RAM disk simultaneously. When formatting a partition in the "DDR" mode, you must set a DVD-RAM disk to the DVD-RAM drive. See "Dual Drive Recording" on page 86 in "Advanced operation" for details about "DDR" mode formatting.

<Note>: *When formatting a DVD-RAM disk in the "Normal" mode, the DV824 performs brief inspection of dirt, dust and defect on the medium even if "Physical Format" is set to "Off". However, note that the inspection cannot perfectly detect any dirt, dust and defects.*

<Note>: *It is recommended that you should format a partition and a DVD-RAM disk used for Dual Drive Recording in the "Normal" mode first, and then reformatting in the "DDR" mode.*

<Note>: *You cannot directly record only to a DVD-RAM disk which is set to the DVD-RAM drive when formatting a partition in the "DDR" mode, designated to the mirror disk of Dual Drive Recording. To make recording possible, reformat the disk in "Normal" mode.*

Physical format on/off setting

Only when selecting "Format Mode" to "Normal", you can select On or Off of the physical format.

While "Physical Format" is highlighted, press the [ENTER/YES] key. The current setting (by default, "Off") flashes and you can now select the option between "Off" and "On" using the [MENU] dial. After selecting the desired option, pressing the [ENTER/YES] key automatically highlight "[EXECUTE]".

On	A whole DVD-RAM disk (or a hard disk partition) is physically formatted. It takes long to execute physical format, however, we recommend physically formatting a well-used DVD-RAM disk (or a hard disk partition).
Off	A DVD-RAM disk (or a hard disk partition) is formatted in a simple manner. We recommend selecting this option for a relatively new DVD-RAM disk (or a hard disk partition). The DV824 also performs simple inspection of dirt, dust and defect on a DVD-RAM disk when formatting.

<Note>: We recommend executing physical formatting even a disk is relatively new if you have enough time.

<Note>: If the disk is not good condition, the unit may automatically execute physical formatting.

- 1) **While "[EXECUTE]" is highlighted, press the [ENTER/YES] key.**
The "CAUTION" message appears and "Are you sure?" flashes. To cancel formatting, press the [EXIT/NO] key.

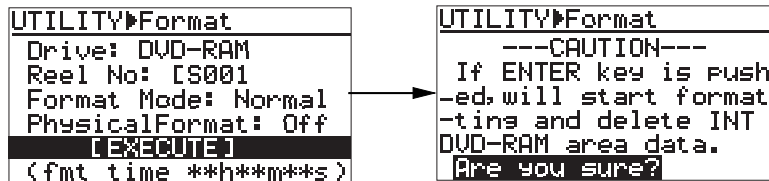

- 2) **Press the [ENTER/YES] key.**
The unit starts formatting the disk. The display shows the formatting progress. When formatting completes, the display shows "Fmt. Completed!".

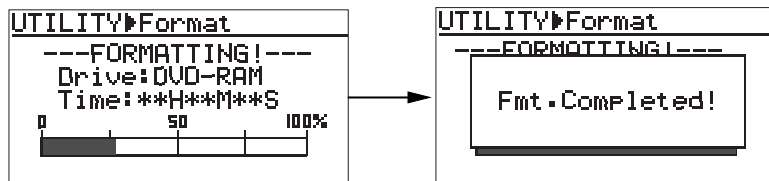

<Note>: The progress indication shows estimated information. Do not carry out any operation until "Fmt. Completed!" is shown.

- 3) **Press the [STOP/HOME] key to exit the MENU mode.**

Editing the reel number (Volume label) [Reel No.]

Using the "Reel No." menu item, you can edit the reel number of the currently selected disk (or partition). Note that the reel number set here is also reflected to the volume label.

The following procedure assumes that a disk (or partition) you want to edit the reel number of is loaded.

<Note>: If you edit the reel number (volume label) of the partition used for Dual Drive Recording, the edited result is also reflected to the DVD-RAM disk for Dual Drive Recording.

1. **Select the "Reel No." menu item and press the [ENTER/YES] key.**
The leftmost character of the current reel number flashes and you can now edit the reel number.

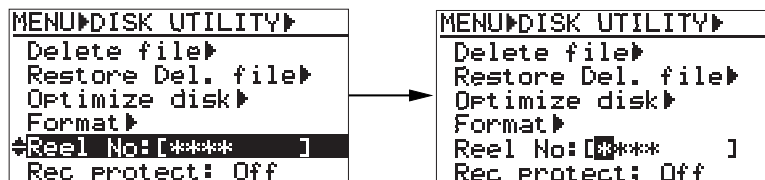

2. **Use the [MENU] dial or the alphanumeric keys to enter a desired reel number.**
Use the [SKIP/CURSOR] keys to move the cursor position.
When using the alphanumeric keys for entering characters, pressing any other alphanumeric key moves the cursor to the right automatically. You can enter up to eight characters for a reel number.
Pressing the [CLEAR] key clears the right next character to the cursor position.
3. **After editing the reel number, press the [ENTER/YES] key to confirm your setting.**
4. **Press the [STOP/HOME] key to exit the MENU mode.**

Record protection On/Off setting [Rec protect]

Using the "Rec protect" menu item, you can select "On" or "Off" of the protection (record inhibit) for the currently loaded audio file.

The following procedure assumes that an audio file you want to make protection setting is loaded.

<Note>: You cannot edit a protected audio file.

Select the "Rec protect" menu item and press the [ENTER/YES] key.

The current option ("On" or "Off") starts flashing (the default is "Off") and you can now select the desired option.

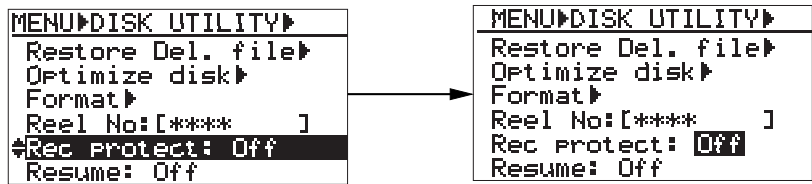

Use the [MENU] dial to select "On" or "Off", and press the [ENTER/YES] key to confirm your setting. Press the [STOP/HOME] key to exit the MENU mode.

<Note>: If you enter the UTILITY menu when no file is available on the current disk, "Rec protect:---" is shown instead of "Rec protect: Off (or On)". This means there is no audio file to which the "Rec protection" setting is applied. If you select it and press the [ENTER/YES] key in this case, "Void!" is shown.

<Note>: When a software-protected audio file is loaded, the "🔒" icon is shown in the status information area on the Home screen, as shown below. If the current DVD-RAM disk is hardware-protected, the "🔒" icon is shown beside the reel number area, as shown below.

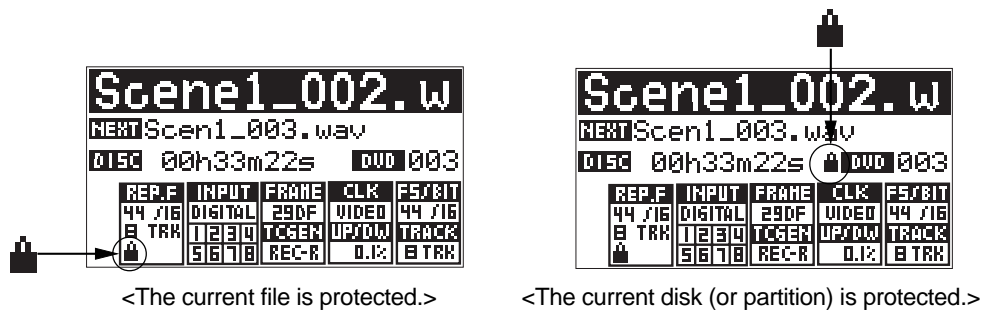

<Note>: The DV824 can protect each partition of the optional hard disk drive. See "Partition protection On/Off setting [Part. protect]" on the next page for details.

Resume function On/Off setting [Resume]

Using the "Resume" menu item, you can select "On" or "Off" of the resume function. By setting it to "On", the current audio file and its playback position is stored to the resume file when a DVD-RAM disk is ejected. Therefore, the unit automatically loads the same audio file at the same position next time you set the same disk to the unit.

Select the "Resume" menu item and press the [ENTER/YES] key. The current setting ("On" or "Off") starts flashing (the default is "Off") and you can now select the desired option.

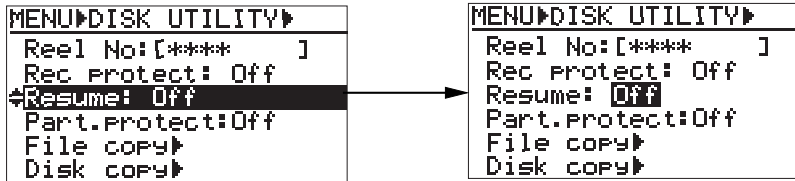

Use the [MENU] dial to select "On" or "Off", and press the [ENTER/YES] key to confirm your setting. Press the [STOP/HOME] key to exit the MENU mode.

Partition protection On/Off setting [Part. protect]

Using the "Part. protect" menu item, you can select "On" or "Off" of the software protection (record inhibit) for the current partition. The following procedure assumes that a partition you want to make protection setting is selected as the current drive.

Select the "Part. protect" menu item and press the [ENTER/YES] key. The current setting ("On" or "Off") starts flashing and you can now select the desired option (the default is "Off").

<Note>: If the optional hard disk drive is not installed or a partition is not selected as the current drive, "---" is shown.

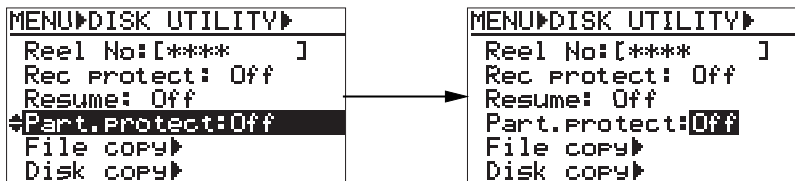

Use the [MENU] dial to select "On" or "Off", and press the [ENTER/YES] key to confirm your setting. Press the [STOP/HOME] key to exit the MENU mode.

<Note>: When a protected partition is loaded, the "🔒" icon is shown beside the partition number on the Home screen, as well as beside the partition name on the drive select screen (as shown below).

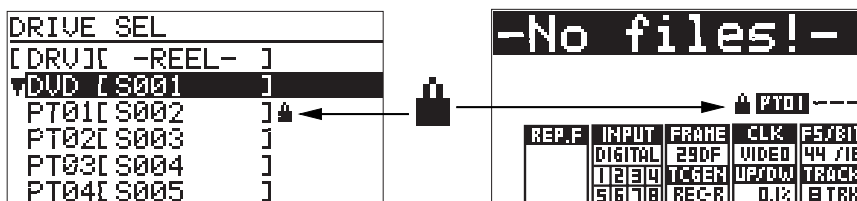

LOAD SETUP menu

Using the "LOAD SETUP" menu item, you can load setup data from among user setup data ("Box No0" through "Box No6") and default setup data.

A user setup data can be saved using the "SAVE SETUP" menu (described on next page).

- 1) **While the unit is stopped, press the [ENTER/YES] key.**

The unit enters the MENU mode and the MENU list screen is shown.

```

MENU▶
▶SYS SETUP▶
TC SETUP▶
DISK UTILITY▶
TCP/IP SETUP▶
RS422 SETUP▶
FILE SEL▶
  
```

- 2) **Use the [MENU] dial to highlight "LOAD SETUP" and press the [ENTER/YES] key.**

The display now shows the LOAD USER SETUP screen for selecting a desired user (or default) setup box.

```

MENU▶
FILE SEL▶
DRU/PAT SEL▶
CUE LIST▶
EDIT EDL FILE▶
▶LOAD SETUP▶
SAVE SETUP▶
  
```

→

```

MENU▶LoadUserSetup
--LOAD USER SETUP--
▶[Default setup]
Box No0[*****]
Box No1[*****]
Box No2[*****]
Box No3[*****]
  
```

<Note>: When loading "Default setup", all the menu items in the "SYS SETUP" menu are set to default. When loading any user setup box, they do not change.

- 3) **Use the [MENU] dial to select the desired box and press the [ENTER/YES] key.**

The data is immediately loaded. After "Completed!" is shown, the display returns to show the MENU list screen.

To exit the MENU mode, press the [STOP/HOME] key.

SAVE SETUP menu

Using the "SAVE SETUP" menu item, you can save the current data to a user box. The saved data can be loaded using the "LOAD SETUP" menu at any time.

<Note>: The default file names and track names, as well as event numbers, are not saved.

- 1) **While the unit is stopped, press the [ENTER/YES] key.**
The unit enters the MENU mode and the MENU list screen is shown.

```

MENU▶
▼SYS SETUP▶
TC SETUP▶
DISK UTILITY▶
TCP/IP SETUP▶
RS422 SETUP▶
FILE SEL▶
    
```

- 2) **Use the [MENU] dial to highlight "SAVE SETUP" and press the [ENTER/YES] key.**
The display now shows the SAVE USER SETUP screen for selecting a desired user setup box to which the current setting is saved.

<pre> MENU▶ FILE SEL▶ DRU/PAT SEL▶ CUE LIST▶ EDIT EDL FILE▶ LOAD SETUP▶ ▼SAVE SETUP▶ </pre>	→	<pre> MENU▶SaveUserSetup --SAVE USER SETUP-- ▼Box No0[-----] Box No1[-----] Box No2[-----] Box No3[-----] Box No4[-----] </pre>
---	---	---

- 3) **Use the [MENU] dial to select the desired box and press the [ENTER/YES] key.**
Now you can enter the user box name. The first character of the current box name (in the example below, "U" of "User0") flashes.

<pre> MENU▶SaveUserSetup --SAVE USER SETUP-- ▼Box No0[-----] Box No1[-----] Box No2[-----] Box No3[-----] Box No4[-----] </pre>	→	<pre> MENU▶SaveUserSetup --SAVE USER SETUP-- Box No0[U]ser0 Box No1[-----] Box No2[-----] Box No3[-----] Box No4[-----] </pre>
---	---	--

User box selection:

You can select between "Box No0" and "Box No6".

User box name entry:

You can enter up to eight ASCII characters.

You can clear the current name by pressing the [CLEAR] key repeatedly. You can enter a character at the cursor position using the [MENU] dial or alphanumeric keys.

- 4) **After entering a desired box name, press the [ENTER/YES] key to save data.**
The data is immediately saved. After "Completed!" is shown, the display returns to show the MENU list screen.
To exit the MENU mode, press the [STOP/HOME] key.

Chapter-9: Specifications

Inputs/Outputs

*0 dBu=0.775 Vrms, 0 dBV=1 Vrms.

Reference level : -12 dBFS/-18 dBFS/-20 dBFS (default: -20 dBFS, selectable in the "Ref. level" menu of the SYS SETUP menu)

ANALOG INPUT (CH1 through CH8)

- Connectors : XLR-3-31 type (balanced, pin 2: hot)
- Input impedance : More than 10k Ω
- Reference input level : +4dBu
- Maximum input level : +24 dBu

ANALOG OUTPUT (TR 1 through TR 8)

- Connectors : XLR-3-32 type (balanced, pin 2: hot)
- Output load impedance : More than 10k Ω
- Reference output level : +4 dBu
- Maximum output level : +24 dBu

PHONES

- Connector : 6mm dia stereo phone jack
- Applicable load impedance : More than 8 Ω
- Maximum output level : 100 mW (at 32 Ω)

DIGITAL I/O (for channels 1 through 8)

- Connector : D-sub 25-pin
- Format
 - <Input> : IEC 60958 (S/P DIF) or IEC 60958 (AES/EBU), auto selection
 - <Output> : IEC 60958 (S/P DIF) or IEC 60958 (AES/EBU), The format of an output signal is selected in the "Digital out" menu of the SYS SETUP menu.

WORD INPUT

- Connector : BNC type
 - Reference input level : TTL level (with 75 Ω termination switch)
- * The signal type (word or video) is automatically detected.

WORD OUTPUT

- Connector : BNC type
- Reference input level : TTL level

REMOTE

- Connector : MINI DIN 8pin (female)

P2/ES BUSS/INPUT

- Connector : D-sub 9-pin (female)
 - Protocol : Conformed to the Sony 9-pin protocol/ES BUSS
- * The controlled and controlling devices can be selected via RS-422 SETUP of the MENU mode.

P2/ES BUSS/THRU

- Connector : D-sub 9-pin (female)

ETHERNET

- Connector : RJ-45
 - * Conformed to IEEE802.3, 10BASE-T and 100BASE-TX standards.

USB (Keyboard Only)

- Connector : Series "A" Receptacle

DC IN

- Connector : XLR-4-32 type
- Input power requirement : 11~24V DC

Recording/playback

Recording Medium	: 5x DVD-RAM optional internal Hard disk drive.
Sampling Frequency/Quantization	: 22.05 / 44.1 / 48kHz 16bit : 44.1 / 48 / 88.2 / 96kHz 24bit
Recording Track	: 8
Track mode (Verify Write: ON)	: 1track 22.05/44.1/48/88.2/96kHz : 2track 22.05/44.1/48/88.2/96kHz : 4track 22.05/44.1/48/88.2/96kHz : 5track 22.05/44.1/48kHz : 6track 22.05/44.1/48kHz : 8track 22.05/44.1/48kHz
R/P Frequency Response	: 20 Hz to 20 kHz, +/-1 dB (fs 44.1kHz / 48kHz) : 20 Hz to 40 kHz +/-2 dB (fs 88.2kHz / 96kHz)
Signal to Noise Ratio	
Line (Input gain: +4dBu)	: 105dB (ADC-DAC, 24bit, ref. -20dBFS, fs: 48kHz) typical
Dynamic Range	: 105dB (ADC-DAC, 24bit, ref. -20dBFS, fs: 48kHz) typical
Reference Recording Level	: -12dB / -18dB / -20dB (selected the MENU mode)
T. H. D.	: Less than 0.006% (1kHz, -1dB, ADC-DAC, 24bit ref.-20dBFS, fs: 48kHz) typical
Cue Point Chunk	: 100

General

Dimensions	: 98.5 (H) x 482 (W) x 345 (D) mm
Weight	: Approx. 6.0kg
Power sources	: AC adaptor AD-15C, 11 ~ 24V DC
Power consumption	: Approx. 28 W, 12V 2.3A



* "DVD RAM" is a trademark of DVD format/Logo Licensing Corporation.

* Specifications and appearance are subject to change without notice for product improvement.

Physical dimensions

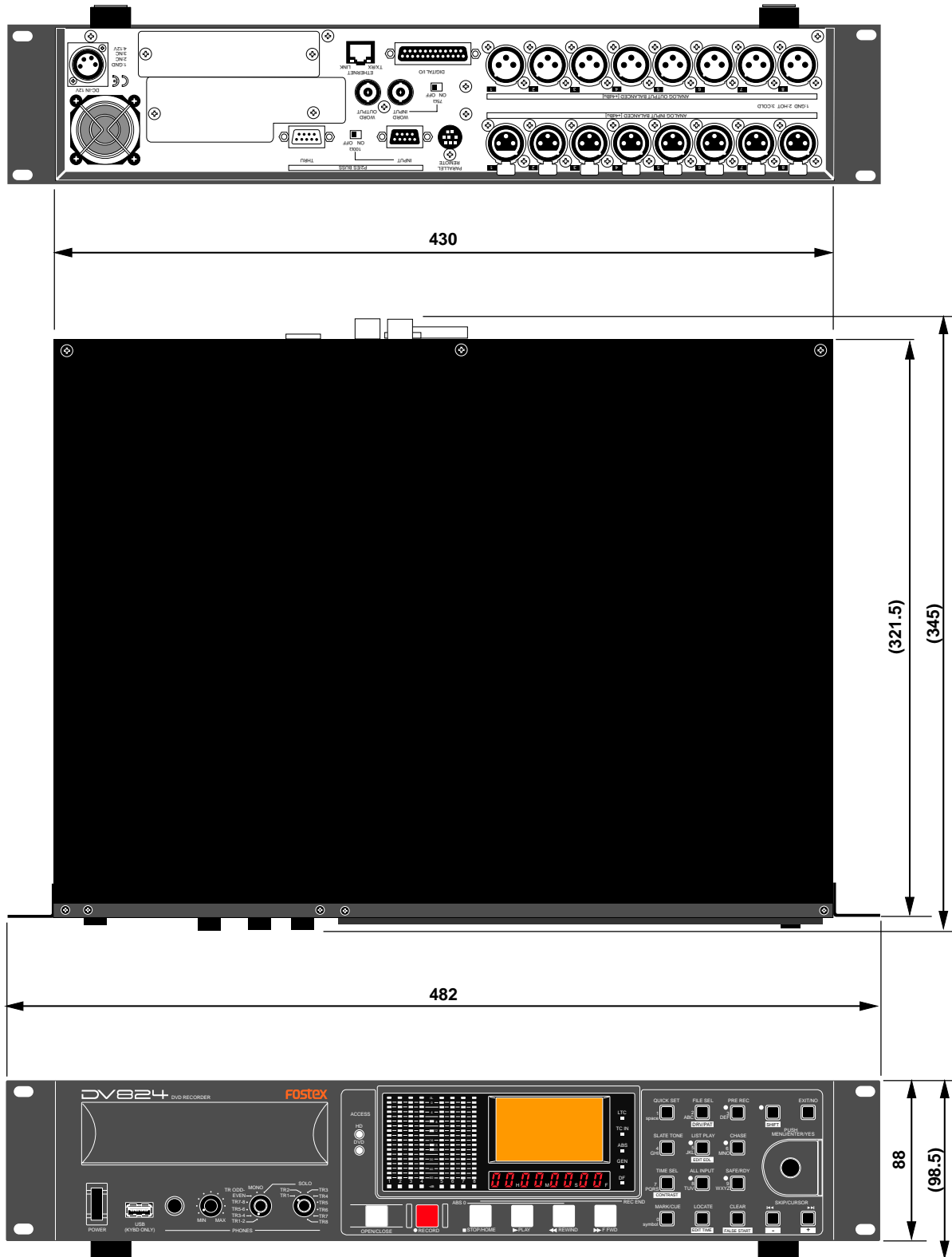

Declaration of EC Directive

This equipment is compatible with the EMC Directive (89/336/EEC) - Directive on approximation of member nation's ordinance concerning the electromagnetic compatibility and with the Low Voltage Directive (73/23/EEC) - Directive on approximation of member nation's ordinance concerning electric equipment designed to be used within the specified voltage range.

The Affect of Immunity on This Equipment

The affect of the European Specification EN61000-6-1 (coexistence of electromagnetic waves - common immunity specification) on this equipment are as shown below.

In the electrical fast transient/burst requirements, surge, conducted disturbances by radio-frequency fields, power frequency magnetic field, radiate electromagnetic field requirements and static electricity discharging environment, this could be affected by generation of noise in some cases.

FOSTEX DISTRIBUTORS LIST IN EUROPE

* Including non-EU countries (as of January, 2005)

<AUSTRIA>

NAME: ATEC Audio-u. Videogeraete VertriebsgesmbH.
ADD: Im Winkel 5, A-2325 Velm, Austria
TEL: (+43) 2234-74004, FAX: (+43) 2234-74074

<BELGIUM>

NAME: General Audio
ADD: Raymond Pelgrimslaan 101, B-1702 Groot-Bijgaarden, Belgium
TEL: (+32) 2-4630650, FAX: (+32) 2-4661500

<DENMARK>

NAME: SC Sound ApS
ADD: Malervej 2, DK-2630 Taastrup, Denmark
TEL: (+45) 4399-8877, FAX: (+45) 4399-8077

<FINLAND>

NAME: Noretron Oy Audio
ADD: P. O. Box 22, FIN-02631 Espoo, Finland
TEL: (+358) 9-5259330, FAX: (+358) 9-52593352

<FRANCE>

NAME: Sennheiser France
ADD: 128 bis, avenue Jean-Jaures, 94851 Ivry-sur-Seine Cedex, France
TEL: (+33) 1 4987 0300, FAX: (+33) 1 4987 0324

<GERMANY>

NAME: Mega Audio GmbH
ADD: Stromberger Str. 32, D-55411 Bingen, Germany
TEL: (+49) 6721-94330, FAX: (+49) 6721-32046

<GREECE>

NAME: Bon Studio S. A.
ADD: 6 Zaimi Street, Exarchia, 106.83 Athens, Greece
TEL: (+30) 210-3809-605, 606, 607, 608
FAX: (+30) 210-3845-755, 210-3827-868

<ICELAND>

NAME: I. D. elrf. electronic Ltd.
ADD: ARMULA 38 108 REYKJAVIK, ICELAND
TEL: (+354) 588 5010, FAX: (+354) 588 5011

<ITALY>

NAME: Proel S. p. A.
ADD: Zona Via Alla Ruenia, 37/43 64027 - Sant'Omero (Teramo), Italy
TEL: (+39) 0861-81241, FAX: (+39) 0861-887862

<THE NETHERLANDS>

NAME: IEMKE ROOS AUDIO B. V.
ADD: Kuiperbergweg 20, 1101 AG Amsterdam, The Netherlands
TEL: (+31) 20-697-2121, FAX: (+31) 20-697-4201

<NORWAY>

NAME: Siv. Ing. Benum AS
ADD: P.O. Box 145, Vinderen, 0319 Oslo, Norway
TEL: (+47) 2213 9900, FAX: (+47) 2214 8259

<PORTUGAL>

NAME: Caius - Tecnologias Audio e Musica, Lda.
ADD: Praca do Bom Sucesso, No 61 Bom Sucesso Trade Center, Escritorio 701/702, 4150 - 146 Porto, Portugal
TEL: (+351) 22-608-06-10, FAX: (+351) 22-608-06-29

<SPAIN>

NAME: Letusa S. A.
ADD: C/Laguna 10, 28923 Alcorcon, Madrid, Spain
TEL: (+34) 91-4862800, FAX: (+34) 91-6414597

<SWEDEN>

NAME: Sennheiser AB
ADD: John Ericssonsgaten 10, P.O. Box 22035, SE-104 22 Stockholm, Sweden
TEL: (+46) 8 566 16400, FAX: (+46) 8-8 566 16490

<SWITZERLAND>

NAME: Audio Bauer Pro AG
ADD: Bernerstrasse-Nord 182, CH-8064 Zurich, Switzerland
TEL: (+41) 1-4323230, FAX: (+41) 1-4326558

<UK>

NAME: SCV London
ADD: 40 Chigwell Lane, Oakwood Hill Industrial Estate, Loughton, Essex IG10 3NY U. K.
TEL: (+44) 20-8418-0778, FAX: (+44) 20-8418-0624

Fostex

FOSTEX CO.

3-2-35, Musashino, Akishima-shi, Tokyo, Japan 196-0021

FOSTEX AMERICA

15431, Blackburn Avenue, Norwalk, CA 90650, U. S. A.