

# Reference Manual

24 Track Digital Recorder

Model **D2424LVmkII**



## Introduction

Thank you for purchasing the Fostex D2424LVmkII.

The D2424LVmkII is a digital recorder using a 3.5 inch E-IDE hard disk recording media for recording/playback/editing in 24 real tracks plus 32 additional tracks.

In addition to non-compression recording at quantization 16 bit/44.1kHz or 48kHz, 24 bit/44.1kHz or 48kHz, 24 bit/88.2kHz or 96kHz, the D2424LVmkII is also equipped with adat input/output (by switching from S/P DIF).

Besides analog simultaneous record/playback, because it also complies with digital recording (S/P DIF or adat) using DATA input/output and simultaneous recording of analog input plus digital input (S/P DIF or adat), a full digital recording system can be built by combining the D2424LVmkII with various digital mixers.

Song data of the D2424LVmkII can be saved as an adat or S/P DIF digital signal, as well as can be backed up to the pre-installed CF drive as an FDMS-3 Ver. 3.0 or WAV file at high speed.

You can also use the optional E-IDE hard disk drive instead of the pre-installed CF drive for high speed backup of an FDMS-3 Ver. 3.0 or WAV file.

For optional units, Model 8346 TC/SYNC card is available and these will also comply to phasing of the standard feature WORD clock and also phasing against slave control by external LTC and VIDEO reference signals.

Please carefully read through this manual together with the separate "Quick Operation Guide" for long and satisfying operation of this equipment.

# Fostex®

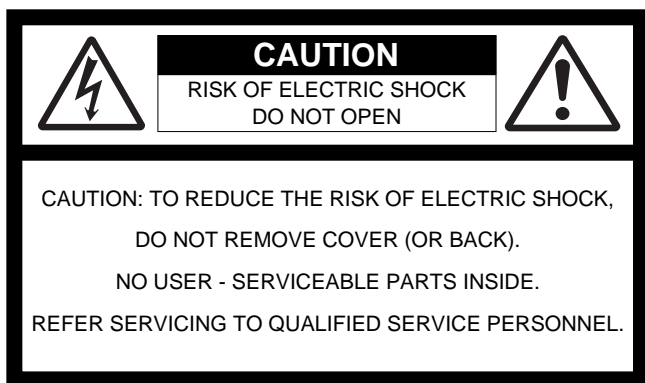

## "WARNING"

"TO REDUCE THE RISK OF FIRE OR ELECTRIC SHOCK, DO NOT EXPOSE THIS APPLIANCE TO RAIN OR MOISTURE."

## SAFETY INSTRUCTIONS

1. Read Instructions - All the safety and operating instructions should be read before the appliance is operated.
2. Retain Instructions - The safety and operating instructions should be retained for future reference.
3. Heed Warnings - All warnings on the appliance and in the operating instructions should be adhered to.
4. Follow Instructions - All operating and use instructions should be followed.
5. Water and Moisture - The appliance should not be used near water - for example, near a bathtub, washbowl, kitchen sink, laundry tub, in a wet basement, or near a swimming pool, and the like.
6. Carts and Stands - The appliance should be used only with a cart or stand that is recommended by the manufacturer.



An appliance and cart combination should be moved with care. Quick stops, excessive force, and uneven surfaces may cause the appliance and cart combination to overturn.

7. Wall or Ceiling Mounting - The appliance should be mounted to a wall or ceiling only as recommended by the manufacturer.
8. Ventilation - The appliance should be situated so that its location or position does not interfere with its proper ventilation. For example, the appliance should not be situated on a bed, sofa, rug, or similar surface that may block the ventilation openings; or, placed in a built-in installation, such as a bookcase or cabinet that may impede the flow of air through the ventilation openings.
9. Heat - The appliance should be situated away from heat sources such as radiators, heat registers, stoves, or other appliances (including amplifiers) that produce heat.
10. Power Sources - The appliance should be connected to a power supply only of the type described in the operating instructions or as marked on the appliance.
11. Grounding or Polarization - The precautions that should be taken so that the grounding or polarization means of an appliance is not defeated.

### CAUTION:

TO PREVENT ELECTRIC SHOCK, MATCH WIDE BLADE OF PLUG TO WIDE SLOT, FULLY INSERT.

### ATTENTION:

POUR ÉVITER LES CHOCS ÉLECTRIQUES, INTRODUIRE LA LAME LA PLUS LARGE DE LA FICHE DANS LA BORNE CORRESPONDANTE DE LA PRISE ET POUSSER JUSQU' AU FOND.



The lightning flash with arrowhead symbol, within an equilateral triangle, is intended to alert the user to the presence of uninsulated "dangerous voltage" within the product's enclosure that may be of sufficient magnitude to constitute a risk of electric shock to persons.



The exclamation point within an equilateral triangle is intended to alert the user to the presence of important operating and maintenance (servicing) instructions in the literature accompanying the appliance.

12. Power Cord Protection - Power supply cords should be routed so that they are not likely to be walked on or pinched by items placed upon or against them, paying particular attention to cords at plugs, convenience receptacles, and the point where they exit from the appliance.
13. Cleaning - The appliance should be cleaned only as recommended by the manufacturer.
14. Nonuse Periods - The power cord of the appliance should be unplugged from the outlet when left unused for a long period of time.
15. Object and Liquid Entry - Care should be taken so that objects do not fall and liquids are not spilled into the enclosure through openings.
16. Damage Requiring Service - The appliance should be serviced by qualified service personnel when:
  - A. The power supply cord or the plug has been damaged; or
  - B. Objects have fallen, or liquid has been spilled into the appliance; or
  - C. The appliance has been exposed to rain; or
  - D. The appliance does not appear to operate normally or exhibits a marked change in performance; or
  - E. The appliance has been dropped, or the enclosure damaged.
17. Servicing - The user should not attempt to service the appliance beyond that described in the operating instructions. All other servicing should be referred to qualified service personnel.
18. The appliance should be situated away from drops of water or spray of water.
19. Objects containing liquid such as vase must not be put on the appliance.
20. The appliance is not completely isolated from the power supply even if the power switch is at off position.
21. Apparatus shall not be exposed to dripping or splashing and no objects filled with liquids, such as vases, shall be placed on the apparatus.
22. Only use attachments/accessories specified by the manufacturer.
23. An appliance with a protective earth terminal should be connected to a mains outlet with a protective earth connection.
24. An appliance should be placed in a position where an AC plug / inlet can be easily pulled out by hand.
25. Main plug is used as the disconnection device. It shall remain readily operable and should not be obstructed during intended use. To be completely disconnected the apparatus from supply mains, the mains plug of the apparatus shall be disconnected from the mains socket outlet completely.

## Important Safety Instructions

- 1) Read these instructions.
- 2) Keep these instructions.
- 3) Heed all warnings.
- 4) Follow all instructions.
- 5) Do not use this apparatus near water.
- 6) Clean only with dry cloth.
- 7) Do not block any ventilation openings. Install in accordance with the manufacturer's instructions.
- 8) Do not install near any heat sources such as radiators, heat registers, stoves, or other apparatus (including amplifiers) that produce heat.
- 9) Do not defeat the safety purpose of the polarized or grounding-type plug. A polarized plug has two blades with one wider than the other. A grounding type plug has two blades and a third grounding prong. The wide blade or the third prong are provided for your safety. If the provided plug does not fit into your outlet, consult an electrician for replacement of the obsolete outlet.
- 10) Protect the power cord from being walked on or pinched particularly at plugs, convenience receptacles, and the point where they exit from the apparatus.
- 11) Only use attachments/accessories specified by the manufacturer.
- 12) Use only with the cart, stand, tripod, bracket, or table specified by the manufacturer, or sold with the apparatus. When a cart is used, use caution when moving the cart/apparatus combination to avoid injury from tip-over.
- 13) Unplug this apparatus during lightning storms or when unused for long periods of time.
- 14) Refer all servicing to qualified service personnel. Servicing is required when the apparatus has been damaged in any way, such as power-supply cord or plug is damaged, liquid has been spilled or objects have fallen into the apparatus, the apparatus has been exposed to rain or moisture, does not operate normally, or has been dropped.



# Contents

<b>Main features .....</b>	<b>8</b>
<b>Precautions .....</b>	<b>9</b>

## Names and Functions .....10

<b>Front panel section .....</b>	<b>11</b>
<b>Detachable controller section .....</b>	<b>12</b>
<b>Rear panel section .....</b>	<b>19</b>
<b>Display section .....</b>	<b>20</b>
Display shown when the power is turned on .....	20
Preset display .....	21
Switching the display using the [DISP SEL] key .....	22
Switching the time base display using the [SHIFT] key and [DISP SEL] key .....	22
Changing programs using the [PGM SEL] key .....	22
Warning display .....	23

## Before Starting .....25

<b>Time Base .....</b>	<b>25</b>
<b>Recording method and REMAIN indicator .....</b>	<b>26</b>
<b>Managing songs by program change function .....</b>	<b>27</b>
<b>Real tracks and Additional tracks .....</b>	<b>28</b>
<b>Input monitoring and playback monitoring .....</b>	<b>29</b>
<b>Audio file and event .....</b>	<b>30</b>

## Formatting and Optimizing disks .....32

<b>Formatting a current drive disk .....</b>	<b>32</b>
Formatting a brand new hard disk (Current drive) .....	33
Reformatting the current drive .....	34
<b>Formatting a backup disk (CompactFlash™ card or optional E-IDE hard disk drive) .....</b>	<b>35</b>
<b>Optimizing the disk .....</b>	<b>37</b>

## Handling Programs .....38

<b>Creating a new program .....</b>	<b>38</b>
<b>Duplicating a program .....</b>	<b>39</b>
<b>Using a program change function .....</b>	<b>40</b>
<b>Deleting a program .....</b>	<b>40</b>
<b>Editing a program title .....</b>	<b>41</b>
<b>Changing the program FS .....</b>	<b>42</b>

## Punch In/Out .....43

<b>What is Punch In/Out recording .....</b>	<b>43</b>
<b>Auto Punch In/Out .....</b>	<b>43</b>
Preparation .....	43
Rehearsing Auto Punch In/Out .....	44
Auto Punch In/Out Take .....	45
Single undo/redo auto punch in/out .....	45
<b>Manual Punch In/Out .....</b>	<b>46</b>
Preparation .....	46
Rehearsing Manual Punch In/Out .....	46
Manual Punch In/Out Take .....	47
Single undo/redo manual punch in/out .....	47

<b>Recording Digital data .....</b>	<b>48</b>
Digital recording from an external digital device .....	48
Digital recording to an external digital device .....	50
Connecting a Digital Mixer .....	51
<b>Recording to a Metronome Sound .....</b>	<b>52</b>
Preparation .....	52
Recording to a metronome sound .....	52
<b>Storing a Locate Point .....</b>	<b>54</b>
<b>Storing and editing the locate points to the memory keys .....</b>	<b>55</b>
Storing in real-time .....	55
Editing and stored data .....	55
<b>Storing and editing LOCATE key .....</b>	<b>56</b>
Storing in real-time .....	56
Edit and re-store data that is already stored .....	57
<b>Locate Function .....</b>	<b>58</b>
Direct Locate .....	58
Auto Play function .....	59
Auto Return function .....	59
Auto Repeat function .....	60
<b>Chain Play Function .....</b>	<b>61</b>
Setup of the Chain Play List .....	62
Setup of the Chain Play Mode .....	63
Specify the Program and Execute Chain Play .....	64
<b>Cue &amp; Review Function .....</b>	<b>65</b>
Cue & Review function using the [REWIND] and [F FWD] buttons .....	65
Cue & Review function using the Shuttle dial .....	65
Digital scrubbing using the envelope function .....	65
<b>Preview Function .....</b>	<b>67</b>
Executing the preview function .....	68
Trimming the sound while previewing .....	68
<b>Multiple Undo Function .....</b>	<b>69</b>
Using the Multiple Undo function .....	70
<b>Editing Tracks .....</b>	<b>71</b>
<b>Copy &amp; Paste and Move &amp; Paste .....</b>	<b>71</b>
Storing the edit point .....	72
Checking and adjusting the edit points .....	72
Executing Copy (or Move) .....	72
Checking the clipboard data .....	73
Executing Paste .....	73
Single undo/redo Paste .....	73
Copy & Paste between programs .....	74
Checking the clipboard data .....	74

<b>Erase</b> .....	<b>75</b>
Storing the edit points .....	75
Checking and adjusting the edit points .....	76
Executing Erase .....	76
Single undo/redo Erase .....	76
<b>Track Exchange</b> .....	<b>77</b>
Executing track exchange .....	77
<b>Registering the Track name</b> .....	<b>78</b>

## **MIDI Sync Function .....80**

<b>MIDI clock sync system</b> .....	<b>80</b>
Connecting external equipment .....	80
Setup of the D2424LVmkII .....	81
Confirming the MIDI clock sync .....	81
Execution of recording .....	82
<b>MTC sync/MIDI machine control system</b> .....	<b>82</b>
Connecting external equipment .....	83
Setup of external equipment .....	83
Setup of the D2424LVmkII .....	83
Confirming MTC sync/MMC .....	84
Execution of recording .....	84
<b>Multitrack system by the slave mode</b> .....	<b>85</b>
Equipment interconnections .....	85
Setup of the recorder (#1): <Master> .....	85
Setup of the recorder (#2) <Slave 1> and (#3): <Slave 2> .....	86
Check chase lock .....	87
Execution of recording .....	87
<b>External MIDI equipment sync system by the slave mode</b> .....	<b>88</b>
Connection to external equipment .....	88
Setup of external equipment .....	88
Setup of the D2424LVmkII .....	88
Confirming chase lock .....	89
Execution of recording .....	89

## **Saving and Loading Song Data .....90**

<b>About saved and loaded data</b> .....	<b>90</b>
<b>Saving the data using a adat or S/P DIF digital signal</b> .....	<b>92</b>
Connecting an external device .....	92
Setting up an external device .....	92
Executing the save operation .....	92
<b>Loading the data using a adat or S/P DIF digital signal</b> .....	<b>94</b>
Connecting the external device .....	94
Setting up an external device .....	94
Executing the load operation .....	94
<b>Saving and Loading using a CompactFlash™ card or optional E-IDE hard disk drive</b> .....	<b>96</b>
Saving in FDMS-3 Version 3.0 format .....	96
Loading an FDMS-3 file .....	97
Save function in FAT16 .....	98
Load function in FAT16 .....	100
Save function in FAT32 .....	101
About files to be saved .....	101
Saving a WAV file .....	102
Saving a DAT file .....	103
Load function in FAT32 .....	105
Loading a WAV file .....	105
Loading a DAT file .....	106

**Changing the Initial Setting (SETUP mode) .....108**

<b>Selecting SETUP menu</b> .....	<b>109</b>
<b>Time Signature Setting</b> .....	<b>110</b>
Storing a time signature .....	110
Modifying (or deleting) stored time signatures .....	110
Clearing all time signature and tempo settings .....	111
Changing the bar at ABS "0" of the time base .....	111
<b>Setting a Tempo</b> .....	<b>112</b>
Checking the stored tempo setting .....	112
Storing a tempo value .....	112
Modifying (or deleting) stored tempo settings .....	112
<b>Setting the Metronome function</b> .....	<b>113</b>
<b>Setting a preroll value</b> .....	<b>113</b>
<b>Setting MIDI sync output signal</b> .....	<b>114</b>
<b>Setting an MTC frame rate</b> .....	<b>114</b>
<b>Setting an MTC offset value</b> .....	<b>115</b>
<b>Setting Offset mode</b> .....	<b>115</b>
<b>Setting the Slave type</b> .....	<b>116</b>
<b>Setting the Record Protect function</b> .....	<b>117</b>
<b>Setting digital input</b> .....	<b>117</b>
<b>Setting digital output</b> .....	<b>118</b>
<b>Setting BAR/BEAT resolution mode</b> .....	<b>119</b>
<b>Setting the MIDI device number</b> .....	<b>120</b>
<b>Setting the Operating Clock</b> .....	<b>120</b>
<b>Checking the Number of Track Events</b> .....	<b>121</b>
<b>Setup of the Auto EE mode</b> .....	<b>122</b>
<b>Setup of the Foot switch function</b> .....	<b>122</b>
<b>Setup of the stop function at the mark point</b> .....	<b>123</b>
<b>Setup input/output Balance/Unbalance</b> .....	<b>123</b>
<b>Drive Format Information</b> .....	<b>124</b>
<b>Drive Setting</b> .....	<b>125</b>
<b>Setup of the display contrast level</b> .....	<b>126</b>
<b>Setup of 0 file recording function</b> .....	<b>126</b>
<b>Converting the additional track format</b> .....	<b>127</b>

**Others .....128**

<b>MIDI Implementation Chart</b> .....	<b>128</b>
<b>MMC Command List</b> .....	<b>129</b>
<b>Inquiry Message List</b> .....	<b>129</b>
<b>Fostex MIDI System Exclusive Message</b> .....	<b>130</b>
Status Request .....	131
Data Type .....	133
Explanation on the Command/Mode set .....	135
The Status Request/Command .....	137
Explanation on the Status Reply .....	138
<b>Maintenance</b> .....	<b>140</b>
<b>Specifications</b> .....	<b>140</b>

**APPENDIX (Operational manual for the recorder with the Model 8346 TC/SYNC card installed)**

## Main features

The unit's recorder section uses a recording format called FDMS-3 Ver 3.0 (Fostex Disk Management System-3). It uses an E-IDE hard disk as the recording media.

- A removable cartridge for easy installation and replacement of the hard disk at the front panel is employed.
- Equipped with 24-channel ANALOG inputs and outputs, which may be powerful for live recording, etc.
- By mounting the optional Model 9044 (Bay + Caddy) and installing the second E-IDE hard disk instead of the pre-installed CF drive, you can transfer data between two E-IDE hard disk drives.
- The recorder features non-destructive audio editing (a great advantage of digital recording) such as **Copy & Paste**, **Move & Paste**, **Erase**, etc. You can choose Time Base (ABS or MTC) or MIDI bar/beat/clock as the recorder.
- Complies to various sampling frequencies such as 44.1kHz 16bit/24bit, 48kHz 16bit/24bit, 88.2kHz/24bit and 96kHz/24bit. In addition, this recorder contain an "**FS converting function**" which makes it possible to change the sampling frequency of individual programs to meet application requirements.
- It contains the "**Track exchange function**" to allow exchanges between real tracks or between real track and the additional track.
- A "**Preview function**" allows for an intuitive fine-adjustment of an editing point (locate point).
- "**Single undo/redo**" for reprocessing record/edit mistakes and "**Multiple undo**" by time jump is possible (On/off can be set when formatting).
- A "**Vari Pitch function**" allows you to fine-tune the pitch.
- The "**Digital input setup function**", to allow digital recording of S/P DIF digital signals from CD/MD, and adat digital signals from adat equipment, are provided.
- A "**Digital output setup function**" is provided to digitally output, by selecting from the real track, any 2 output sources (S/P DIF) or 8 output sources (adat).
- Contains the "**Additional track format conversion**" function making it possible in "**V2 (56)**" <-> "**V1 (24)**" conversions.
- You can also use the DATA INPUT and OUTPUT connectors to an external DAT or adat, and to save and load song data (audio data and SETUP mode settings) to and from the DAT or adat.
- Save/load of **FDMS-3** or **WAV file** is possible by using the CompactFlash™ card or the optional E-IDE hard disk drive for backup.
- In addition to cueing by Jog/Shuttle dial, digital scrubbing using the envelope function is also possible.
- MIDI clock and Song Position Pointer can be transmitted according to the internal programmable Tempo Map. You can set up a synchronization system with a sequencer or a rhythm machine without wasting a track.
- You can use the recorder as a sync slave machine by sending MTC from a connected device.
- The recorder supports **MTC**, **MMC**, and **Fostex System Exclusive Message**, which allows for advanced control and high-precision synchronization from external sequencing software. You can set the device number and MTC frame rate for MMC and Fostex System Exclusive Message. Also, "**MTC Offset function**" and "**Offset Mode function**" are useful for setting up a sync environment using an external sequencing software.
- Auto Punch In/Out and Manual Punch In/Out functions offer two modes: "**Take**" for a real recording, and "**Rehearsal**" for monitoring the part between the in and out points.
- The "**Program Select function**" enables you to select a song from up to 99 songs and name the songs.
- A "**Bar/Beat Resolution function**" is used to edit audio at the beginning of the beat (round up or round off to a beat).
- The "**Metronome function**" can be used as a rhythm guide for recording.
- Various edit functions using an edit point (locate point), such as Copy & Paste, Move & Paste, Erase, Auto Punch In/Out, Auto Locate, are available. You can also locate ABS 0 or REC END regardless of the edit point (locate point).
- A maximum of **99 Locate Pointers** can be programmed for a LOCATE only feature. Simply select the LOCATE number desired for swift location.
- You can set a preroll time of **0 to 10 seconds**.
- A "**Disk Remain Display function**" offers a clear indication of available recording time and disk space (in mono track recording). You can choose the Time Base from ABS, MTC, and BAR/BEAT/CLK.



## Precautions

- Be sure to connect the recorder to the power supply specified in the Specifications section of this Reference Manual. Do not use an AC outlet of any other voltage.
- Do not connect the recorder to the same AC outlet to which devices that could generate noise (such as a large motor or dimmer), or the devices that consume a large amount of power (such as an air conditioning system or large electric heater) are connected.
- If you use the recorder in an area with a different power voltage, first consult your dealer or the nearest FOSTEX service station. You can use the recorder with a power frequency of 50Hz or 60Hz.
- It is very dangerous to use a power cord that is frayed or damaged. In such a case, stop using the recorder immediately and ask your dealer to repair the cord.
- To avoid possible electric shock and damage to the recorder, avoid contact with water or other liquids, or do not handle the power plug while your hands are wet.
- To prevent possible electric shock and damage to the recorder, do not remove the main unit cover or reach the inside the unit.
- Do not let water or other liquid, or metal objects such as pins, accidentally enter the inside of the recorder because this may lead to electric shock or damage. Should water enter the inside of the recorder, remove the power plug from the AC outlet, and consult your dealer or the nearest FOSTEX service station.
- To prevent damage to the recorder, be sure to power on the connected devices first, then turn on the power to the recorder.
- Before turning the power off to the recorder, first quit SETUP mode and make sure that the recorder section is stopped. Especially, never attempt to turn off the power to the recorder while the hard disk is accessing data (the HD ACCESS LED is lit or flashing). Otherwise, not only will you lose recorded data, but you may damage to the recorder. FOSTEX is not responsible for the data lost during operation of the recorder.
- Before you change the location of the recorder, pack the recorder in the shipping carton or an impact resistant case. Make sure that the recorder is kept free from external vibration or impact since the recorder is very sensitive to vibration.
- When you set a CompactFlash™ card to the CF drive, make sure to insert the card in the correct direction.  
If you attempt to insert the card in the wrong direction, the card or the drive may be damaged.

### Precautions on installation

- Do not install the recorder in locations subject to the following:
  - \* Extremely high or low temperature, or significant changes in temperature.
  - \* Excessive humidity or dust.
  - \* Excessive changes in power supply voltage.
  - \* Unstable or significantly vibrating or shaking surfaces.
  - \* Near a strong magnetic field (such as a TV or speaker).
- If you move the recorder from a place with an excessively low temperature to a warm place, or if you use the recorder in a room in which the temperature varies significantly during winter, condensation may occur on the hard disk or other parts. In such cases, leave the recorder for about an hour in the new location before you turn on the power.

### Note on repair

- This recorder does not use any parts that users can repair easily. Contact your dealer or the nearest FOSTEX service station to ask about repairs.
- Use the packing carton designed for the recorder when you transport the recorder to the dealer for repair or return.  
If you have discarded the packing box, try to pack the recorder completely using shock absorbing materials. Fostex is not responsible for malfunction or damage due to incomplete packaging or caused during transport.

### About copyrights

- It is prohibited by law to use any part of a CD recording or video images or audio data for which copyright is possessed by a third party for commercial purposes such as contents, broadcasts, sales, or distribution - any purpose other than for your personal pleasure.

### About damage

- FOSTEX is not responsible for any “direct damage” or “indirect damage” caused by using the recorder.

### Notes on replacing the internal lithium battery

- A lithium battery for operating the internal clock is contained inside the recorder.  
Under normal operating conditions, life of the lithium battery is about 3 years and it must be replaced after exceeding this period.  
As the lithium battery must be replaced by the Fostex Service Department, please contact our nearest service station.

# Names and Functions

Front panel-1



Front panel-2

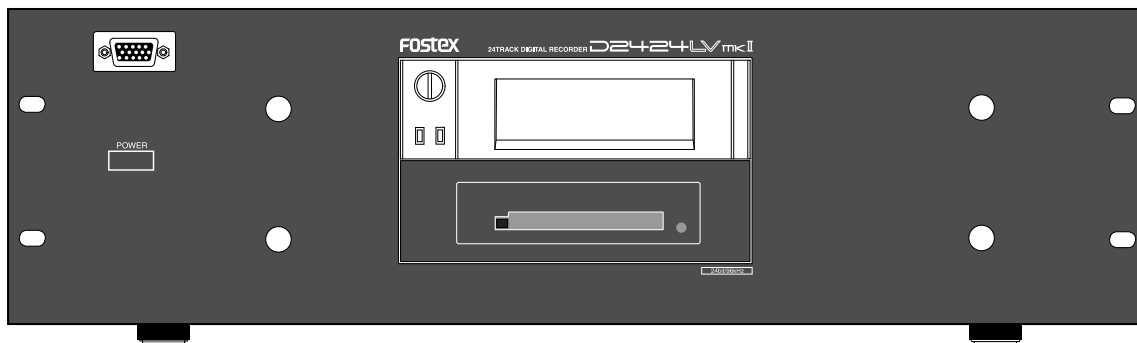

Rear panel

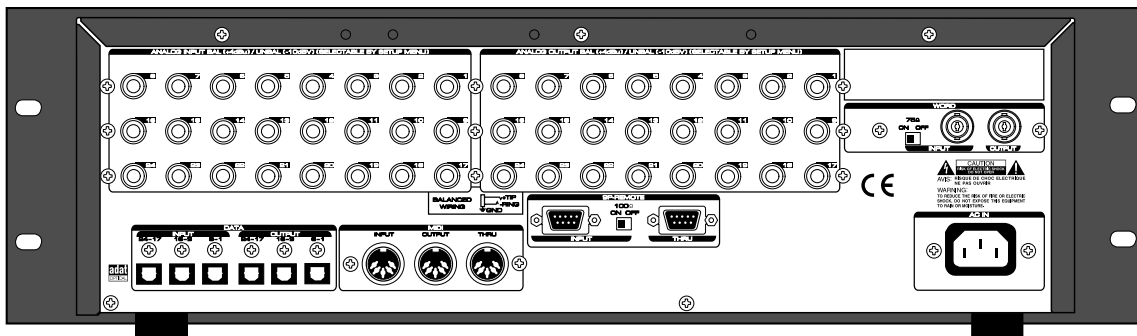

**Front Panel section**

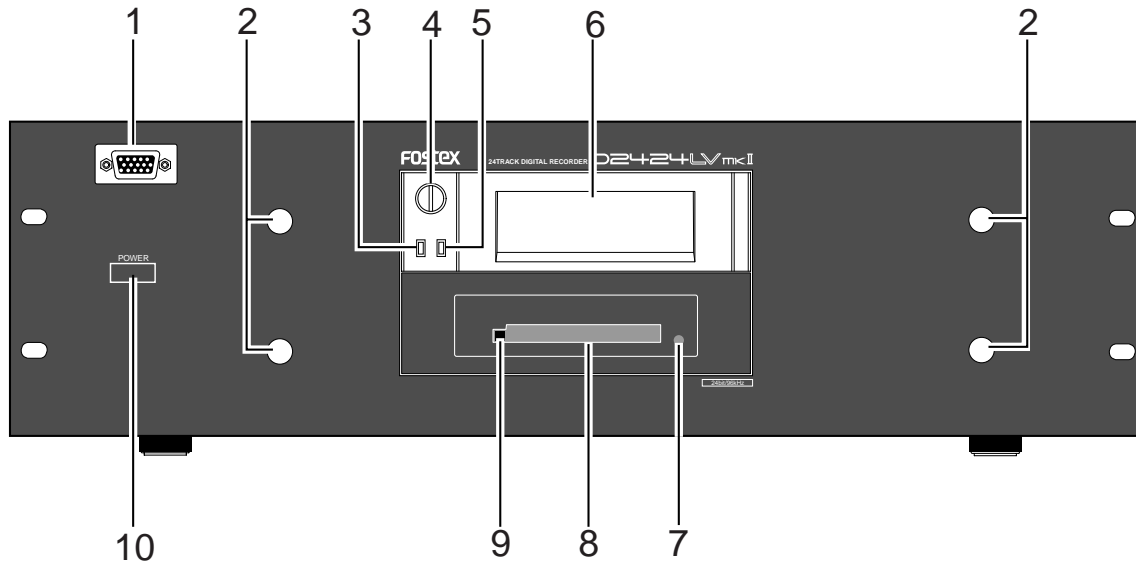

**1. Detachable remote controller connector**

The detachable remote controller is connected here. You can remove the controller. Connect the optional extension cable (Model 8551B) to extend the distance.

Consult the dealer you purchased the recorder from or out sales office about information on the extension cable.

**2. Controller mount**

The detachable remote controller is mounted on the front panel.

**3. Hard disk access LED (Red)**

This LED lights up or blinks when the hard disk is writing or reading data. (Same as the ACCESS LED on the detachable remote controller.)

**4. Lock/Unlock key**

When you remove or install the hard disk cartridge, you need to lock/unlock here using the included key.

**5. Hard disk power LED (Green)**

This LED lights up if the hard disk operates correctly when you turn the power on to the recorder.

**6. Removable hard disk cartridge slot**

This slot is used to insert a removable hard disk cartridge. This system allows you to replace the hard disk easily.

**<Note>:** The recorder package contains a caddy (without a hard disk). Install your hard disk in this caddy.

*\* Refer to "Quick operation Guide" for more information on how to replace the removable hard disk cartridge.*

**7. CF drive indicator**

Lights up when a CompactFlash™ card is correctly set to the CF drive.

**8. CF drive for backup**

You can set a CompactFlash™ card for data backup by the FDMS-3 or WAV file format. By installing the Model 9044 instead of the CF drive, you can use an E-IDE hard disk for backup. The replacement of the CF drive with the hard disk drive should be performed by an authorized person, so ask your local Fostex dealer or service station.

**9. Eject button**

Pressing this button ejects a CompactFlash™ card.

**<Note>:** Before you insert or remove a CompactFlash™ card, make sure that the unit is off. If you insert or remove a card while the unit is on, not only data may be lost, but also the card or drive may be damaged.

**10. Power switch**

This switch turns the main power to the recorder on/off.

**<WARNING !>:** Before turning the power off to the recorder, first quit the SETUP mode and make sure that the recorder section is stopped. Especially, never attempt to turn off the power to the recorder while the hard disk is accessing data (the ACCESS LED is lit or flashing). Otherwise, not only will you lose recorded data, you may damage to the unit.

**<Note>:** Should this power switch be switched On/Off in quick succession, in some cases it will fail to switch On at all. This is due to functioning of the internal protection circuit and is not a breakdown. Consequently, should such a symptom appear, switch Off power for a moment, then switch On again after waiting 1 or 2 minutes.

Detachable Controller section

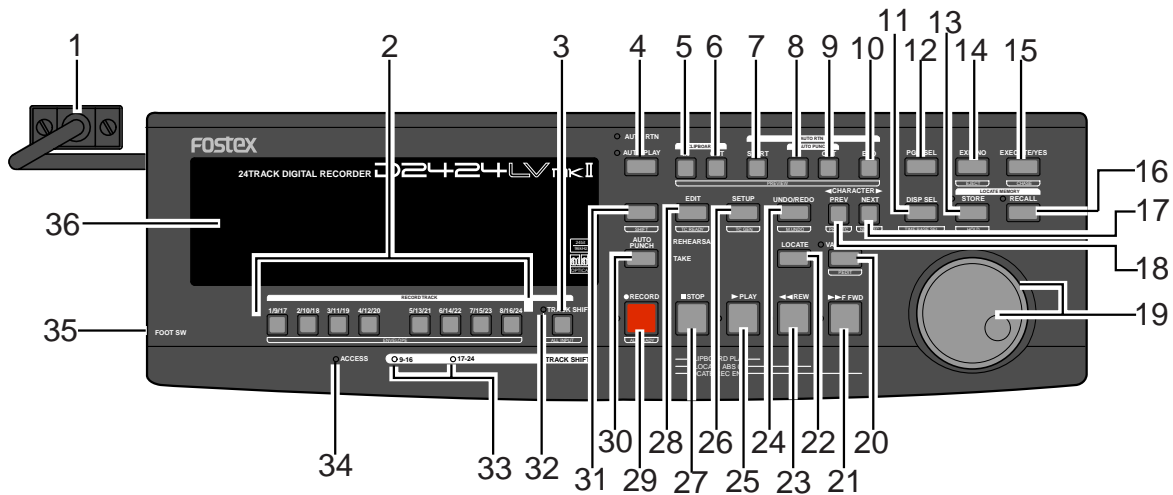

**1. Controller Connection Cable**

Connect this cable to the recorder controller connection jack.

**2. Record track select key [RECORD TRACK/ENVELOPE]**

"SAFE-READY" of the recording track can be selected (The track can be selected by shifting to 1-8, 9-16 or 17-24 with the [TRACK SHIFT] key.

If the select key is pressed once, that track will be in the READY state and the track display (□) will blink. It will change to SAFE if pressed again and the track display will be extinguished.

When recording is started from the READY mode, the blinking track display will light.

If the [RECORD] button only is pressed from the READY mode, the READY track only will enter input monitor mode, and the recording level can be adjusted. If the [RECORD] button is pressed once again, the D2424LVmkII will return to repro monitoring.

If any select key is pressed together with the [SHIFT] key, the envelope function of that track can be executed. This key is also used for editing such as copy paste, move paste and erase.

- \* Refer to page "29" for details about the reproduction monitor and the input monitor.
- \* Refer to page "65" for details about the envelope function.
- \* Refer to page "71" for details about the copy/paste and move/paste function.

**3. Track shift key [TRACK SHIFT/ALL INPUT]**

When selecting a recording track, this is pressed to shift to the selectable track. With each pressing of the key, the TRACK SHIFT LED will sequentially switch in order of:

"Extinguish" - "Lighting of 9-16" - "Lighting of 17-24" - "Extinguish" to indicate the modes listed below.

- \* All TRACK SHIFT LED extinguished: Tracks 1-8 can be selected.
- \* "9-16" are lighted: Tracks 9-16 can be selected.
- \* "17-24" are lighted: Tracks 17-24 can be selected.

All real track input monitors can be switch on or off each press of this key while pressing [SHIFT] key. When all tracks are set to input monitor, the ALL INPUT LED will light.

**4. Auto Play/Auto Return key [AUTO RTN/PLAY]**

Pressing this key repeatedly will change Auto Play mode, Auto Return mode, and Repeat mode On/Off as follows: (○ : LED off, ● : LED light up)

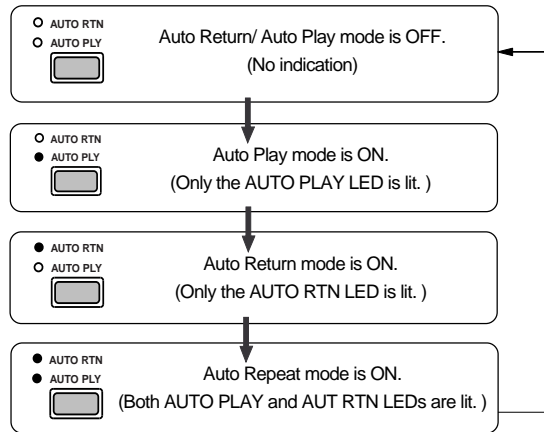

**Auto Play mode:**

In this mode, playback will start automatically after the START point is located. This function is effective at any locate points other than the REC END point.

**Auto Return mode:**

When the END point is reached during playback, the START point is automatically located in this mode. This function is effective only when the START and END points have been specified.

**<Note>**: The Auto Return function is works only during playback. In the recording mode, the START point will not be located automatically when the END point is reached.

**Auto Repeat mode:**

This mode is a combination of Auto Play and Auto Return, and plays back the part between the START and END points repeatedly. The auto repeat function is effective only when the START and END points have been specified correctly.

\* Refer to page “60” for details.

**5. Clipboard In key [CLIPBOARD IN/PREVIEW]**

This key is used to store and recall the In point (CLIPBOARD IN point) for the Copy or Move operation. You can locate a stored CLIPBOARD IN point. If you press the [CLIPBOARD IN] key while holding down the [SHIFT] key when the recorder is stopped, you can preview the fade-in part at the stored CLIPBOARD IN point.

\* Refer to page “71” for copying/moving data.  
 \* Refer to page “58” for locating the CLIPBOARD IN point.  
 \* Refer to page “67” for previewing data at the CLIPBOARD IN point.

**6. Clipboard Out key [CLIPBOARD OUT/PREVIEW]**

This key is used to store and recall the Out point (CLIPBOARD OUT point) for the Copy or Move operation. You can locate a stored CLIPBOARD OUT point. If you press the [CLIPBOARD OUT] key while holding down the [SHIFT] key when the recorder is stopped, you can preview the fade-out part at the stored CLIPBOARD OUT point.

\* Refer to page “58” for locating the CLIPBOARD OUT point.  
 \* Refer to page “71” for copying/moving data.  
 \* Refer to page “67” for previewing data at the CLIPBOARD OUT point.

**7. Auto Return Start key [AUTO RTN START/PREVIEW]**

This key is used to store and recall the start point (AUTO RTN START point) for the Auto Return or Auto Repeat operation. You can locate a stored AUTO RTN START point. If you press the [AUTO RTN START] key while holding down the [SHIFT] key when the recorder is stopped, you can preview the fade-in part at the stored AUTO RTN START point.

\* Refer to page “58” for locating the AUTO RTN START point.  
 \* Refer to page “71” for copying/moving data.  
 \* Refer to page “67” for previewing data at the AUTO RTN START point.

**8. Auto Punch In key [AUTO PUNCH IN/PREVIEW]**

This key is used to store and recall the recording start point (AUTO PUNCH IN point) for the Auto Punch IN/OUT operation. This point is also used as an erase point. You can locate a stored AUTO PUNCH IN point. If you press the [AUTO PUNCH IN] key while holding down the [SHIFT] key when the recorder is stopped, you can preview the fade-out part at the stored AUTO PUNCH IN point.

\* Refer to page “43” for more information about Auto Punch In/Out recording.  
 \* Refer to page “71” for more information about pasting data.  
 \* Refer to page “75” for more information about the Erase operations.  
 \* Refer to page “67” for previewing data at the AUTO PUNCH IN point.

**9. Auto Punch Out key [AUTO PUNCH OUT/PREVIEW]**

This key is used to store and recall the recording end point (AUTO PUNCH OUT point) for the Auto Punch IN/OUT operation. This point is also used as an erase point. You can locate a stored AUTO PUNCH OUT point. If you press the [AUTO PUNCH OUT] key while holding down the [SHIFT] key when the recorder is stopped, you can preview the fade-in part at the stored AUTO PUNCH OUT point.

\* Refer to page “43” for more information about Auto Punch In/Out recording.  
 \* Refer to page “75” for more information about the Erase operation.  
 \* Refer to page “67” for previewing data at the AUTO PUNCH OUT point.

Memory keys (CLIPBOARD IN, CLIPBOARD OUT, AUTO RTN START, AUTO PUNCH IN, AUTO PUNCH OUT, and AUTO RTN END keys) have the following common functions:

- Pressing a Memory key to recall the point the key is storing displays the memory data (time, or bar/beat/clock) currently stored in that key; then the recorder enters data edit mode. To edit data, use the Shuttle dial to move among the digits, and then use the Jog dial to change the value.
- After you finish editing data, press the [STORE] key, and then press one of the Memory keys into which you want to store the point. The edited data will be stored in the specified Memory key.
- While the current position of the recorder is indicated, press the [STORE] key, then one of the Memory keys into which you want to store the data. The current position or the recorder will be stored in the Memory key. You can do this while the recorder is running or stopped.
- Press a desired Memory key, and then press the [LOCATE] key to locate the point stored in that Memory key (time, or bar/beat/clock).
- In Setup mode, you can save or load song data for each Program.
- All data will be retained after you turn off the power.

\* Refer to page “54” for more information on memory data.  
 \* Refer to page “58” for more information on the Locate function.  
 \* Refer to pages “27” and “40” for more information on the Program Change function.  
 \* Refer to page “90” for more information on saving and loading song data.

**10. Auto Return End key [AUTO RTN END/PREVIEW]**

This key is used to store and recall the end point (AUTO RTN END point) for the Auto Return or Auto Repeat operation. You can locate a stored AUTO RTN END point. If you press the [AUTO RTN END] key while holding down the [SHIFT] key when the recorder is stopped, you can preview the fade-out part at the stored AUTO RTN END point.

\* Refer to page "58" for locating the AUTO RTN END point.  
 \* Refer to page "71" for copying/moving data.  
 \* Refer to page "67" for previewing data at the AUTO RTN END point.

**11. Display Select key [DISP SEL/TIME BASE SEL]**

This key is used to change the display mode. Pressing this key repeatedly will change the display mode as follows:

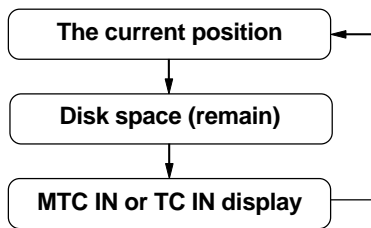

If an optional Model 8346 TC/SYNC card is installed, information in the MTC IN or TC IN will differ depending on "Ref. TC?" menu setting (MTC or LTC) in the SETUP mode. If the card is not installed, "00H 00M 00S 00F 00SF" will always be displayed.

\* Refer to page "26" in regards to REMAIN, page "108" on the SETUP menu, and the "APPENDIX" on details if the Model 8346 TC/SYNC card is installed.

Pressing this key while holding down the [SHIFT] key will switch the Time Base (\*) as follows. The Time Base can be set when the display shows the recorder's current position or the available disk space (REMAIN).

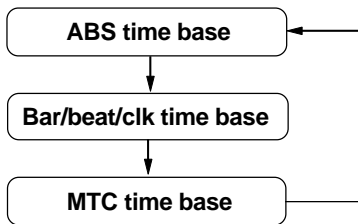

**(\*) Time Base:**

The recorder uses time display (ABS or MTC) or Bar/Beat/Clock display to indicate the current position of the recorder section. These displays are called "Time Base." ABS (Absolute Time) shows the absolute time of the disk, and MTC (MIDI Time code) shows the relative time obtained by adding an MTC offset value to the ABS value.

Bar/Beat/Clock (BAR/BEAT/CLK) indicates a position within a piece of music and conforms to the MIDI clock and Song Position Pointers created on the internal Tempo Map.

\* Refer to pages "25" and "108" for more information about MTC and the internal Tempo Map.

**12. Program select key [PGM SEL]**

This key has the following two functions depending on the setup condition of "Chain Play?" (Setup of the Chain Play Mode) in the SETUP mode.

**<When the "Chain Play?" menu is set to "Off">**

The D2424LVmkII will switch to setup of a new program and the program select execution mode when this key is pressed.

\* Refer to page "40" for program select function.

**<When the "Chain Play?" menu is set to other than "Off">**

You can specify the program at executing chain play when this key is pressed.

\* Refer to page "61" for details on the chain play mode.

**13. Store key [STORE/HOLD]**

This key is for storing time figures (or measure/beat/clock figure) in any memory key. Following this key, when each memory key is pressed, data shown in the display will be stored in their respective memory key.

Using "Press LOCATE: \*\*", which is shown after pressing the [RECALL] key, if this key is pressed after input of any number (00-99) in "\*\*," it is registered as time data for the specified locate number.

If this key is pressed while holding down on the [SHIFT] key, the currently shown time (BAR/BEAT/CLK) will be held and this data can then be edited. After editing, the time thus edited will be stored using the procedure above.

\* Refer to page "54" for registering in the memory key.

**14. Exit/No key [EXIT/NO/EJECT]**

The opposite of the [EXECUTE/YES] key, this key is used to stop operation.

**<Note>:** The "EJECT" function (the SHIFT function of the key) is reserved for future function and is not supported by this version.

**15. Execute/Yes key [EXECUTE/YES/CHASE]**

Press this key to execute the operation when you edit data on the hard disk using the edit functions such as Paste and Erase, when you put the recorder into SETUP mode, or when you set the parameters in the SETUP menu.

Pressing this key while holding down the [SHIFT] key allows you to select the Slave mode on/off.

\* Refer to page "71" for more information about using this key for the Paste or Erase operation.  
 \* Refer to page "108" for more information about using this key in SETUP mode.  
 \* Refer to page "85", "88" for more information about using this key for the Slave Mode operation.

## 16. Recall key [RECALL]

This is pressed to call out the time figure (or bar/beat/clk figure) data stored in locate number (0-99). If the [LOCATE] key is pressed after pressing this key, the RECALL LED will light and "Press LOCATE: \*\*" is displayed. Next, by pressing the [LOCATE] key after specifying a desired locate number, the time figure in memory will be recalled into the specified number and the recorder will enter the edit mode. Press the [LOCATE] key to execute this time figure.

\* Refer to page "58" for more information about using this key for the Locate operation.

## 17. Next key [NEXT/NEXT TC]

If this key is pressed when the recorder is in the PLAY/STOP/F FWD or REW mode, locate will be executed to the next memory point from the present location point.

When inputting characters in the title edit mode, it serves as a character short cut function.

The memory number can be advanced with each press of this key when the recorder displays "Press LOCATE: \*\*".

With an optional Model 8346 TC/SYNC card installed, if this key is pressed while pressing down the [SHIFT] key, the recorder will locate from the head of the currently recorded time code to the head of the next time code event.

## 18. Previous key [PREV/PREV TC]

If this key is pressed when the recorder is in the PLAY/STOP/F FWD or REW mode, locate will be executed to the one previous memory point.

When inputting character in the title edit mode, this serves as a character short cut function.

The memory number selecting during display of "Press LOCATE: \*\*", the memory number can be reverted with each press of this key.

With an optional Model 8346 TC/SYNC card installed, if this key is pressed while pressing down the [SHIFT] key, the recorder will locate from the currently recorded time code to the head of the previous time code event.

## 19. Jog/Shuttle dial

### Jog dial (inside):

Turning the Jog dial while the recorder is stopped performs digital scrubbing in either direction, which allows you to check the audio and locate a point without any change in pitch.

The Jog dial is also used to change values in the data edit mode or when the pitch data is displayed. It also allows you to select a parameter to set in Setup mode.

### Shuttle dial (outside):

FWD and REW direction shuttle operation in the STOP mode is possible at +/-1 ~ 64 times fast winding in the no sound state. On the other hand, FWD and REW direction shuttle operation in the PLAY mode is possible in the CUE playback mode at +1 ~ 8 and -1 ~ -7 times speed while cueing. In addition, while in the display edit mode, the editing point can be moved.

\* Refer to page "54" for more information about the editing the memory data.

\* Refer to page "108" for more information about SETUP mode.

\* Refer to page "65" for more information about Digital Scrubbing.

## 20. Vari-pitch key [VARI PITCH/P. EDIT]

Use this key to turn the Vari-pitch function on and off. When this function is enabled, the corresponding LED lights up. When this function is disabled, the LED turns off. The range of pitch variation for playback and recording is +/-6.0%, in 0.1% steps.

Press the [SHIFT] key, and then the [VARI PITCH] key to display the current pitch data.

To change the pitch data, use the Jog dial to change the value while the pitch data is displayed.

You can also change the playback speed when the data is being played back with the Vari-pitch function ON. To quit the pitch data display, press the [EXIT/NO] key, or the [STOP] button.

### <Notes>

\* Even if the pitch data is 0.0% (no speed change), pressing the [VARI PITCH] key will still turn on the VARI PITCH function. The speed is not changed, but the Vari Pitch is turned on.

\* The Vari Pitch function will automatically turn off under the following conditions:

1. You have turned off and on the power to this recorder. The pitch data will be reset to 0.0%.
2. You have pressed the [EXECUTE/YES] key while holding down the [SHIFT] key to turn the "SLAVE mode" on (the setting pitch data remains).
3. You set "Digital In" of the SETUP mode to a SYNC mode ("SPDIF :Sync" or "adat :Sync") and the recorder is locking to the external clock from DIGITAL IN or WORD IN. In consequence, "DIGITAL" and "EXT" indicators light in the display.
4. You have installed the optional Model 8346 TC/SYNC card in this recorder and set the LTC OUT to "Gen.".

\* Refer to "Quick Operation Guide" for more information on the Vari-pitch function.

\* Refer to pages "85" and "88" for more information on Slave mode.

## 21. Fast Forward button [F FWD]

Pressing this button while the recorder section is stopped will fast forward data at 30 times speed. Pressing this button in Play mode will cue data (you can hear sound during the fast forward operation) at five times speed.

Pressing this button while holding down the [STOP] button will initiate the "LOCATE ABS REC END" operation, and immediately locate the end of the recorded data on the Program (ABS REC END). (Refer to the "[STOP] button" section for more information about LOCATE ABS REC END.)

## 22. Locate key [LOCATE]

Use this key to start to start the LOCATE feature. Pressing this key after a memory key (CLIPBOARD IN/OUT, AUTO RTN START/END, AUTO PUNCH IN/OUT) locates the memory data programmed in each respective key (time mode or bar, beat, clock setting).

The data can be programmed by individually setting it with one of the 99 (01-99) LOCATE numbers of the [LOCATE] key.

Note that the data of memory number 00 is available in addition to LOCATE numbers 01-99.

The last LOCATE time setting (bar, beat, clock setting) constantly replaces the data stored in the [LOCATE] key as data in memory number 00.

Therefore, it is possible to press this key alone to repeatedly LOCATE the same point.

These data can be individually stored in programs P1-P99. The data for each program is SAVED or LOADED for each program when the song data is designated for SAVE/LOAD in the SETUP mode. This data is maintained even when the power is turned OFF.

*\* Refer to page "58" for more information about the Locate function.*

## 23. Rewind button [REWIND]

Pressing this button while the recorder section is stopped will rewind data at 30 times speed. Pressing this button in Play mode will cue data (you can hear sound while rewinding) at five times speed.

Pressing this button while holding down the [STOP] button will perform the "LOCATE ABS 0" operation, and immediately locate the beginning of the Program (ABS TIME: 00M: 00S: 00F). (Refer to the "[STOP] button" section for more information about LOCATE ABS 0.)

## 24. Undo/Redo key [UNDO/REDO/M. UNDO]

If you wish to restore the status prior to editing, recording, or performing a punch in/out take, press the [UNDO/REDO] key. Pressing the [UNDO/REDO] key again will return you to where you were before you pressed the [UNDO/REDO] key the first time.

If the current drive you are using has been formatted with the multiple undo function switched ON, you can execute multiple undo by pressing this key while holding down the [SHIFT] key.

**<Note>**: This key is enabled only when the recorder is stopped.

*\* Refer to pages "45", "47", "73" and "76" for more information about the single Undo/Redo operation.  
\* Refer to page "69" for more information about Multiple Undo function.*

## 25. Play button [PLAY]

Pressing this button will cause the recorder to play back. Pressing this button while holding down the [RECORD] button will start recording.

Pressing this button while holding down the [STOP] button will perform the Clipboard playback operation. Refer to the section "[STOP] button" for more information on the Clipboard playback.

Pressing the [PLAY] button during recording will stop recording.

## 26. Setup key [SETUP/TC GEN]

Press this key to puts the recorder in the SETUP mode to execute various operations. This key works when the recorder is stopped. To exit from the SETUP mode, either press the [EXIT/NO] key or the [STOP] button. If the optional Model 8346 TC/SYNC card is installed and external time code is being input, you can enter the generator setup mode by pressing this key while pressing on the [SHIFT] key.

*\* Refer to page "108" for more information on SETUP mode.*

*\* Refer to "APPENDIX" for more information about generator setup mode.*

## 27. Stop button [STOP]

Pressing this button will stop the transport section of the recorder. Pressing the PLAY, REWIND, or F FWD button while holding down this button will cause the recorder to perform the following operation:

[STOP] button + [PLAY] button
Clipboard playback (The STOP LED will flash and the PLAY LED will light up.) *1
[STOP] button + [REWIND] button
Locate ABS 0 *2
[STOP] button + [F FWD] button
Locate REC END *3

Pressing the [STOP] button will abort the editing operations and display the current position of the recorder, if you wish to:

- \* quit the data edit mode,
- \* cancel the recall or store operation,
- \* quit the pitch data display,
- \* cancel the edit operation, such as pasting, or
- \* cancel the SETUP menu settings.

Pressing the foot switch while holding down this button allows you to turn the punch in/out rehearsal mode ON/OFF.

### \*1 Clipboard playback:

The recorder plays back the copy data or move data for the Clipboard. During audio playback of the copy or move data, the FL will display the time length and data type ("Copy Clip Play!" or "Move Clip Play!"), and the copy or move source track indicator will flash, enabling you to quickly determine the track and data type.



**\*2 Locate ABS 0:**

The recorder will locate the top of the selected Program (ABS TIME: 00M: 00S: 00F).

**\*3 Locate REC END:**

The recorder will locate the end of the recorded data on the Program (ABS REC END).

These operations can be executed only on real tracks.

\* Refer to page "25" of the "Before Starting" section for more information about ABS 0 and ABS END.  
 \* Refer to page "46" for more information about Punch In/Out recording using the foot switch.  
 \* Refer to page "73" on details for "Clip board play."  
 \* Refer to page "58" on details for "LOCATE 0" and "LOCATE REC END."

**28. Edit key [EDIT/TC READY]**

Pressing this key enters the recorder to the menu select mode for editing tracks. Press this key repeatedly or turn the Jog dial to select menu. Edit menus appear in the following order. To execute a desired menu, select the menu, then press the [EXECUTE/YES] key. To exit the selection mode, press the [EXIT/NO] key.

If the optional Model 8346 TC/SYNC card is installed, you can enter the TC READY mode for recording time code by pressing this key while pressing on the [SHIFT] key.

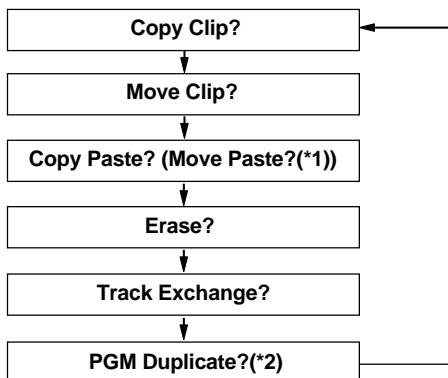

(\*1): After you execute copy clip, "Copy Paste" appears. After you execute move clip, "Move Paste" appears.

(\*2): The program duplicate display will appear only if the current drive was set to ON for the "Multiple Undo Function" when formatting. If the current drive is set to OFF, the program duplicate display will not appear even if the [EDIT] key is pressed.

\* Refer to page "71" for more information about "Copy Clip," "Move Clip," "Copy Paste," "Erase," and "Track Exchange."  
 \* Refer to page "39" for more information about program duplicate function.

**<Note>**: This key is enabled only when the recorder is stopped.

**29. Record button [RECORD]**

Pressing only this button places the readied tracks into input monitoring status. Pressing this button again will reset the tracks to playback monitoring. (The RECORD LED will blink when the readied tracks are in input monitoring status.)

Pressing the [PLAY] button while holding down this button will place the readied tracks into recording. At this time, the PLAY LED and RECORD LED will light, and the readied track indication will be light steadily (instead of blinking).

\* Refer to page "29" of the "Before Starting" section for more information about input monitoring and reproduce monitoring.

**30. Auto Punch Mode On/Off key [AUTO PUNCH]**

Switch this key ON for auto punch in/out. When you press this key while a correct value is stored to the [AUTO PUNCH IN] key and the [AUTO PUNCH OUT] key, both the REHEARSAL LED and TAKE LED will blink, indicating that Auto Punch mode is on. (If a correct value is not stored, pressing the [AUTO PUNCH] key will not turn the parameter ON, and the message "Void Out Point!" will appear.)

Pressing the [PLAY] button under this condition will put the recorder into "Rehearsal mode" for Auto Punch In/Out recording. Pressing the [PLAY] button and [RECORD] button simultaneously will put the recorder into "Take mode."

There are five combinations of the REHEARSAL LED and TAKE LED that indicate the status of the recorder regarding auto punch recording:

<b>Auto Punch mode OFF</b>	Both REHEARSAL LED and TAKE LED are off.
<b>Auto Punch mode ON</b>	Both REHEARSAL LED and TAKE LED are blinking.
<b>Auto Punch TAKE mode</b>	Only the TAKE LED (red) is lit.
<b>Auto Punch REHEARSAL mode</b>	Only the REHEARSAL LED (green) is lit.
<b>Rehearsal mode entered by means of MMC or foot switch</b>	Only the REHEARSAL LED (green) is blinking.

**<Note>**: If a correct value is not stored, pressing the [AUTO PUNCH] key will not enable the function, and the message "Void Out Point!" will appear. If a correct value is not stored, pressing the [AUTO PUNCH] key will not turn on the function, and the message "Void Out Point!" will alert you. In this case, set a correct value for the Auto Punch In/Out point. Also, the function is not turned on when you press the [AUTO PUNCH] key if the disk does not have enough recording space. The display will indicate "-\*\*H \*\*M \*\*S \*\*F Over."

\* Refer to page "43" for details about Punch In/Out operation.

### 31. Shift key [SHIFT]

Press a key, or button while holding down the [SHIFT] key to activate the following "shift-invoked" functions.

Key with SHIFT function	Function
[RECORD TRACK] select keys	Executes the envelope function of the selected track.
[TRACK SHIFT] key	Switches ON/OFF of the input monitor for all tracks.
[RECORD] button	Switches SAFE-READY for all tracks.
[CLIPBOARD IN/OUT] key	Executes preview of the stored point of each memory key.
[AUTO PUNCH IN/OUT] key	
[AUTO RTN START/END] key	
[EXIT/NO] key	Reserved for future function. Not supported by this version.
[EXECUTE/YES] key	Switches the slave mode ON/OFF.
[DISP SEL] key	Selects the time base.
[EDIT] key	Switches TC READY ON/OFF.
[SETUP] key	Enters the TC GEN setup mode.
[UNDO/REDO] key	Enters the multiple undo executing mode.
[VARI PITCH] key	Enters the vari pitch data editing mode.
[NEXT] key	The recorder will locate to the head of the next time code event, subsequent to the recorded time code. This functions only when an optional Model 8346 is installed.
[PREV] key	The recorder will locate to the head of the time code event previous to the recorded time code. This functions only when an optional Model 8346 is installed.
[STORE] key	Holds the current time data, which you can edit.

- \* Refer to page "108" for details on the SETUP mode.
- \* Refer to the "APPENDIX" at end of this manual in regards to the TC generator mode.
- \* Refer to page "69" for details on multiple undo function.
- \* Refer to the "Quick Operation Guide" in regards to editing of Vari Pitch data.
- \* Refer to page "67" for details on preview.
- \* Refer to page "65" for details on the envelope function.

### 32. All Input LED [ALL INPUT]

This is lit when all track input monitors are set to ON by pressing the [TRACK SHIFT] key while pressing the [SHIFT] key, and extinguished when set to OFF. While in the SETUP mode, it is also possible to automatically set it to all input monitors while the recorder is in the stop mode.

\* For details, refer to page 29 at end of this manual.

### 33. Track shift LED [9-16, 17-24] (green)

This is lit when the selectable recording track is shifted to 9-16 or 17-24.

### 34. Hard disk access LED (green)

This LED lights up or blinks when the hard disk is writing or reading data.

**<CAUTION>**: Do not turn the power off while this LED is lit or blinking. Otherwise, data on the hard disk may be damaged.

### 35. Foot switch jack [FOOT SW]

(Connector: PHONE jack)  
Punch in/out (also for rehearsal) or PLAY/STOP of the recorder can be done by foot by connecting the optional foot switch. The foot switch function can be changed in the SETUP mode. It will not function for punch in/out function in the initial setting.)

\* Refer to page "46" for information about Punch In/Out recording using the foot switch.

**<Note>**: Be sure to use an "unlatch type" foot switch if you use a foot switch. Otherwise, a malfunction could occur.

### 36. Meter display

This meter display shows the signal level and settings.

\* Refer to the "Display section" on page "19."

Rear panel section

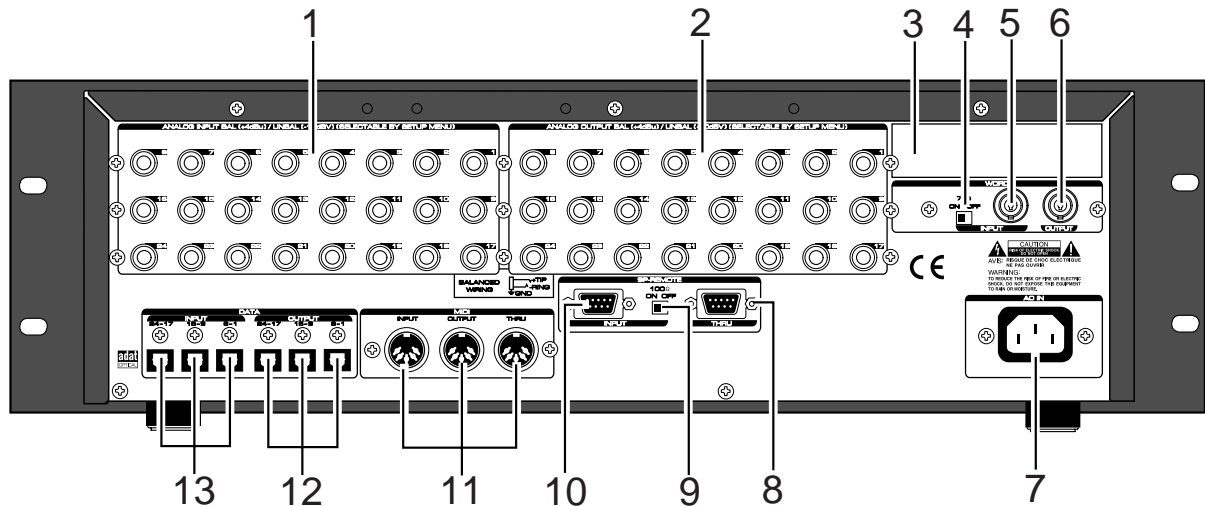

**1. Analog Input jacks 1~24 (Connector: PHONE)**

External analog audio signals to the D2424LVmkII are input here. These are connected, for example, to external mixer's group out (BUSS OUT) connectors.

**<Note>**: Analog input/output can be switched for balance (+4dBu)/unbalance (-10dBV) via the *SETUP* mode. At initial setup, it is set for unbalance (-10dBV).

**2. Analog Output jacks 1~24 (Connector: PHONE)**

Analog audio signals (Channels 1-24) from D2424LVmkII are output here. For example, this is connected to the external mixer [TAPE IN] connector.

**<Note>**: When using a current drive formatted to 96kHz 24 bits or 88.2kHz 24 bits, only [OUTPUT 1-8] will be functional.

**3. Optional Panel**

The additional installation panel for the optional Model 8346 (TC/SYNC card x1). Normally, it can be used with the panel remained installed.

**<Note>**: Installation of the option must be done by our Fostex Service Station. For details, please inquire at your nearest Fostex Service Station.

- For functions at installation of the optional Model 8346, please refer to "APPENDIX" on the last page of this manual.

**4. WORD IN terminating switch (75Ω)**

This is the [WORD IN] port terminating switch (75Ω). Turn this ON when inputting an external word clock signal into the [WORD IN] connector from digital equipment.

**5. WORD INPUT connector (Connector: BNC)**

Word clock signal from external digital equipment is input here for the purpose of phasing with external digital equipment.

**6. WORD OUTPUT connector (Connector: BNC)**

Word clock signal from the recorder is output to external digital equipment.

**7. AC IN connector**

The power cable packaged with this recorder is connected here.

**<Note>**: Always plug the power cable to the recorder before plugging the cable into the wall outlet.

**8. REMOTE THRU connector**

(Connector: D-sub 9-pin)

RS-422 control signal (SONY 9PIN PROTOCOL or Fostex System Exclusive Message) input from the [REMOTE INPUT] connector is output here.

This is connected to the second recorder REMOTE INPUT when controlling a multiple number of recorders.

**9. REMOTE INPUT terminating switch (100Ω)**

This REMOTE INPUT terminating switch (100Ω) is switched ON for normal use of an inputted RS-422 control signal into the [REMOTE INPUT] connector. When controlling a multiple number of recorders, the last one only is switched ON; the others are switched OFF.

**10. REMOTE INPUT connector**

(Connector: D-sub 9-pin)

External RS-422 control signal (SONY 9PIN PROTOCOL or Fostex System Exclusive Message) is input here to control this recorder.

## 11. MIDI Input/Output/Thru connector

(Connector: DIN 5-pin)

### MIDI INPUT:

Connect the [MIDI OUTPUT] connector of an external MIDI device here. The recorder can be controlled remotely via an external MMC (MIDI Machine Control) or FEX (Fostex System Exclusive Message).

### MIDI OUTPUT:

Connect the [MIDI INPUT] connector of the external MIDI device here. The recorder will output MTC (MIDI Time Code), MIDI Clock signal, MMC (MIDI Machine Control) response, and FEX (Fostex System Exclusive Message) response.

### MIDI THRU:

This connector outputs the input signal at the [MIDI INPUT] connector without modification. When using multiple recorders via MIDI, connect this terminal to the [MIDI INPUT] connector of the second recorder.

## 12. DATA OUTPUT connectors [1-8, 9-16, 17-24]

(Connector: OPTICAL)

Feed song data of the D2424LVmkII (sound data + various setup data) for saving data to an external digital device, as well as feed S/P DIF or adat digital signals to external digital equipment.

Depending on usage, the appropriate connectors should be used as follows.

\* Refer to page "90" for information about "LOAD" function.

\* Refer to page "48" for information "Recording Digital Data."

**<Note>**: The [DATA INPUT] and [DATA OUTPUT] connectors do not support 96kHz FS adat digital signals.

### <for song data>

[DATA OUTPUT] 1-8 must be used (the other connectors do not feed song data).

### <for S/P DIF digital signals>

[DATA OUTPUT] 1-8 feeds the signal for tracks 1-2.

[DATA OUTPUT] 9-16 feeds the signal for tracks 3-4.

[DATA OUTPUT] 17-24 feeds the signal for tracks 5-6.

### <for adat digital signals>

[DATA OUTPUT] 1-8 feeds the signal for tracks 1-8.

[DATA OUTPUT] 9-16 feeds the signal for tracks 9-16.

[DATA OUTPUT] 17-24 feeds the signal for tracks 17-24.

## 13. DATA INPUT connectors [1-8, 9-16, 17-24]

(Connector: OPTICAL)

These connectors receive song data (sound data + various setup data) from an external digital device, as well as receive S/P DIF or adat digital signals from external digital equipment (such as DAT recorder, MD recorder, CD player, adat equipment/digital mixer, etc.).

Depending on usage, the appropriate connectors should be used as follow.

### <for song data>

[DATA INPUT] 1-8 must be used (the other connectors do not receive song data).

### <for S/P DIF digital signals>

[DATA INPUT] 1-8 receives S/P DIF signal and routes to tracks 1-2.

[DATA INPUT] 9-16 and [DATA INPUT] 17-24 do not receive any signal.

### <for adat digital signals>

[DATA INPUT] 1-8 receives adat signals and routes to tracks 1 through 8.

[DATA INPUT] 9-16 receives adat signals and routes to tracks 9 through 16.

[DATA INPUT] 17-24 receives adat signals and routes to tracks 17 through 24.

## Display section

The recorder display integrates the level meter of a high-visibility FL tube with a 16 digits and 35 dot message display. The level meter shows the Track 1-24 output level of the recorder section. The time display shows the current time of the recorder section using ABS TIME (Absolute time), MTC (MIDI time code), or MIDI BAR/BEAT (bar/beat). This display also shows messages required for interactive operation. The following section explains the display functions and provides with some examples.

### 1. Display shown when the power is turned on

When you turn on the power to the recorder and the connected E-IDE hard disk (a formatted hard disk), the display shows the [Initializing...] message, [Current Dr], the name of the connected current drive, then recording mode (Standard format, etc.), and finally the top position of the disk in the time base (ABS, MTC, or BAR/BEAT/CLK) used in the last Program before you turned the power off.

The following example indicates that the recorder started with the ABS Time Base used in Program 1.

## 2. Preset Display

The display below shows all preset items for explanation purpose.

**Level meter**  
Displays recorder output level or recording level for each track.  
In the programs to 96 kHz 24 bits or 88.2 kHz 24 bits, only tracks 1-8 will function.

**35 dot message display**  
This display indicates the ABS time, MTC time value or bar/beat/clock value, and a parameter name in the SETUP mode.

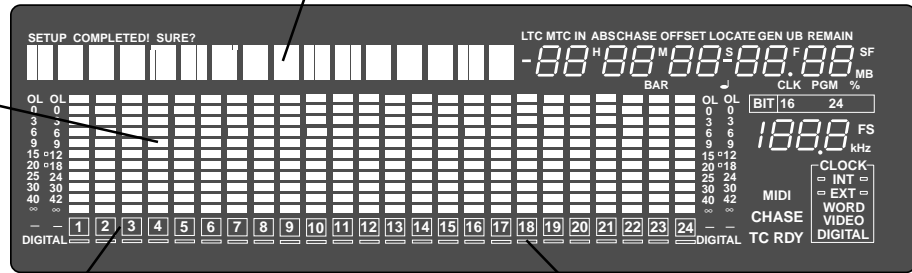

**Track indications**  
Each frame will blink when the track is READY, be extinguished in the SAFE mode and be lighted during recording. In the program to 96 kHz / 24 bits and 88.2kHz 24bits, only tracks 1-8 will function.

These will light when locked to digital in and "-" for the track set to digital-in will light up.

<b>ABS</b>	Lights up when ABS is selected as Time base.
<b>MTC</b>	Lights up when MTC is selected as Time Base.
<b>SIGNATURE</b>	Lights up to indicate a bar/beat/clock value when BAR/BEAT/CLK is selected as Time Base.
<b>LOCATE</b>	Lights up when the recorder enters data edit mode, enabling you to edit data. Pressing the LOCATE key while this indicate is lit will cause the recorder to locate the position of the displayed time or the bar/beat/clock value.
<b>REMAIN</b>	Lights up to indicate available recording time and space on the disk.
<b>MTC IN TC IN</b>	With the optional Model 8346 TC/SYNC card installed, this will be lit when MTC or LTC is externally input.
<b>MTC OFFSET</b>	Lights up when MTC OFFSET menu is selected in SETUP mode.
<b>CHASE</b>	Flashes when "Slave mode" is turned on. When a signal is locked, the flashing indicator lights up steadily.
<b>PGM</b>	Lights up to indicate the current program number.
<b>TEMPO</b>	Lights up when the tempo setting menu is selected in SETUP mode.
<b>BIT 16, 24 FS Hz</b>	Sampling frequency/quantization at formatting are displayed. This will also blink to warn that digital signals (S/P DIF or adat) of a wrong sampling frequency are being input.
<b>SURE?</b>	This message is shown to confirm whether or not you wish to execute a certain operation.

<b>MIDI</b>	This indication lights up when the recorder receives effective MIDI message from an external MIDI device.
<b>SAVE</b>	When the recorder enters save function mode, the selected parameter name will appear here.
<b>LOAD</b>	When the recorder enters load function mode, the selected parameter name will appear here.
<b>DIGITAL</b>	This lights when a digital input track is set and a digital signal is correctly input. It will blink if the digital signal is not correctly input.
<b>COMPLETED!</b>	This message indicates that an operation such as copy, move and paste has been completed.
<b>INT</b>	This lights up when the D2424LVmkII is operating using the internal clock.
<b>EXT</b>	This lights up when the D2424LVmkII is operating in sync with an external sync signal.
<b>WORD</b>	This lights up together with display of "EXT" when the D2424LVmkII is in sync with an external word signal.
<b>VIDEO</b>	This lights up together with display of "EXT" when the D2424LVmkII is in sync with an external video signal.
<b>&lt;Note&gt;</b> When D2424LVmkII is not in sync with external sync signals (word/video) and digital IN signals, "EXT", "WORD", "VIDEO" or "DIGITAL" display will blink. If this display is blinks, inspect the connectors and cables between external digital equipment and check that sync signals or digital signals from external equipment are correctly input.	
<b>TC RDY</b>	This blinks when the recorder is entered in the TC READY mode by pressing the [EDIT] key while holding down the [SHIFT] key, and will light during recording of TC.

### 3. Switching the display using the [DISP SEL] key.

Let's assume that you turned off the power while the time display was using a time base of "ABS," and then you turned the power on again. The recorder time display will again use a time base of "ABS."

**ABS TIME display**



At this time if you press the [DISP SEL] key, the Disk Remain display will appear. (Both recordable time and hard disk capacity remaining will be converted to mono track and expressed in time and megabytes.)

**DISK REMAIN display**



If "BAR/BEAT/CLK" is selected for the time base (explained later), the DISK REMAIN indication will show a value (in terms of the number of measures) calculated based on the last beat/tempo data on the tempo map of the recorded song.

If you press the [DISP SEL] key again, the MTC IN display will appear. If an optional Model 8346 TC/SYNC card is installed, and the reference TC is switched to "LTC", and an external TC is input, that reference input LTC time figure will be displayed.

**MTC IN display**

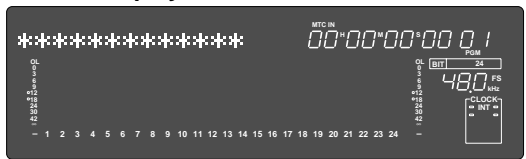

If you press the [DISP SEL] key again, the screen will return to the "ABS TIME" display.

### 4. Switching the Time Base display using the [SHIFT] key and [DISP SEL] key

When the screen is showing the ABS TIME or REMAIN display, if you press the [DISP SEL] key repeatedly while holding down the [SHIFT] key, the TIME BASE display will change cyclically. You can select one of the following Time Base displays.

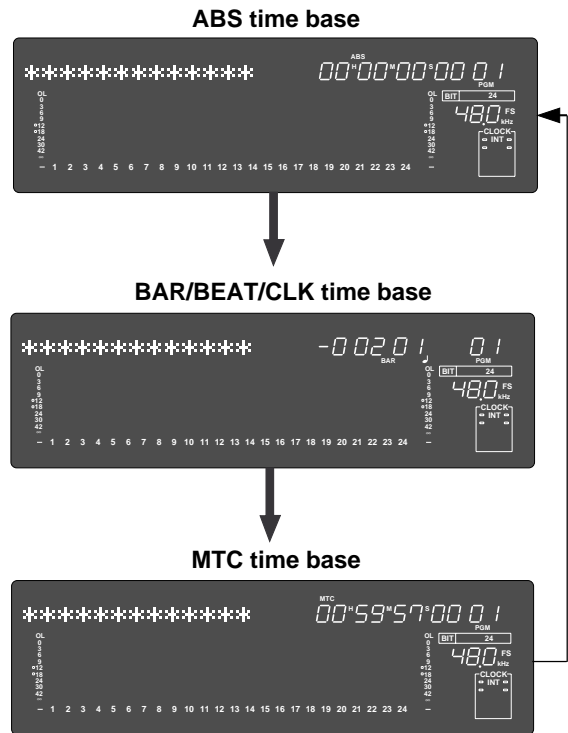

### 5. Changing Programs using the [PGM SEL] key

**<Note>:** Such operations as program compilation and selecting, will only functions when the "Chain Play?" menu in the SETUP mode is "Off." In regards to the "Chain Play?" menu in the SETUP mode, see page 61.

**\* About the Program Change function**  
The Program Change function divides the hard disk space into up to 99 parts to accommodate 99 separate Programs (P01-P99 - as long as available recording time allows) so you can record, play back, edit, and reachieve (save and load) data for each Program individually. For example, the first song can be Program 1, the second song can be Program 2, etc. You need to recall the desired Program before you start recording, playback, editing, or reachieving.

Pressing the [PGM SEL] key will cause the recorder to enter Program select mode, display the message "Select PGM!", followed by the current Program and Program number and a flashing "SURE?" indication.

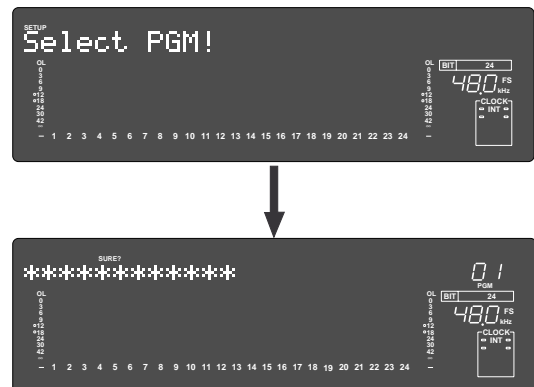

You can select the desired Program from the already setup Programs by rotating the Jog dial while the Program number and “SURE?” are flashing.

After you select a Program, press the [EXECUTE/YES] key to return to the selected Program’s ABS indication.

The Time Base display will indicate the selected Program’s Time Base, since you can set the Time Base for each Program individually.

To change the Time Base display after you have selected the desired Program, press the [DISP SEL] key while holding down the [SHIFT] key.

Pressing only the [DISP SEL] key will take you to the REMAIN display based on the current Time Base.

**<Notes>**

- The maximum record time of the program is dependent on the permissible record time (size) of the hard disk, regardless of how many programs are created on the disk. If, for example, there is roughly 30 minutes of record time remaining (REMAIN) on the current drive immediately after it is formatted, and a 20 minute program is recorded in Program 1, then there is only 10 minutes of recording time remaining for any additional programs. Simply put, if the total record time is 30 minutes it does not matter whether the 30 minutes is taken by 1 program or shared among several programs, since the total of 30 minutes for a recording remains the absolute total. Note that some disk space is compensated when several programs are created on the disk. A new program cannot be created when there is no recordable space remaining on the disk. However, programs produced by "Program duplicating" are exempted.
- For initial setup, when producing a new program, the initial setting of the currently active program is directly copied. For example, if there is a randomly set tempo map in the current program, that tempo map setting will be copied as the tempo map for the new program. This is convenient for producing a new program with the same setting as previously made music.

**6. Warning messages**

If you perform an incorrect operation, input incorrect data, or if an error occurs, the following alarm indication appears:

**• Invalid data indication:**

The input data is not appropriate for the operation.

**• Action to take:**

Input correct data.



**• Display of void:**

This is displayed if you attempt some sort of process for which the optional Model 8346 TC/SYNC card is necessary and is not installed.



**• Invalid In/Out indication:**

The In or Out point is not appropriate for the operation.

**• Action to take:**

Input correct data.



**• Overtime indication:**

Available disk space is insufficient for the length of time (the number of measures) indicated on the display.)



**• Action to take:**

During the copy & paste and move & paste operation, try to shorten the length of the copied data by the indicated amount. Alternatively, use the “ERASE” function to move the ABS END point backward to obtain enough disk space for editing.

**<Note>:** Optimizing the disk is necessary in the current drive in which multiple undo is ON.

**• Unassigned track indication:**

Select any track.



**• Action to take:**

Use the [RECORD TRACK] select key to ready any track.

• **Event overflow indication:**

The editing points have overflowed.



• **Action to take:**

After temporarily saving the data to the CompactFlash card via the SETUP mode "Save PGM?" menu, return the data to the recorder by the same SETUP mode "Load PGM?" menu. The editing number of points will be cleared and you can continue editing.

• **Load error indication:**

You cannot load data because the data input to the [DATA INPUT] connector contains an error.



• **Action to take:**

Check to see if there is an abnormality with the external digital machine connected to the [DATA INPUT] connector, or cable. Try to "LOAD" again.

• **Un-formatted indication:**

The internal hard disk is damaged or not formatted yet. After this message is shown for about 10 seconds, "Disk Format ?" in Setup mode will flash on the display.



• **Action to take:**

Press and hold down the [RECORD] button and press the [EXECUTE/YES] key to format the disk. (All audio and other data on the disk will be lost.)

• **Disk error indication:**

This disk cannot be read.



• **Action to take:**

Contact the Fostex service station as soon as possible.

• **Hard disk (E-IDE) connection error:**

The hard disk is not connected correctly.



• **Action to take:**

Correctly set the E-IDE hard disk again.

• **No disk error display:**

This is displayed when the removable disk is incorrectly set in the CompactFlash™ card.



• **Action to take:**

Reset the removable disk.

• **Recording Disable:**

Recording is disabled.



• **Action to take:**

Change the "Off" (recording) "Rec Protect ?" setting in Setup mode.



# Before Starting

This chapter describes some basic items that you need to know before you start operating the recorder. All users, including those who are familiar with using tape-based multitrackers and those who are new to multitrackers, should read this chapter thoroughly to understand the functions of the recorder.

1. Time Base
2. Recording method and REMAIN indicator
3. Managing songs by Program Change function
4. Real tracks and Additional tracks
5. Input monitoring and playback monitoring
6. Audio file and Event

## Time Base

The word “Time Base” appears frequently in this manual. The concept of Time Base is similar to a “tape counter” on a conventional tape-based multitracker in that it indicates the precise position of the recorder transport section (the current position).

The recorder offers three types of Time Base: ABS (Absolute type), MTC (MIDI time code), and BAR/BEAT/CLK (bar/beat/clock). ABS indicates an absolute time on the disk. MTC indicates a relative time that is obtained by adding a certain value (MTC offset value) to the ABS value. BAR/BEAT/CLK indicates the position in a song created in the internal Tempo Map according to MIDI clock and Song Position Pointer. The following diagrams depict the relationship among these three types of the Time Base.

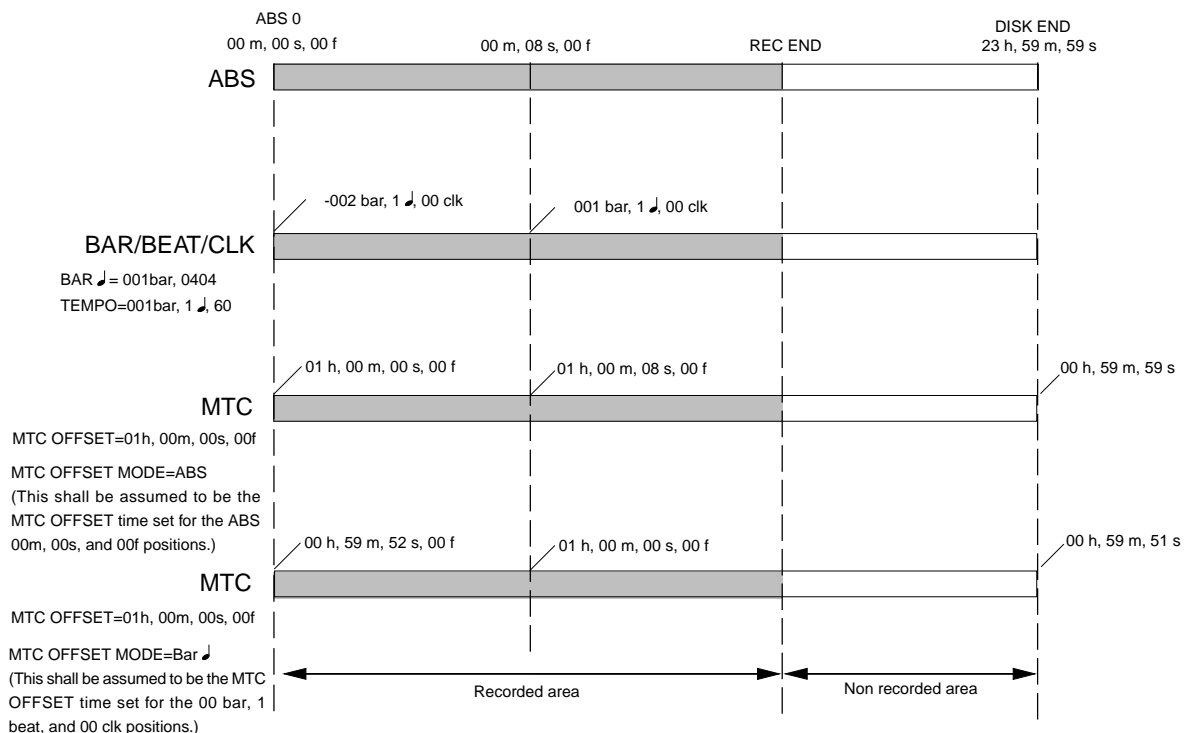

You can switch between these three types of Time Base to suit your purpose. (Refer to the explanation in “Display Section” on page “22” for more information on switching Time Base.)



**<Note>:** As shown in the figure, the ABS 0 position (top of the disk) is [-2 bar, 1 beat, 00 clk] (Time Base-BAR/BEAT/CLK). You can change this position in the ranged -9 bar to -2 bar in the “Setting the time signature” menu. Refer to the “Setting the time signature menu” section on page “108”.

## Recording method and REMAIN indicator

### Recording method

The recorder uses a E-IDE hard disk instead of a cassette tape. You can start recording sound sources from any point on a formatted disk as long as the point is within the range of 24 hours in ABS time, as described in the previous “Time Base” section. (Refer to the following diagram.)

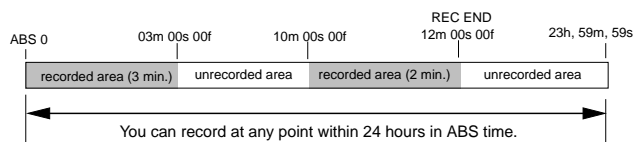

#### The area actually used on the disk.

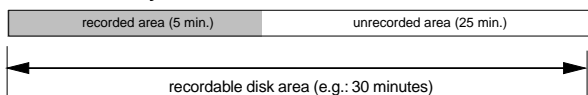

You can record at any point within 24 hours in ABS time.

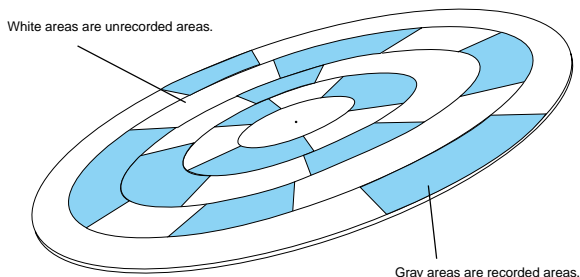

For example, if you record three minutes of data starting from ABS 0 (top of the disk) to ABS 03M 00S 00F on a disk that has a recordable space of thirty minutes, as shown in the diagram, then if you record two minutes starting at the 10-minute point in ABS time (ABS 10M 00S 00F) to ABS 12M 00S 00F, the recording end point (REC END) is 12 minutes (ABS 12M 00S 00F) in ABS time. However, this does not mean that the entire recording duration is 12 minutes. The disk space actually used for recording is five minutes (3 minutes + 2 minutes).

That is, the area between three minutes and ten minutes (that corresponds to 25 minutes of recording space) in terms of ABS time is still unrecorded.

When you try to play or fast forward this unrecorded area, the time counter on the display will count, but the recorder will not access the disk. However, MTC will be output when you try to play this area. On the recorder, the top of the disk is called “ABS 0” and the recording end point is called “REC END.”

### REMAIN indicator

The REMAIN indicator displays available recording time expressed in time value (ABS or MTC) or bar/beat/clock (BAR/BEAT/CLK) value, depending on the currently selected Time Base.

It also indicates the available disk space. Right after you format the disk, the REMAIN indicator will show the maximum recordable time and space on the disk.

The following example shows that the disk had about 3 hours recordable space after the disk format operation, and has recorded data of 2 hours 48 minutes 57 seconds.

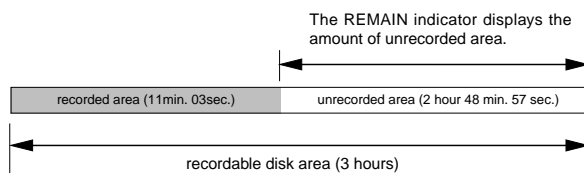

#### <Display example>



The REMAIN value is calculated on a mono-track basis. That value indicates the available recording time and space if you record on one mono-track. For example, if you wish to know how much you can record on eight tracks, you need to divide the current REMAIN value by eight.

The REMAIN value display is calculated from data on the real track and data on the additional track which will be explained later, and includes data left over for multiple undo. In other words, the REMAIN value will be displayed in the form of time/capacity obtained by deducting data on the real track, data moved onto the additional track and past editing data left over for multiple undo.

As described in “Managing the song by Program,” the recorder can set up as many as 99 Programs on the disk. Setting up a Program requires a small amount of disk space. In other words, disk space is used not only for storing recorded data but also for storing all setup data. Therefore, make sure that you have enough space on the disk before you start recording to avoid running out of space (the “OVER!” message flashes in that case).

## Managing songs by Program Change function

The recorder features a Program Select function, which enables you to set up to 99 Programs on the disk. When you format a disk, one Program is automatically created on the disk. You may create more Programs, if necessary. You may also delete unnecessary Programs.

The recorder also features Program Change function, which enables you to select one of the Programs set on the disk. Programs on the disk are something like independent containers. You can record, play, and edit each container without affecting other containers. You can also name Programs, which is useful for managing songs.

Additionally, as the sampling frequency can be changed individually for each program that is generated, programs with different FS can be contained in one current drive.

**NOTE:** The ability to change the FS is limited by the quantizing figure used at formatting.

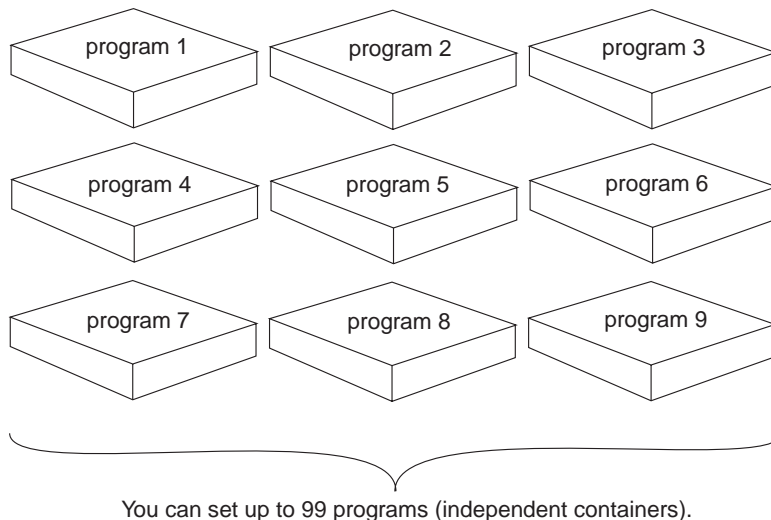

This is the Program indication when using an E-IDE hard disk as the current drive ([PGM] will appear before the program number such as [P01] shown in the example below).



- Refer to page “40” for more information on the program select function.
- Refer to page “39” for more information on the duplicating a program.
- Refer to page “40” for more information on the program delete function.
- Refer to page “41” for more information on the editing a program title.
- In regards to the "Chain Play?" menu in the SETUP mode, see page “61”.
- Refer to page “42” for “Changing the program FS.”

**<Notes>**

- Total available recording time is always the maximum available recording time on the disk, regardless of the number of Programs you set on the disk. That is, if you use up the maximum recording time for one Program, you will not be able to record any data in other Programs.
- As described in the “REMAIN indicator,” creating additional Programs will consume a small amount of disk space.
- Such operations as program compilation and selecting, functions only when the “Chain Play?” menu in the SETUP mode, is “Off.”



## Real tracks and Additional tracks

The D2424LVmkII contains, in addition to 24 real tracks that can be recorded/played back/edited in real time as one program, 32 additional tracks (In the current drive formatted at 96kHz/24bits or 88.2kHz/24 bits, it will be 8 real tracks + 48 additional tracks.).

Real tracks are normally used for real time recording of sound sources and the additional tracks serve the purpose of temporarily storing the sound recorded on the real tracks. In other words, by temporarily moving data recorded in the real track to an additional track, another performance can be recorded on the empty real track.

To exchange real tracks with additional tracks, the D2424LVmkII contains a "Track exchange function." By using this function, exchange is possible between all tracks, for mono tracks, stereo pair tracks (2 tracks) and in groups of 8 track units.

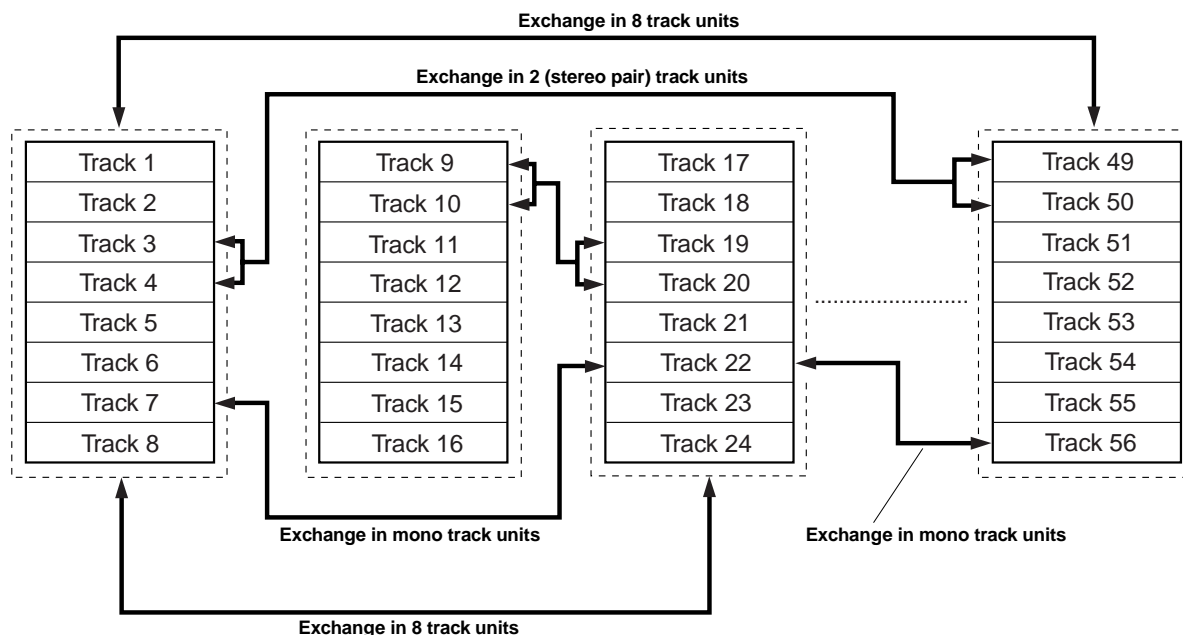

**<Notes>**

- You cannot record data on Additional tracks in real-time. Also, you cannot play back data on Additional tracks as is in real-time. If you wish to play back data on an Additional track, first use the Track Exchange function to move the data to a Real track. Also, you need to move the data to a Real track if you wish to check the REC END point of a song on an Additional track. Refer to page "77" for more information on the Track Exchange function.
- Data on the Additional tracks also affects the REMAIN value. If Real tracks contain no data, but Additional tracks contain data, the amount of data (time and space) will be reflected in the REMAIN value.
- If the record time of the data existing on the additional track is longer than the data on the real track and all tracks are saved on an external DAT or adat, then the data of the additional track can only be saved for the time equal to the real track, and the remaining data is not saved. This is because the ABS 0 to REC END of the real track is automatically recognized and saved. There is a need to exchange the track using the track exchange function in this case, as well. Refer to page "90" for more information on the SAVE/LOAD function.



**<Notes>**

- The "Format conversion of the additional track" menu is contained in the SETUP mode of this recorder. Using this menu, it is possible to convert or reverse convert, the additional track format of the current drive presently in use to the "V2 (56)" format (real track + additional track = 56).  
With this menu, the additional track format of the current drive presently in use can be converted or reverse converted from the "V2 (56)" format (real track + additional track = 56) to the "V1 (24)" format (real track + additional track = 24).  
What this menu is that hard disk compatibility is possible between the "V2 (56)" format D2424/D824mkII / D1624mkII and the "V1 (24)" format D824/D1624.  
In other words, a hard disk recorded in "V2 (56)" format equipment can be used in "V1 (24)" format equipment, or the reverse. However, care must be taken when converting the format. Refer to the SETUP mode in page "127" for details.
- Track composition of a D2424LVmkII formatted in 96kHz/24bit or 88.2kHz/24bit will be 8 Real Tracks + 48 Additional Tracks.



## Input monitoring and playback monitoring

There are two methods for monitoring track sound (only on the Real tracks): input monitoring and playback monitoring. They are defined as follows:

### Input monitoring

Input monitoring means to listen to what is being input to the recorder so that you can verify sound quality and etc. Either one of the following procedure is used to input monitor any Real Track or all Real Tracks.

• **Entering any Real Track to input monitoring**

To enter any desired track for Input Monitoring, press the desired **[RECORD TRACK]** select key to enter it in the READY mode and then press the **[RECORD]** button. If the **[RECORD]** button is pressed again, the recorder will enter the repro mode. The recorder will enter record standby mode and the READY track only will be Input Monitoring.

The recording level can now be adjusted.

• **Entering all Real Tracks to input monitoring**

To enter all Real Tracks to input monitoring, press the **[TRACK SHIFT]** key while holding down the **[SHIFT]** key.

Unlike the previous case of selecting any desired track, Real Tracks can all be input monitored even though the **[RECORD]** button is not pressed. After adjusting the recording level, to simultaneously start recording all tracks, enter all tracks in the READY mode by pressing the **[RECORD]** button while holding down the **[SHIFT]** key.

• **Entering a track set to Input Monitoring to "recording mode"**

To enter the recording mode with any desired track or all tracks in the READY state, press the PLAY button while holding down the **[RECORD]** button.

READY tracks will enter the recording mode, the READY track LED change to constant light and the RECORD LED will be lit.

Simultaneous with entering the recording mode, READY tracks will be input monitoring and recording can be done while monitoring the recording sound at the recorder output.

**\* The following example shows track 5 in Input Monitoring mode and other tracks in Playback Monitoring mode.**

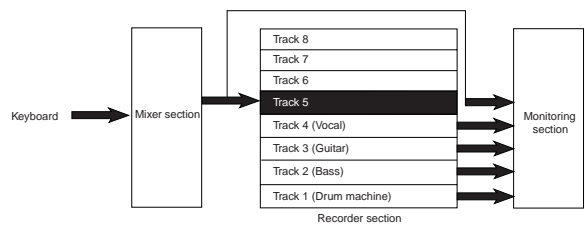

This example shows overdubbing in which the keyboard is recorded on track 5 while tracks 1-4 are being played. Tracks 1-4 are in Playback Monitoring mode and used to check the playback sound. Track 5 is in Input Monitoring mode. You can monitor the recorded sound.

**<Note>**: When in the "Auto EE MD?" menu of the D2424LVmkII SETUP mode, the all input monitor mode can be entered automatically when D2424LVmkII stops. For details, refer to the SETUP mode "Auto EE MD?" menu in page 122.

### Playback monitoring

"Playback monitoring" means to monitor the playback sound of the tracks (only Real tracks). That is, you are monitoring the playback sound on the track, not the sound being recorded to the track.

**\* The following example shows that all tracks are in Playback Monitoring mode.**

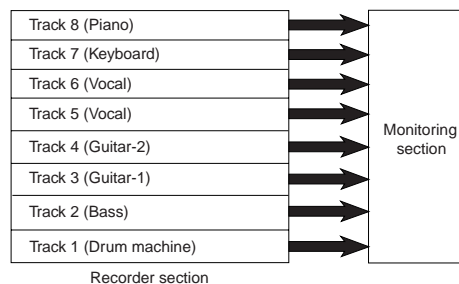

*In this example, all tracks 1-8 are playing the recorded sound in Playback Monitoring mode.*

\* To play the sound on an Additional track, you need to move the data from the Additional track to a Real track. Refer to "Track Exchange function" on page "77" for more information.

## Audio file and event

### <About an audio file>

During recording, the recorder consecutively records an independent audio file (recorded area) in each track of each Program. However, you can record data on the recorder at any point within 24 hours of ABS time, and you can intentionally create silence between two audio files. In this case, a silent part is counted as a 0 file.

Therefore, audio files and 0 files are consecutively created as shown in the diagram below.

The total number of these audio files and 0 files is called “**the number of events.**” The maximum number of events is 512 per track (tracks 1-24). After the number of events reaches 508, new data will not be recorded.

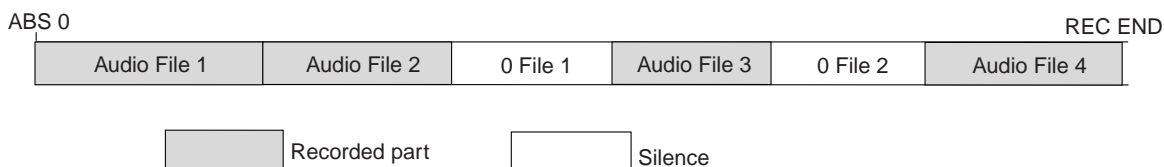

Usually, an event is created by one recording or edit. The number of events increases or decreases depending on the number of edit points or the amount of disk free space. (The recorder disk management operates in such way that the number of events will decrease.) The number of events does not affect usual music production. However, if a small amount of single-track data is written in many different sections on the disk, the maximum number of events may be reached. To avoid this “**event number overflow,**” you need to check the number of events for each track.

The recorder provides an event check menu in Setup mode for this purpose.

**<Notes on digital recording>**  
 During analog recording, “**0 files**” are not created since silence does not create “**data 0.**”  
 However, during S/P DIF and adat digital recording, the recorder records “**data 0**” (this is called “mute recording”).  
 When one second of consecutive data 0 is input to the recorder, it creates a “**0 file**” and limits the consumption of disk space. However, repeating this operation will eventually increase the number of events, leading to “**event number overflow.**”

### What is an event?

As shown in the diagram below, the number of events can be eleven or more if partial recordings are made. This is because an unrecorded part is regarded as an event, and a recorded part is also regarded as an event(s). The duration of each event can vary from 740 msec to 23 hours 59 minutes 59 seconds (FS =44.1kHz).

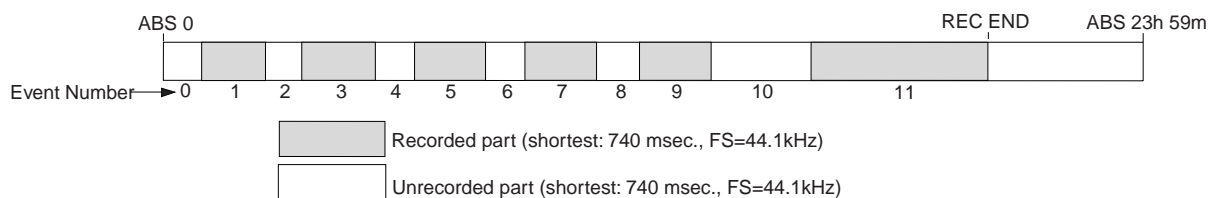

An unrecorded part (zero file) is always regarded as one even, regardless of its duration. However, a recorded part can consist of a group of multiple audio file, as shown in the diagram below. More precisely, one audio file will be divided into multiple audio files if perform many editing operations (such as , copy & paste, move & paste, etc.) on this audio file.

Multiple audio files created in this way are regarded as events. (If you do not edit the data at all, the audio file remains in one piece and is regarded as one event.) In this example, one recorded area consists of six consecutive audio files. This means that this part consists of six events.



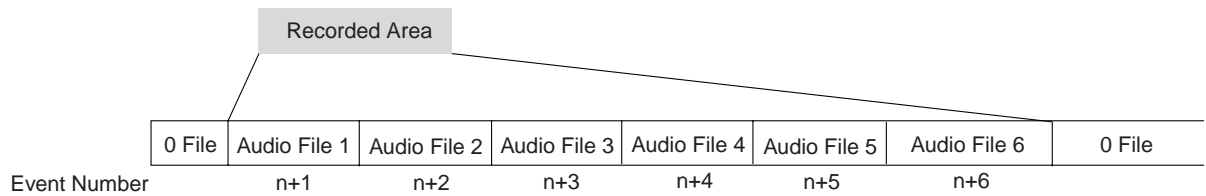

This is because when you perform a copy & paste, move & paste, or Auto Punch In/Out, the event is split at the edit point. Also, if a continuous long recording is made, the recorded data might scatter to different locations on the hard disk, thus dividing the data into multiple events.

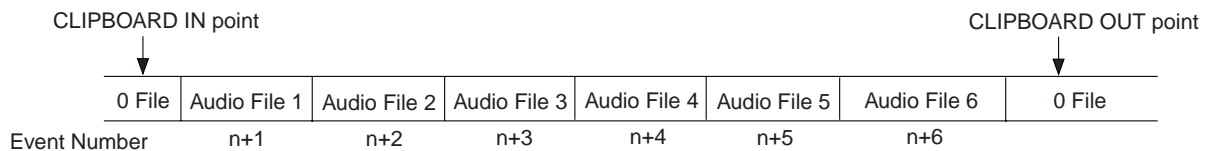

Countermeasures against accumulating too many events due to a long recording plus many editing operations:

One solution is to save and re-load the data to and from a DAT, adat, or a CompactFlash™ card. (If the song is too long, you may not be able to save the data to a DAT or adat.)

In this way, multiple consecutive audio files are optimized into one continuous audio file in some cases. Set the Clipboard In point and the Clipboard Out points within an unrecorded range to copy the area (the area that contains multiple audio files and you wish to optimize) between them, then paste the data starting from the same Clipboard In point. Multiple audio files within this range will become a single audio file.

**<Hints>**

Make sure that you set the Clipboard In/Out points within zero files, and that you paste the area starting from the same Clipboard In point.

\* In any case, bear in mind that you cannot reduce the excessive number of events if the target range contains a zero file.

**<Setup to writable/not writable of the “0 file”>**

There is menu for writing or not of the “0 file” in the SETUP mode of this recorder. At the initial setup, it is set to “Writing in the 0 file (Enable)” but by changing this to “Not writing in the 0 file (Disable),” writing the “0 file” in the disk can be stopped.

By doing so, the above mentioned “event over” can be prevented. For details, refer to SETUP mode in page “121.”

# Formatting and Optimizing Disks

This section describes how to format and optimize a current drive disk and a backup disk. You can also find information regarding formatting and optimizing the disks in the Quick Operation Guide and in the “Saving and Loading Song Data” section of this manual.

## Formatting a current drive disk

Before you format a current drive disk, specify the sampling frequency and bit (data) resolution, Multiple Undo on/off, and format type parameters. Refer to the table below for more information on these settings.

**<Note>**

Normally, the current drive sampling frequency (Hereafter called FS) is setup at formatting. This will continue to be the same for the programs produced in the disk after formatting. However, in this recorder, the FS of each program can be changed to match the application. For details, refer to the “Quick Operation Guide” or the later page “42.”

**<Detailed formatting parameters>**

Sampling Frequency		44.1kHz		48kHz		88.2kHz	96kHz
Quantization		16 bits	24 bits	16 bits	24 bits	24 bits	24 bits
Multiple Undo Function	On	Turn this function on to use the Multiple Undo function for all takes (recordings and edits). This function consumes more disk space. If you are using a small capacity disk, turn this function off.					
	Off	Turn this function off to use the undo/redo function only for the current take (recording or edit). If the capacity of the current drive disk is small, turn this function off.					
Format Type	Standard Format (Default Setting)	The recorder formats a disk while evaluating the integrity of the disk, including the access time for each block on the disk. Time required for formatting is longer, but you can be sure of a highly reliable format. Ordinarily, this format type is selected. This option is displayed and accessible whether you format a new disk or reformat an old disk.					
	Quick Format	With this simple format type, the recorder assumes that all sectors on the hard disk are of good quality. Time required for formatting is shorter, but any bad sectors would not be detected. Select this format type when you format a brand new disk for which Fostex has confirmed quality operation. You can select this format type only when you format a new disk or reformat a disk previously formatted with Quick Format.					
	Erase Format	You can select this format type only when you reformat a disk previously formatted with Standard Format. Use of this format will erase all data on the disk while keeping the Standard Format. Time required for formatting is shorter than when using Standard Format.					
Track architecture		24 real tracks + 32 additional tracks				8 real tracks + 48 additional tracks	
Recording		<ul style="list-style-type: none"> <li>• 24-track simultaneous analog recording</li> <li>• 24-track simultaneous analog (22 tracks) and digital (2 tracks -S/P DIF) recording</li> <li>• 24-track simultaneous analog (16 tracks) and digital (8 tracks - adat) recording</li> <li>• 24-track simultaneous adat digital recording</li> </ul>				<ul style="list-style-type: none"> <li>• 8-track simultaneous analog recording</li> <li>• 8-track simultaneous analog (6 tracks) and digital (2 tracks - S/P DIF) recording</li> </ul>	
Save/Load		<ul style="list-style-type: none"> <li>• Saving and loading data via adat or S/P DIF digital signal</li> <li>• Saving and loading data via CompactFlash™ card (FDMS-3 or WAVE)</li> <li>• Saving and loading data via E-IDE hard disk drive (FDMS-3 or WAVE)</li> </ul>				<ul style="list-style-type: none"> <li>• Saving and loading data via CompactFlash™ card (FDMS-3 or WAVE)</li> <li>• Saving and loading data via E-IDE hard disk drive (FDMS-3 or WAVE)</li> </ul>	



**<Available recording time after formatting>**

A greater sampling frequency will reduce the available recording time/space after formatting. Under the same sampling frequency setting, the greater quantization (bit number) reduces the available recording time. The following table shows the "approximate available recording time" under each sampling frequency/quantization. Depending on your medium, the available recording time may differ slightly. It will be a good idea to check the available recording time after formatting.

Capacity	44.1kHz		48kHz		88.2kHz	96kHz
	16 bits	24 bits	16 bits	24 bits	24 bits	24 bits
10.0GB	Approx. 1888 min.	Approx. 1258 min.	Approx. 1735 min.	Approx. 1156 min.	Approx. 628 min.	Approx. 577 min.

**Formatting a brand new hard disk (Current drive)**

This section describes how to format an E-IDE hard disk used for the current drive, assuming that a hard disk has already been installed in the recorder. To format a CompactFlash™ card (or the optional E-IDE hard disk drive), follow the procedure described in page 35.

- (1) **Turn on the power to the recorder.**

The recorder displays the ROM version, time and date, then displays "Initializing...", "Current IDE Drv", "(model name of the hard disk)" in this order, then "Unformat!" momentarily. Finally, the unit displays the "Disk Format?" menu in Setup mode, showing the following screen.

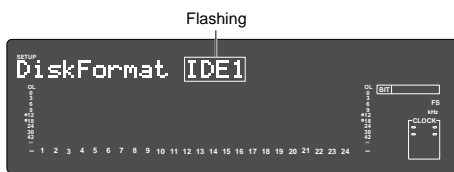

- (2) **Press the [EXECUTE/YES] key.**

The model name of the current E-IDE hard disk and "?" flash on the screen.

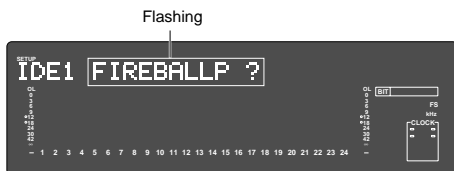

- (3) **Press the [EXECUTE/YES] key again.**

The recorder displays the screen that enables you to set the sampling frequency and bit resolution. (With the default setting, "44.1kHz 24bit?" appears.) Refer to the table on page 31 and turn the Jog dial to select the desired setting.

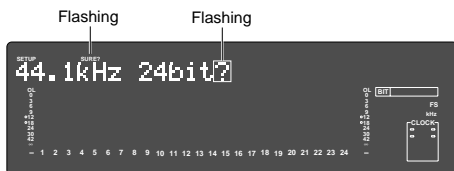

- (4) **After you select the desired sampling frequency and bit resolution using the Jog dial, press the [EXECUTE/YES] key.**

The recorder displays the screen which enables you to set the Multiple Undo function on or off.

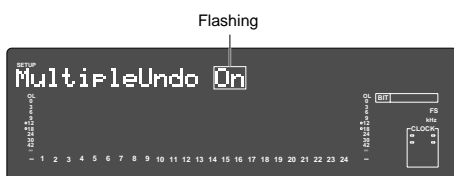

**<Note>**: It is recommended to enable the multiple undo function. When it is enabled, you can go back to the any previous take by specifying the date and time when you made the take (time jump function). See page 69 for details about the multiple undo function.

- (5) **After setting the multiple undo function on or off using the Jog dial, press the [EXECUTE/YES] key.**

The recorder displays the screen which enables you to select the format type. With the default setting, "Standard Format?" appears. Be sure to select "Standard Format?" to format an unformatted disk.

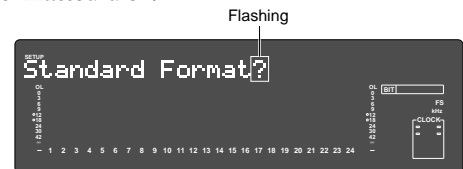

- (6) **Press and hold down the [RECORD] button and press the [EXECUTE/YES] key.**

The recorder starts formatting the disk, and displays the size of the unformatted area on the target disk. This value counts down as the formatting operation proceeds. Wait until the format operation is complete.

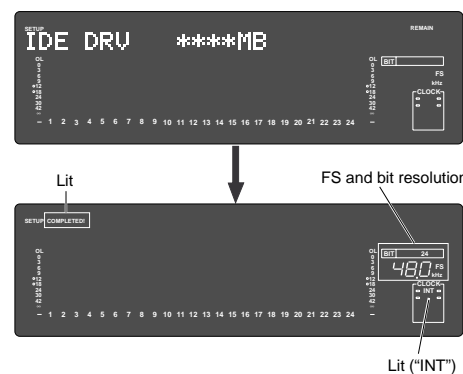

- (7) **After formatting is complete, press the [EXIT/NO] key (or the [STOP] button).**

## Re-Formatting the Current Drive

Follow procedures below to re-format the current drive.

- Turn on the power to the recorder.**  
The recorder starts with an indication of the beginning (Timebase: ABS 0) of the program that was selected before the power was turned off. Even if a back-up E-IDE hard disk is installed, the current drive starts up when the power is turned on.

- Press the [SETUP] key to put the recorder into Setup mode.**

- Use the Jog dial to select "Disk Format ?" and press the [EXECUTE/YES] key.**  
"IDE1" flashes in the same way mentioned in "Formatting a new disk."

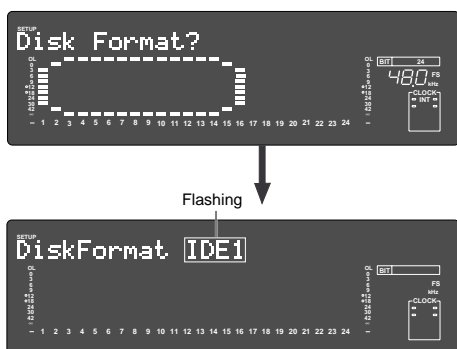

- Press the [EXECUTE/YES] key while "IDE1" is flashing.**  
The model name of the current drive's hard disk appears and "SURE ?" flashes.

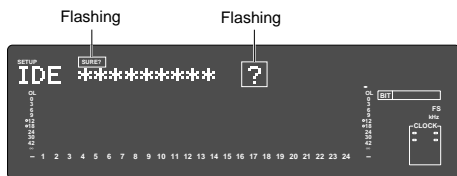

- Press the [EXECUTE/YES] key.**  
The recorder displays the screen that enables you to set the sampling frequency and bit resolution.

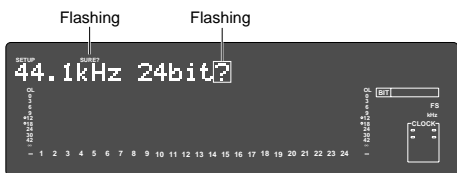

- Select the desired sampling frequency and bit resolution using the Jog dial, and press the [EXECUTE/YES] key.**  
The recorder displays the screen which enables you to set the Multiple Undo function on or off.

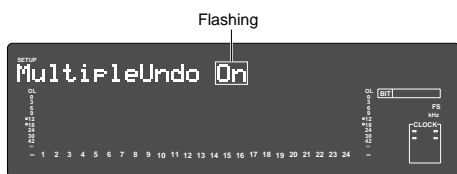

**<Note>:** It is recommended to enable the multiple undo function. When it is enabled, you can go back to the any previous take by specifying the date and time when you made the take (time jump function). See page 69 for details about the multiple undo function.

- Set the Multiple Undo function on or off using the Jog dial, and press the [EXECUTE/YES] key.**

The recorder displays the screen which enables you to select the format type. If you have formatted the disk with Standard Format, you can select either Standard Format or Erase Format. If you have formatted the disk with Quick Format, you can select either Standard Format or Quick Format.

Be sure to select "Standard Format?" to format a back-up E-IDE hard disk.

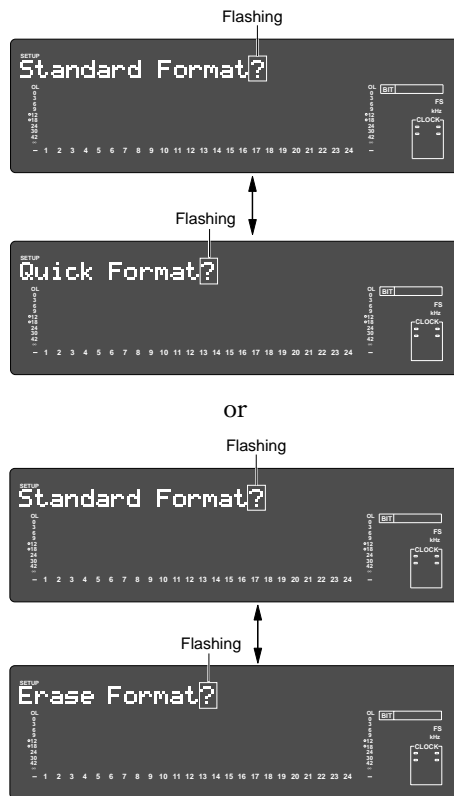

- Use the Jog dial to select the desired format type, then press and hold down the [RECORD] button and press the [EXECUTE/YES] key.**  
The recorder starts formatting the disk.
- After formatting is complete, press the [EXIT/NO] key (or the [STOP] button).**

## Formatting a backup medium (CompactFlash™ card or optional E-IDE hard disk drive)

You can format a backup medium (a CompactFlash™ card or optional E-IDE hard disk) in "24 bit backup" or "16 bit backup" mode or in "DOS" format.

When a medium is DOS-formatted, FAT 16 or FAT 32 standard is automatically selected according to its storage capacity (see the following for details about DOS formatting).

### About FAT 32 format

When you use the D2424LVmkII to DOS-format a medium (CompactFlash™ card or optional E-IDE hard disk) with the storage capacity between 530 MB and 320 GB, it is automatically formatted in FAT 32 standard.

On the FAT 32 formatted medium, the "D2424LVmkII" folder is created in the root folder and some folders are automatically created under the "D2424LVmkII" folder as shown below.

The WAV folder is used for storing WAV files, while the BACKUP folder is used for storing binary data (DAT files) for backup of the FDMS-3 (Fostex Disk Management System-3). See page 94 for details about saving/loading using a FAT 32 formatted medium.

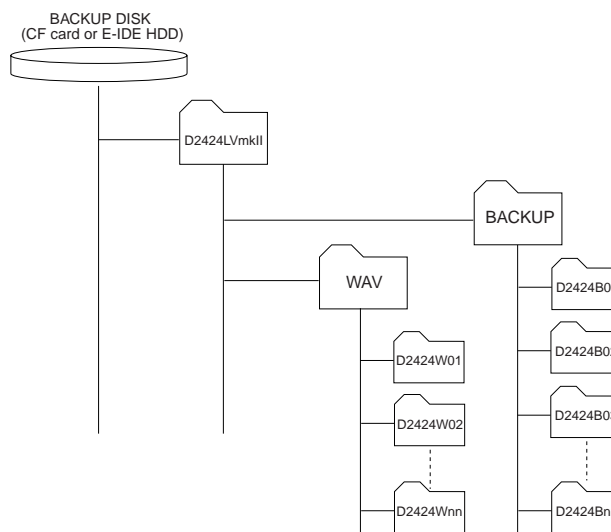

**<Note>**: The D2424LVmkII can use up to 320 GB disk space. Therefore, if you DOS-format a hard disk drive of more than 320 GB capacity using the D2424LVmkII, you can use only 320 GB of the disk space with the D2424LVmkII.

**<Note>**: Do not write any data other than D2424LVmkII data to the area formatted by the D2424LVmkII.

**<Note>**: When you format a hard disk drive with more than 320 GB (for example, 500 MB) using the D2424LVmkII, the area which is not used by the D2424LVmkII can be used by a personal computer for other purposes. However, by executing save or load operation from the D2424LVmkII, data written by a computer may be destroyed. Therefore, we recommend not using the area which is not used by the D2424LVmkII.

### About FAT 16 format

When you use the D2424LVmkII to DOS-format a medium (CompactFlash™ card) with the capacity between 128 MB and 529 MB, it is automatically formatted in FAT 16.

Unlike a FAT 32 formatted medium, no folder is created in the FAT 16 formatted medium. You can only save or load WAV files. See page 98 for details about saving/loading using a FAT 16 formatted medium.

The following procedure shows how to format a CompactFlash™ card for backup. You can format an E-IDE hard disk instead of a CompactFlash™ card in the similar manner. For details about save/load operation using a CompactFlash™ card or E-IDE hard disk, see page 96.

- (1) Press the [SETUP] key to put the recorder into Setup mode.
- (2) Turn the Jog dial to select the "Disk Format?" menu and press the [EXECUTE/YES] key. "IDE1" flashes.

To format a CompactFlash™ card (or E-IDE hard disk) for backup, you have to select "IDE2".

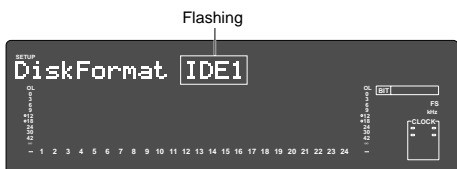

- (3) Use the Jog dial to select flashing "IDE2" and press the [EXECUTE/YES] key.

The display shows the name of the CompactFlash™ card currently set to the CF drive, as well as flashing "?" and "SURE?".

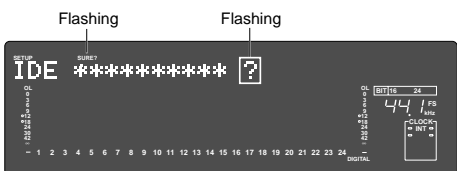

**<Note>**: When an E-IDE hard disk is set as a backup medium, the name of the hard disk drive is shown.

- (4) Press the [EXECUTE/YES] key again. The display shows the backup format mode (by default, "DOS Format"). You can select the backup format mode between "DOS Format" and "24bit Backup" or "16bit Backup" depending on the bit depth setting of the current drive.

To enable WAV file saving/loading, select "DOS Format". To enable FDMS-3 saving /loading, select "24bit Backup" (or "16bit Backup").

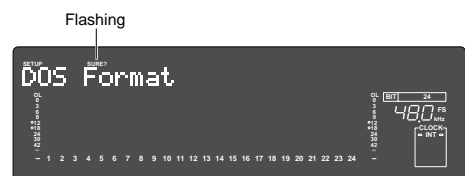

**<Bit resolution>**  
The same figures in quantization of the current drive will be displayed for quantization of the backup format. Thus, when the current drive is 24bit, "24bit Backup?" will be displayed, and for 16bit, "16bit Backup?" will be displayed.

- (5) Use the jog dial to select the format mode, and press the [EXECUTE/YES] key while holding down the [RECORD] key.

**<When selecting "DOS Format">**

The unit starts formatting in "FAT16" or "FAT32" depending on the capacity of the medium. When formatting is completed, the display shows "COMPLETED!".

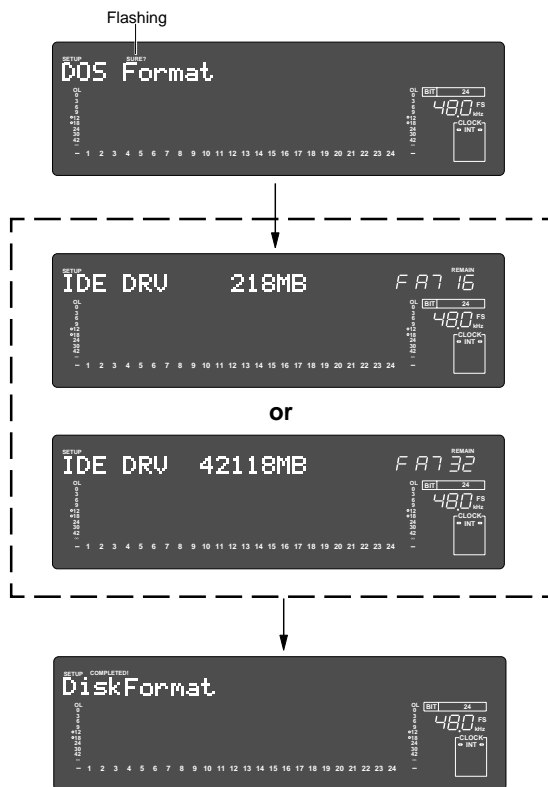

**<When selecting "24bit Backup" or "16bit Backup">**

The unit starts formatting. When formatting is completed, the display shows "COMPLETED!".

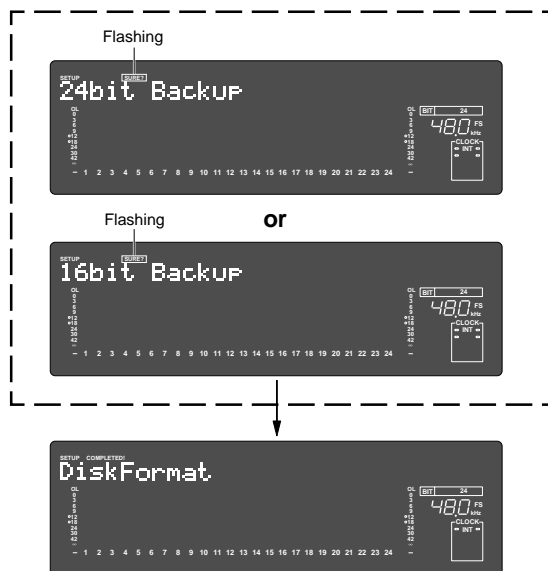

- (6) Press the [EXIT/NO] key (or the [STOP] button) to exit Setup mode.

The recorder displays the time base value of the current drive that was shown before the unit entered Setup mode.

**Optimizing the disk**

If you are using a disk that was formatted with the Multiple Undo function turned on, free disk space becomes smaller quickly because the disk always keeps the Multiple Undo files. Optimizing such a disk (using the “Disk Optimize?” menu in Setup mode) will increase free block space.

**<Notes>**

- After you record multiple takes, if you optimize the disk (with the Multiple Undo function turned on), you will be able to undo only the most recent take. Therefore, if you wish to keep some takes, perform the Multiple Undo function or use the Program duplicate function to restore the take, then optimize the disk. For more information, see “Multiple Undo Function” on page 69.
- After executing a format conversion via the “Additional track format conversion” menu in the SETUP mode, the recorder will automatically enter the “Disk Optimize?” menu. Therefore, we recommended that you optimize the disk immediately after format conversion. By optimizing, the multiple undo history of tracks 25-56 will be erased and disk memory space may increase. For details on additional track format conversion, refer to page “127.”

- (1) While the disk is not being accessed, press the [SETUP] key to put the unit into Setup mode.
- (2) Turn the Jog dial to select the “Disk Optimize?” menu and press the [EXECUTE/YES] key. The recorder displays the following indication and “SURE ?” flashes.

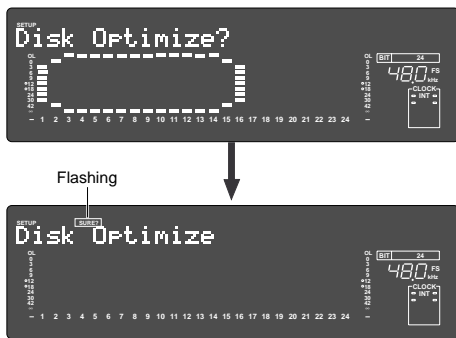

- (3) Press and hold down the [RECORD] button and press the [EXECUTE/YES] key. The disk optimize function starts. When it is complete, “COMPLETED!” lights up.



- (4) Press the [EXIT/NO] key (or [STOP] button) to exit Setup mode.

# Handling Programs

This chapter explains how to handle Programs. It covers the following topics:

1. Creating a new Program
2. Using a Program Change function
3. Duplicating a Program
4. Deleting a Program
5. Editing a Program title
6. Changing the program FS

## Creating a new Program

You can manage individual songs by setting multiple programs on the disk, as explained in the “Managing Songs by Program Selection” section of the “Before Starting” chapter. You can set up to 99 Programs. One Program is automatically created on the disk when the disk is newly formatted with this equipment. Follow the steps below to create a new Program. The prerequisite of this operation is that the disk is in an “initial state” where there is only one Program on the disk.

**<Note>**

- When a new program is made, the same initial setup of the currently active program will be copied as the initial setting for the new program. If you wish to make a new program under the same settings as those of a previous program, call up the desired program to be copied before making the new program.
- A new compilation is possible only when the "Chain Play?" (Setup of the chain play mode) menu in the SETUP mode is set to "Off." If the [PGM SEL] key is pressed when the "Chain Play?" menu is set in other than the "Off" mode, the D2424LVmkII will enter the "Chain play mode." Before starting compilation, check that the "Chain Play?" is "Off" and if it is not, be sure to reset it to "Off."

- (1) **Turn on the power to the recorder.**  
 Upon starting up the recorder, “Initialize...”->  
 “Current IDE Drv” -> “Hard disk model number”->  
 “Storage mode (Standard format in this case)  
 messages are followed with an ABS time base, then  
 show the top of the Program (ABS 0).  
 At this time, the current Program is indicated as  
 “P01”.

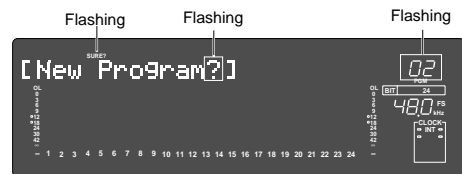

- (2) **Press the [PGM SEL] key.**  
 “Select PGM!” appears on the display briefly, then  
 changes to a flashing “01” and “SURE?” flash.  
 (“\*\*\*\*\*” is the name of PGM 01.)

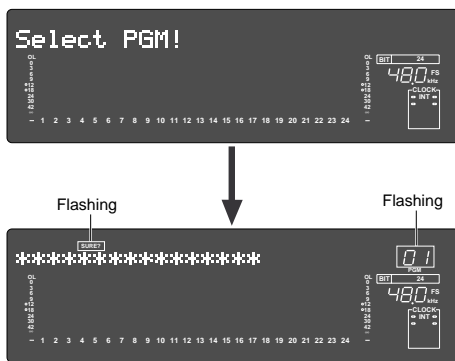

- (4) **Press the [EXECUTE/YES] key.**  
 The recorder automatically enters “Title Edit PGM?”  
 menu in SETUP mode.  
 You can enter a title for Program 2. (“?” flash.)  
 If you prefer the default name, press the [EXIT/NO]  
 key.

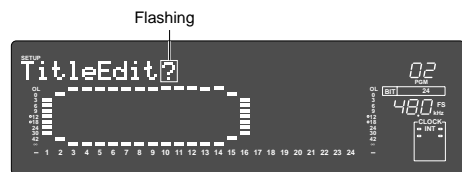

- (3) **Turn the Jog dial clockwise.**  
 The question marks “?” of “[New Program?]” and  
 “SURE?” flash. This indication asks you if you wish  
 to set a new Program (Program 2).

- (5) **Press the [EXECUTE/YES] key again.**  
 A default title (#0002) appears on the display, with  
 “#” and “SURE?” flashing.  
 This means that you can enter a name for the new  
 Program.  
 If you wish to name the Program with a unique title,  
 continue the steps below.  
 In either case, you can change the title later, as  
 explained in “Editing a Program title.”

**To enter a title:**

- Turn the Jog dial, or pressing the [NEXT] key and [PREV] key for the flashing cursor to voluntarily input alphanumerics.

Press the [PREV] key/[NEXT] key and the recorder will jump to the letters/symbols listed below (small square position).

- Move the flashing cursor with the Shuttle dial.
- You can input the following alphanumerics and symbols.  
Titles can contain up to 16 alphanumeric characters.

```

# $ % & ' ( ) * + , - . / 0 1 2 3 4
5 6 7 8 9 : ; < = > ? @ A B C D E F
G H I J K L M N O P Q R S T U V W X
Y Z [ \ ] ^ _ ` a b c d e f g h i j
k l m n o p q r s t u v w x y z { |
} ~ + _ ! "
    
```

- (6) When you finish entering the title, press the [EXECUTE/YES] key.  
Program 2 (PGM 02) and its title are set. The display shows the ABS Time Base indication of the Program.
- (7) Press the [EXIT/NO] key, or [STOP] button.

**<Important!>**

- When you create a new Program by selecting the "New PGM ?" menu, a new Program is created with an increment number.  
That is, if only one Program exists and when you create a new Program, it will be named Program 2. If Programs 1-5 already exist, a new Program number will be 6.
- Remember that producing new programs gradually decreases recordable disk space. If disk space is insufficient, or if 99 programs have already been created, you cannot create more new programs. If a new program is attempted, "Can't New PGM!" will indicate that the operation is invalid.

**Duplicating a Program**

Any program content (Recording data/various setup items) can be duplicated but with a separate program number.

**<Notes>**

- \* Duplicating a program is possible only when the Multiple Undo function is set to ON when formatting the current drive. In a current drive with this setting at OFF, the "PGM Duplicate?" message will not display when pressing the [EDIT] key mentioned below.
- \* The program which can be duplicated must be the currently active program. Therefore, the program you wish to duplicate must be activated prior to executing the duplicating mode.

- (1) With this recorder in the stop mode, press the [EDIT] key to display "PGM Duplicate?" ("?" flashes).

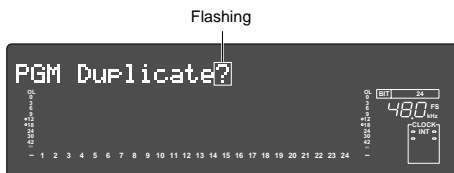

- (2) Press the [EXECUTE/YES] key. As an example, the following is displayed and "SURE?" will flash. This means that program 01 will be duplicated for program 05, the new program 05. Refer see <Note> below.



- (3) Press the [EXECUTE/YES] key again. The display will change to head of the duplicated original program (P01 in this example), and "COMPLETED!" will light.
- (4) Press the [EXIT/NO] key (or [STOP] button). "COMPLETED!" will be extinguished.

By following these procedures, the same content in program 01 is duplicated in program 05.

**<Note>:** The program to be duplicated will be assigned with a program number following that of the program presently existing in the disk. If "Duplicate P01 > 05" is displayed as in the previous example, this indicates that four programs presently exist in the disk and that the new program will be number 05. If the duplicated program is to be checked or you wish to switch to this program, refer to the next item "Selecting a program."

## Using a Program Change function

If multiple Programs exist on the disk, you need to select a Program to record, play, or edit. This section describes how to select a Program.

### <Notes>

- You cannot use the Program Change function when the recorder is in SETUP mode.
- The program change is possible only when the “Chain Play?” (Setup of the chain play mode) menu in the SETUP mode is set to “Off.” If the [PGM SEL] key is pressed when the “Chain Play?” menu is set in other than the “Off” mode, the recorder will enter the “Chain Play mode.” Before starting program change, check that the “Chain Play?” menu is “Off” and if it is not, be sure to reset it to “Off.”

(1) When the recorder is stopped, press the [PGM SEL] key.

“Select PGM!” appears on the display briefly, then changes to a flashing “01” and “SURE?”. (“\*\*\*\*” is the name of PGM 01.)

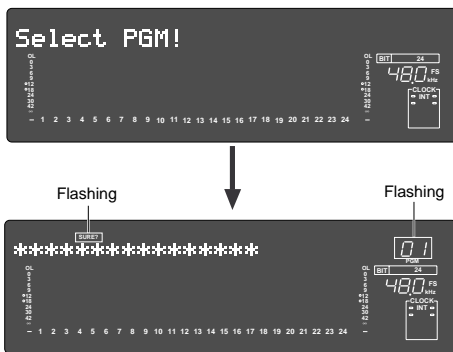

(2) Turn the Jog dial to select the desired Program number (flashing).

Rotating the Jog dial counter-clockwise decreases the number, and rotating it clockwise increases the number.

If you turn the Jog dial clockwise all the way, “New Program?” will be selected. Select “New Program ?” to create a new Program as mentioned in the previous section “Creating a new Program.”

(3) Press the [EXECUTE/YES] key.

The ABS Time Base indication for the selected Program appears.

In this way, you can be sure to select a Program before you start working.

## Deleting a Program

This section explains how to delete an unnecessary Program.

Deleting an unnecessary Program will expand the recordable area, making your work flow more smoothly, since recording or editing requires sufficient recordable area (free space on the disk). Use the “Delete PGM ?” menu in SETUP mode to delete a Program.

### <Notes on deleting a Program>

- You can delete only the currently-selected Program. Refer to the previous section, “Using a Program Change function,” for information on how to select the desired Program before you proceed to delete the Program.
- If only one Program exists and you try to delete it, data contained in the Program will be deleted, but the Program itself will remain.  
For example, assume that PGM 01 -07 exist and you try to delete PGM 05. Program number 05 will remain, but the data inside PGM 05 will be replaced with the data of PGM 06. The subsequent Programs’ data will move in the same way. Therefore, it will appear that PGM 07 has been deleted. If you delete the last Program (PGM 07 in this example), PGM 07 will be completely deleted.

If you try to deleted PGM 05, only the data of PGM 05 will be deleted and the data of PGM 06 will move into PGM 05.

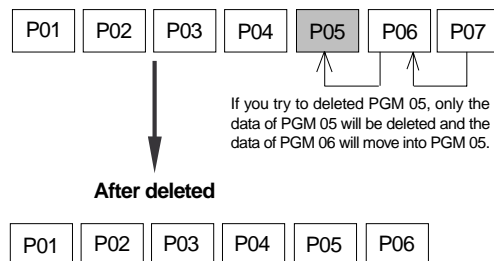

**<Note>**: You cannot use the Single Undo/Redo function, and Multiple Undo function to delete Programs. Make sure that you delete the correct Program.



- (1) Press the [SETUP] key while the recorder is stopped, to put the system in the SETUP mode.
- (2) Turn the Jog dial to select the first hierarchy of the "Delete PGM \*\* ?" (deleting a Program) menu.  
Alternatively, you can use the Shuttle dial, [REV] key, or [NEXT] key.

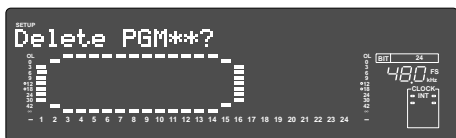

- (3) Press the [EXECUTE/YES] key.  
The display will change and "SURE?" will flash? This indicates that the system is in the stand-by state to delete a program that is currently started up.



To cancel the delete operation, press the [EXIT/NO] key while "SURE?" is flashing. Each time you press the button or key, the recorder will return to a higher level in the hierarchy, and finally exit SETUP mode.

- (4) Press the [EXECUTE/YES] key again.  
When the recorder displays "Deleting..." and finishes deleting the Program, the data of the next Program number moves in, and its ABS time appears.
- (5) Press the [EXIT/NO] key, or [STOP] button.

To check the REMAIN time and free space, press the [DISP SEL] key to display the "REMAIN" indication after the Program is deleted.

### Editing a Program title

You can name the Program as explained in the "Creating a new Program" section. You can also change the title later by using the "Title Edit ?" menu in SETUP mode.

**<Note>:** You can edit the title of the selected Program before you select SETUP mode. You cannot select a Program after the recorder enters SETUP mode. Be sure to select the desired Program using the steps explained in the "Using the Program Change function" section.

- (1) Press the [SETUP] key while the recorder is stopped, to put the system in the SETUP mode.
- (2) Turn the Jog dial to select the first hierarchy level of the "Title Edit ?" ("?" flash.) menu.

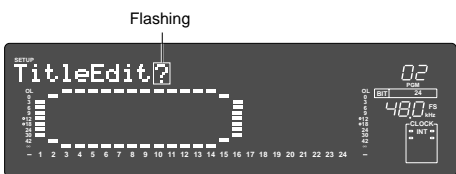

- (3) Press the [EXECUTE/YES] key.  
The currently-selected Program title appears with the left-most character flashing.



- (4) Move the flashing cursor with the Shuttle dial and input the letter or number with the Jog dial / [NEXT] key / [PREV] key.  
Up to 16 digits and the following letters / numbers / symbols can be input.

Press the [PREV] key/[NEXT] key and the recorder will jump to the letters/symbols listed below (small square position).

```

##%&'()*+,-./0123456789
:;<=>?@ABCDEFGHIJKLMNPO
Q RSTUVWXYZ[*]^_`ab cdefg
hijklmnopqrstuvwxyz(|)+
<[ ]! "
    
```

- (5) After you enter the title, press the [EXECUTE/YES] key.  
The new title is confirmed, and the ABS time value of the Program appears.
- (6) Press the [EXIT/NO] key, or the [STOP] button.

## Changing the program FS

Normally, when a new program is produced on the disk, this program will be made using the same sampling frequency and quantization figures set when the disk was last formatted.

As explained in the separate sheet “**Quick Operation Guide**,” the recorder’s FS can be changed subsequent to producing the program, so that it will be suitable for the application. However, the changing the FS will be limited by the quantization figure used at formatting.

**<Note: There is a limit to FS’s which can be changed!>**

The following FS is limited, depending on the quantization figure (16 bit or 24 bit) set when formatting the current drive.

- \* 16 bit current drive -> 44.1kHz or 48kHz
- \* 24 bit current drive -> 44.1kHz, 48kHz, 88.2kHz or 96kHz

**<Notes>**

- FS can converted only in the program that is currently active. Do not change the FS of a program that has been finished. Prerecorded data cannot be guaranteed.
- Do not copy & paste track data between programs with different FS.  
Fostex does not guarantee song data which is created using the copy & paste function between programs with different FS.

- (1) **Press the [SETUP] key while the recorder is stopped, to put the system in the SETUP mode.**
- (2) **Turn the Jog dial to select the first hierarchy level of the “Sample Rate?” (“?” flash.) menu, and then press the [EXECUTE/YES] key.**  
The currently-set FS will flash.

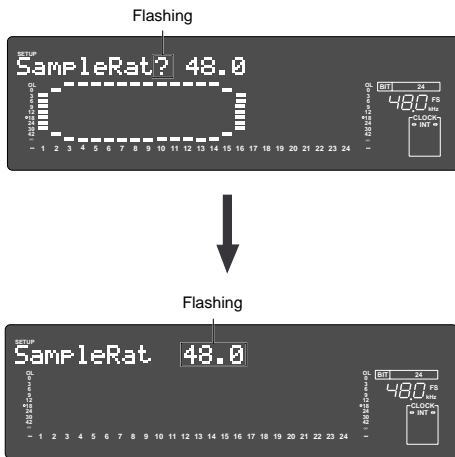

- (3) **Select the desired FS via the Jog dial and press the [EXECUTE/YES] key.**  
Either 44.1 or 48 can be selected in a 16 bit program and any one of 44.1/48/88.2/96 can be selected for a 24 bit program. Pressing the [EXECUTE/YES] key will set the selected FS and change the display to the “Sample Rate?” menu.
- (4) **Press the [EXIT/NO] key, or the [STOP] button.**  
The recorder will change to the head (ABS 0) of the Normal display.

**<Note>:** If you change the FS (44.1 or 48kHz) of a program in the 24-track mode to 88.2 or 96kHz, the program automatically changes to the 8-track mode and track numbers 1 through 8 on the display are lit. The following shows display examples when changing the FS of a 48-kHz/24-bit program to 96kHz.

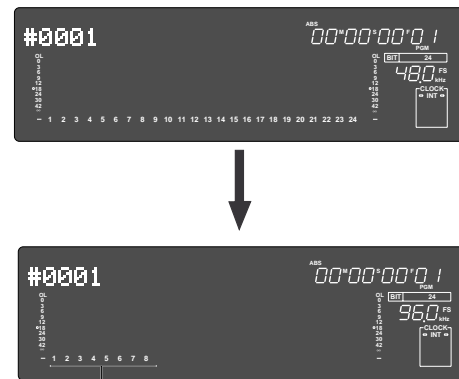

Track numbers 1 through 8 are effective.

Also, note that if you change a program recorded in the 24-track mode to an FS of the 8-track mode, tracks 1 through 8 can be used as real tracks, however, tracks 9 through 24 are data for additional tracks. In other words, you cannot playback song data on track 9 through 24 in realtime. To playback tracks 9 through 24, use the track exchange function to move data to real tracks.

# Punch In/Out

## What is Punch In/Out recording?

Punch In/Out recording enables you to record over previously-recorded parts. See the diagram below. For example, using the Punch In/Out function allows you to change an unsatisfactory guitar solo. The D2424LVmkII offers two types of Punch In/Out functions. One is called **Auto Punch In/Out**, in which you automatically re-record a specified part.

The other is called **Manual Punch In/Out**, in which you record data manually (using your foot to operate an optional foot switch, model 8051). Both functions feature “**Rehearsal mode**” to enable you to practice repeatedly until you are ready.

- Select a Program for Punch In/Out recording.
- Initialize the recorder.
- Check a sampling frequency of the recorder and external device.

### <Notes>

- You can use the Punch In/Out recording only for Real tracks. If you wish to use Punch In/Out recording for data on an Additional track, first move the data to the Real tracks.
- Before doing punch in/out, check that the SETUP mode “Chain Play?” menu is “Off.” If it is set in other than “Off,” chain play will be executed.

## Auto Punch In/Out

To perform Auto Punch In/Out recording, you need to specify the Auto Punch In point (recording start point) and the Auto Punch Out point (recording end point).

### Preparation

#### Storing the edit points

- (1) **Refer to “Storing the edit points” to set the Auto Punch In/Out points.**  
Store the Auto Punch In point to the [AUTO PUNCH IN] key, and the Auto Punch Out point to the [AUTO PUNCH OUT] key.

- Refer to page “54” for more information on storing the edit points.

**<Note>**: Make sure that you specify an Auto Punch In point that precedes the Auto Punch Out point. If the Auto Punch Out point precedes the Auto Punch In point, “Void Out!” appears and you will be unable to perform Auto Punch In/Out recording.

#### Previewing and trimming the edit points

You can check the stored edit points by pressing the corresponding memory keys to display them on the LCD. You can also change the points if necessary.

In this example, use the Preview function to fine-tune the point while previewing.

- (1) **While the recorder is stopped, hold down the [SHIFT] key and press the memory key.**  
Pressing the [AUTO PUNCH IN] key enables you to listen to the sound at the AUTO PUNCH IN point (“previewing the sound rise [fade-out]”). Pressing the [AUTO PUNCH OUT] key enables you to listen to the sound at the AUTO PUNCH OUT point (“previewing the sound fall [fade-in]”).
- (2) **Trim the edit point while auditioning the sound.**

- Refer to page “67” for more information on the Preview function.

## Rehearsing Auto Punch In/Out recording

In Rehearsal mode, the READY track assumes input monitoring mode between the Auto Punch In and Out points, and the sound is not recorded. You can practice Auto Punch In/Out operation repeatedly before you proceed to actual recording. Locate the recording start position slightly before the Auto Punch In point.

### <Tips for rehearsal>

Set the preroll value while referring to the “**Changing the Initial Settings (SETUP Mode)**” chapter. In this way, the recorder can locate a point that precedes the Auto Punch In point by the specified preroll value. This enables you to start playback slightly before the Punch In point. (Refer to page “108” for more information on “Changing the Initial Settings.”)

The recorder will repeat playback data between the AUTO RTN START point and the AUTO RTN END point if you set the AUTO RTN START point before the Auto Punch In point and the AUTO RTN END point after the Auto Punch Out point. This allows you to repeat rehearsal. See the “**Hint-2.**”

- Press the [AUTO PUNCH] key.**  
The AUTO PUNCH mode will turn ON. The REHEARSAL LED (green) and TAKE LED (red) of the [AUTO PUNCH] key will flash.



- Set the track for Auto Punch In/Out to READY.**  
Press the [RECORD TRACK] select key [3/11/19] to set track 3 to READY.

- Start playback of the recorder from a point slightly before the Auto Punch In point.**  
Only the REHEARSAL LED (green) will light up, and start rehearsal. The recorder operates as shown in the figure below during rehearsal operations.

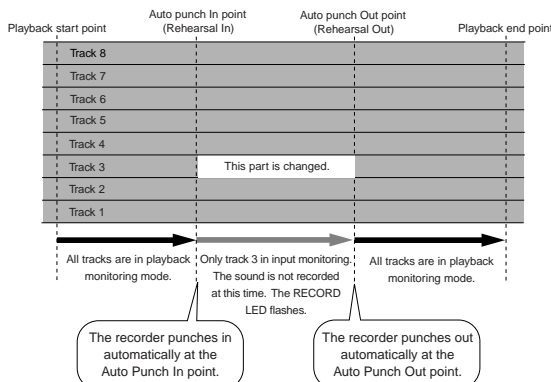

- Play the guitar accompanying the playback sound from tracks 1 - 8 for rehearsal, while adjusting the recording level.**

You will hear the guitar performance between the Auto Punch In and Out points. Otherwise, you will hear the recorded guitar sound.

- When you are satisfied with your rehearsal, press the [STOP] button.**

### <Hint 1>

#### Locating a point slightly before the Auto Punch In point

To locate the playback start point for rehearsal, press the [AUTO PUNCH IN] key, then press the [LOCATE] key. The recorder displays the time (position) stored in the [AUTO PUNCH IN] key, and locates the point and stops. Press the [REWIND] button to go backward. If you have set the preroll time as described on page “113,” you can locate a point that precedes the Auto Punch In point by the specified preroll value.

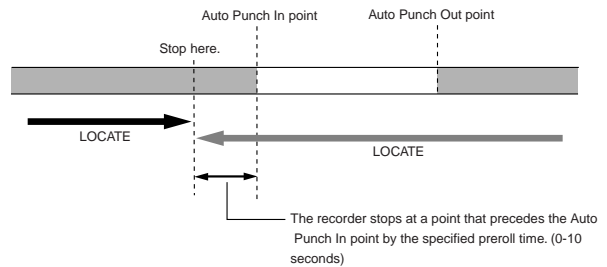

### <Hint 2>

#### Quick and easy operation for repeated rehearsal

Using the Auto Return function and the Auto Play function enables you to rehearse repeatedly. As shown below, set the AUTO RTN START and END points for Auto Return and Auto Play. In this way, you can repeat rehearsal easily, while checking the recording level and concentrating on your performance. Refer to page “54” for more information on setting the AUTO RTN START/END points.

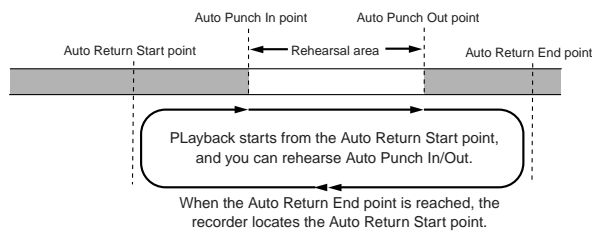

**<Note>:** If the recorder displays “Over!” when you turn on the Auto Punch mode, the disk does not have enough free space to perform Auto Punch In/Out. In such a case, erase any unnecessary sections, delete unnecessary program data or optimize the disk and execute again.

### Auto Punch In/Out Take

After you are satisfied with your rehearsal, you can proceed to an actual take of Auto Punch In/Out. You can undo or redo Auto Punch In/Out recording if you change your mind.

The control panel settings are the same as those for rehearsal.

- (1) Press the [RECORD TRACK] select key [3/11/19] to set track 3 to READY.
- (2) Locate a point slightly before the Auto Punch In point.
- (3) Confirm that Auto Punch mode is turned on. Press the [AUTO PUNCH] key to turn on the function, if it is not already on (REHEARSAL/TAKE LED flashes).
- (4) Press the [RECORD] button while holding down the [PLAY] button. Only TAKE LED (red) lights up and starts TAKE.

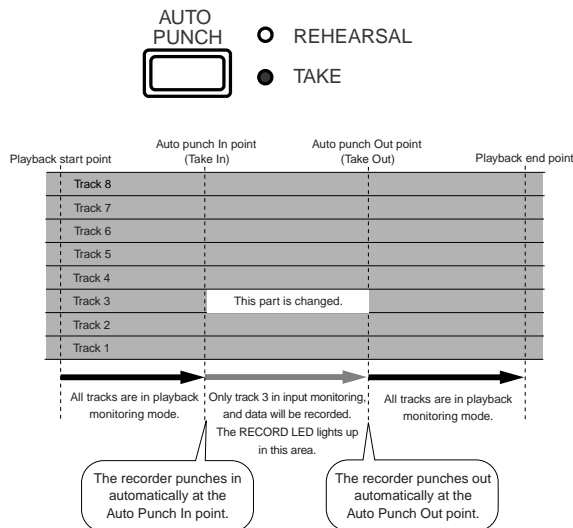

- Track 3 indication on the display will only light up between the AUTO PUNCH IN/OUT point, and will flash in any other case.
- When the Auto Punch Out point is passed, the recorder cancels Auto Punch mode automatically, and nothing appears in the A. PUNCH display area.

#### <Caution after Punch Out>

In an FS=44.1kHz program, the simultaneously recordable number of tracks is a maximum of 8. In an FS=88.2/96kHz program, the maximum is 2 tracks in which "seamless punch out" without mute can be executed. In simultaneous recording beyond this number, the recorder will be muted for 3-5 seconds after punch out but during actual recording, it will be a seamless punch out. Depending on the speed of the hard disk being used, when recording a fewer number of simultaneous tracks than mentioned above, the recorder will also be muted, but this poses no problem during actual recording.

- (5) When you finish recording, press the [STOP] button.
- (6) Play track 3 to check the result of the Auto Punch In/Out operation. If you fail with AUTO PUNCH IN/OUT and are not satisfied, repeat the process by performing the AUTO PUNCH IN/OUT undo operations described in the next section.

### Single Undo/Redo

You can single undo or redo Auto Punch In/Out recording.

Press the [UNDO/REDO] key after recording is complete to restore the conditions that existed prior to the recording.

Press the [UNDO/REDO] key again to restore the conditions that existed after the recording.

However, the procedures explained here is for Single Undo/Redo and there are limitations as written in the Notes below. If the current drive was formatted with the multiple undo function ON, Multiple Undo is also possible.

Refer to page "69" for details on the Multiple Undo function.

#### <Notes at executing single undo/redo>

**Note-1:** This function only works when this recorder is in the stop mode.

**Note-2:** After finishing auto punch in/out, please note that single Undo/Redo is not possible if the following have been executed.

- If a new recording has been made.
- When a new editing job is executed (such as Copy & Paste, Move & Paste, or Erase).
- When in the AUTO PUNCH ON mode, when the AUTO PUNCH IN point is passed in the PLAY (or RECORD) mode.
- If the power was switched off.
- If program select was executed.
- When multiple undo is executed.

## Manual Punch In/Out

This section explains how to perform Manual Punch In/Out using a foot switch. You do not need to specify the Punch In/Out points. Instead, you press the foot switch at the Punch In/Out point. Manual Punch In/Out also offers rehearsal and actual takes. You can repeat rehearsal until you are ready. As an example, replace a part of the recorded guitar solo on track 3.

- Initialize the recorder.
- Select a desired Program for Punch In/Out.
- Check a sampling frequency of the recorder and external device.

### Preparation

Check to see that the guitar is connected to the input jack of the mixer, as required for [AUTO PUNCH IN/OUT] mentioned earlier.

- (1) **Connect the foot switch (unlatch type) to the [PUNCH IN/OUT] jack on the rear panel.**

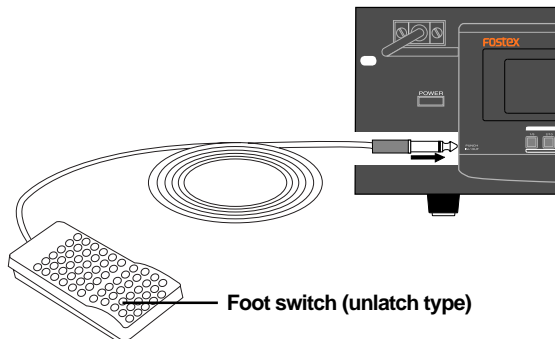

- (2) **Set the foot switch function to “Punch I/O” (punch in/out function) by the SETUP mode “Setup of the foot switch function” menu.**

### Rehearsing Manual Punch In/Out recording

In Rehearsal mode, the READY track enters input monitoring mode between the Punch In and Out points (the points at which you press the foot switch), and the sound is not recorded. You can practice the Punch In/Out operation repeatedly before you proceed to actual recording.

- (1) **Press the foot switch while holding down the [STOP] button.**  
“Rehearsal On” will appear on the display or about 1 second, then rehearsal mode will appear and the REHEARSAL LED (green) of the [AUTO PUNCH] key flashes.



- (2) **Press the [RECORD TRACK] select key [3/11/19] to set track 3 to READY.**
- (3) **Press the [PLAY] button to play back from a point slightly before the Punch In point.**

- (4) **Play the guitar accompanying the playback of tracks 1 to 8.**

The recording level and monitor volume is adjusted on the mixer in the same manner as done for [AUTO PUNCH IN/OUT] described earlier.

- (5) **Press the foot switch once at the desired Punch In point, then press the foot switch again at the desired Punch Out point.**

The rehearsal mode will operate as shown in the figure. Between the Punch In and Out points the current performance of the guitar will be played as the guitar monitor sound. The previous recording is heard in any other case. The RECORD LED lights up when Punching In and turn off when Punching Out (the REHEARSAL LED remains flashing).

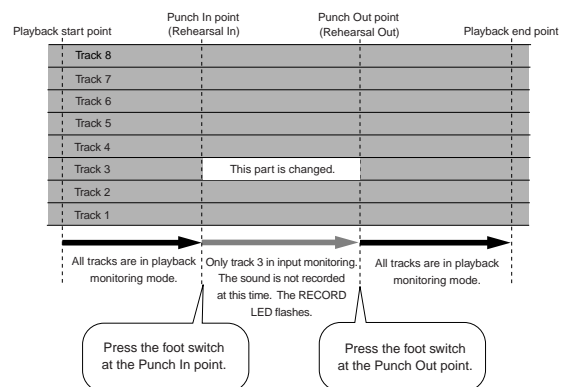

- (6) **When you finish rehearsing, press the [STOP] button.**

If you are still unsatisfied, repeat steps 3-5.

### Cancelling Rehearsal mode

- (1) **While holding down the [STOP] button, press the foot switch.**

The display shows “Rehearsal Off” for 1 second, then the flashing REHEARSAL LED turns off and cancels the rehearsal mode.

**<Hint>:** To rehearse repeatedly, set the AUTO RTN START point slightly before the Punch In point, and the AUTO RTN END point slightly before the Punch Out point. This will help you concentrate on your performance or check the recording level easily (especially since Manual Punch In/Out involves operating the foot switch operation as well as the recorder). (See <Hint-2> in the “Rehearsing Auto Punch In/Out recording” for more information.)



### Manual Punch In/Out take

You can proceed to record if you are satisfied with the recording level, foot switch timing, and rehearsal.

**<Note>**: You cannot record a second take during the Manual Punch In/Out operation without stopping the recorder. That is, the recorder will continue playing after you finish recording a take, but you cannot record another take by pressing the foot switch.

- (1) Confirm that Rehearsal mode is cancelled, and start playing the recorder from a point slightly before the desired Punch In point.
- (2) Play the guitar, accompanying the playback of tracks 1 to 8.
- (3) Press the foot switch at the desired Punch In point. Press the foot switch again at the desired Punch Out point.

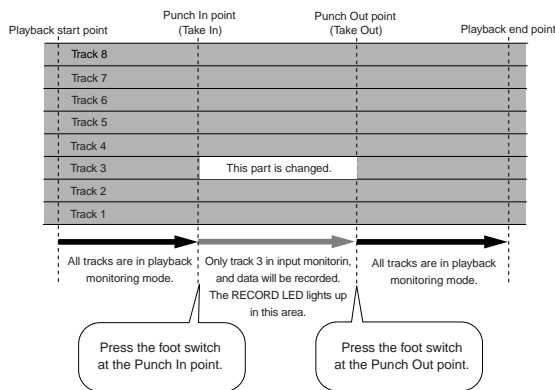

The recorder enters recording mode at the Punch In point, and cancels recording mode at the Punch Out point.

- (4) Press the [STOP] button.
- (5) Play track 3 and check the result of Punch In/Out.

#### <Caution after Punch Out>

In an FS=44.1kHz program, the simultaneously recordable number of tracks is a maximum of 8.  
 In an FS=88.2/96kHz program, the maximum is 2 tracks in which "seamless punch out" without mute can be executed.  
 In simultaneous recording beyond this number, the recorder will be muted for 3-5 seconds after punch out but during actual recording, it will be a seamless punch out. Depending on the speed of the hard disk being used, when recording a fewer number of simultaneous tracks than mentioned above, the recorder will also be muted, but this poses no problem during actual recording.

#### <Hint>

You can use the [PLAY] button and the [RECORD] button, instead of using the foot switch. Follow the steps below. This method also does not allow you to record another take unless you stop the recorder first. Procedure:

1. Press the [PLAY] button to start playback from a point slightly before the Punch In point.
  2. Press the [RECORD] button while holding down the [PLAY] button at the desired Punch In point. (Punch In recording starts.)
  3. Press the [PLAY] button at the desired Punch Out point. (Recording is punched out.)
- If you press only the [RECORD] button in both steps 2 and 3, you can rehearse Punch In/Out.

### Single Undo/Redo

You can single undo or redo Manual Punch In/Out recording.

Press the [UNDO/REDO] key after recording is complete to restore the conditions that existed prior to the recording.

Press the [UNDO/REDO] key again to restore the conditions that existed after the recording.

However, the procedures explained here is for Single Undo/Redo and there are limitations as written in the Notes below. If the current drive was formatted with the multiple undo function ON, Multiple Undo is also possible.

Refer to page "69" for details on the Multiple Undo function.

#### <Notes at executing single undo/redo>

**Note-1:** This function only works when this recorder is in the stop mode.

**Note-2:** After finishing manual punch in/out, please note that single Undo/Redo is not possible if the following have been executed.

- If a new recording has been made.
- When a new editing job is executed (such as Copy & Paste, Move & Paste, or Erase).
- When in the AUTO PUNCH ON mode, when the AUTO PUNCH IN point is passed in the PLAY (or RECORD) mode.
- If the power was switched off.
- If program select was executed.
- When multiple undo is executed.

# Recording Digital Data

## Digital recording from an external digital device

In addition to multirecording by connection to a digital mixer as explained in the separate “Quick Operation Guide” manual, the following explains the direct digital recording method by connection to external digital equipment (CD, MD, DAT, adat, etc.).

When recording digital signals from an external digital equipment, digital signals to be input to the **[DATA INPUT]** connector of the D2424LVmkII must be setup for “**S/P DIF**” (S/P DIF digital signals) or “**adat**” (adat digital signals) in the “Digital Input Setup” menu of the D2424LVmkII SETUP mode.

At the same time, the digital-in clock (Sync mode/async mode) should also be selected and setup for either sync with external digital signals or with the internal clock. Digital recording can be done on the currently active program, and “Setup for digital inputs” will be effective on all programs even when multiple number of programs are currently setup.

### • Connecting external digital equipment

- (1) **Interconnect the [DATA INPUT] connector of D2424LVmkII and [OPTICAL OUT] (or adat OUT) connector of the external digital equipment with an optical cable.**

Depending on the digital signal (S/P DIF or adat) to be recorded, the **[DATA INPUT]** connector will function as explained below.

#### <Notes on interconnecting>

When using the D2424LVmkII **[DATA INPUT]** connector, it must be set for either S/P DIF digital signals (optical) or adat digital signals via "Setup of digital inputs" in the SETUP mode. The connector type is the same for S/P DIF digital signals and adat digital signals but information content of the digital signal is different. Also, depending on the selected digital signal, each **[DATA INPUT]** connector will function as explained below.

#### <When recording S/P DIF digital signals>

**[DATA INPUT] 1-8** only can be used.

By setting the SETUP mode “Setup of digital inputs” to “**SPDIF: Async**” or “**SPDIF: sync**,” S/P DIF digital signals that are input to **[DATA INPUT] 1-8** will be assigned to tracks 1 and 2 of the D2424LVmkII.

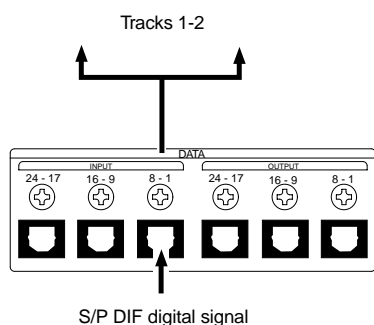

#### <When recording adat digital signals>

**[DATA INPUT] 1-8, 9-16, 17-24** can all be used.

By setting the SETUP mode “Setup of digital inputs” to “**adat: Async**” or “**adat: Sync**,” adat digital signals input to each input connector will be assigned to each track of the D2424LVmkII.

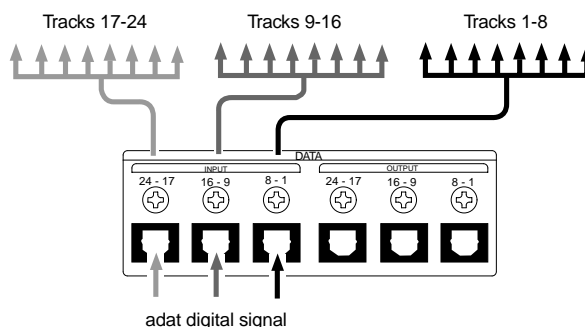

**<Important!>** Be sure to input a digital signal (S/PDIF or adat) of the same sampling frequency as that used on the recorder.

**<Note>**: The **[DATA INPUT]** connectors of the unit does not support 96kHz FS adat digital signals.

\* If the connected external device has only a COAXIAL (RCA pin) jack for digital output, use an optional Fostex COP-1/96k (optical/coaxial converter).



## • Selecting a recording Program

- (2) If you already have multiple Programs, select the desired Program using the Program Select function.

\* See page "40" for more information on the Program Select function.

## • Setting the digital input

- (3) Set up the digital signal to be input and the digital in clock at the setup mode "Setup of digital inputs" menu.

The setting of digital input is initially set to "Analog" and digital signals cannot be input.

In order to record external digital signals, "SP DIF: Async," "SP DIF: Sync," "adat: Async" or "adat: Sync" should be setup in accordance to the purpose.

### "SPDIF:Async":

S/P DIF digital signals from [DATA INPUT] 1-8 will be assigned to tracks 1 and 2, and the digital equipment is synchronized with the internal clock of the D2424LVmkII.

### "SPDIF:Sync":

S/P DIF digital signals from [DATA INPUT] 1-8 will be assigned to tracks 1 and 2, and will be synchronized with the S/P DIF digital signals from the external digital equipment.

### "adat:Async"

adat digital signals from [DATA INPUT] 1-8, 9-16 and 17-24 will be assigned to tracks 1-8, 9-16 and 17-24 respectively, and the digital equipment synchronized with the internal clock of D2424LVmkII.

### "adat:Sync"

adat digital signals from [DATA INPUT] 1-8, 9-16 and 17-24 will be assigned to tracks 1-8, 9-16 and 17-24 respectively, and synchronized with the adat digital signals from the external digital equipment.

\* Refer to page "117" for setup of "D.in?" menu.

If digital input is set to "Analog," "SPDIF: Async" or "adat: Async," the SETUP mode "Clock Sel?" (setup of operating clock) must be set up.

**<Note>**: When the "Setup of digital inputs" is set to sync mode of "SPDIF: sync" or "adat: Sync", the SETUP mode "Clock Sel?" setting will be ignored and the digital-in clock will have priority. In this case, "DIGITAL" and "EXT" will light up in the "CLOCK" section of the display.

## <Notes>

- Do not connect or disconnect the optical cable to the [DATA INPUT] connector when digital input is assigned. Doing so could generate noise in the D2424LVmkII and affect the external digital equipment.
- When the digital input is set to "adat" (Async or Sync) and locked to any one among the three [DATA INPUT] (1-8, 9-16, 17-24), "DIGITAL" will light in the display, and the tracks not locked will automatically change to analog input. By using this function, analog/digital 24 track simultaneous recording will be possible by applying analog signals to tracks 1-8 and adat digital signals to tracks 9-16 and 17-24.

## • Setting recording tracks

- (4) Press the [RECORD TRACK] select keys of the tracks selected in the digital input track menu to ready the tracks for recording.

## • Recording

- (5) Locate the beginning of the Program.
- (6) Make sure that the "DIGITAL" indicators light up on the screen. While pressing and holding down the [RECORD] button, press the [PLAY] button to start recording.
- (7) Play the external digital device. Make sure that the level meter segments light up and move as the digital signal is being input.

## • Completing recording

- (8) After you finish recording, stop the recorder and the connected digital equipment.

### <Hint!>

When a "Digital 0 (zero)" signal is input during digital recording under the SETUP mode "Zero File?" menu, whether or not a "0 file" should be recorded or not can be setup. Although the "Zero File?" menu is initially set to "Enable," by changing this to "Disable," a "0 file" will not be registered and the digital signal to be recorded can be made as "one file." For details on the "Zero File?" menu, refer to page "127."

[Clock Sel ?] setting		Int	Auto	Word	Video
[D. in ?] setting					
SPDIF :Async adat :Async	clock received from WORD IN	Regardless of receiving or not receiving word clock from WORD IN, the recorder is referenced to the internal clock. When the recorder receives correct digital signals, the "DIGITAL" indicator lights in the display.	When receiving word clock from WORD IN, the recorder automatically synchronizes to the incoming clock, while the "DIGITAL" and "EXT" indicators light in the display.	When receiving word clock from WORD IN, the recorder synchronizes to the incoming clock, while the "DIGITAL" and "EXT" indicators light in the display.	Available only when installing the optional Model 8346 TC/SYNC card. If you try to select "Video," "Void w/ o 8346" is displayed and you cannot select it. See the appendix of the Reference manual for details.
	no clock received from WORD IN		When no word clock is received, the recorder is referenced to the internal clock, while the "EXT" indicator flashes.	When no word clock is received, the "EXT" indicator flashes showing that the unit cannot be locked.	
SPDIF :Sync adat :Sync	clock received from WORD IN	Regardless of receiving or not receiving word clock from WORD IN, the recorder synchronizes to the external S/P DIF digital signal. When the recorder receives correct digital signals, the "DIGITAL" and "EXT" indicators light in the display. When Digital In is set to a SYNC mode, if you try to select "Clock Sel?" menu, The display will show "Clock Sel D.in!" (indicating that the clock is set to Digital In!) and the recorder ignores your operation.			
	no clock received from WORD IN				

**Digital recording to external digital equipment**

Tunes recorded on the D2424LVmkII can be recorded on external digital equipment such as MD, DAT, CD-R or adat. In order to digital record to external digital equipment, digital signals to be output at the D2424LVmkII [DATA OUTPUT] connector must be set to "SP DIF" or "adat" (The initial setup is "adat.") by the "Setup of digital output" menu in the D2424LVmkII SETUP mode. The currently active program can be digitally recorded and "Setup of digital outputs" will be common to all programs.

**• Connecting external digital equipment**

- (1) Use an optical cable to connect the [DATA OUTPUT] connector of the recorder to the OPTICAL IN (or adat IN) jack of the external digital equipment.

Set the external equipment input port to "digital" so that digital signals can be input. Because some digital equipment must be externally synchronized against digital signals, in addition to setting the input port to "digital," be sure to refer to the operating manual of any digital equipment to be used. Depending on the digital signal that is output, the [DATA OUTPUT] connector will function as explained below.

**<Notes on interconnecting>**

[DATA OUTPUT] of the D2424LVmkII must be setup for S/P DIF digital signals (optical) or adat digital signals by the "Setup of digital output" menu in the SETUP mode. Although the connector type is same for both S/P DIF digital and adat digital signals, their information content is different. Depending on the digital signal selected, the following signals are output from each output connector.

**<At output of S/P DIF digital signals>**

**<At output of adat digital signals>**

**<Important!>**: Be sure to output a digital signal (S/PDIF or adat) of the same sampling frequency as that used on the recorder.

**<Note>**: The [DATA OUTPUT] connectors of the unit does not support 96kHz FS adat digital signals.

**<Notes>**

- Connecting the recorder to an external digital device via both digital input and output jacks may generate a digital loop.
- Data on the additional tracks cannot be digitally recorded to the external device as it is. To output digital data from the additional track, move it to the real tracks first, then output it to the external device (using the Track Exchange function). For more information on the Track Exchange function, see page “77.”

\* If the connected external device has only a COAXIAL (RCA pin) jack for digital input, use an optional Foxtex COP-1/96k (optical/coaxial converter).

**• Selecting a recording Program**

- (2) If you already have multiple Programs, select the desired Program using the Program Select function.

\* See page “40” for more information on the Program Select function.

**• Setting the digital output**

Use the digital output setup menu in Setup mode to assign output tracks. With the default setting, the digital output is set to “**adat**”. You can select “**adat**” or “**SP DIF**”. To output adat digital signals to a connected adat device, select “**adat**.” To output S/P DIF signals to a connected CD-R, MD, or DAT recorder, select “**SP DIF**.”

\* See page “118” for more information on the “D. out?” menu.

When you finish setting the parameters in Setup mode, press the [EXIT/NO] key or the [STOP] button to exit Setup mode.

**Connecting a Digital Mixer**

The following explanations assume that this is digital mixer, which can input digital signals whose clock source can be setup at digital in.

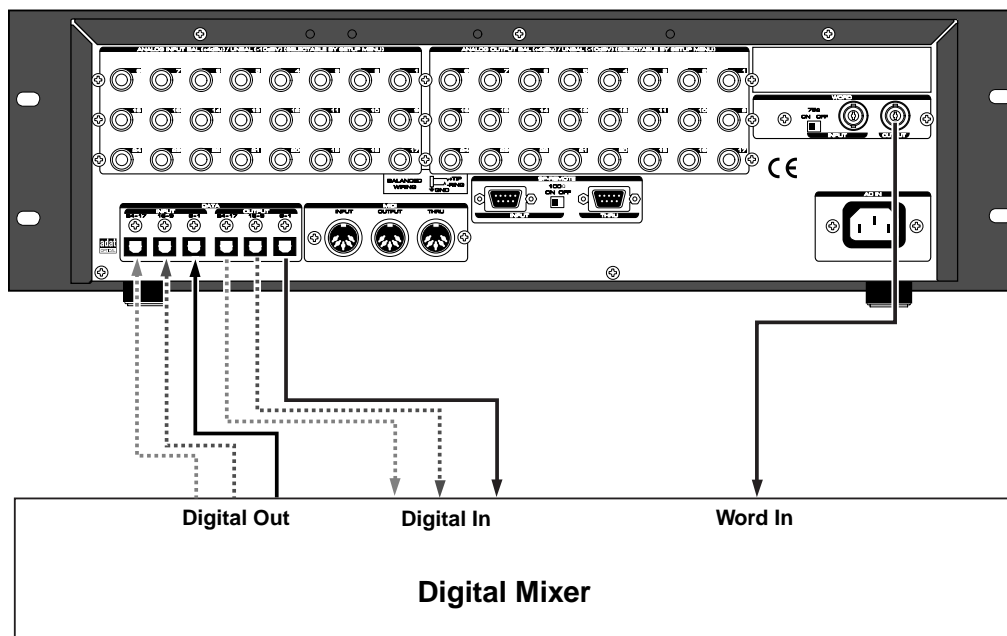

**<Precaution against the digital loop>**

When interconnecting D2424LVmkII and a digital mixer as shown in above schematic, if the D2424LVmkII “**Setup of the digital input**” is set to **adat** or “**Sync**” (synchronous mode) of S/P DIF, and the digital mixer clock source is set to “**DIGITAL IN**,” a digital loop will be created and it will not operate correctly.

In such a case, setup the D2424LVmkII “**Setup of the digital input**” to **adat** or “**Async**” (asynchronous mode) of S/P DIF.

# Recording to a Metronome Sound

This chapter explains how to record your performance while you are playing an instrument accompanied by a metronome based on the time signature and tempo specified in the Tempo Map. The metronome sound is output from track 24 on the D2424LVmkII.

- Initialize the recorder before the operation.
- If multiple Programs exist, first select the desired Program.

**<Notes>**

- \* With the metronome function ON and the RECORD TRACK select key for the track (track 24) to which the metronome sound is to be output set to READY, an attempt to record you cannot record to this track. Also, information which had already been recorded on this track cannot be played back.
- \* Always switch off the Metronome function setting in the SETUP mode after finishing.

**<Please remember this!>**

In D2424LVmkII which had been formatted to 96kHz/24bit or 88.2kHz/24bit (Real track 1-8) the metronome sound will be output from track 24. Therefore, Real tracks 1-8 can all be used for normal recording/playback.

## Preparation

### • Creating a Tempo Map

- (1) **Set the time signature using the “Setting a time signature” menu in SETUP mode.**  
Refer to the “Setting a time signature” section on page “110.”
- (2) **Set a tempo for a given point using the “Setting a tempo” in SETUP mode.**  
Refer to the “Setting a tempo” section on page “112.”

### • Turning the Metronome function on

- (3) **Turn the Metronome function on using the “Setting the Metronome function” menu in SETUP mode.**  
Refer to the “Setting the Metronome function” section on page “113.”

## Recording to a metronome sound

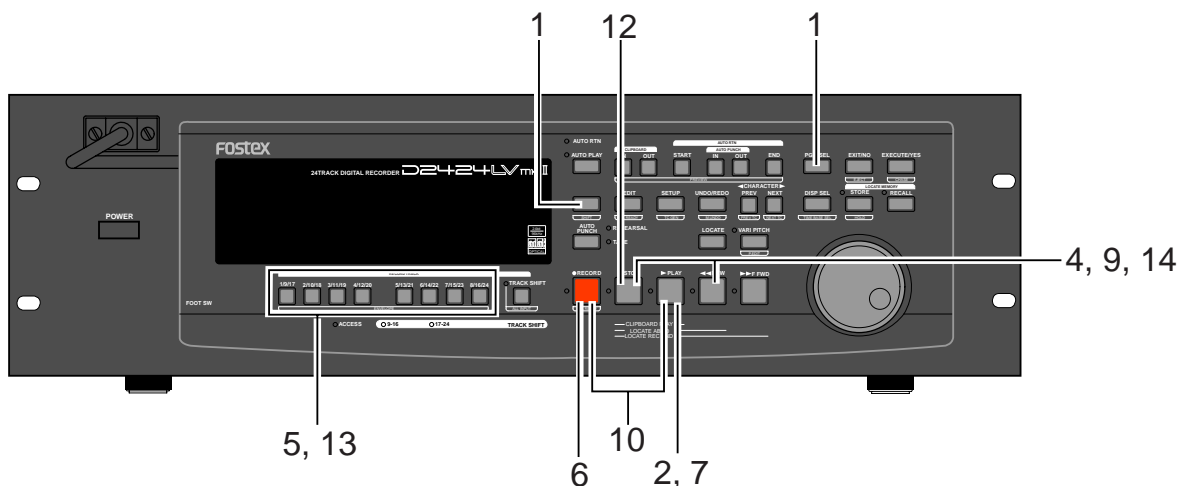

### • Checking the metronome sound

---

- (1) **Press the [DISP SEL] key while holding down the [SHIFT] key to switch the time base in advance to BAR/BEAT/CLK.**
- (2) **Start playback from the beginning of the Program.**  
Even if the selected Program does not have any recorded data, track 24 outputs the metronome sound and the unit counts time.
- (3) **Adjust the system so the sound output from track 24 can be monitored with the mixer.**  
You will hear the metronome sound output from track 24 using the Tempo Map created earlier.
- (4) **After confirming the metronome sound, stop the recorder section and return to the top Program.**

### • Checking the recorded sound

---

- (13) **Turn OFF the ready track [RECORD TRACK] select key .**
- (14) **Locate the top of the Program and start playback.**  
Adjust and monitor the track playback sound recorded on the mixer.  
Since the metronome function still remains ON at this time, you can hear the metronome sound during playback of the recorded sounds when you turn up the track 24 monitor volume.

• *If you wish to redo the recording, repeat the recording after executing “undo” by using the single undo/redo or multiple undo functions.*

### • Adjusting monitor/record level of the musical instrument

---

- (5) **Press the [RECORD TRACK] select key of the track to record the musical instrument on, and then put that track in the READY mode.**
- (6) **Press the [RECORD] button.**  
The LED of the [RECORD] button will flash and the READY track will go to the input monitor mode.
- (7) **Press the [PLAY] button and playback the Program from the top.**  
Only the READY track will go to the input monitor mode (recording does not take place), and all other tracks will be in the reproduction monitor mode, therefore track 24 plays back the metronome sound.
- (8) **Play the musical instrument in time with the metronome and adjust the recording level of the track to be recorded on the mixer.**
- (9) **After adjusting the recording level, stop the recorder and return to the top of the Program.**

### • Starting recording

---

- (10) **Hold down the [RECORD] button and press the [PLAY] button to start recording.**  
The READY track will go to the input monitor mode just as when the recording level was adjusted. The time the level that was actually adjusted with the mixer will be recorded.
- (11) **Play the musical instrument in time with the metronome.**

### • Quitting recording

---

- (12) **Press the [STOP] button to stop the recorder.**

# Storing a Locate Point (Edit Point)

You can store specific individual time data (time, bar/beat/clock) in each memory key (\*). The time data stored is used as an “**Editing Point**” to execute “**Locate Point**” or Auto Punch In/Out, Copy & Paste, Move & Paste or Erase. You can also store 99 (Locate Number 01-99) time data in the **[LOCATE]** key, in addition to the **Memory key**, to enable locate only features. This chapter will describe how to store specific data in the memory key and how to edit and re-store data is already stored in the memory key. The data stored in each memory are used for the following operations. Also, the 99 locate memories can be used for the Mark STOP memory. For details, refer to "Setup of stop function at the mark point" in the SETUP mode.

## \* Memory key

When you set the IN/OUT points for Auto Punch In/Out, IN/OUT points for Copy & Clip/Move & Clip, and START/END points for Auto Return/Auto Repeat, END points.

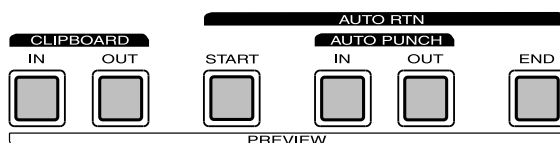

<b>[AUTO PUNCH IN] key</b>	<ul style="list-style-type: none"> <li>• Locating the AUTO PUNCH IN point.</li> <li>• Recording start point for the Auto Punch In/Out operation.</li> <li>• Paste start point for the Copy &amp; Paste or Move &amp; Paste operation.</li> <li>• Erase start point for the Erase operation.</li> </ul>
<b>[AUTO PUNCH OUT] key</b>	<ul style="list-style-type: none"> <li>• Locating the AUTO PUNCH OUT point.</li> <li>• Recording end point for the Auto Punch In/Out operation.</li> <li>• Erase end point for the Erase operation.</li> </ul>
<b>[CLIPBOARD IN] key</b>	<ul style="list-style-type: none"> <li>• Locating the CLIPBOARD IN point.</li> <li>• Copy start point for copying or moving data to the clipboard during the Copy &amp; Paste or Move &amp; Paste operation.</li> </ul>
<b>[CLIPBOARD OUT] key</b>	<ul style="list-style-type: none"> <li>• Locating the CLIPBOARD OUT point.</li> <li>• Copy end point for copying or moving data to the clipboard during the Copy &amp; Paste or Move &amp; Paste operation.</li> </ul>
<b>[AUTO RTN START] key</b>	<ul style="list-style-type: none"> <li>• Locating the AUTO RTN START point.</li> <li>• Locate end point from AUTO RTN END in Auto Return or Auto Repeat modes.</li> </ul>
<b>[AUTO RTN END] key</b>	<ul style="list-style-type: none"> <li>• Locating the AUTO RTN END point.</li> <li>• Locate start point to AUTO RTN START in Auto Return or Auto Repeat modes.</li> </ul>

### <Note on storing the locate point>

When you set the IN/OUT points for Auto Punch In/Out, IN/OUT points for Copy & Clip/Move & Clip, and START/END points for Auto Return/Auto Repeat, make sure that IN points precede the OUT points and START points precede the END points.

You can also store time data in the **[LOCATE]** key, in addition to each memory key explained above. You can store up to 99 individual time data in the **[LOCATE]** key for locate only features. Store the data by specifying Locate Number to locate the intended time data. Note that the **[LOCATE]** key always stores the last located time data in real-time. This Locate Number is stored as 00, and does not require a Locate Number specification to locate it.

Simply pressing the **[LOCATE]** key directly, will locate that data. This becomes an advantage since it is possible to repeatedly locate the last located point.

You can edit the data stored in the **[LOCATE]** key, as so with the data stored in the Memory key. For more details refer to page “56.”

- You can store locate points for each Program. (You need to select a Program first.)
- When executing save/load of song data via the compactFlash™ card (or an optional E-IDE hard disk drive), these data can be directly saved/loaded. Save/load by DAT and adat cannot be done.
- All locate points stored in the memory keys will be maintained after you turn off the recorder.

## Storing and editing the locate points to the memory keys

- Select the desired Time Base using the **[DISP SEL]** key and **[SHIFT]** key an if you wish to use a Time Base other ABS.
- The stored or edited locate points are used only in the currently-selected Program.

### Storing in real-time

You can store the locate point (in the ABS, MTC, or BAR/BEAT/CLK Time Base) in real-time while the recorder is playing.

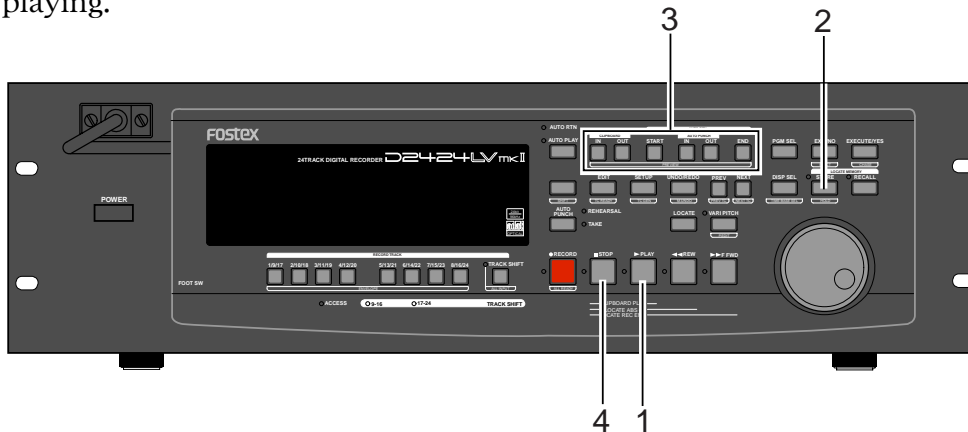

- (1) Press the **[PLAY]** button to play back data.
- (2) When the point you wish to store is reached, press the **[STORE]** key.  
The time value or bar/beat/clock value of the point is captured. The recorder enters data edit mode.
- (3) Press the desired memory key.  
The STORE LED turns off.  
The captured time value (or bar/beat/clock value) is stored in the memory key. After the data is stored, the recorder displays the previous Time Base and continues playback.
- (4) Press the **[STOP]** button.

**<Note>**: The following menu (##=number from 00-99) appears when pressing the **[STORE]** key. This menu is used to store data in the **[LOCATE]** key, described later. Ignore this menu and go to the next step when storing data in the memory key.

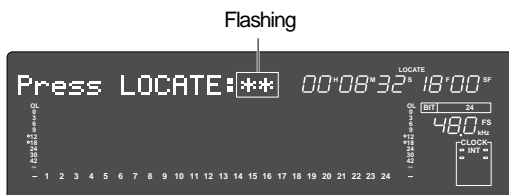

#### <Please remember this!>

- If you set “BAR/BEAT Resolution mode” in SETUP mode to ON, the recorder will round off the CLK value of the captured bar/beat/clock value. That is, the locate point will be at the beginning of the beat (00). Refer to page “119” for more information.
- When pressing the **[STORE]** key in step 2, if the **[STORE]** key is pressed while holding down the **[SHIFT]** key, data to be registered will be held and be confirmed. To register data after confirmation, press the **[STORE]** key again and press the desired memory key.

### Editing and storing data

You can recall data stored in the memory key, edit it, and store it again.

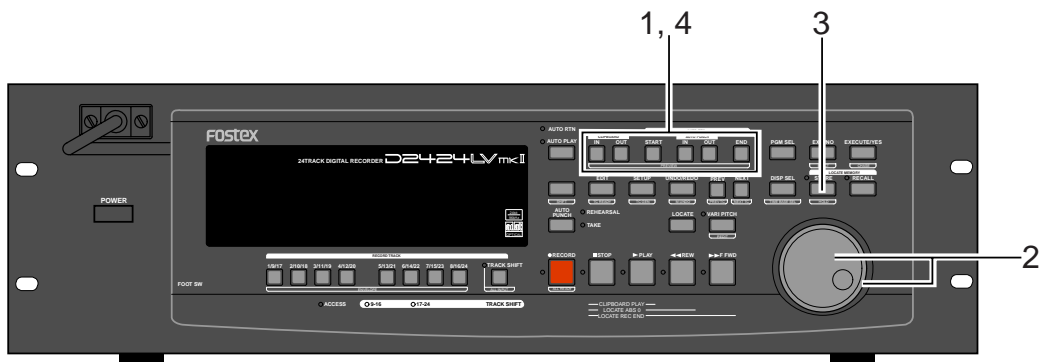

- (1) **While the recorder is stopped, press the memory key that stores the data you wish to edit.**  
The stored data appears on the display and the recorder enters data edit mode.
- (2) **Turn the Shuttle dial to move the flashing cursor to the time value digit, and use the Jog dial to increase or decrease the value.**
- (3) **Press the [STORE] key.**  
The "Press LOCATE: ##" menu will appear as indicated before. Ignore this go to the next step.
- (4) **Press the memory key that you pressed in Step 1 again.**  
The STORE LED will turn off. The edited data is stored, and the recorder displays the previous Time Base indication.

- You can store the edited data in a memory key other than the one you pressed when you recalled the data. For example, you can recall the AUTO PUNCH IN point data, edit it, and store it to the [AUTO PUNCH OUT] key.
- You can also use the Preview function to edit the stored locate points (edit points). Refer to "Preview Function" on page "67" for more information.

- Refer to page "43" for more information on Auto Punch In/Out.
- Refer to page "71" for more information on Copy & Paste, Move & Paste, and Erase.
- Refer to page "58" for more information on Auto Return and Auto Repeat.

### Storing and editing [LOCATE] key

You can store up to 99 individual time data in the [LOCATE] key for Locate only operations. The time data stored can also be assigned with a specific locate number from 01-99. This means the desired locate number can be specified to locate that specific time data.

The memory data of the [LOCATE] key can also be edited in the same manner as the data in the Memory key. After editing the data the [LOCATE] key can locate that point, or even be re-stored as data for other Memory keys.

- <Notes>**
- The last data located with the Memory key or [LOCATE] key is constantly stored as LOCATE number 00. However, this data is constantly replaced after every LOCATE command. Therefore, do not use Locate Number 00 for independent Locate data.
  - You cannot preview the data stored in the [LOCATE] key, though it is possible to preview data stored in other Memory keys.

- \* If you use a time base that is not an ABS time, there is a need to priory switch to the desired time base using the [SHIFT] key and [DISP SEL] key.
- \* Any editing or storing of data for the LOCATE point is valid only for the program that is currently started up.

### Storing in real-time

You can store the locate point (in the ABS, MTC, or BAR/BEAT/CLK Time Base) in real-time while the recorder is playing.

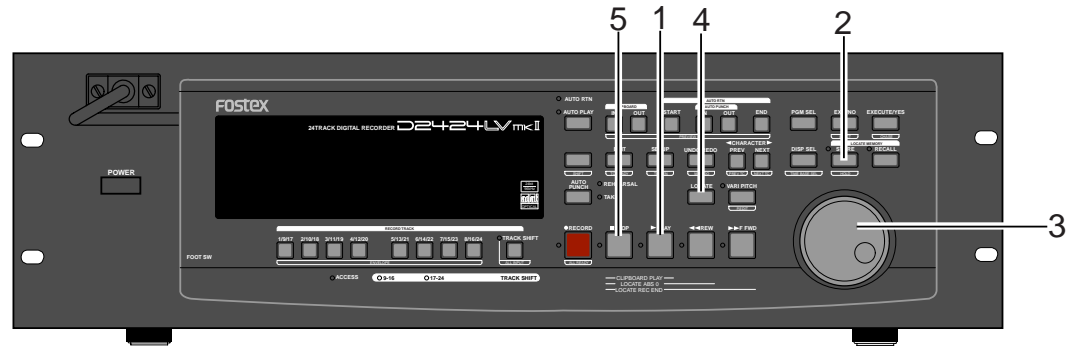

- (1) **Press the [PLAY] button to start playback.**
- (2) **Press the [STORE] key (the STORE LED lights up).**  
The memory number selection menu will appear, as follows.

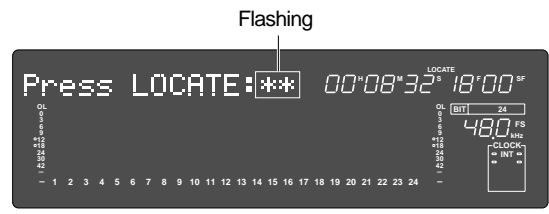



- (3) **Select the LOCATE number desired using the Jog dial.**  
LOCATE number from 00-99 are selectable. However, select a number other than 00.
- (4) **Next press the [LOCATE] key.**  
The time base (or bar/beat/clock) put on hold is stored as data in the LOCATE number selected. The system will return to the original time base when the storage process is completed, and playback is resumed.
- (5) **After completing the store process, press the [STOP] button to stop the recorder section.**

**<Please remember this!>**

- If you set “BAR/BEAT Resolution mode” in SETUP mode to ON, the recorder will round off the CLK value of the captured bar/beat/clock value. That is, the locate point will be at the beginning of the beat (00). Refer to page “119” for more information.
- When pressing the [STORE] key in step 2, if the [STORE] key is pressed while holding down the [SHIFT] key, data to be registered will be held and be confirmed. To register data after confirmation, press the [STORE] key again and press the desired memory key.

### Edit and re-store data that is already stored

RECALL the desired time data already stored in the [LOCATE] key, edit that data and re-store it.

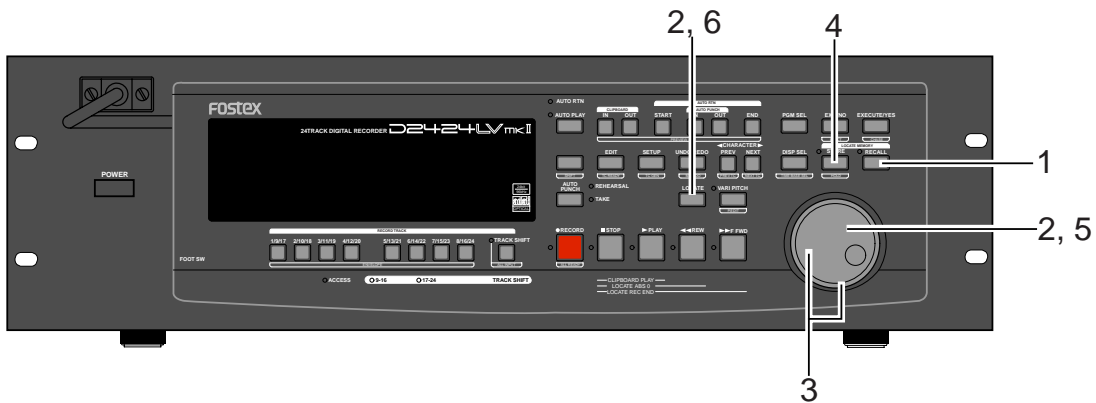

- (1) **Press the [RECALL] key while the recorder is stopped.**  
The menu to select the LOCATE number will appear.

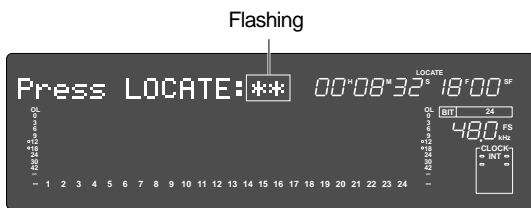

- (4) **Press the [STORE] key (the STORE LED lights up).**  
The LOCATE number selection menu to store data will appear.

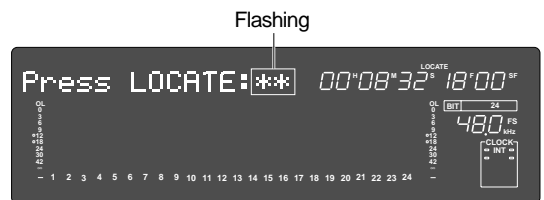

- (2) **Turn the Jog dial to select the desired LOCATE number, then press the [LOCATE] key.**  
The data edit mode will appear when the data stored in the selected LOCATE number appears.

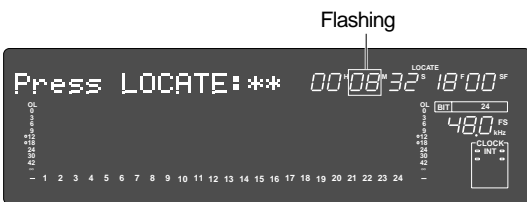

- If the [STORE] key is press instead of the [LOCATE] key at this stage, it becomes possible to directly LOCATE the time data of the selected LOCATE number. For more details refer to the next section on “Locate Functions.”

- (3) **Turn the Shuttle dial to move the (cursor) column of the time indication to edit (cursor flashing point), increase or decrease the number setting with the Jog dial or input the desired time base.**

- (5) **You can use the Jog dial to input the desired LOCATE number.**
- (6) **Press the [LOCATE] key.**  
The edit time data is stored as the time data for the selected LOCATE number.

# Locate Function

The recorder swiftly locates (it moves the current location of the recorder section) the desired point when necessary. Locate include edit points (in ABS time, MTC time, or in bar/beat/clock) that are stored for the Copy, Move, Paste, Erase, or Auto Punch In/Out operations. They also include Locate by specifying a voluntary time, and Locate specifying a voluntary Locate Number (01-99), as well as Locate directly to the recording end point in a Program (REC END). An application of the Locate function includes auto functions such as Auto Play, Auto Return and Auto Repeat.

## Direct Locate

The Direct Locate function enables you to locate the following points:

### • Locate the beginning of the Program (LOCATE ABS 0)

Press the [REWIND] button while holding down the [STOP] button.

The recorder will immediately locate the beginning of the currently-selected Program.

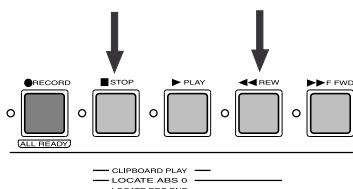

### • Locate the recording end point of the Program (LOCATE REC END)

Press the [F FWD] button while holding down the [STOP] button.

The recorder will immediately locate the end point of the currently-selected Program.

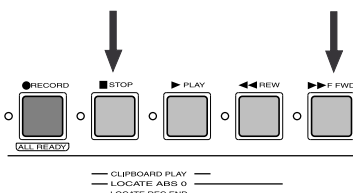

### • Locate the position stored in one of the memory keys

Press the desired memory key, then press the [LOCATE] key.

The recorder will locate the point (edit point) stored in the corresponding memory key immediately.

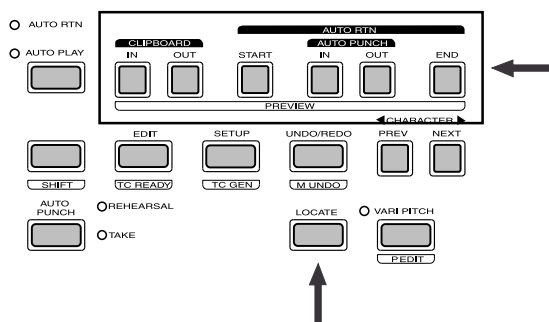

The located time data is always stored as time data in Locate Number 00.

### • Specify the Locate Number to locate data

1. Press the [RECALL] key.

The Locate Number selection menu appears.

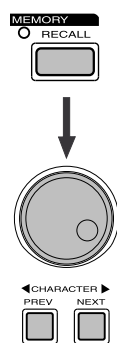

2. Turn the Jog dial or press the [NEXT] key / [PREV] key to select the desired number.

3. Press the [LOCATE] key once.

The time stored in the selected Locate Number appears.

4. Press the [LOCATE] key again.

The time data of the selected LOCATE number is swiftly located. The located time data is constantly stored as time data in Locate Number 00.

### • Locate a specified point

Refer to “Editing and storing locate data” in the chapter “Storing a Locate Point (Edit Point)” for information on how to edit the data and on pressing the [LOCATE] key instead of the [STORE] key.

The point at specified time value (or bar/beat/clock value) will be located immediately.

### • Locate the last-located point

Directly press the [LOCATE] key.

The time data of Locate number 00 is located. Locate number 00 is always update with the last data located (excluding LOCATE ABS 0 and LOCATE REC END). Therefore, you will locate the data in memory number 00 every time you directly press the [LOCATE] key.



## Auto Play function

The Auto Play function allows the recorder to start play back automatically from the located point. AUTO PLAY mode should be turned on before you execute the Direct Locate function described above.

**<Notes>**

- This function is effective within 24 ABS hours. Therefore, if playback continues over the recording end point, the recorder will still continue counting the time. Also, when the recorder locates ABS REC END, it will continue counting the time from the recording end point. (However, the unit does not access the disk after reaching the recording end point.)
- If the "Chain Play?" menu in the SETUP mode is set other than "Off," ON/OFF of AUTO PLAY cannot be executed.

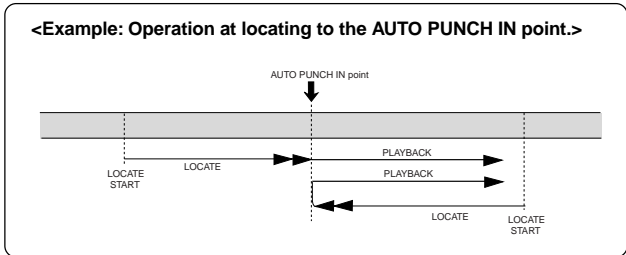

- (1) Press the [AUTO RTN/AUTO PLAY] key to turn on the [AUTO PLAY] LED.

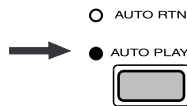

- (2) Press the [LOCATE] key, or memory key.  
The recorder locates the point and plays as shown in the diagram.

- (3) Press the [STOP] button to stop the unit.

• You can set a preroll time in the "Preroll Time?" menu in SETUP mode so that the recorder will start playback preroll time before the locate point. You can set the preroll time from 0 to 10 seconds. Refer to the chapter "Changing the Initial Settings (SETUP Mode)" on page "113."

## Auto Return function

This function allows the recorder to play data up to the AUTO RTN END point, then automatically locate the AUTO RTN START point as shown in the diagram below. To enable this function, AUTO RTN mode should be on and the AUTO RTN START point and AUTO RTN END point should already be set.

**<Note>**: If the "Chain Play?" menu in the SETUP mode is set other than "Off," ON/OFF of AUTO RETURN cannot be executed.

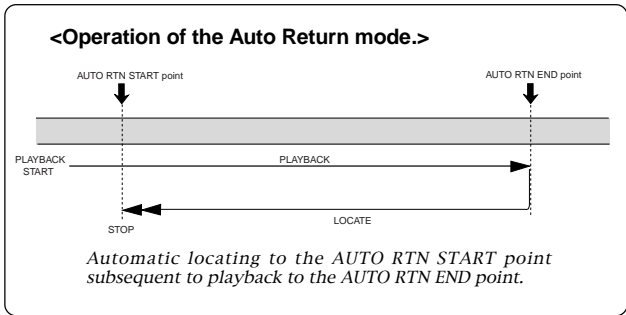

- (1) Store the AUTO RTN START and AUTO RTN END points.  
Refer to the chapter "Storing a Locate Point (Edit Point)" on page "54" for information on storing the desired points in the [AUTO RTN START] key and the [AUTO RTN END] key.

- (2) Press the [AUTO RTN/AUTO PLAY] key to turn on the [AUTO RTN] LED.

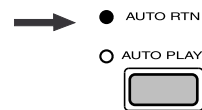

- (3) Start playback a little before the AUTO RTN END point.  
The recorder operates as shown in the diagram.

• You can set a preroll time in the "Preroll Time?" menu in SETUP mode so that the recorder will start playback preroll time before the locate point. You can set the preroll time from 0 to 10 seconds. Refer to the chapter "Changing the Initial Settings (SETUP Mode)" on page "113."

### Auto Repeat function

The Auto Repeat function allows the recorder to repeat playback up to the AUTO RTN END point, automatically locate the AUTO RTN START point, then play up to the AUTO RTN END point until you cancel the function by pressing the STOP button. To enable this function, both AUTO PLAY mode and AUTO RTN mode should be turned on, and the AUTO RTN START point and the AUTO RTN END point should already be set.

Using this function will facilitate the Auto Punch In/Out and Manual Punch In/Out rehearsal. See “**Hint!**” after the following section.

**<Note>**

If the “Chain Play?” menu in the SETUP mode is set other than “Off,” ON/OFF of AUTO REPEAT cannot be executed.

**<Operation of the Auto Repeat mode.>**

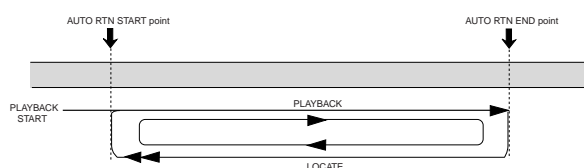

- (1) **Store the AUTO RTN START and AUTO RTN END points.**  
Refer to the chapter “Storing a Locate Point (Edit Point)” on page “54” for information on storing the desired points in the [AUTO RTN START] key and the [AUTO RTN END] key.

- (2) **Press the [AUTO RTN/AUTO PLAY] key to turn on the [PLAY RTN], [AUTO PLAY] LEDs.**

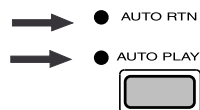

- (3) **Start playback a little before the AUTO RTN START point.**  
The recorder operates as shown in the diagram, and stops at the AUTO RTN START point.

- You can set a preroll time in the “Preroll Time?” menu in SETUP mode so that the recorder will start playback preroll time before the locate point. You can set the preroll time from 0 to 10 seconds. Refer to the chapter “Changing the Initial Settings (SETUP Mode)” on page “113.”

**<Hint!>**

You can make repeated Auto Punch In/Out rehearsal much easier and quicker by using the Auto Repeat function.

Set the AUTO RTN START point prior to the AUTO PUNCH IN point, and set the AUTO RTN END point after the AUTO PUNCH OUT point. The recorder will repeat the operation automatically so you can concentrate on your rehearsal. Cancel Auto Repeat mode before you record a take.

The recorder will play this range repeatedly for rehearsal, which makes it easy for you to check the recording level and practice your performance.

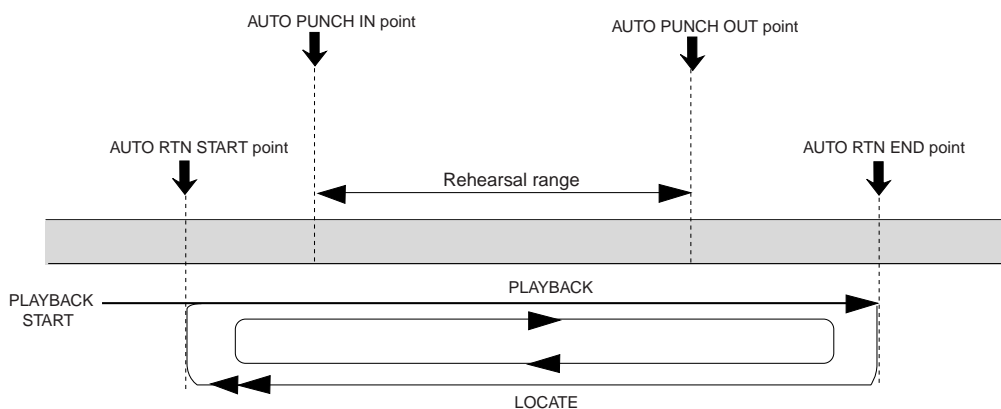

# Chain Play function

“Chain play” functions to playback, in any order, the tunes recorded on a multiple number of programs. There are three modes of chain play and each operates as shown below. Before executing these modes, “AUTO RTN START point” and “AUTO RTN END point” must be set for each program. For details, please read the explanations starting from the next page.

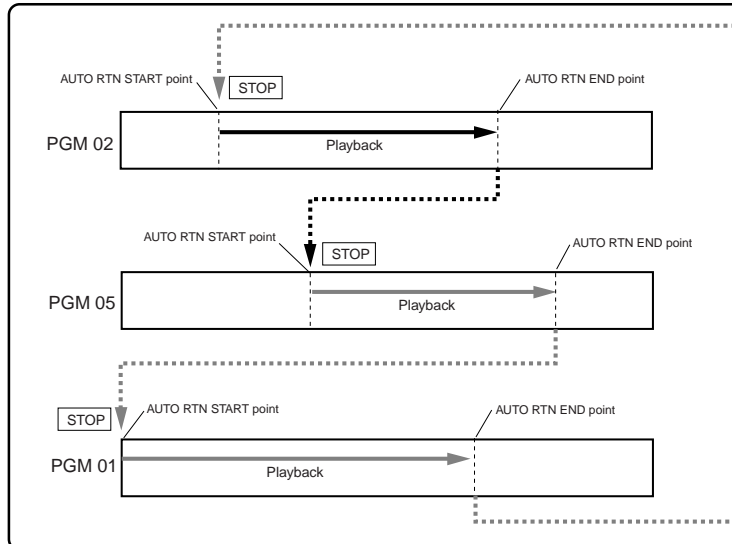

## <Pause mode>

In the pause mode, as shown in the example on the left, upon reaching the “END point” at playback of program **02**, the recorder automatically stops at the “START point” of program **05** which is to be played back next.

If chain play is executed again at the stopped point, it will stop again at the next program **10** “START point.”

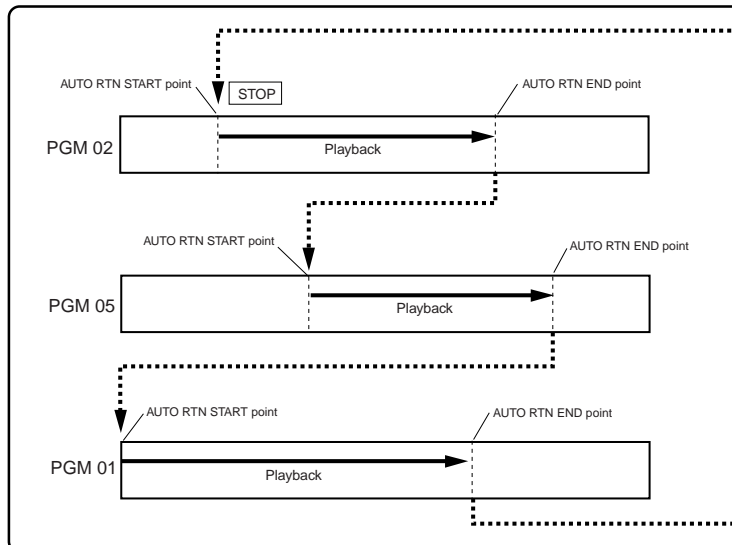

## <Auto Play mode>

In the auto play mode, as shown in the example on the left, upon reaching the “END point” of program **02** started in playback, the recorder will automatically playback in setup order between the “START points - END points,” and, at the moment playback is finished at the “END point” of the last program **01**, stops at the “START point” of the first program.

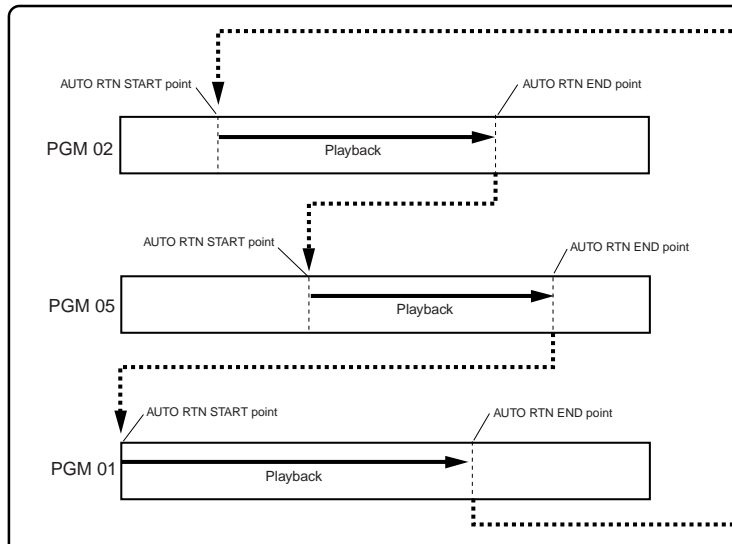

## <Repeat mode>

In the repeat mode, playback is repeated until the above auto play mode is canceled.

**<Note>**: If power is switched off and then switched on again while set to the Repeat mode, playback will automatically start from the first program.

**Setup of the Chain Play List**

The chain play list is setup via the “Chain Play List?” menu in the SETUP mode. The following procedure is based on the assumption that a multiple number of programs are in the current drive and that a tune is recorded in each program.

- (1) Enter the SETUP mode by pressing the [SETUP] key while the D2424LVmkII is in the stop mode.
- (2) Use the Jog dial to display the “Chain Play List?,” and then press the [EXECUTE/YES] key. The display will change to setup of the play list.

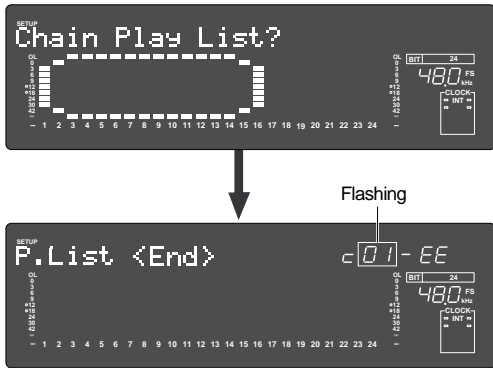

This display indicates the initial setting in which no chain list is setup (“EE” means “invalid.”). The chain play number can be set in the currently blinking section (left) and numbers “01” through “99” can be input via the Jog dial. Also, the flashing section can be moved from the left “01” to the right “EE” by pressing the [EXECUTE/YES] key, and except for “EE,” each program number currently in the disk can be selected via the Jog dial.

- (3) Input the chain number via the Jog dial and press the [EXECUTE/YES] key. The flashing section will move from left to the right “EE.”



- (4) Select the desired program number via the Jog dial and press the [EXECUTE/YES] key. The chain number of the selected program will be set and, the same as in <Step 2>, the left section will flash. For example, if it has been set as shown below, the setting will be for playback of the program 5 tune in the second order.



Repeat these procedures to set up the chain play number in the desired program.

**<Setup example of the chain play list>**  
 As an example, if the chain play list is set as shown below, chain play is possible in the order of: program 3 - program 5 - program 2.  
 If the chain list is to be ended after program 1, as shown in the example below, set “EE” at fourth (“c04”) in the chain list.  
 By selecting “EE,” the chain play list setting will be “c01” - “c03,” and beyond “c04” will be invalid. “EE” can be selected with the Jog dial while the right program number is flashing.

**<Notes>**

- In order to execute chain play, “AUTO RTN START point” and “AUTO RTN END point” must be setup in each program to be played back. Refer to previous page “54” for how to register memory points.
- If the chain play list is edited even once, the Chain Play Mode will be set “OFF.” In such case, after setup of the chain play list, reset the Chain Play Mode to “ON” .



**Setup of the Chain Play Mode**

Upon setup of the previous “**Chain Play List**,” select the desired mode in the “**Chain Play MD?**” (Setup of the chain play mode) menu in the same SETUP mode.

**<Important>**: Be sure the Chain Play List is set up correctly before setting the chain play mode. Each setting of the chain play mode except “**Off**,” will not function if the previously mentioned “**Chain play list**” is not set up correctly beforehand. If the mode is executed while set up of with an incorrect list, after displaying “**Illegal P.List!**,” the D2424LVmkII will automatically go to the previously mentioned “**Chain Play List?**” menu.

**<Note>**: The chain play mode setting will be held even though power is switched off, and if power is switched when the D2424LVmkII is set to pause mode, the recorder will automatically execute chain play. If chain play is no longer required, reset to “**Off**” the “**Chain Play?**” menu after ending chain play.

- (1) Press the [SETUP] key while the D2424LVmkII is in the stop mode to switch to the SETUP display.
- (2) Display the “Chain Play MD?” menu via the Jog dial and then press the [EXECUTE/YES] key.  
The recorder will change to the display for setting up of the chain play mode and the present setup mode will flash (In the initial setup, “Off” will flash).

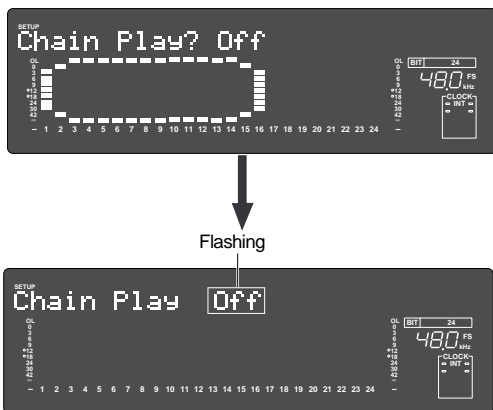

- (3) Select the desired mode via the Jog dial.  
When the Jog dial is rotated, modes other than the currently shown “Off” listed below can be selected.

“Off”	Refer to previous page 61 on the function of each mode.
“Pause” (Pause mode)	
“Auto P” (Auto play mode)	
“Rpt” (Pepeat mode)	

- (4) Press the [EXECUTE/YES] key after selecting the mode.  
The recorder will exit from the SETUP mode after setup is completed.

In this step, if it was completed in the setup other than the “Off” mode, the D2424LVmkII will automatically locate to the “**AUTO RTN START point**” of the first program in the previously setup “**Chain list**” and stop.

If it was completed after setup to “Off,” the D2424LVmkII will return to the first display of the program prior to entering the SETUP mode.).

If the D2424LVmkII is played back after this, functions of the mode selected will be executed from the first program in the chain list.

Normally, in chain play as explained above, execution starts from the first program on the chain list but any program of your choice can be specified and chain play executed from that program. For details, refer to “**Specify the program and execute chain play**”.

**<The “Current” display after setup>**  
If the “Chain Play?” menu is set to other than “Off” (“Pause,” “Auto P” or “Rpt”), then exit from the SETUP mode, the current display will change as shown in example below and, the display will be different from when it is set to “Off.”

**<When “Chain Play?” is set to “Off.”>**



**<When “Chain Play?” is set to other than “Off.”>**



The above is an example showing that program 03 (P03) activated by the ABS time base, is set at fourth in the chain list.

As shown here, when the chain list is correctly setup and the “Chain Play?” menu set to other than “Off,” in which order (For example, “c04”) of the chain list had the presently active program been setup, will be indicated. Should it be changed to another time base, the chain list number will be indicated in the same manner.

**Specify the Program and Execute Chain Play**

Specify at random a program set in the chain play list and execute chain play from the program specified. This operation can be executed only when the “Chain Play?” menu is set in other than “Off.”

**<Note>**: You cannot record or edit in the chain play mode. It will only play back the program set in the chain play list.

- (1) **Press the [PGM SEL] key while the D2424LVmkII is in the stop mode.**  
 After “Select Chain No!” is displayed, the first number in the present chain play list will flash and the program, and its title, will be displayed.

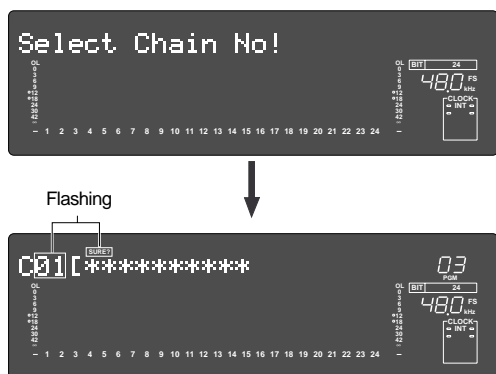

- (2) **Select the desired program with the Jog dial and press the [EXECUTE/YES] key.**  
 The sequence number currently set in the chain list can be selected by rotating the Jog dial. The program/title in selected order will be simultaneously displayed. After selection, when the [EXECUTE/YES] key is pressed, the D2424LVmkII will locate to the “AUTO RTN START point” of the selected program.
- (3) **Start playback by pressing the [PLAY] button.**  
 Chain play will be execute in compliance to the currently set “Chain Play MD?” mode.



# Cue & Review Function

This chapter explains how to use the “Cue & Review” function with the [REWIND] button, the [F FWD] button, and the Shuttle dial, and also explains “Digital Scrubbing” with the envelope function. During Cue/Review and Digital Scrubbing you will hear the sound recorded on the disk, which makes it easy for you to swiftly locate the desired point without failure while listening to the sounds.

*The prerequisite of the following operation is that the time base is ABS, however, the operation can be executed in any time base. To execute this function with a non-ABS time base there is a need to priory switch over to the desired time base.*

## Cue & Review function using the [REWIND] and [F FWD] buttons

You may cue & review the audio data at five-times speed while the recorder is playing.

- (1) Press the [PLAY] button to play the audio data.
- (2) Press the [F FWD] button during playback.  
This cues in the forward direction at five-times speed. The PLAY LED and F FWD LED lights up while cuing is taking place.
- (3) Adjust the monitor sound of the track to monitor on the mixer.
- (4) Press the [PLAY] button again to restore the original play back speed.
- (5) Press the [REWIND] button instead of the [F FWD] button.  
This cues in the rewind direction at five-times speed. The PLAY LED and REWIND LED lights up while cuing is taking place.
- (6) Press the [PLAY] button to restore the original playback speed.

## Cue & Review function using the Shuttle dial

You can use the Shuttle dial for +1~-7 times or -1~-8 times

- (1) Press the [PLAY] button to start playback.
- (2) Turn the Shuttle dial clockwise during playback.  
The forward direction cue speed variates from +1~-7 times speed depending on the degree (angle) of turning the dial. PLAY LED flashes and F FWD LED lights up during the cue process.
- (3) Adjust the monitor sound of the track to monitor on the mixer.
- (4) Let go of the Shuttle dial to return to normal play speed.
- (5) Similarly, turn the Shuttle dial counterclockwise during playback.  
The rewind direction review speed variates from -1~-8 times speed depending on the degree (angle) of turning the dial. PLAY LED flashes and REWIND LED lights up during the review process.
- (6) Let go of the Shuttle dial to return to normal play speed.

## Digital scrubbing using the envelope function

You may perform digital scrubbing using the “Envelope Function” of the recorder while the recorder is stopped. The envelope function allows digital scrubbing for each track recorded. The display will show the envelope indication of the track selected.

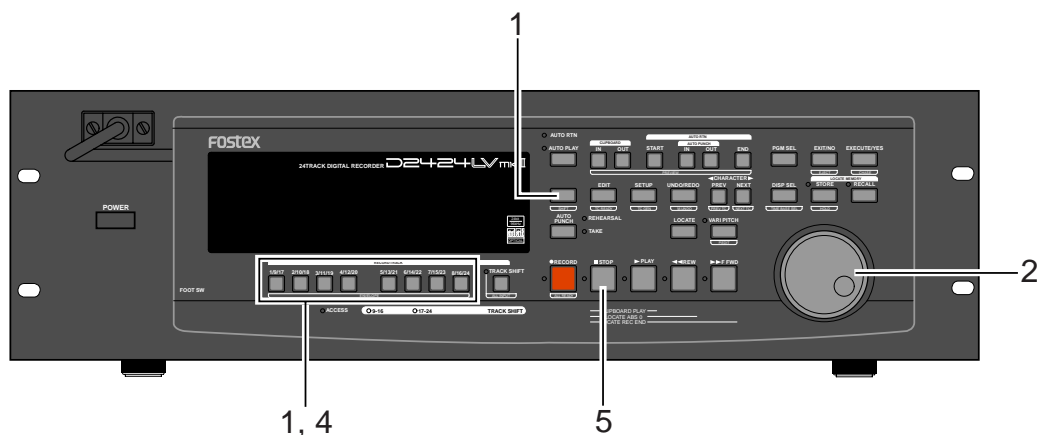

- (1) While the recorder section is stopped, depress the [SHIFT] key and then press the [RECORD TRACK] select key of the desired record track.**

This turns ON the envelope function.

The envelope indication of the selected track will appear on the display.

The following example shows the indication of track 4 envelope, after [RECORD TRACK] select key [4/12/20] is pressed. At this time the recorder is in the STILL status (scrub mode is in still status) and the REWIND LED and F FWD lights up.

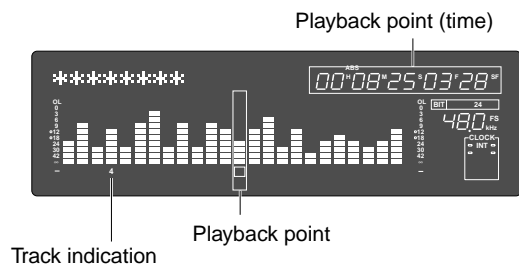

- (2) You can use the Jog dial to digitally scrub the performance of the track selected.**

The envelope of the performance recorded on the track varies in real-time. During forward direction scrub the F FWD LED lights up, and during rewind direction scrub the REWIND LED lights up.

- (3) Adjust the monitor sound of the selected track so that it can be monitored on the mixer.**

- (4) Press the [RECORD TRACK] select key of the desired record track to select another track.**  
 "Please Wait!" will briefly appear and then go to the envelope indication of the selected track.

The following example shows the case when the indication is switched from track 4 to track 12.

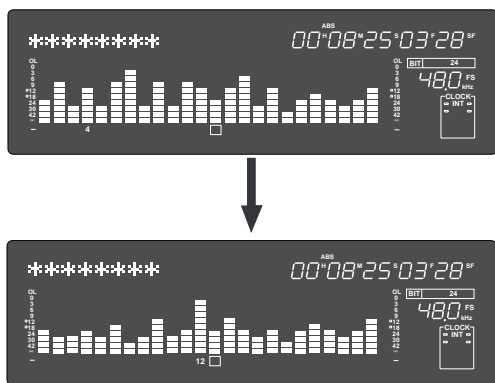

- (5) Press the [STOP] button to stop the envelope function.**

Doing so will turn OFF the envelope function.

The recorder will return to the time base indication prior to turning the envelope function ON.

# Preview Function

The preview function enables you to repeatedly audition the rise (fade in) or the fall (fade out) of the sound data at a locate point (edit point) that is stored in the [AUTO PUNCH IN/OUT], [AUTO RTN START/END], or [CLIPBOARD IN/OUT] key. This is also called “point rehearsal.”

With this function, you can check the locate points in real-time. You can also use this function to fine-tune the position of the locate points while previewing the sound. This function is effective only when the recorder is stopped.

## • Previewing the rise of the sound (fade in)

While holding down the [SHIFT] key, press the [AUTO RTN START] key, the [AUTO PUNCH OUT] key, or [CLIPBOARD IN] key.

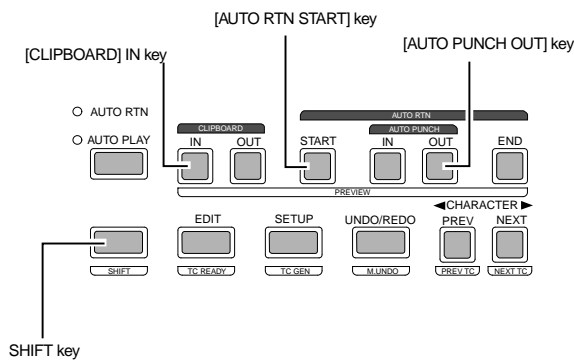

## • Previewing the fall of the sound (fade out)

While holding down the [SHIFT] key, press the [AUTO END START] key, the [AUTO PUNCH IN] key, or the [CLIPBOARD OUT] key.

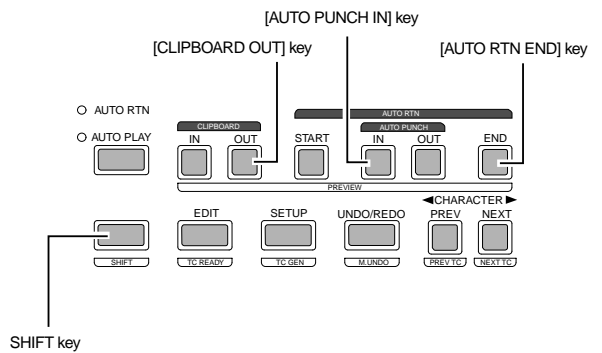

### <Display indication during the Preview operation>

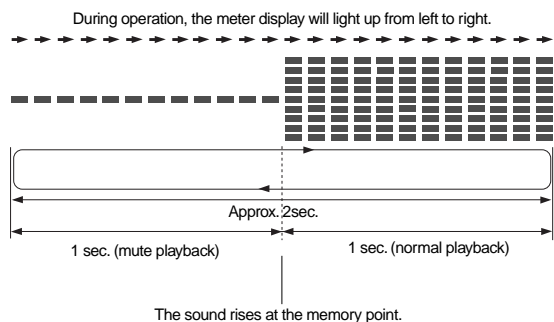
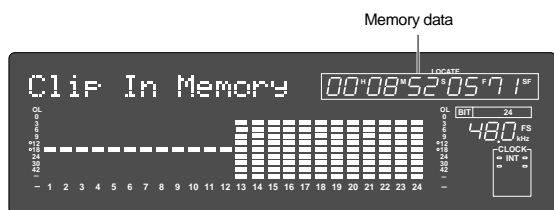

The recorder repeats playback the “**rise sound**” at the locate point (edit point). As shown in the diagram, one-second of data prior to the locate point is muted during playback. The mute is off (fade in) at the locate point and the sound is played back for one second. The recorder will repeat this operation until you quit the Preview function.

### <Display indication during the Preview operation>

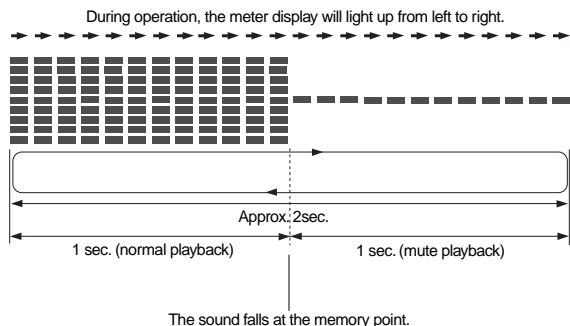

The recorder repeats playback of the “**fall sound**” at the locate point (edit point). As shown in the diagram, one-second of data prior to the locate point is played back, then muted (fade out) at the locate point. The muted playback continues for one second. The recorder will repeat this operation until you quit the Preview function.

### Executing the Preview function

- (1) **Press the desired memory key while holding down the [SHIFT] key when the recorder is stopped.**

Pressing the desired memory key will enable you to preview the sound at the locate point (edit point) stored in the corresponding memory key.

Memory key	Operation
[AUTO PUNCH IN] key [AUTO RTN END] key [CLIPBOARD OUT] key	The recorder plays the fall (fade out) of the sound at the locate point stored in the keys.
[AUTO PUNCH OUT] key [AUTO RTN START] key [CLIPBOARD IN] key	The recorder plays the fall (fade in) of the sound at the locate point stored in the keys.

- (2) **Adjust the monitor sound of the selected track so that it can be monitored on the mixer.**

**<Note>**: If data stored in each memory key is in the initial state, all memory keys will be in ABS time 00H 00M 00S. In other words, the program head value is in the memory. Should fade out preview be executed in this condition, the "Void Data!" message and memory data "00H 00M 00S" will alternately flash in the display as a warning. However, for fade in preview, this will function as the memory data "00H 00M 00S" point.

- (3) **Press the [STOP] button or the [EXIT/NO] key.**

### Trimming the sound while previewing

You can trim the position of the locate point (edit point) using the **Jog** dial while you preview the sound. At this time, you can also adjust the size of the trimming steps (the amount of offset controlled by the Jog dial).

Trimming allows you to fine-tune the position of the locate point stored in the memory keys while previewing the sound. Use this function to change the Auto Punch In/Out points, the start point of Copy & Paste and Move & Paste, and the start and end points of the Erase function.

**<Notes>**

- You can audition the result of trimming during the next preview. That is, if you trim the position while previewing the sound for the first time, you can check the result when you preview the sound next time.
- If the locate point is shifted outside the range of the preview playback as a result of trimming, "Void Data!" and the locate point indication appear alternately. In this case, you cannot use the Preview function. Trim the position again so that it will be within the playback range.
- When Auto Punch mode is turned on and you trim the Auto Punch In or Auto Punch Out point while previewing the sound with "Void Data!" indicated on the display, Auto Punch mode will be cancelled.

- (1) **Start previewing the sound by following the steps described on the previous page.**

- (2) **Use the Jog dial to trim the position.**

When previewing starts, the unit of Jog trimming flashes on the screen.

For example, value of **SF** (sub-frame) flashes if ABS Time Base or MTC Time Base is selected.

**CLK** (clock) flashes if BAR/BEAT/CLK is selected. The flashing value also indicates the position you can trim.

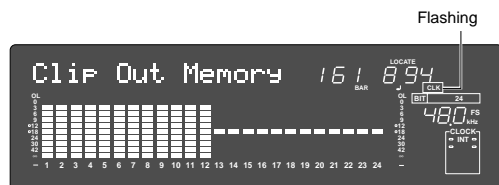
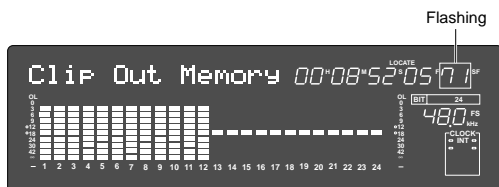

- (3) **To change the unit of trimming, turn the Shuttle dial.**

	Time base	
	ABS or MTC	BAR/BEAT/CLK
Shuttle dial (clockwise)		
Shuttle dial (counter clockwise)		

- (4) **Trim the position at the selected unit (digit).**

- (5) **Press the [STOP] button or the [EXIT/NO] key.**  
The trimmed locate point (edit point) data will be stored in the corresponding memory key.

# Multiple Undo Function

To undo recordings or edits, you can use the **Multiple Undo (Time Jump) function** (explained in this section) as well as the Single Undo/Redo function (explained in the Quick Operation Guide and the “Punch in/out” and “Track editing” sections of this manual).

You can use the **Multiple Undo (Time Jump) function** only for a current drive disk that was formatted with the Multiple Undo turned on. (See page 31 for more information on the format operation.) The Single Undo/Redo function enables you to undo and redo the current take of recording or edit (Punch in/out, Copy & Paste, Move & Paste, Erase). However, if you record a new take, you will no longer be able to apply the Undo/Redo function to the previous take.

On the other hand, the **Multiple Undo (Time Jump) function** can be applied to all takes made after the current drive disk is formatted. To undo a take, select the date and time (at which you finish making the corresponding take) of the edit based on the internal clock.

When you finish recording or editing a take on a current drive disk that was formatted with the Multiple Undo function turned on, that take will get the time stamp of the internal clock (e.g.: [10:50.37 11.Dec?]). Therefore, you can always recall the desired take. This is quite different from the Single Undo/Redo function.

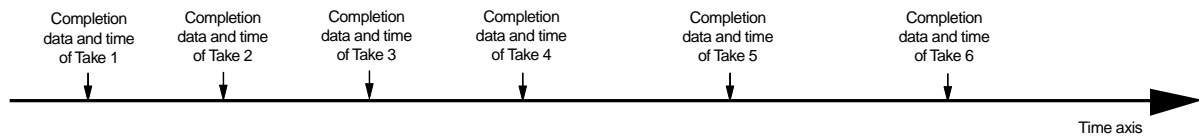

## <Notes regarding the Multiple Undo operation>

- The time stamp of each take references to the internal clock of the recorder. Therefore, after formatting the current drive disk, be sure to set the internal clock correctly. Refer to the Quick Operation Guide for more information on how to set the internal clock.
- Recording (or editing) more takes will consume more disk space on a current drive disk that was formatted with the Multiple Undo function turned on. This is because more disk space is required to enable the Undo function for any take. Therefore, such a current drive disk with a smaller capacity may not have enough disk space to perform the Multiple Undo function. In this case, performing the disk optimization in Setup mode may increase the free space available for the Undo function. (For more information, see the “Helpful Tips” on page 70.)
- If you use the Multiple Undo function, you cannot use the Single Undo/Redo function.
- If you try to use the Multiple Undo function on a current drive disk that was formatted with the Multiple Undo function turned off, the recorder displays “Void!” and ignores your operation.

## Using the Multiple Undo function

- (1) **While the recorder is stopped, press and hold down the [SHIFT] key and press the [UNDO/REDO] key.** The recorder displays the date and time of a take (as shown below), and “?” and “SURE ?” flash. To select the date and time for another take, turn the Jog dial.

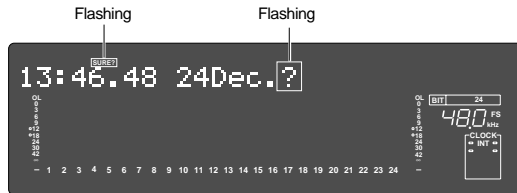

- (2) **Use the Jog dial or the [NEXT] key and [PREV] key to select the desired date and time, and press the [EXECUTE/YES] key.**

The recorder displays “Multiple Undo” momentarily, performs the Undo function, and recalls the time base indication that was shown before the function was performed. “COMPLETED!” lights up on the screen.

- (3) **Press the [EXIT/NO] key or the [STOP] button.** “COMPLETED!” turns off.

### <Helpful Tips>

To increase the free space on the disk available for the Multiple Undo function, optimize the current drive disk using the “Disk Optimize?” menu in Setup mode. However, remember that if you optimize a current drive disk that recorded several takes, only the most recent take will remain and other takes will be erased. If you wish to keep other takes, follow the procedure below, then optimize the disk.

### <Keeping only one take>

- **First, apply the Multiple Undo function to the take you wish to keep, then optimize the disk.**

For example, if six takes exist on the disk, as shown below, and you wish to keep only Take 4, apply the Multiple Undo function to Take 4.

As shown on the second time axis, Take 4 moves up to the most recent position. Now, if you optimize the disk, all takes but Take 4 will be erased.

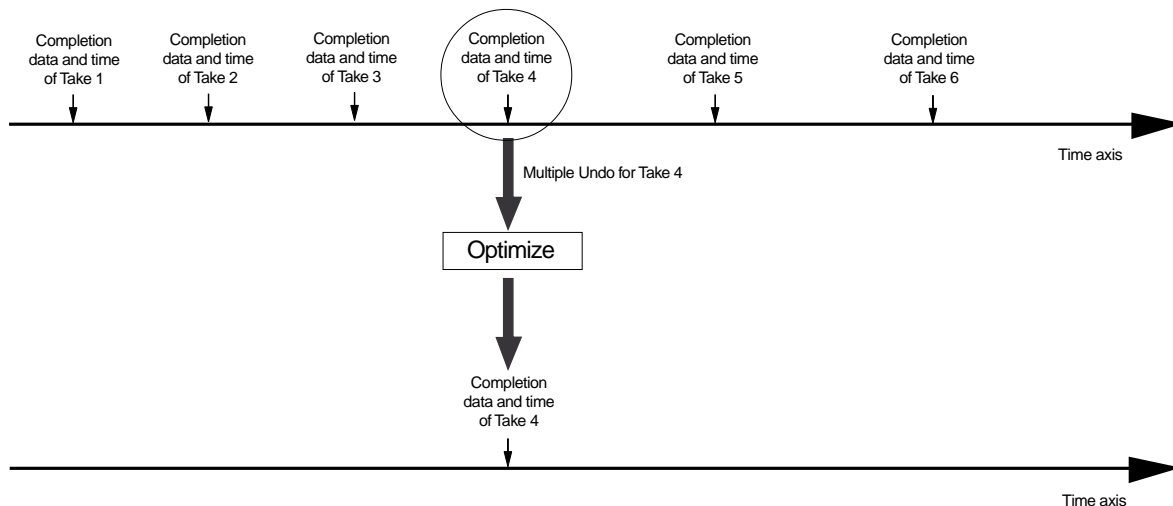

### <Keeping multiple takes>

- **Apply the Multiple Undo to the desired takes and copy the Program.**

For example, if you wish to keep Take 2 and Take 4, follow the procedure described above to apply the Multiple Undo function to Take 2, then create a copy of the Program. (The Program copy will have only Take 2 available for the Multiple Undo function.)

In the same way, apply the Multiple Undo function to Take 4 this time, then create another copy of the Program. In this way, you can create copies of the Programs that contain the desired takes.

# Editing Tracks

The recorder features speedy, nonlinear, nondestructive editing of independent audio tracks because it uses a 3.5 inch E-IDE hard disk. The following four editing functions allow “**Editing of Independent Audio Tracks.**”

**Copy & Paste**  
 You can copy a specific range of data from a specific track and paste it to the same or a different track. Copy & Paste is possible in the presently active program or also in a different program.

**Move & Paste**  
 You can move a specific range of data from a specific track and paste it to the same or a different track.

**Move & Paste**  
 You can erase a specific range of data from a specific track or all tracks.

**Track Exchange**  
 Between tracks 1-56, exchanging is possible in mono track units or group track units (Stereo pair 2 tracks or 8 tracks).

**Editing the track name**  
 Any type of track name can be registered and edited for each channel.

**<Note>**: Although Copy & Paste can be executed in a different program, all other editing work can only be done within the currently active program. Consequently, in order to edit the active program, the desired program should be selected before starting to edit. In general, don't change a program until you finish editing except to Copy & Paste to a different program. If editing is started while in another program, you could accidentally lose data. Copy & Paste, Move & Paste, and Erase with the exception of track exchange and editing the track name, is possible only for data recorded on the real track. If data stored in the additional track is to be edited, move it temporarily to a real track, and then edit it.

## Copy & Paste and Move & Paste

Copy & Paste and Move & Paste might seem like the same function. However, they are different, as shown in the diagram. Remember this difference when you start using these functions.

### • Copy & Paste

Using the Copy & Paste function enables you to copy a specific range of data from a specific track to the clipboard as shown below (this is called “**Copy Clip**” operation on the unit), then paste the data at a specific point in a specific track.

The number of copy source tracks and the number of destination tracks are the same. That is, if you copy mono track data, you can paste it to a mono track. If you copy adjacent odd/even tracks (e.g., track 1 and track 2), you can paste it to adjacent odd/even tracks. After paste is executed, data on the clipboard will remain intact and as can be repeatedly pasted, as well as to other programs.

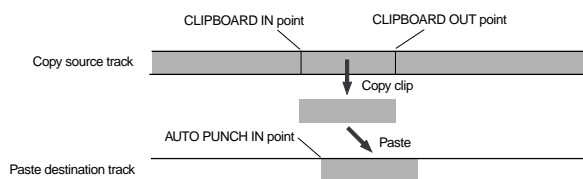

### • Move & Paste

Move & Paste is almost the same as Copy & Paste. As shown in the figure, it allows you to move a specific range of data from a specific track to the clipboard (this is called “**Move Clip**” on the unit), and paste it to a destination track.

The difference from Copy & Paste is that the data on the source track and the clipboard will be erased when you paste the data to the destination. That is, you cannot paste the moved data repeatedly. Unlike Copy & Paste, this cannot be executed between programs.

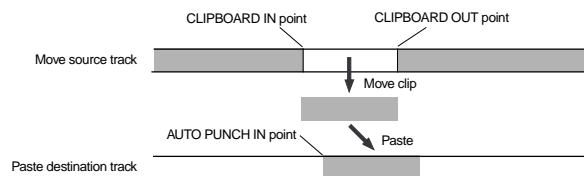

As shown in the drawing, points for copy or move are called the **CLIPBOARD IN point** for the copy (or move) starting point, and **CLIPBOARD OUT point** for the ending point, and the paste starting point is called the **AUTO PUNCH IN point**.



**<Notes>**

- The data on the clipboard will be replaced by new data each time you execute the COPY or MOVE.
- If pasted data overlaps the source data, the content of the source data will be altered.

Perform Copy & Paste and Move & Paste in the following order. The explanation here is on Copy & Paste or Move & Paste methods in the currently active program. **For Copy & Paste between programs, read page “71”.**

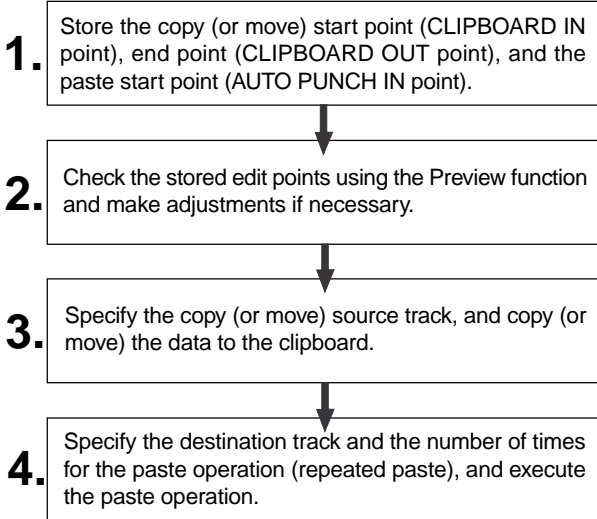

**• Storing the edit points**

- (1) **Refer to the “Storing and editing the locate points to the memory keys” section for information on storing the copy (or move) start and end points, and the paste start point.**

Store the copy (or move) start point to the [CLIPBOARD IN] key, the end point to the [CLIPBOARD OUT] key, and store the paste start point to the [AUTO PUNCH IN] key.

• See “Storing and editing the locate points to the memory keys” on page “54.”

**• Checking and adjusting the edit points**

After you store the edit points, you can check them on the display by pressing the corresponding keys. You may also adjust the points. This section explains how to preview and fine-tune the edit points using the Preview function.

- (1) **While the recorder section is stopped, press and hold down the [SHIFT] key and press the memory key for which you wish to check the edit point.**

You can preview “fade in” at the CLIPBOARD IN point, “fade out” at the CLIPBOARD OUT point, and “fade out” at AUTO PUNCH IN point.

- (2) **Trim the edit point while previewing.**

• Refer to “Preview Function” on page “67” for more information.

**• Executing Copy (or Move)**

**<Note>**: You can carry out the copy (or move) function only when the “Chain Play?” menu in the Setup mode is set to “Off.” If you press the [EDIT] key when this menu is not set to “Off,” “Void Chain Play!” is shown and the operation is ignored. If “Void Chain Play!” is shown, set the “Chain Play?” menu to “Off.”

- (1) **Press the RECORD TRACK select key of the copy (or move) source track to set it READY.**

Select from mono tracks or adjacent odd-even tracks (1-2, 3-4, 5-6 etc.).

**<Note>**: If you select non-adjacent tracks, such as track 1 and 3, or tracks 1 and 4, the copied (or moved) data will be pasted back to the copy (or move) source tracks.

- (2) **Press the [EDIT] key repeatedly until “Copy Clip?” (or “Move Clip?”) flashes on the display.**

Select “Copy Clip?” to execute Copy & Paste. Select “Move Clip?” to execute Move & Paste.



- (3) **Press the [EXECUTE/YES] key.**

The copy (or move) operation will complete immediately. The display briefly indicates “COMPLETED !”, then flashes the “Copy Paste ?” (or “Move Paste ?”) message. The recorder enters standby mode for the paste operation. The indicates (small square) of the selected [RECORD TRACK] select keys continue to flash.

**<Notes>**

- Pressing the [EXECUTE/YES] key without selecting track in Step 1 will cause the display to indicate an alarm message “Select TRK !”. Select a track, then press the [EXECUTE/YES] key.
- If an Output has been specified before the In point (the In point value is the same or large than the Out point value), the display will show the error message “Void In Point!” or “Void Out Point!” and the return to the previous screen. In this case, set the correct In/Out points and try again to copy (or move) the data.

Now the sound data to be pasted has been copied (or moved) to the clipboard, you can check the data on the clipboard by following the steps below. If there is no problem with the data, you can proceed to the paste operation.



**• Checking the clipboard data**

- **Hold down the [STOP] button and press the [PLAY] button.**  
The recorder indicates whether the sound data on the clipboard is a copied data or moved data (“Copy Clip” or “Move Clip”) and plays the data (this is called “clipboard playback”). Monitor the playback sound through the mixer channels that correspond to the copied (or moved) tracks. During clipboard playback, the indicators of the [RECORD TRACK] select key for the copied (or moved) track will flash.
- **Press the [EDIT] key again to get ready for the paste operation.**  
“Copy Paste?” or “Move Paste?” flashes on the display.

**• Executing Paste**

- (4) **Press the [EXECUTE/YES] key again.**  
The display indication enables you set the number of the paste operations. The number and “SURE?” flash. At this time, the flashing [RECORD TRACK] indicator becomes continuously lit.

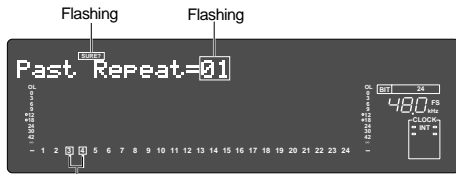

Track display (□) of the item to be copied (or moved) will change to lit.

- (5) **Select a destination track to paste data.**
  - If paste is to be done on the same track, it is not necessary to select the track.
  - Changing the destination track for paste is permissible to a mono track or adjacent two tracks in odd and even numbers (1-2, 3-4, 5-6, etc.) only when the copy (or move) data is on the clip board.  
For this procedure, if the [RECORD TRACK] select key of the track to be changed is pressed, and an objective track for pasting can be selected.
  - If a multiple number of tracks (1-3, 5-8, etc.) other than those above had been copied (or moved), paste can be done only to the same track as that of the copy (or move) originating track. The track cannot be selected even though the [RECORD TRACK] select key is pressed.
- (6) **Turn the Jog dial to enter the number of repeats (Repeat = \*\*).**  
You can enter up to 99.  
However, this is automatically limited by the available recording source on the disk.  
That is, if the disk has enough free space, you can set up to 99 repeats. If the disk has only a small amount of free space, the Jog dial allows you to set a lower number of repeats.
- (7) **Press the [EXECUTE/YES] key.**  
“Copy Paste” (or “Move Paste”) flashes and the duration of the pasted data appears as a negative number on the display.

This number will count down as the paste operation proceeds. When the paste operation is complete, the flashing “Copy Paste” (or “Move Paste”) lights up continuously, and “COMPLETED !” is displayed.

**<Note>:** If you try to execute the paste operation by pressing the [EXECUTE/YES] key when the disk has insufficient free space, “Over !” appears on the display and edit mode is cancelled. In this case, you need to delete unnecessary data or programs.

- Refer to the following section, “Erase,” “Deleting a Program,” or “Duplicating a Program.”
- Refer to page “76” for more information on erasing.
- Refer to page “40” for more information on deleting a program.
- Refer to page “39” for more information on duplicating a program.

- (8) **Press the [EXIT/NO] key or the [STOP] button.**  
The recorder exits edit mode and displays the previous Time Base indication.
- (9) **Turn off the [RECORD TRACK] select key of the copy (or move) source track.**

**• Single Undo/Redo Paste**

You can single undo or redo a Copy & Paste and Move & Paste operation.

- **To restore the data that existed prior to the paste operation, press the [UNDO/REDO] key.**
- **To restore the pasted data after you undo the paste operation, press the [UNDO/REDO] key again.**

When you press the [UNDO/REDO] key, the recorder will undo or redo the operation immediately, and display “Undo !” or “Redo !” and “COMPLETED !”.

**<Note>:** This function only works when this recorder is in the stop mode.

**<Note>:** If you perform one of the following operations after you use the Copy & Paste or Move and Paste operation, the Undo/Redo function will no longer be effective.

1. If a new recording has been made.
2. When a new editing job is executed (such as Copy & Paste, Move & Paste, Erase).
3. While in the AUTO PUNCH ON mode, when the AUTO PUNCH IN point is passed in the PLAY (or RECORD) mode.
4. If the power was switched off.
5. If program select was executed.
6. When multiple undo is executed.

## • Copy & Paste between programs

Copy & Paste between programs can be performed using the procedures below in the same manner as in the previous “Copy & Paste in the same program.”

### <Notes>

- Only copy/paste can be executed between different programs. Move/paste cannot be executed between different programs.
- Do not copy/paste between programs with different FS such as copy/paste FS=48kHz program data to an FS=44.1kHz program. Sound data cannot be guaranteed if copy/paste had been executed between programs with different FS.

## • Checking the clipboard data

Data copied to the clipboard can be confirmed even after switching the program by the above procedure.

For example, when a specific data in Program 1 is copied to the clipboard and then switched to Program 2 in which it is to be pasted, as mentioned before, if the [PLAY] button is pressed while pressing on the [STOP] button, you can listen to data copied in Program 1 (clipboard play).

During clipboard play, “P01” will appear in the display to indicate that copy data in Program 1 is being played back.

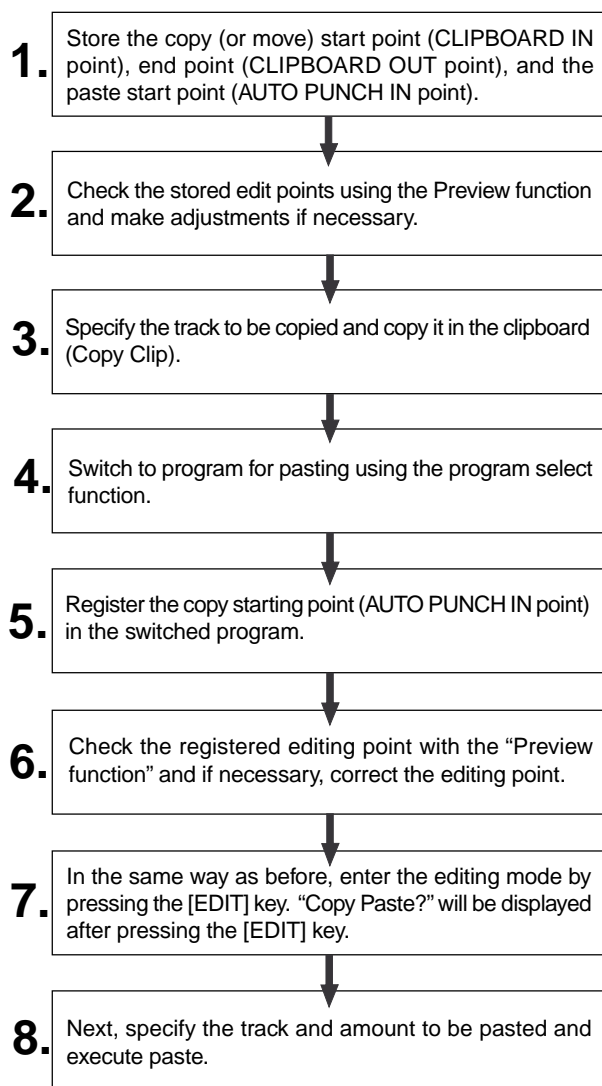

**Erase**

There are two methods for erasing data. Understand the difference between these methods before you use the Erase function.

- If multiple Programs are set on the disk, first select the desired Program. Do not select another Program, or select another sampling rate until you finish the erase operation.

**• Erasing a specified part of the data between ABS 0 and REC END:**

You may erase a specified part of the data between ABS 0 and REC END (the end point of the recording) in the currently-selected Program. (The erased part is replaced with silence.) You can erase data on a mono real track or multiple real tracks. To erase data on an additional track, you need to move the data to a real track, then erase it. As shown below, the REC END point (the end point of recording) is not affected. The erased area is replaced with silence. As a result, the REMAIN time and space will increase. (You will have more recordable space on the disk.)

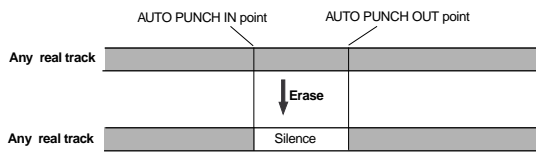

**• Erasing data from a specified point to REC END:**

You may erase all data in the range from a specified point to REC END in the currently-selected Program. You can erase data on a mono real track or multiple real tracks. To erase data on an additional track, you need to move the data to a real track, then erase it. When you erase all tracks' data, the REC END point will move backward. However, if you erase data on a mono track or multiple tracks (but not all tracks), the REC END point may not be affected. (Refer to the note below.) After the erase operation, the REMAIN time and space will increase.

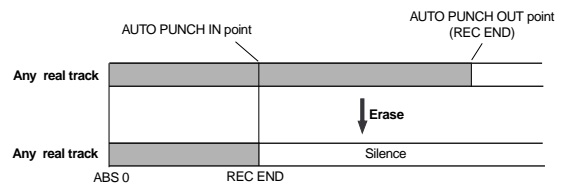

**<Note>:** If all real tracks contain data as shown below, erasing data on tracks 1 and 2 will not affect the position of REC END. On the other hand, if all Real tracks contain data as shown below, erasing data on tracks 3 - 6 will move up REC END to the end point of tracks 1 and 2.

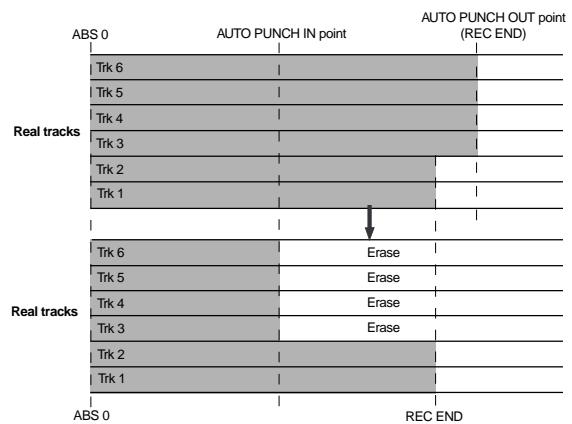
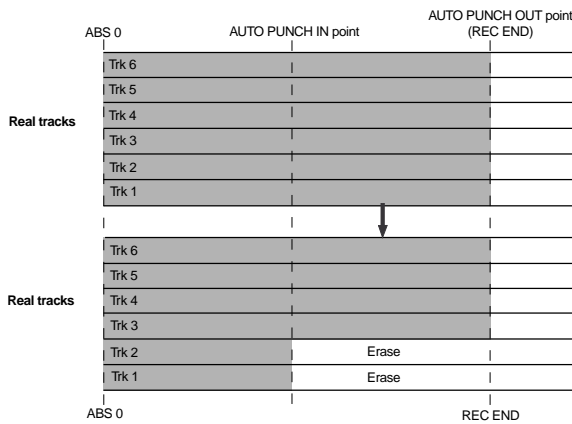

Follow the steps below to erase data:

1. Store the erase start point (AUTO PUNCH IN point) and the erase end point (AUTO PUNCH OUT point).
2. Use the Preview function to check the stored edit points and adjust them if necessary.
3. Specify a track to erase and execute the function.

**• Storing the edit points**

- (1) Refer to the “Storing and editing the locate points to the memory keys” section for information on storing the erase start and end points. Store the erase start point to the [AUTO PUNCH IN] key, and the end point to the [AUTO PUNCH OUT] key.

- If you wish to erase the data from a specific point, store the REC END or later point as the erase end point. Refer to the <Note> for information on storing the REC END point.
- See “Storing and editing the locate points to the memory keys” on page “54”.

### • Checking and adjusting the edit points

After you store the edit points, you can check them on the display by pressing the corresponding keys. You may also adjust the points.

- (1) **While the recorder section is stopped, press and hold down the [SHIFT] key and press the memory key for which you wish to check the edit point.** You can preview “fade-out” at the AUTO PUNCH IN point and “fade-in” at AUTO PUNCH OUT point.
- (2) **Trim the edit point while previewing.**

• Refer to “Preview Function” on page “67” for more information.

### • Executing Erase

**<Note>**: You can carry out the erase function only when the “Chain Play?” menu in the Setup mode is set to “Off.” If you press the [EDIT] key when this menu is not set to “Off,” “Void Chain Play!” is shown and the operation is ignored. If “Void Chain Play!” is shown, set the “Chain Play?” menu to “Off.”

- (1) **Press the [RECORD TRACK] select key to select the track to erase, to set it READY.** You can select a mono track or multiple tracks (including all tracks). The selected track indication flashes.
- (2) **Press the [EDIT] key repeatedly until “Erase” flashes on the display.**
- (3) **Press the [EXECUTE/YES] key.** The flashing “Erase” message lights up steadily, and “SURE?” flashes.

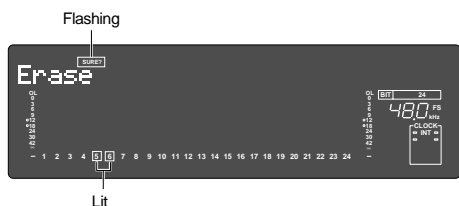

• To cancel the erase operation, press the [STOP] button or the [EXIT/NO] key while “SURE ?” flashes on the display.

- (4) **Press the [EXECUTE/YES] key again.** The recorder starts erasing the data and “Wait Erasing!” flashes. When the erase operation is completed, “COMPLETED !” lights up.
- (5) **Press the [STOP] button or the [EXIT/NO] key.** The recorder exits edit mode and displays the previous Time Base indication.

### <Check Points!>

- To erase the data in its entirety from the tracks, you can also use the Program Delete function to erase the entire Program. In either case, you can expand the recordable area on the disk. Use either one of the erase operations to erase unnecessary data if the recorder displays an alarm message indicating insufficient recordable space for Auto Punch In/Out, Copy & Paste, or Move & Paste.
- To erase the data in its entirety from ABS 0 - REC END, it is recommended that erase end point (AUTO PUNCH OUT point) is stored after the REC END time to ensure through erase performance. To do this, move the recorder section location to the REC END point prior to storing the AUTO PUNCH OUT point, press the [PLAY] button from that location, move the ABS time after the REC END, and store. The hard disk will not successfully access points after REC END though play is executed after REC END, however, this makes it possible to move up the ABS time.

### • Single Undo/Redo Erase

You can single undo or redo the Erase operation.

- **To restore the data that existed before you erased it, press the [UNDO/REDO] key.**
- **To restore the data after you undo the Erase operation, press the [UNDO/REDO] key again.**

When you press the [UNDO/REDO] key, the recorder will undo or redo the operation immediately, and display “Undo !” or “Redo !” and “COMPLETED !”.

**<Note>**: This function only works when this recorder is in the stop mode.

**<Note>**: If you perform one of the following operations after you use the Copy & Paste or Move and Paste operation, the Undo/Redo function will no longer be effective.

1. If a new recording has been made.
2. When a new editing job is executed (such as Copy & Paste, Move & Paste, Erase).
3. While in the AUTO PUNCH ON mode, when the AUTO PUNCH IN point is passed in the PLAY (or RECORD) mode.
4. If the power was switched off.
5. If program select was executed.
6. When multiple undo is executed.

## Track Exchange

"Track exchange" is the function that exchanges tracks -- all real tracks and all additional tracks-- currently in the programs, in mono track units or in multiple track (Stereo pair 2 tracks; 8 track units) units. In other words, exchanging tracks in any combination, as shown below, means that data recorded on those tracks will be relocated. This function enables effective use of tracks. Not only will it be possible to make exchanges between real tracks but, by dumping a real track to a blank additional track, another blank real track is created for future recording.

However, since data in this additional track cannot be directly played back in real time, if the data need to be played back or edited, it must be moved to a real track.

Also, as explained in the previous "Erase," "Track Exchange" is necessary when checking REC END in the additional track.

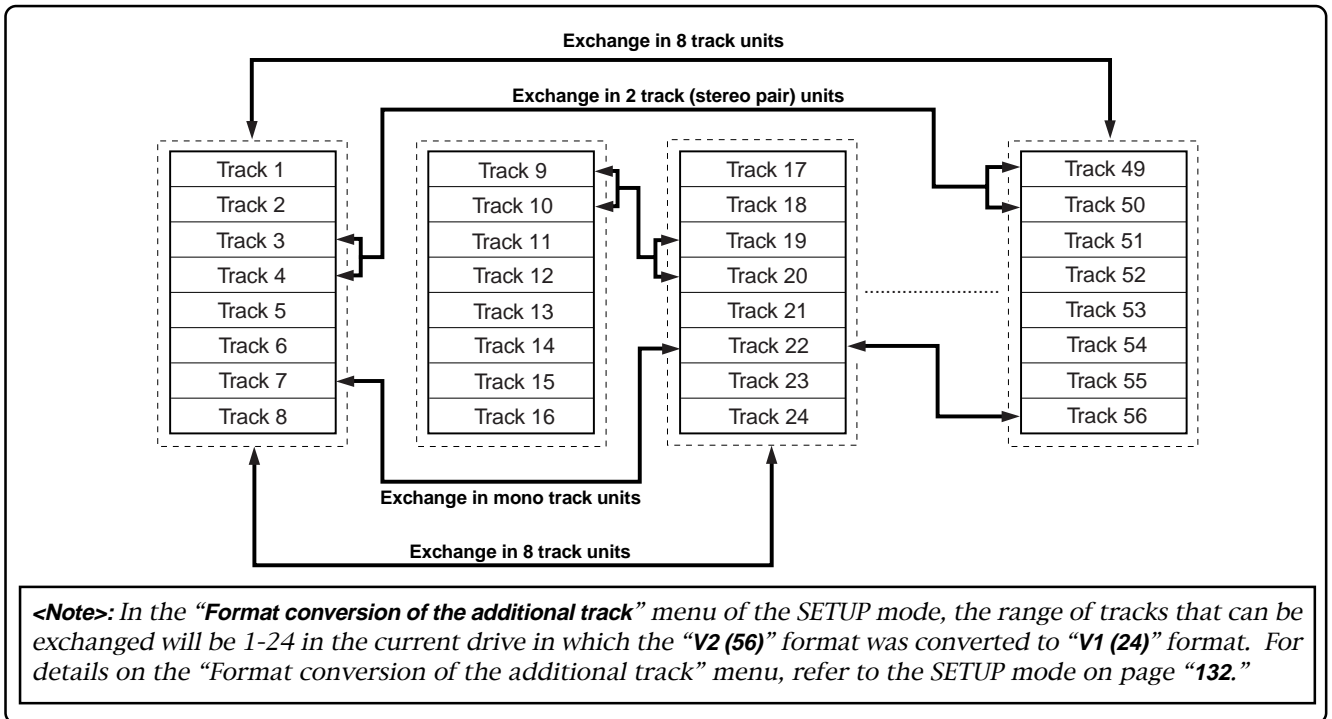

### • Execution of Track Exchange

**<Note>:** You can carry out the track exchange function only when the "Chain Play?" menu in the Setup mode is set to "Off." If you press the [EDIT] key when this menu is not set to "Off," "Void Chain Play!" is shown and the operation is ignored. If "Void Chain Play!" is shown, set the "Chain Play?" menu to "Off."

#### • Exchanging in mono units

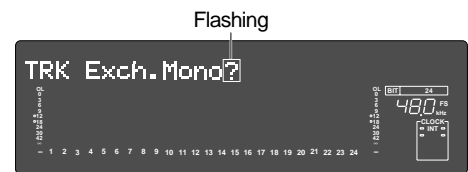

- (1) In the stop mode, press the [EDIT] key to display "TRK Exch.Mono?" or "TRK Exch.Group?." Select "TRK Exch.Group?" to exchange tracks in 2 track (stereo pair)/8 track units, and "TRK Exch.Mono?" to exchange in mono track units.

- (2) After either is displayed, press the [EXECUTE/YES] key. The display will change to selecting the tracks for exchanged. To actually select the tracks, please refer to the next page.

#### • Exchanging in group units

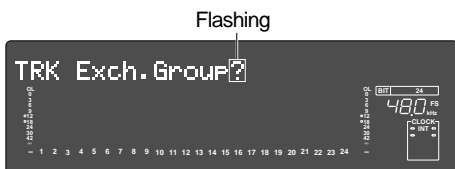

**• Exchanging in group track units**

- (1) By pressing the [EXECUTE/YES] key after "TRK Exch. Group?" is displayed, the display will change as shown below.

This display is indicating that, at present, tracks 1-8 and 9-16 can be exchanged.

"\*\*\*\*\*" is indicating the track name of the flashing track left two digits (In this example - Name of track 01).

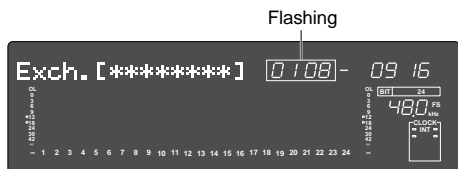

- (2) If the Jog dial is rotated while "01 08" is flashing, the 8 track unit numbers ("09 16," "17 24," "25 32," "33 40," "41 48," "49 56") or pair track unit numbers ("01 02," "03 04" ... .... "55 56") will be alternately displayed.
- (3) After selecting the left side track, press the [NEXT] key to move to the flashing right side.

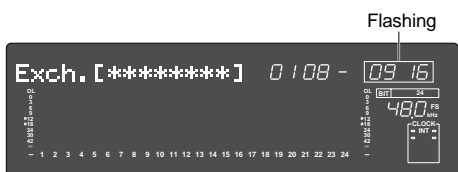

- (4) Display the desired track by rotating the Jog dial in the same manner as Step 2.  
If the flashing display is to be moved from right to left, either press the [REV] key or rotate the Shuttle dial.
- (5) After selecting the left right tracks, press the [EXECUTE/YES] key.  
Track exchange is executed and simultaneous with completion, "COMPLETED!" is displayed. The D2424LVmkII will then return to the display prior to entering the edit mode.  
Regardless as to whether "Exch.01 08-09 16" or "Exch.09 16-01 08" is input, there will be no difference in the fact that tracks 1-8 and tracks 9- 16 have been exchanged.

**• Exchange in mono track units**

- (1) Upon display of the previously mentioned "TRK Exch.Mono?," then pressing the [EXECUTE/YES] key, the display will change as shown below.

This display indicates that, at present, tracks 1 and 2 can be exchanged.

"\*\*\*\*\*" is indicating the track name of the flashing track. In this case, the name of track 01.

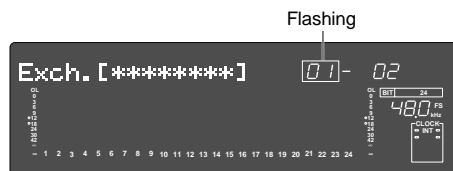

- (2) If the Jog dial is rotated when "01" is flashing, the mono track unit numbers ("01"- "56") will be alternately displayed.
- (3) After selecting the left side track, move to the right side flashing by pressing the [NEXT] key.

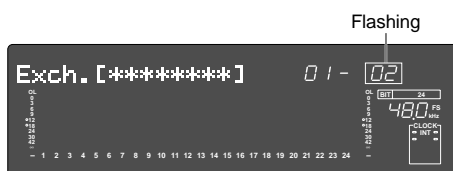

- (4) The same as in Step 2, display the desired track by rotating the Jog dial.  
Press the [REV] key or rotate the Shuttle dial to move the flashing number from right to left.
- (5) After selecting the left and right tracks, press the [EXECUTE/YES] key.  
Track exchange is executed and simultaneous with completion, "COMPLETED!" is displayed and then returned to the display prior to entering the edit mode.

Whether "Exch.01-09" or "Exch.09-01" is input, there will be no difference in the fact that track 1 and track 9 have been exchanged.

**<Notes>**

- You cannot select the same track for left and right.  
If the same track is mistakenly specified, "Select Err" will be displayed for an instant and then returned to the display prior to execution.
- As it stands, data in the additional track cannot be played back or REC END confirmed.  
To do this, data must be moved temporarily onto a real track. When saving the data to an external DAT, adat or the CompactFlash card, data on the additional track will be saved in its original state and, when reloading, will be reinstalled on the disk the same as prior to saving it.

## Registering the Track name

Any type of track name can be registered or edited for each real track/additional track. In general, after the current drive is formatted, a "Temporary title"("#TRACK 1," etc.) is automatically registered for all tracks.

This temporary title can be changed and registered as you wish using the "Track Name Edit?" menu in the SETUP mode.

For example, to allow checking at a glance, sound sources (guitar, keyboard, vocal...etc.) recorded on each track, a maximum 8 digit track name can be registered, such as "Guitar" for track 1, "Keyboard" for track 2, "Vocal" for track 3, and so on.

- (1) Enter the SETUP mode while in the stop mode by pressing the [SETUP] key.

- (2) Select the "Track Name Edit?" display by rotating the Jog dial, and then press the [EXECUTE/YES] key.

As shown below, the display will change to selecting the desired track and the track number will flash.

In the example below, "01" in "TRK:01" will flash.

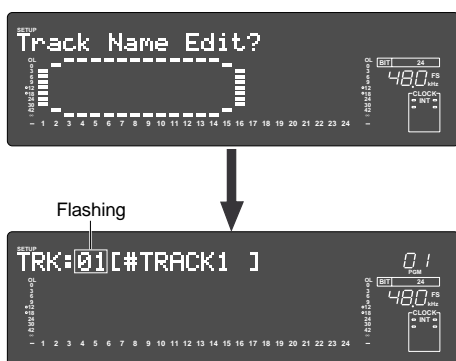

- (3) Rotate the Jog dial while "01" is flashing to select the desired track number, and press the [EXECUTE/YES] key.

The flashing number will move to the left-end digit to allow input of new letters and symbols. In example below, "#" will flash.



- (4) Numbers and symbols can be input at the selected (flashing) digit by rotating the Jog dial, and the flashing digit can be moved with the Shuttle dial.

If the Jog dial is rotated at the edit point, letters/numbers/symbols listed in the following can be input.

A maximum of 8 digits can be input for a name.

```

# $ % & ' ( ) * + , - . / 0 1 2 3 4
5 6 7 8 9 : ; < = > ? @ A B C D E F
G H I J K L M N O P Q R S T U V W X
Y Z [ \ ] ^ _ ` a b c d e f g h i j
k l m n o p q r s t u v w x y z { |
} ~ ` _ ! "
    
```

**<Hint>**  
 If the [PREV] key or [NEXT] key is pressed when inputting letters/symbols/numbers at the edit point (flashing position), it is possible to jump to the letters/symbols in the above square box. This is convenient for quickly selecting the letters/symbols/numbers to be input.

- (5) After input of the desired track name, press the [EXECUTE/YES] key.

By pressing the [EXECUTE/YES] key, the D2424LVmkII will change to the track number selecting display, the same as in Step-2 (Track number will flash).

- (6) If you wish to continue registering track names, repeat <Step-3> and <Step-4>.

- (7) Upon completing registering of the track names, press the [EXIT/NO] key to exit from the SETUP mode.

\* Example: Track 1 -> "Rhythm"



\* Example: Track 5-> "Vocal-A"



# MIDI Sync Function

The following are examples concerning general types of systems using MIDI related functions contained in the recorder.

## MIDI clock sync system

By setting any desired meter at any desired point of the programmable tempo map contained in the recorder, and by output of a MIDI clock and song position pointer according to the setting, a hardware type MIDI sequencer can be synchronized as a MIDI clock slave. Consequently, in this system, the recorder will be the master and the MIDI sequencer the slave.

- \* Restore the default settings on this recorder.
- \* Check for the correct program and proper sampling frequency.

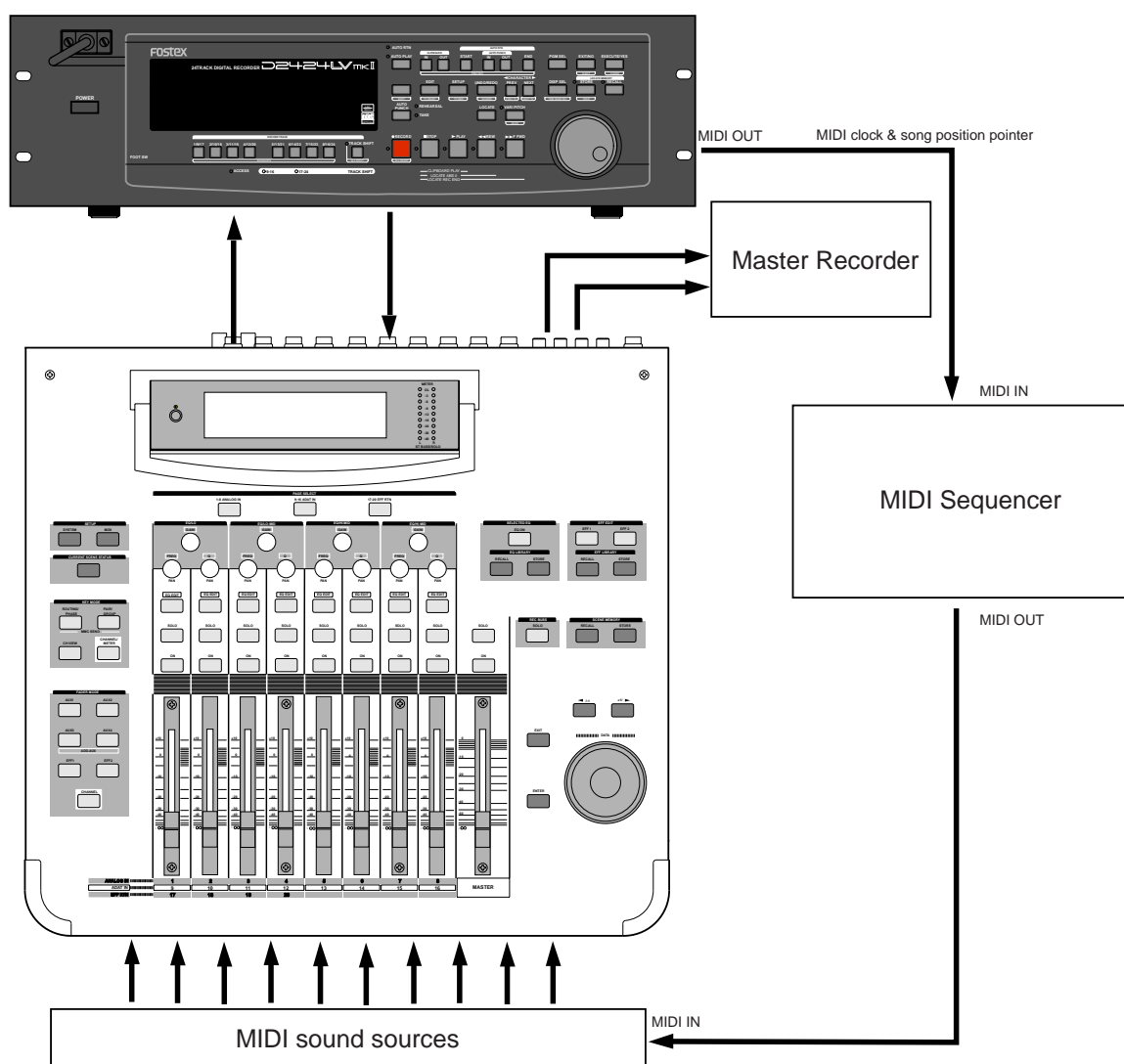

### • Connecting external equipment (Refer to connecting schematic)

- (1) Connect the unit [MIDI OUT] to [MIDI IN] of the MIDI sequencer.
- (2) Set the MIDI sequencer for “external sync mode (EXTERNAL SYNC) by MIDI clock.”

\* Refer to the Owners Manual of the equipment in use for details.



• **Setup of the D2424LVmkII**

- (1) **Because the MIDI clock and song position pointer will be output from the recorder, set the SETUP mode “Setting MIDI sync output signal” to “CLK.”**

\* Initial setting: **MTC**  
 \* Permissible setting: **CLK** (MIDI clock and song position pointer:”CLK”)  
**MTC** (MIDI time code: “MTC”)  
**Off** (No output of MIDI sync signal)  
 \* This item can be setup for each program.  
 \* The setting can be saved/loaded as song data.  
 \* This setting will be held even though power is switched OFF.

*Refer to page “114”, SETUP mode “Setting MIDI sync output signal” for correct operating procedures.*

- (2) **The meter in the desired bar can be set by “Time signature setting” of the SETUP mode.**

\* Initial setting: **001 bar, 4/4 signature.**  
 \* Permissible bar setting: **001-999**  
 \* Permissible meter setting: **1/4, 2/4, 3/4, 4/4, 5/4, 1/8, 3/8, 5/8, 6/8, 7/8, 8/8,**  
**— —** (Elimination of signature)  
 \* Permissible setting of maximum number of points: **64 points**  
 \* This item can be set for each program.  
 \* The setting can be saved/loaded as song data.  
 \* This setting will be held even though power is switched OFF.

*Refer to page “110”, SETUP mode “Time Signature Setting” for operating procedure.*

- (3) **Tempo in the desired bar can be set by “Tempo setting” of the SETUP mode. Tempo map is made in steps 2 and 3.**

\* Initial setting: **001 bar, 1st meter, Tempo120.**  
 \* Permissible bar setting: Follows the previous “Setup of the time signature.”  
 \* Permissible signature setting: Follows the previous “Setup of the time signature.”  
 \* Permissible setting of tempo: **Quarter note=30~250 ....** (Tempo elimination)  
 \* Permissible setting of maximum number of points: **64 points**  
 \* This item can be set for each program.  
 \* The setting can be saved/loaded as song data.  
 \* This setting will be held even though power is switched OFF.

*Refer to page “112”, SETUP mode “Setting a tempo” for operating procedure.*

- (4) **Set the SETUP mode “Metronome setting” to ON if click sound is to be output according to the setup tempo map.**

\* Initial setting: **Off**  
 \* Permissible setup item: **Off, On**  
 \* This item can be set for each program.  
 \* The setting can be saved/loaded as song data.  
 \* This setting will be held even though power is switched OFF.

*Refer to page “113”, SETUP mode “Setting the Metronome function” for operating procedure.*

- (5) **Press the [DISP SEL] key while holding down the [SHIFT] key, and then change the time base display to BAR/BEAT/CLK.**

• **Confirming the MIDI clock sync**

During recording and at playback following the recording, the time base (BAR/BEAT/CLK) is displayed in accordance to the setup tempo map, and the MIDI clock and song position pointer is also output.

Confirm that the travel position (BAR/BEAT/CLK) of the recorder and the travel position of the synchronized MIDI sequencer are matched.

\* If correct sync cannot be obtained, re-check the connections/cables and setting of both equipment.

**<Note>**: In the recorder, the “ABS 0” position is set at “-002BAR/1BEAT /00CLK.”  
 This setting is made in consideration of the time required (it will not sync immediately) for the MIDI sequencer, etc. to enter into sync. As a result, if the recorder is played back from ABS 0 (LOCATE ABS 0), sync will be completed by the time it reaches the first bar, and will thus synchronize from head of the tune.

• Execution of recording

Various ways of recording can be conducted while synchronizing the recorder and the MIDI sequencer with the MIDI clock.

**MTC sync/MIDI machine control system**

The following will explain synchronization by the MTC (MIDI time code) output and the computer controlling system using MMC (MIDI machine control). In this system, the recorder will be the master and the computer (with sequence software) will be the slave. The recorder will attach any desired offset (time difference) against ABS time (absolute time) and output it as MTC in any desired frame rate. It can also carry out the proper operation upon receiving an MMC and Fostex System Exclusive Message from outside. In this case, because the recorder can setup a DEVICE ID number by the SETUP mode “MIDI Device ID Setting” menu, a multiple number of the unit’s can be separately controlled by changing the DEVICE ID numbers in the transmitted message from the computer. In regards to the corresponding content for MMC, refer to the “**MMC list**” on page “129” and on the Fostex System Exclusive Message, the “**Fostex Exclusive List**” on page “130.”

\* Set the recorder in the initial state.  
 \* Confirm the program and sampling frequency.

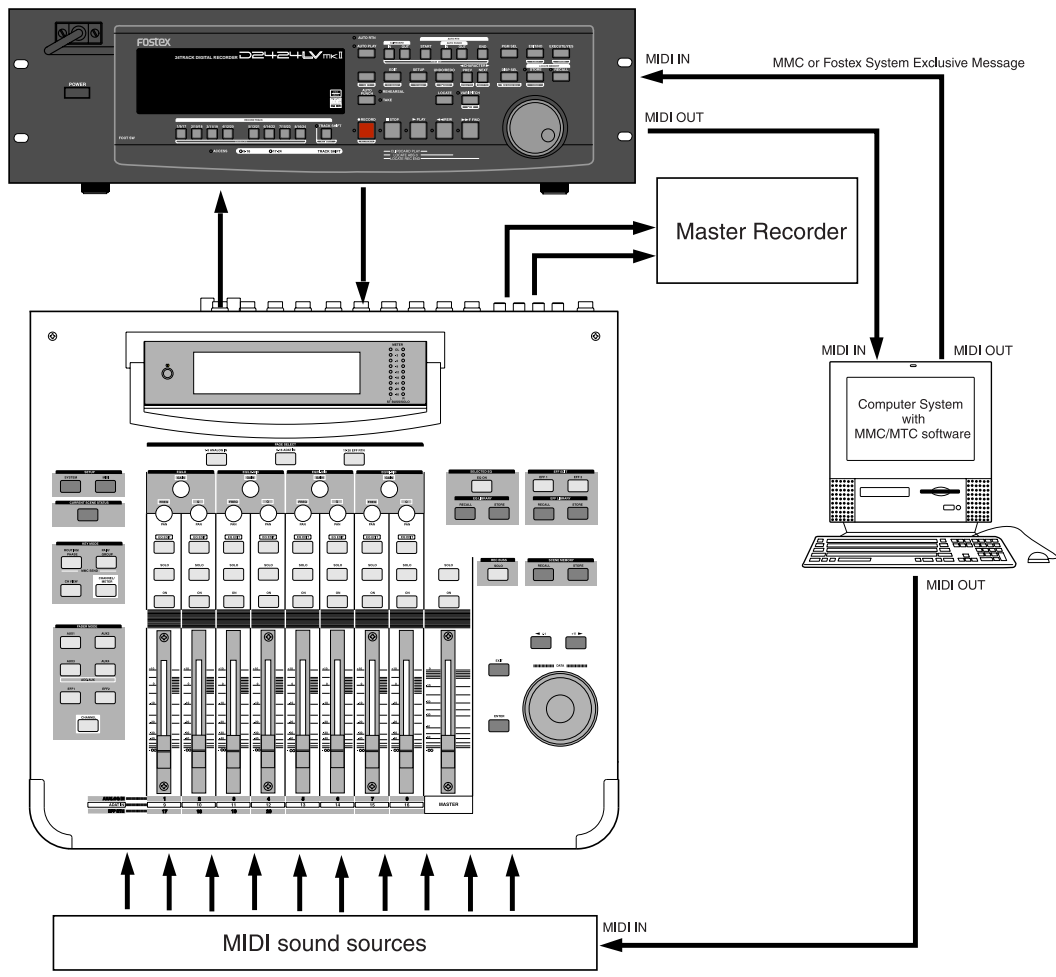

## • Connecting to external equipment

Connect the recorder MIDI IN/OUT to the computer (with MIDI interface) MIDI IN/OUT (MMC/MTC complied sequence software is activated in the computer).

## • Setup of external equipment

Setup the following in the sequence software.

\* Set to MTC external sync mode (EXTERNAL SYNC).  
 \* Set for output of MMC.  
 \* Set to the desired MTC read out frame rate.  
 \* Set start time of the tune (which MTC time is to be the first bar). Refer to precaution in regards to MTC offset, farther on.

*For details, refer to Owners Manual of the external equipment.*

## • Setup of the D2424LVmkII

- (1) Because MTC will be output from the recorder, set to "MTC" the SETUP mode "Setting MIDI sync output signal."

*Refer to page "114", SETUP mode "Setting MIDI sync output signal" for operating procedure.*

- (2) Set a random offset time by the SETUP mode "Setting an MTC offset value."

\* Initial setting:                                   **00H (Hour) 59M (Minute) 57S (Second) 00F (Frame) 00SF (Sub Frame)**  
 \* Permissible setup time:                   **00H 00M 00S 00F 00SF ~ 23H 59M 59S 29F 99SF**  
 \* This item can be set for each program.  
 \* The setting can be saved/loaded as song data.  
 \* This setting will be held even though power is switched OFF.

*Refer to page "115", SETUP mode "Setting an MTC offset value" for operating procedure.*

- (3) In the SETUP mode "Setting Offset mode," whether the MTC offset time setup in Step 2 should be output (ABS) at the ABS 00M 00S 00F 00SF position or at the 001BAR 1BEAT 00CLK (bar, signature) must be selected.

\* Initial setting:                                   **ABS**  
 \* Permissible setup item:                   **ABS, Bar Beat**  
 \* This item can be setup for each program.  
 \* The setting can be saved/loaded as song data.  
 \* This setting will be held even though power is switched OFF.

*Refer to page "115", SETUP mode "Setting Offset mode" for operating procedure.*

- (4) Setup to the same frame rate as that setup by the sequence software by "Setting an MTC frame rate" of the SETUP mode.

\* Initial setting:                                   **25 frames**  
 \* Permissible setup of frame rate:       **24, 25, 29.97nd, 29.97df, 30nd, 30df**  
 \* This item can be setup for each program.  
 \* The setting can be saved/loaded as song data.  
 \* This setting will be held even though power is switched OFF.

*Refer to page "114", SETUP mode "Setting an MTC frame rate" for operating procedure and details.*

- (5) Set to the same figure as the sequence software MMC device number (and Fostex System Exclusive Message device number) by the SETUP mode "Setting the MIDI device number."  
 When the sequence software transmits by "7F," it means "ALL DEVICE" and therefore, it need not be setup.

- \* Initial setting: **00**
- \* Permissible setup ID: **00 ~ 99**
- \* This item will be the setting common to all programs.
- \* This setting cannot be saved/loaded as song data.
- \* This setting will be held even though power is switched OFF.

Refer to page "120", SETUP mode "Setting the MIDI device number" for operating procedure and details.

- (6) Press the [DISP SEL] key while holding down the [SHIFT] key to show time base in the MTC display.

**<Notes on MTC related setups>**

By "MTC offset time setting" and "MTC offset mode setting," at what position (ABS 0 or 001BAR/1BEAT/00CLK) should the setup MTC (MTC offset time) is to be output is set. When setting the start time of the tune in the sequence software by these setups, be careful of the following points.

• **Offset mode: For ABS**

If playback is started from ABS 0, since MTC will be output starting from the MTC offset time that has been set, the start time of the tune set by the sequence software must be set about 3 seconds later from the MTC offset time that was setup. This will provide time because the sequence software cannot sync immediately after MTC is output. For example, if the initial setting of "00H 59M 57S 00F 00SF" is used, set the start time of the tune to "01H 00M 00S 00F."

If playback is thus started from ABS 0 (LOCATE ABS 0), sync will be obtained by the time it reaches the first bar and therefore it can be made to sync from the head of the tune.

• **Offset mode: For BAR BEAT**

As mentioned before, because the "ABS 0" position is set at the "002BAR / 1BEAT / 00CLK" position, the setup MTC offset time can be set to the head of the tune without taking into account the time until reaching sync, as mentioned above. The length of the time two bars beforehand will change in accordance to the first bar setting for "signature" and "tempo." For example, it will be long if the tempo is set slow. This mode can be effectively applied when using the MIDI clock and MTC in parallel, and when using MTC for the sync signal while controlling the recorder with time base BAR/BEAT/CLK.

• **Confirming MTC sync/MMC**

- (1) **During recording and at playback after recording, time base MTC is displayed according to the setting and MTC is output at the same time.**

Check that the recorder traveling position (MTC) and the traveling position of the sequence software in sync are matched.

- (2) **Send MMC commands such as PLAY, STOP and LOCATE from the sequence software to see that the recorder will be properly controlled.**

When a correct MIDI command (MMC or FEX) is received, "MIDI" in the display will be lit for about 40msec. There is no setting in the recorder to receive MMC or FEX but it will operate if a correct MIDI signal is input.

\* If sync and control cannot be done correctly, re-check connections/cables and the setting of both equipment.

• **Execution of recording**

Carry out various recordings while synchronizing the recorder and a MIDI sequencer with the MIDI clock.

### Multitrack system by the slave mode

An example of how to make a multitrack system by interconnecting three recorders in a slave mode function, will be explained in the following.

- \* Initialize the recorder.
- \* Confirm the program.
- \* Set all three recorder's to the same sampling frequency.

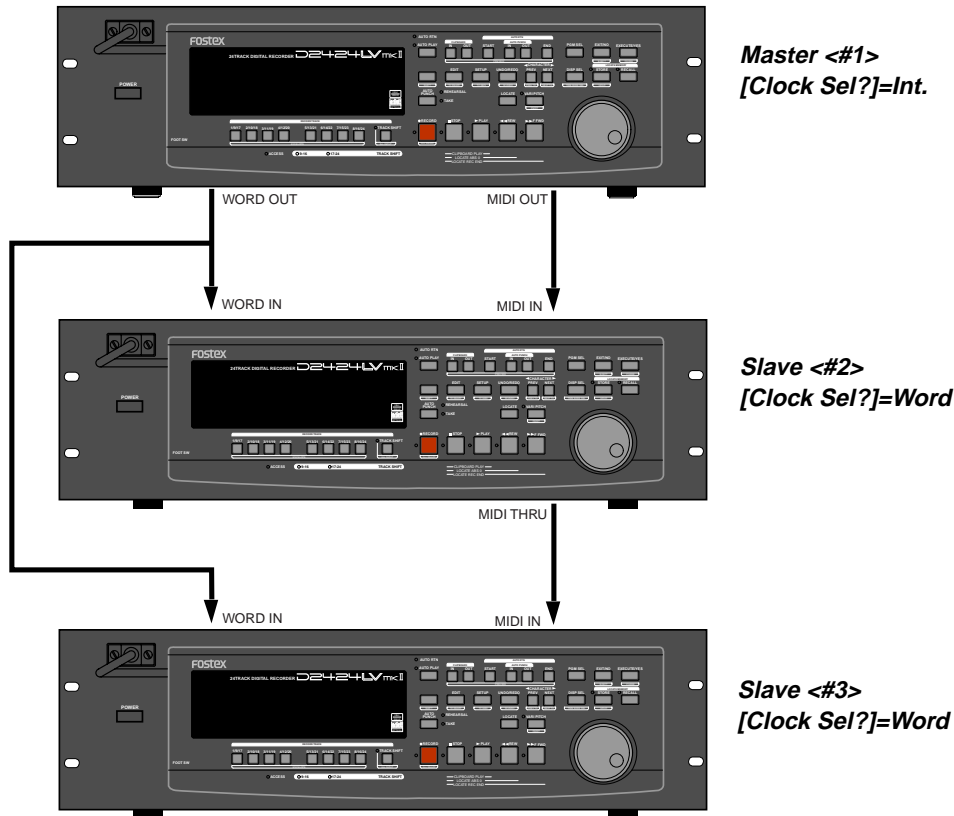

#### • Equipment interconnections

- (1) From the recorder (#1) to the recorder (#2), connect WORD OUT to WORD IN and MIDI OUT to MIDI IN.
- (2) From the recorder (#1) to the recorder (#3), connect WORD OUT to WORD IN.
- (3) From the recorder (#2) to the recorder (#3), connect MIDI THRU (Note!!!) to MIDI IN.

#### <Notes>

- \* In order to slave drive the recorder with each other, the best setting is to supply word clock signals together with MTC from the master.
- \* As shown in the above schematic, at input or the Word Clock from the master to the second slave, WORD OUT from the master must always be branched to the second slave. Do not connect the first slave WORD OUT to the second slave WORD IN.

#### • Setup of the recorder (#1): <Master>

- (1) Because MTC, which is the reference for sync, is output from the recorder (#1), set the “Setting MIDI sync output signal” of the SETUP mode to “MTC.”

Refer to page “114”, SETUP mode “Setting MIDI sync output signal” for operating procedure and details.

- (2) A random frame rate to be used is set by the SETUP mode “Setting an MTC frame rate.”

Refer to page “114”, SETUP mode “Setting an MTC frame rate” for operating procedure and details.

- (3) With the SETUP mode “Setting Offset mode,” whether the MTC offset time will be output (ABS) at the ABS 00H 00M 00S 00F 00SF point or at the 001BAR 1BEAT 00CLK (bar/signature) point of the tempo map, is selected.

*Refer to page “115”, SETUP mode “Setting Offset mode” for operating procedure and details.*

- (4) A random offset time is set by the SETUP mode “Setting an MTC offset value.”

*Refer to page “115”, SETUP mode “Setting an MTC offset value” for operating procedure and details.*

- (5) “00” is set with the SETUP mode “Setting the MIDI device number.”

*Refer to page “120”, SETUP mode “Setting the MIDI device number” for operating procedure and details.*

- (6) Set to “Int.” the clock setting by the SETUP mode “Setting the operating clock.”

*Refer to page “120”, SETUP mode “Setting the operating clock” for operating procedure and details.*

- (7) Press the [DISP SEL] key while holding down the [SHIFT] key to change the time base display to MTC.

• Setup of the recorder (#2) <Slave 1> and (#3) <Slave 2>

- (1) Set the SETUP mode “Setting an MTC frame rate” to the same frame rate as in the recorder (#1).

*Refer to page “114”, SETUP mode “Setting an MTC frame rate” for operating procedure and details.*

- (2) Set the SETUP mode “Setting Offset mode” to the same mode as in the recorder (#1).

*Refer to page “115”, SETUP mode “Setting Offset mode” for operating procedure and details.*

- (3) Set the SETUP mode “Setting an MTC offset value” to the same offset time as in the recorder (#1).

*Refer to page “115”, SETUP mode “Setting an MTC offset value” for operating procedure and details.*

- (4) Set the SETUP mode “Setting the MIDI device number,” to “01” in the recorder (#2), and to “02” in the recorder (#3).

*Refer to page “120”, SETUP mode “Setting the MIDI device number” for operating procedure and details.*

- (5) Press the [EXECUTE/YES] key While holding down the [SHIFT] key, set slave mode to “On.” “CHASE” indicator will be flashing in the display.

- (6) Using the SETUP mode “Setting the slave type,” set slave type to “Free.”

\* Slave type initial setting:                      Vari  
 \* Permissible setup item:                      Vari, Free, Once  
 \* This item can be set for each program.  
 \* The setting can be saved/loaded as song data.  
 \* This setting will be held even though power is switched OFF.

*Refer to page “116”, SETUP mode “Setting the slave type”, for operating procedure and details.*

- (7) Set to “Word” the clock setting by the SETUP mode “Setting the operating clock.”

*Refer to page “120”, SETUP mode “Setting the operating clock” for operating procedure and details.*

- (8) Press the [DISP SEL] key while holding down the [SHIFT] key, to change the time base display to MTC.

**<Notes>**  
 After this setup, check the following in the recorder (#2) and (#3).

- *Blinking of “CHASE” in the display: This will change to constant lit upon completing chase lock in later operation.*
- *“EXT” and “WORD” are lit in the display: This means it is externally synchronized against the input word clock signal.*

**• Check chase lock**

---

- (1) **When the master recorder (#1) is played back, MTC IN LED of the slave recorder (#2) and (#3) will be lit, “CHASE” in the display will immediately change from blinking to lit and chase lock will be completed.**  
 Check that the MTC time on display are same in both master and slave units.
- (2) **When the master starts recording, the slave will also start recording upon completing chase lock.**
- (3) **When the master is stopped, the slave will also stop as MTC from the master will be interrupted.**  
 “CHASE” in the display will change from lit to blinking.
- (4) **During FF/REW, the master only will be in the FF/REW mode and the slaves will remain stopped but when playback/recording is started, the slaves will immediately chase lock.**

**<Note>**: *The unit re-chase window is fixed at “10 frame.” In other words, when MTC of the master and slave drifts apart more than 10 frames, it will assume that chase lock is disengaged and the slave will match the position again with the master (re-chase operation). During the re-chase operation, sound output will be muted. If the drift is within 10 frames, the slave will recognize this and continue to travel. Because the master supplies digital signal to slave in this system, re-chase is rarely carried out following chase lock.*

\* Should the unit fail to correctly chase lock and control, re-check the connection /cables and all settings.

**• Execution of recording**

---

A variety of recording work can be carried out with all three recorder’s in the chase lock mode.

## External MIDI equipment sync system by the slave mode

Up to this point, synchronization with external MIDI equipment has been explained with the recorder as the master and MIDI equipment as the slave but depending on the slave mode setting, the MIDI equipment can be set as the master and the recorder as the slave.

**<Note>**: External MIDI equipment which can be used as the master is limited to those which can output MTC.

- \* Initialize the recorder.
- \* Confirm the program and sampling frequency.
- \* In the following, the explanation will be on the assumption that a computer (with sequence software) is used.

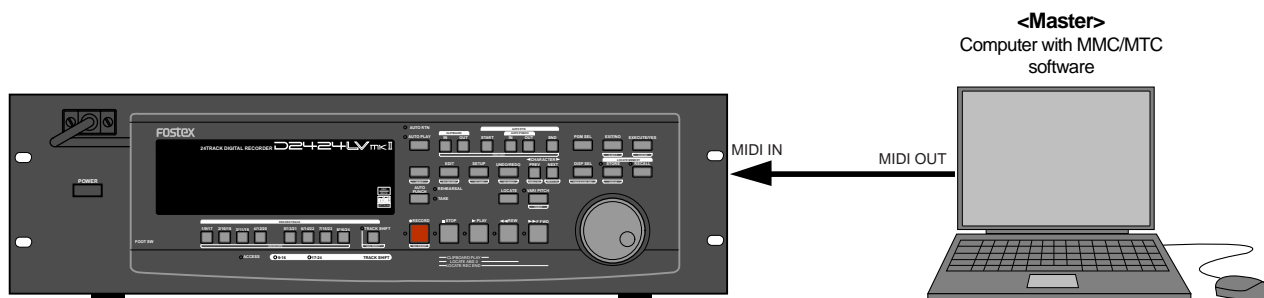

### • Connection to external equipment

Connect MIDI OUT of the computer (with MIDI interface) with MIDI IN of the recorder. The computer sequence software complying to MMC/MTC must be activated.

### • Setup of external equipment

Sequence software is setup as follows.

- \* Set for output of MTC.
- \* Set frame rate of the MTC to be output.
- \* Confirm start time of the tune.

*Refer to Owners Manual of the respective equipment for details.*

### • Setup of the D2424LVmkII

- (1) Set to same frame rate as the sequence software by the SETUP mode "Setting an MTC frame rate."

*Refer to page "114", SETUP mode "Setting an MTC frame rate" for operating procedure and details.*

- (2) Set to the desired mode by the SETUP mode "Setting offset mode."

*Refer to page "115", SETUP mode "Setting offset mode" for operating procedure and details.*

- (3) A random offset time can be set by the SETUP mode "Setting an MTC offset value."

*Refer to page "115", SETUP mode "Setting an MTC offset value" for operating procedure and details.*

- (4) Press the [EXECUTE/YES] key holding down the [SHIFT] key, set the slave mode to "On."

- (5) Set slave type to "Vari" by the SETUP mode "Setting the slave type."

*Refer to page "116", SETUP mode "Setting the slave type" for operating procedure and details.*



- (6) Press the [DISP SEL] key while holding down the [SHIFT] key, to change the time base display to MTC.

**<Precautions at MTC related setups>**

The position (ABS 0 or 001BAR/1BEAT/00CLK) when the setup MTC (MTC offset time) should be output was setup by the "MTC offset time setting" and "MTC offset mode setting." In accordance to start time of the tune set by the sequence software, setup as explained below.

**Offset mode: For ABS**

Set the MTC offset time about three seconds prior to the start time of the tune set by the sequence software. Because the recorder cannot immediately chase lock after input of MTC, in order to sync the unit from head of the tune, set the preroll using the sequence software, and playback from before the actual head of the tune to allow the recorder to enter into sync by the time it arrives at the head of the tune.

**Offset mode: For BAR/BEAT**

The MTC offset time can be set to the same time as the start time of the tune set by the sequence software. Because the "ABS 0" position is set at the "002BAR/1BEAT/00CLK" position in the unit, as mentioned before, the preceding time required for sync is already set. The preceding time of two bar lengths could change in length depending on the first bar's "signature setting" and "tempo setting" mentioned before. For example, it will be longer if the tempo is slowed down.

**• Confirming chase lock**

- (1) When the sequence software is played, MTC IN LED of the recorder will light, "CHASE" in the display will change from blinking to lit and the chase lock will be completed.  
Check that the MTC output by the sequence software and MTC time displayed in the recorder are the same.
- (2) When the sequence software stops, MTC will be interrupted and the recorder will also stop.  
"CHASE" in the display will change from lit to blinking.
- (3) During FF/REW of the sequence software, the recorder will remain stopped but upon starting to record, the recorder will immediately chase lock.

**<Note>**: Chase lock of the recorder by MTC only is permissible when speed difference of the MTC from the master is within +/- 5.6%. Against the MTC within this range, variable pitch will be constantly applied internally for chasing. Chase lock, however, will not function against MTC at a speed difference outside this range. Also, when the master speed difference is large, it is advised to let the recorder learn the master speed by entering PLAY prior to recording. By doing so, it will be lock faster from the second and later sessions.

\* Should it not be possible to chase lock, re-check connections / cables and all settings.

**• Execution of recording**

Carry out various recordings while the recorder is chase locked to the sequence software.

**<One Point Advice>**

Sync signal "Free" of the "Slave mode setting" menu:

When the recorder is made to chase lock by MTC only, variable pitch will be constantly applied by external MTC. If a digital signal is output to an external digital equipment from the recorder, it will not be able to follow the speed difference (MTC speed difference of the master) of the recorder and the external digital equipment, in some cases, may not be able to input a continuous digital signal. As a counter measure, the sync signal should be set to "Free" by the "Slave mode setting" menu. Using this setting, the recorder will enter self operation by the internal clock, after completion of chase lock, and it will be possible to supply a stable digital signal to the external equipment.

Under this setting, when MTC drift between the master recorder and slave recorder exceeds 10 frames, the recorder will assume that chase lock has been disengaged and the slave recorder will carry out position matching again with the master unit (re-chase operation). During the re-chase operation, sound output will be muted and the digital signal will also be interrupted. If it is within 10 frames, the slave recorder will continue to run while admitting this drift.

# Saving and Loading Song Data

The unit allows you to save song data of a selected program (audio data + setup data) to an external audio recorder (DAT, adat, etc.) or a CompactFlash™ card (in the FDMS-3 Ver.3.0 format). The saved song data can be loaded to the unit. By temporarily saving data of a finished or unfinished song to an external medium you can load it to the unit later for editing, additional recording, etc. You can also save a song to a DOS formatted CompactFlash™ card as a WAV file, which also can be edited using a computer.

Furthermore, by installing the optional E-IDE hard disk instead of the pre-installed CF drive, you can save song data to the hard disk in the FDMS-3 Ver.3.0 or WAV format. (To install the optional E-IDE hard disk, the optional Model 9044 (bay + caddy) must be mounted.)

**\*\*\*\*\*About saved and loaded data\*\*\*\*\***

The data format and time required to SAVE/LOAD song data will vary between saving and loading with a DAT using S/P DIF digital signals, saving and loading with an adat device using adat digital signals, or saving and loading with a CompactFlash™ card (or a optional E-IDE hard disk drive).

**S/PDIF digital signal (You can save and load each Program individually.):**

Following about five seconds of pilot signal (shown in the diagram below), song data in the current drive is output to a connected DAT. Two tracks of audio data (shown in black in the diagram) are output. To save data from Real tracks 1-24, two-track data will be output twelve times, which takes twelve as much time as the song duration (ABS 0 to REC END). To save all data including Additional tracks 1-56, two-track data will be output twenty eight times, which takes twenty eight times the song duration. Saved data is also loaded two tracks at a time.

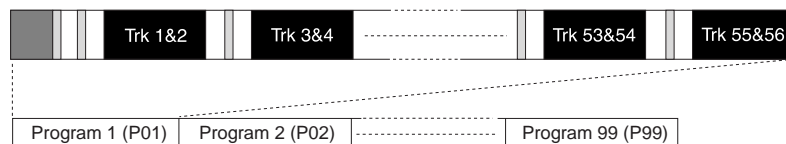

**adat digital signal (You can save and load each Program individually.):**

After about five seconds of pilot signal (shown in gray in the diagram below), song data in the current drive is output to a connected adat. Eight-track audio data (shown in black in the diagram) is output. To save the data from Real tracks 1-24, data will be output three times, which takes the same amount of time as the song duration (ABS 0 to REC END). To save all data including Additional tracks 1-56, eight-track data will be output seven times, which takes seven times the song duration. Saved data is also located eight tracks at a time.

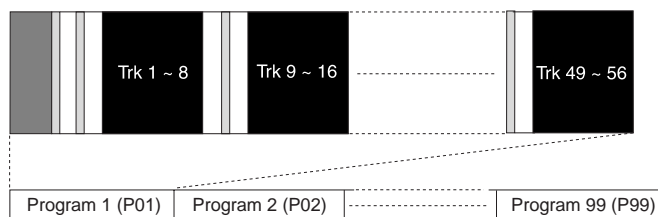

**CompactFlash™ card or optional E-IDE hard disk drive:**

**(You can save and load each Program individually or all program.)**

All Real track data and Additional track data is output simultaneously to a CompactFlash™ card (or optional E-IDE hard disk drive) as shown in black in the diagram. Therefore, saving and loading a Program takes much less time relative to a DAT or adat. No pilot signal or beep is recorded. You can also save/load WAV files in DOS formatted disk.

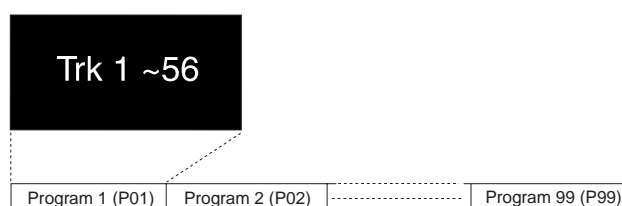

**<The following items can be saved and loaded as song data>**

Memory data: CLIPBOARD IN/OUT, AUTO RTN START/END, AUTO PUNCH IN/OUT point data  
 Locate data (locate number 00~99): when saving and loading song data using a CompactFlash™ card

Time Base: ABS, MTC, or BAR/BEAT/CLK

Setup mode: • Time signature setting (BAR BEAT), • Tempo setting, • Click On/Off setting  
 • Preroll Time setting, • Midi Sync Out setting, • MTC Frame Rate setting  
 • MTC Offset setting, • MTC Offset Mode setting, • Rec Protect On/Off setting  
 • Slave Mode on/off setting, • Slave Type setting, • Virtual TC Setting (when saving and loading song data using a CompactFlash™ card)

**<The following items cannot be saved or loaded as song data>**

Auto Play mode and Auto Return mode On/Off

Vari-pitch mode On/Off, and pitch data

Setup mode: • Digital In setting, • Digital Out setting, • Bar/Beat Resolution On/Off setting  
 • Device ID setting, • Foot switch function setting, • Mark stop function setting  
 • Auto EE mode setting, • Chain play mode setting and chain list  
 • Reference level setting, • Bal/Unbal setting, • Contrast level setting

**<Notes in using DAT and adat>**

- Execution of save/load is permissible only in 44.1kHz/16 bit, 44.1kHz/24 bit, 48kHz/16 bit or 48kHz/24 bit asynchronous recording in S/P DIF format, or with digital devices that have the adat format digital recording function.
- When a 24 bit data recorded in the recorder is saved to a 16 bit digital device, Audio 16 bit only will be saved. Also, when a 20 bit data is saved, Audio 20 bit only will be saved.
- When loading DAT or adat data, if it is 16 bit, even if the current drive of the recorder has been formatted in 24 bits, only the upper 16 bits will be loaded and the lower 8 bits will be "0." Likewise, in a 20 bit machine, the upper 20 bits only will be loaded and the lower 4 bits will be "0."

**<Note when saving data using DAT or adat>**

Song data can be saved as a real track, additional track or ALL data. Please note the following points when saving song data using a DAT or adat device.

The save time of the data depends on the time of the song data (ABS 0-REC END) on the real track. Therefore, if you attempt to save data that exists on an additional track that is longer than the data on the real track, the data on the additional track will only be saved for the same amount of time as the data on the real track.

Let's say, you have 10 minutes recorded on the real track and you tentatively move it to the additional track (track exchange function). Then you save a real track by leaving that moved portion blank, which leaves you with only 3 minutes of recording on the track. This means only 3 minutes of the data on the additional track will be saved, and the remaining 7 minutes will not be saved. If you want longer save time, you can edit the save time during save operations (Go to page "93" <Step-6>).

This can be done by either setting the save time to a longer save time (however, the maximum time that can be edited is 59 minutes 59 seconds), or move the data with the longest recording time on the additional track to the real track and then save that data. Be careful not to erase the data that you need on the additional track when conducting these procedures. For more details on track exchange go to page "77."

### Saving the data using an adat or S/P DIF digital signal

S/P DIF digital signal (or adat digital signal) from the **[DATA OUTPUT]** connector of the recorder is saved.

*\* Restore the initial settings on the recorder.  
\* Set the same sampling rate on the external digital device and the recorder.*

#### Connecting an external device

Connect **[DATA OUTPUT] 1-8** connector of the recorder to the digital input connector on the external digital device.

**<Notes>**

- The recorder has **[DATA OUTPUT]** connectors for an S/P DIF digital signal (OPTICAL) and for an adat digital signal. These connectors have the same shape but carry different information. Use the **[DATA OUTPUT] 1-8** connector to save data. Do not use the **[DATA OUTPUT] 9-16** and **17-24** connectors.
- Save/load by S/P DIF or adat digital signals cannot be executed from the current drive that is formatted in 96kHz/24 bit or 88.2kHz/24 bit.

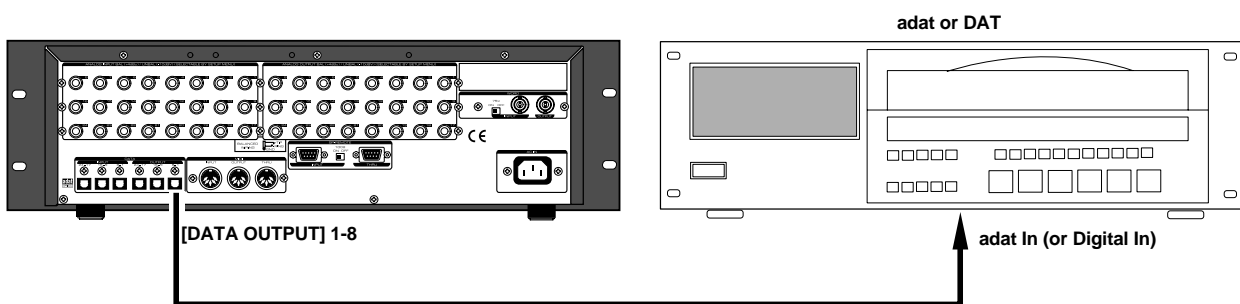

- If the external device has only COAXIAL type (RCA) digital I/O connectors, connect an optional COP-1/96k (optical/coaxial converter) to use an S/P DIF digital signal.
- Connecting both output and input connectors on the recorder to the input and output connectors on the external digital device respectively may generate a digital loop.

#### Setting up an external device

- (1) **Set the same sampling rate to that of the recorder.**
- (2) **Select digital input on the external device so that the external device will accept a digital signal.**  
On some external devices, you may have to set up so that the external device will synchronize with the incoming digital signal.

**<Note>**: If the external device does not accept the digital signal or if you notice digital noise, check the connection, cabling, and the settings of the recorder and the external device.

*\* Refer to the instruction manuals that came with any external digital device for details.*

#### Executing the save operation

Use the **“Save PGM?”** menu in Setup mode.

- Output format available : adat, SPDIF, IDE2 (CompactFlash™ card or E-IDE hard disk drive)
- Programs available : When using an adat/SPDIF -> P01 - P99 (each program individually)  
: When using a IDE2 -> P01 - P99 or All program
- Track available : When using an adat or DAT -> Tracks 1-8, 1-16, 1-24, 1-32, 1-40, 1-48, 1-56, 9-16, 9-24, 9-32, 9-40, 9-48, 9-56, 17-24, 17-32, 17-40, 17-48, 17-56, 25-32, 25-40, 25-48, 25-56, 33-40, 33-48, 33-56, 41-48, or 49-56  
: When using a IDE2 -> All tracks (1-56) will be automatically selected.

- (1) **Press the [SETUP] key.**  
The recorder enters Setup mode.
- (2) **Use the Jog dial to select "Save PGM?," and then press the [EXECUTE/YES] key.**  
The message "Save Device?" and an indication of the digital signal to be saved ("SPDIF," "adat," or "IDE2" ) will flash on the display.

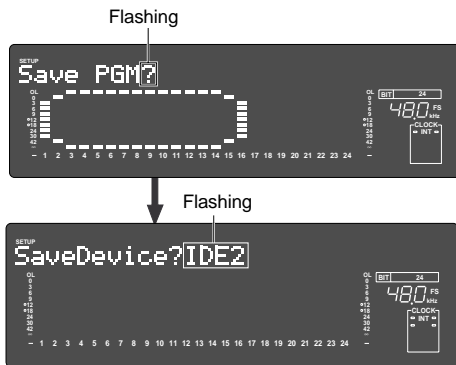

- (3) **Rotate the Jog dial to select a type of digital signal ("adat" or "SPDIF") format to be used for the save operation.**  
Selecting "adat" will save data in the adat digital signal format. Selecting "SPDIF" will save data in the S/P DIF digital signal format.
- (4) **Press the [EXECUTE/YES] key.**  
Selection of the digital signal format for the save operation will be confirmed, and the existing Program numbers will flash on the display.



- (5) **Rotate the Jog dial to select a Program to save.**  
You can select any existing Program (up to 99) to save.
- (6) **Press the [EXECUTE/YES] key.**  
The length of the time (ABS 0 - REC END) of the program recording selected appears and the time shown can be edited.  
The time is usually saved according to the time displayed, however, it is possible to shorten the time to save at this stage when saving the time. In other words, though the actual recording may be 9 minutes 00 seconds, as shown in the example below, that time can be edited to 5 minutes when saved. As mentioned in the <Note> on page 91, if the data on the additional track is longer the time can be set to a longer time and saved (however, the maximum time that can be edited is 59 minutes 59 seconds).



- (7) **Press the [EXECUTE/YES] key again.**  
"Save Trk ? 1-24" ("1" is flashing) appears on the display and you can select tracks to save.

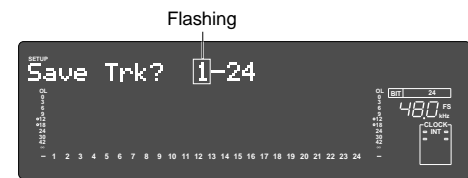

- (8) **Select the desired track range using the Jog dial.**  
You can select 1, 9, 17, 25, 33, 41, and 49 of the points that are flashing (left). Use the Shuttle dial to move the flashing cursor to the left, then turn the Jog dial to select 8, 16, 24, 32, 40, 48 and 56.

**<Note>:** Refer to the <Note> on page "91" prior to saving data including the additional track.

- (9) **Press the [EXECUTE/YES] key.**  
"Start Recorder !" (Start recording on the recorder) appears on the display, and "SURE?" flashes.

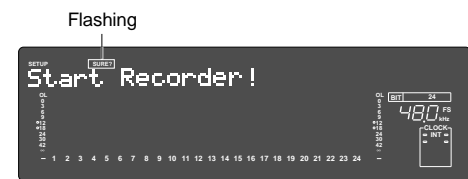

- (10) **Confirm that the external device is syncing with the digital input signal, and start recording on the external device (DAT or adat).**  
Setting a START-ID (DAT) or a locate point at the recording start point will facilitate future loading operations.
- (11) **Confirm that the recording on the external device has started, and press the [EXECUTE/YES] key.**  
The save operation starts, and the time required for the save operation appears on the display and a few seconds later, it will start counting down. This few seconds delay is due to the pilot signal which is recorded to mark the beginning of the Program to facilitate future load operation. Therefore, the actual save operation starts when counting down starts.  
Two tracks are saved each time in the order of Track 1 and 2, 3 and 4, etc. to a DAT machine. Eight tracks are saved each time in the order of Track 1-8, 9-16, etc. to an adat machine.
- (12) **When data is successfully saved a "COMPLETED!" message will appear on the display, and stop the external DAT or adat.**
- (13) **Press the [STOP] button or the [EXIT/NO] key to quit the Setup mode.**  
The display will return to the previous time base indication.

To cancel the operation or restore the indication shown before you pressed the [EXECUTE/YES] key, press the [STOP] button or the [EXIT/NO] key. Pressing one of these keys repeatedly takes you to the previous layer, finally quitting the Setup mode, and the display will return to the previous time base indication. If you press the [STOP] button or the [EXIT/NO] key any time after you execute the save operation but before it is complete, the saved song data will be invalid.

## Loading the data using a adat or S/P DIF digital signal

Load the data by S/P DIF digital signals (or adat digital signals) from the **[DATA INPUT]** connector of the recorder.

- \* Restore the initial settings on the recorder.
- \* Set the same sampling rate on the external digital device and the recorder.

### Connecting the external device

Connect **[DATA INPUT]** connectors of the recorder to the digital output connectors on the external digital device.

#### <Notes>

- The recorder has **[DATA INPUT]** connectors for an S/P DIF digital signal (OPTICAL) and for an adat digital signal. These connectors have the same shape but carry different information. Use the **[DATA INPUT] 1-8** connector. Do not use the **[DATA INPUT] 9-16** and **17-24** connectors.
- Do not remove the optical cable or perform any other operation that would disconnect the S/P DIF signal until the session is complete. Otherwise, the recorder will generate noise, and affect the connected device.

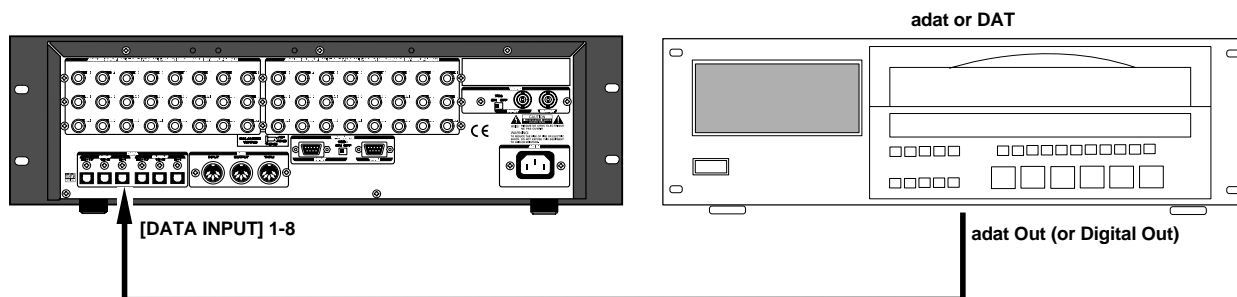

- If the external device has only COAXIAL type (RCA) digital I/O connectors, connect an optional COP-1/96k (optical/coaxial converter) to use an S/P DIF digital signal.
- Connecting both output and input connectors on the recorder to the input and output connectors on the external digital device respectively may generate a digital loop.

### Setting up an external device

- (1) Setup the external device so that it can output a digital signal.
- (2) Locate the beginning of the pilot signal recorded in the saved data.

\* Refer to the instruction manual that came with your external digital device for details.

### Executing the load operation

You will use the “**Load PGM ?**” menu in Setup mode.

- Output format available : adat, SPDIF, IDE2 (CompactFlash card™ or E-IDE hard disk drive)
- Programs available : When using an adat/SPDIF -> P01 - P99 (each program individually)  
: When using a IDE2 -> P01 - P99 or All program
- Track available : When using an adat or DAT -> Tracks 1-8, 1-16, 1-24, 1-32, 1-40, 1-48, 1-56, 9-16, 9-24, 9-32, 9-40, 9-48, 9-56, 17-24, 17-32, 17-40, 17-48, 17-56, 25-32, 25-40, 25-48, 25-56, 33-40, 33-48, 33-56, 41-48, or 49-56  
: When using a IDE2 -> All tracks (1-56) will be automatically selected.

- (1) **Press the [SETUP] key.**  
The recorder will enter the Setup mode.
- (2) **Use the Jog dial to select "Load PGM ?," and then press the [EXECUTE/YES] key.**  
The message "Load Device?" and the type of digital signal to be loaded ("SPDIF," "adat," or "IDE2") will flash on the display.

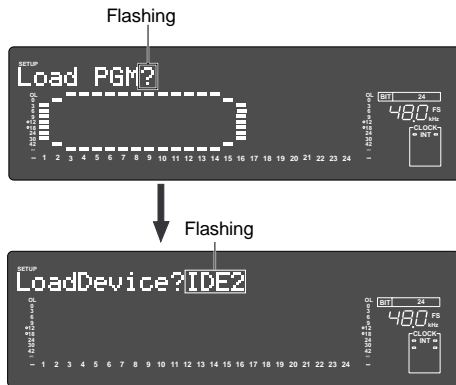

- (3) **Rotate the Jog dial to select the type of digital signal format ("SPDIF" or "adat") to be used for the load operation.**  
Selecting "adat" will load data in the adat digital signal format. Selecting "SPDIF" will load data in the S/P DIF digital signal format.
- (4) **Press the [EXECUTE/YES] key.**  
The digital signal selected is set and the program number currently set on the load destination current drive flashes. The size of the program recording is also displayed.



- (5) **Rotate the Jog dial to select a Program into which to load data.**  
You can select any existing Program (from up to 99).  
If you select a Program that already contains data and execute the load operation, the existing data will be overwritten by the new data.  
If you do not wish to overwrite any data in any current Program, use the Jog dial to select "New PGM" to execute the load operation.  
You can do this only when the number of existing Programs is 99 or less and the hard disk has enough free space to accommodate the new data.

*If a program that is already recorded with some sort of data is selected and loaded, only the song data loaded will be valid. All the data of the programs recorded on that same track up to then will be erased.*

- (6) **Press the [EXECUTE/YES] key.**  
Now you can select tracks into which to load.

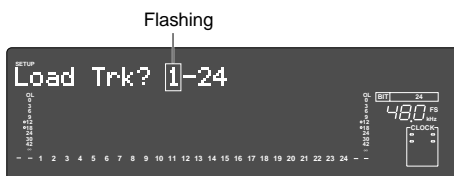

- (7) **Select the desired track range using the Jog dial.**  
You can select 1, 9, 17, 25, 33, 41 and 49 of the points that are flashing (left). Use the Shuttle dial to move the flashing cursor to the left, then turn the Jog dial to select 8, 16, 24, 32, 40, 48 and 56.
- (8) **Press the [EXECUTE/YES] key. ("SURE?" flashes.)**  
"EXT" and "DIGITAL" will light up and "SURE?" will flash in the display.



**<Notes>**

- If digital signal is being input correctly, a "DIGITAL" and "EXT" indicator will light up on the display.  
If the "DIGITAL" and "EXT" indicator flashes, check the connection, cabling, and the settings of the recorder and the external device.
- The FS indication will flash and warn you if the sampling frequency of the recorder and DAT vary when loading with S/P DIF digital signals. Be careful when setting the sampling frequency for adat digital signals because there will be no FS warning though there may be a discrepancy.

- (9) **Press the [EXECUTE/YES] key again.**  
"Start Player !" (Start playing the recorder) appears on the display.



- (10) **Play the corresponding external device (DAT or adat).**  
The load operation starts when the recorder accepts the incoming digital signal. The time required for the load operation appears on the display and starts counting down.

Two tracks are loaded at a time from a DAT machine in the following order: Track 1 and 2, 3 and 4, etc. from a DAT machine. Eight tracks are loaded each time in the order of Track 1-8, 9-16, etc..

- (11) **When the load operation is complete, "COMPLETED!" flashes on the display.**
- (12) **Press the [STOP] button or the [EXIT/NO] key to quit Setup mode.**  
The display will indicate the time base set for the loaded Program.

*Press the [STOP] button or [EXIT/NO] key to return to one previous menu prior to the [EXECUTE/YES] key or if you want to cancel a procedure. Every time you press these keys you will move back one previous hierarchy, and eventually escape from the SETUP mode and return to the time base display. Note that all the song data loaded will be invalid if you press the [STOP] button or [EXIT/NO] key while loading at <Step-10>.*



**Saving and Loading using a CompactFlash™ card or optional E-IDE Hard disk drive**

Using the pre-installed CF drive or optional E-IDE hard disk drive, you can save or load FDMS-3 (Fostex Disk Management System-3) files and WAV (RIFF WAVE) files. If you save program data in the WAV format, you can not only load it to the unit later but also can play it back or edit it using your computer (plus, the unit can use a WAV file which is edited by a computer).

- <Precautions>**
- A backup medium (CompactFlash™ card or E-IDE hard disk) must be formatted in either of the backup mode for handling FDMS-3 files or the DOS format mode for handling WAV files. So, according to your environment, format the medium appropriately before using. For details about how to format a backup medium (CompactFlash™ card or E-IDE hard disk), see "Formatting a backup medium (CompactFlash card or optional E-IDE hard disk)" on page 33.
  - The optional E-IDE hard disk drive should be installed by an authorized person. Contact your local Fostex dealer or service station for details. (The pre-installed CF drive is replaced with the E-IDE hard disk drive.)

**Saving in FDMS-3 Ver3.0 format**

By using a CompactFlash™ card (or E-IDE hard disk) which is formatted to "16bit Backup" or "24bit Backup" mode, you can save data in FDMS-3 Ver3.0 format. The procedure below shows how to save data to an unused, formatted CompactFlash™ card. (You can save data to the E-IDE hard disk in the similar manner.)

- (1) **Press the [SETUP] key when the equipment is stopped.**  
Go to the SETUP mode.
- (2) **Turn the Jog dial to select "SavePGM?" ("?" flashing). Then press the [EXECUTE/YES] key.**  
The menu to select the device to save the program on appears. "IDE2" flashes in the default mode.

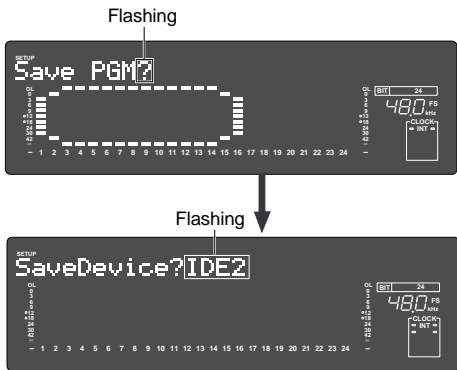

- (3) **Press the [EXECUTE/YES] key while "IDE2" is flashing.**  
A menu appears so you can select the program that you want to save. The currently selected program number flashes. The size of the program also appears.

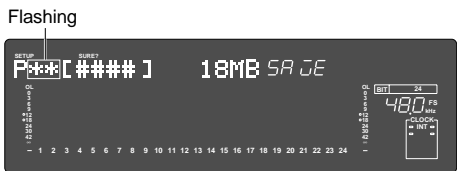

Turn the **Jog** dial in this state to select individual programs or select "Save All" (\*\*/\*\*).

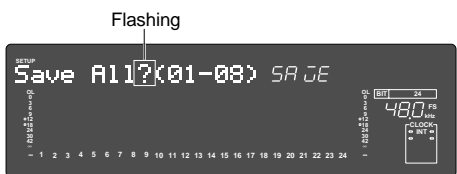

- (4) **Press the [EXECUTE/YES] key to select the program that you want to save.**

**<Selecting an individual program>**

If you select an individual program and press the [EXECUTE/YES] key, the display shows "B01 [New PGM]". This indicates that a new program is created to an unused medium.



**<Note>:** If any saved program data exists on a medium (CF card or E-IDE hard disk), you can select a desired existing program or [New PGM] from the list using the jog dial. In the following example, "B01" exists on the medium and the program newly created is "B02".



The selected program data is saved to the new program.



The selected program data is saved to the existing program.

When you select an existing program and perform program data saving, the new data overwrites the existing data. If you do not overwrite the existing data, select "[New PGM]".



**<Selecting all (or multiple) programs>**

If you select "Save All (01-08)" and press the [EXECUTE/YES] key, the display shows as below and you can now select the range of the programs to be saved. The first program number is flashing. In this example, eight programs are recorded on the current drive.

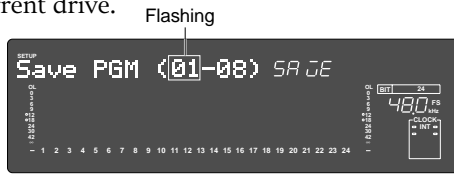

If you want to save all program data, simply press the [EXECUTE/YES] key when the display shows as above. To save multiple programs, specify the range of programs and press the [EXECUTE/YES] key, as described below.

**Example: Saving programs 01 through 04**  
 Rotate the shuttle dial clockwise to flash "08" and use the jog dial to enter "04".

**Example: Saving programs 03 through 06**  
 When "01" is flashing, use the jog dial to enter "03". Then rotate the shuttle dial clockwise to flash "08" and use the jog dial to enter "06".

- (5) **Select either "New PGM" or an existing program number. Then press the [EXECUTE/YES] key.**  
 The save process starts. The REMAIN counter (size to save) starts counting down. (The following is an example of saving data to backup number "B01".)

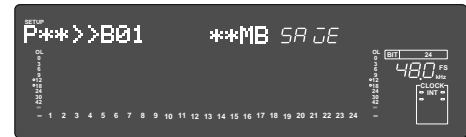

When the data is saved "COMPLETED!" lights up on the display. Then the system escapes from the SETUP mode.

**Loading an FDMS-3 file**

You can load FDMS-3 program backup data saved on a CompactFlash™ card (or E-IDE hard disk). In the following procedure, it is assumed that a CompactFlash™ card which contains backup program data is set to the CF drive.

- (1) **Press the [SETUP] key while in the initial menu, to go to the SETUP mode.**
- (2) **Turn the Jog dial to select "Load PGM?" ("?" flashes). Then press the [EXECUTE/YES] key.**  
 The menu to select the loading device appears. "IDE2" is the default setting and the indication flashes.
- (4) **Select a program (or programs) to be loaded, and press the [EXECUTE/YES] key.**  
 You can select a program (or programs) in the similar manner as selecting a program (or programs) to be saved. See step (4) of "Saving in FDMS-3 Ver3.0 format" above for details about how to select a program (or programs).

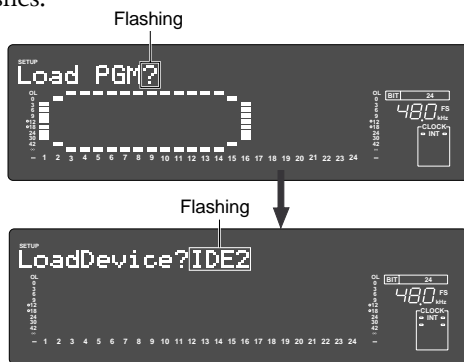

- (3) **Press the [EXECUTE/YES] key while "IDE2" is flashing.**  
 You can now select programs to be loaded.



By rotating the jog dial, you can select an individual backup program, as well as "Load All? (\*\*-\*\*) which allows you to select multiple programs.

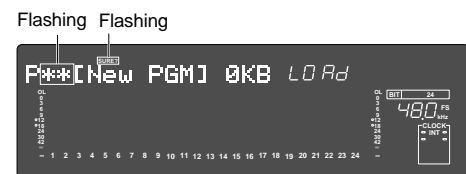
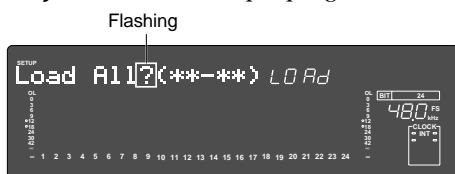

After pressing the [EXECUTE/YES] key, the display shows as below and you can now select the load destination program. By default, "[New PGM]" is shown. This option creates a new program for load destination.

By rotating the jog dial, you can select an existing program besides "[New PGM]". If you select an existing program and press the [EXECUTE/YES] key, the existing program data is overwritten by the loaded data. If you do not want to overwrite an existing data, select "[New PGM]".

- (5) **Select the load destination program. Then press the [EXECUTE/YES] key.**  
 Start loading to the load destination program that you selected. "COMPLETED!" lights up after successfully loading, and the mode escapes from the SETUP mode.



### Save function in FAT 16

The following procedure shows how to save a program to a FAT16 DOS formatted CompactFlash™ card as a WAV file. It is assumed that a FAT16 formatted unused CompactFlash™ card is set to the CF drive.

- (1) **The SETUP mode is entered by pressing the [SETUP] key.**
- (2) **Select "Save PGM?" ("?" flashes) with the Jog dial and press the [EXECUTE/YES] key.**  
The currently setup content will flash in the display.

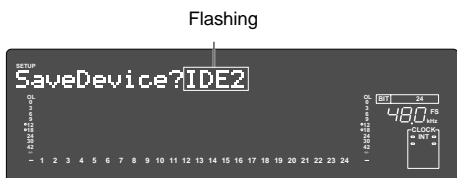

- (3) **Press the [EXECUTE/YES] key while "IDE2" is flashing.**  
The display will change to "CB Export? OFF" ("OFF" flashes) and ON-OFF of the clip board export can be setup.

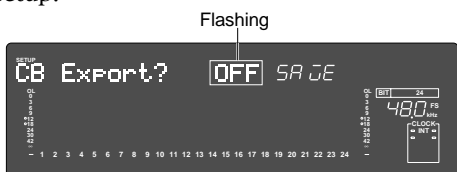

Normally, when saving ABS 0-REC END data, proceed to the next step while the setup is OFF. But, under the following condition, save is executed with the setup ON.

**< Please remember! >**  
When clip board export is set to ON, save is to be executed only on data within a desired range. In such a case, the desired range must be registered by the CLIPBOARD IN and CLIPBOARD OUT points previous to executing save. For explanation on registering of CLIPBOARD IN/OUT points, refer to "Registering of the locate point (=editing point)" on page 54.

- (4) **Select "OFF" and press the [EXECUTE/YES] key.**  
The display will change to selecting the program for saving.

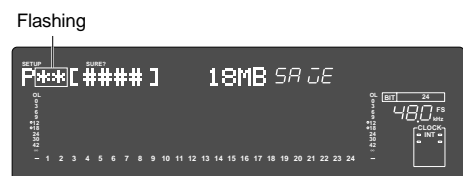

- (5) **Select the desired program with the Jog dial and press the [EXECUTE/YES] key.**  
The display will change to selecting the track to be saved. In the initial state, "All Trk" will flashes.



If the Jog dial is rotated at this stage, in addition to "All Trk" (flashing), "01 01" (flashing)-"56 56" (flashing) can be selected. This function is used when specifying any desired track and saving it.

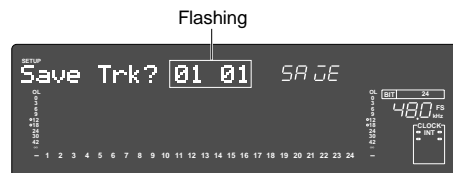

If you want to save tracks 05 through 24, select "05 05" and go to the next step. By rotating the jog dial while the display above is shown, you can select "01 01" through "56 56" besides "All Trk". The left and right numbers indicate the beginning and end tracks to be saved respectively.

- (6) **After selecting the track, press the [EXECUTE/YES] key.**

If "All Trk" or any desired track was selected, the display will change to the following.

**• When "All Trk" is selected:**

The display will change to making a new WAV file on the card and "SURE?" will flashes.



**• If "05-05" is selected:**

The Flashing "05 05" will change to flashing only of the right "05".

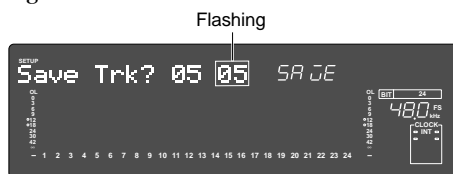

The last track can be selected. After setting to "05 24" by rotating the Jog dial and pressing the [EXECUTE/YES] key, the display will change the same as the previous "WAV [#0001] New PGM". Numbers that can be selected for the right two digits must be greater than the left two digits (In this example, either of "05 24"). This means that if the track was specified as "05 05", track 5 only will be saved.

- (7) **Press the [EXECUTE/YES] key.**

The display will change for entering the file name for the WAV file.



If the **Jog** dial is rotated at the flashing point, any desired number/symbol/alphabet can be input. The flashing point can be moved with the **Shuttle** dial. Characters which can be input are limited to the following:

**Alphabet capitals (A-Z)**  
**Numbers (0-9)**  
**Symbols (!, #, \$, %, &, ', (, ), @, ^, \_, -)**

Although up to 6 letters can be input for the file name, some of the letters/symbols/alphabets input here will be converted as follows.

**Alphabet capitals (A-Z) -> No conversion**  
**Alphabet small letters -> (a-z) Converted to capitals**  
**Numerals (0-9) -> No conversion**  
**Symbols -> No conversion**  
**Other symbols -> Under bar is converted to “\_”**

- (8) **After inputting a file name, press the [EXECUTE/YES] key.**

Save will be executed and the following displayed. During save, the capacity display will continue to count down.

At completion of save, the display returns to the original time base and **"COMPLETED!"** will light.

**<Note>:** *If you attempt to save a WAV file with the same name as an existing WAV file on the backup card, "Already Exist" (The same file already exists) will be displayed and save cannot be executed. For details, refer to the later "Using a backup card in which a program is already saved."*

- (9) **Press the [EXIT/NO] key or [STOP] button.**  
**"COMPLETED!"** is extinguished.

- **When using a backup card in which a program is already saved.**

If a program is already saved in the backup card, depending on the remaining capacity, the following selectable item may be added to the Step 6 Save Method. These can be selected by rotating the **Jog** dial.

**"Title" & "New PGM" display**

There is enough remaining capacity to make a new WAV file in addition to a WAV file on the card. Press the **[EXECUTE/YES]** key and proceed to Step 7. When saved to the card, this WAV file will be additionally recorded.

**Alternate display of "Title" & "New PGM" and "-###MB"**

Card capacity is short by the amount of "###" to be able to add a new WAV file. Press the **[EXECUTE/YES]** key and after display of **"Disk Full"**, **"Delete All WAV?"** is displayed, then, press the **[EXECUTE/YES]** key again, and it will go to Step 7 for deleting all WAV files on the backup card. After save, only saved WAV files will be recorded.

**"Title" & "-###MB" display:**

In this instance, the selected WAV file on the backup card is deleted and there is now enough capacity to make a WAV file. Press the **[EXECUTE/YES]** key and **"DEL"** (delete of WAV file) will be displayed, and when **[EXECUTE/YES]** key is pressed again, it will go to Step 7 for deleting the selected WAV file on the backup card. After save, the selected WAV file will be replaced as the new file and recorded on the card.

**"Title" & "-###MB" display:**

The card is short of capacity by the amount of "###" to be able to make a WAV file although the selected WAV file on the backup card is deleted. If the **[EXECUTE/YES]** key is pressed, after display of **"Disk Full"**, **"Delete All WAV?"** is displayed, and when the **[EXECUTE/YES]** key is pressed again, it will go to Step 7 for deleting all WAV files on the backup card. After save, only saved WAV files will be recorded.

**< Notes >**

- *If you attempt to save a WAV file with the same file name as one already existing on the backup card, "Already Exist" (Same file name already exists) is displayed and save will not be executed. In this case, change the WAV file name by the previous Step 7.*
- *In a card which had been repeatedly saved by overwriting, access speed could be lowered due to file fragmentation. We recommend that you use a card immediately after formatting for backup purposes.*
- *When files and folders other than file names "\*\*\*\*\*#.WAV" which can be acknowledged by this recorder are made on the backup card by using a computer, in some cases save cannot be completed as it cannot calculate the accurate remaining capacity of the backup card. Great care should be taken when changing file names and making folders by a computer.*

### Load function in FAT 16

The following procedure shows how to save a program to a FAT16 DOS formatted CompactFlash™ card as a WAV file. It is assumed that a FAT16 formatted unused CompactFlash™ card is set to the CF drive.

(1) Enter the **SETUP** mode by pressing the **[SETUP]** key.

(2) Select “Load PGM?” (“?” flashes) with the Jog dial and press the **[EXECUTE/YES]** key.  
The currently set content will be displayed (flashing).

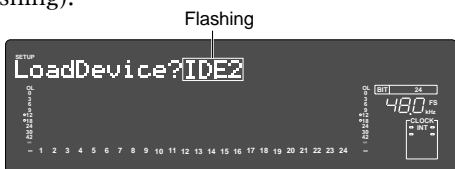

(3) Press the **[EXECUTE/YES]** key while “IDE2” is flashing.

The WAV file name and its capacity is displayed and “[ ]” will flash at the same time.



(4) Select the WAV file to be loaded with the Jog dial.  
If a multiple number of WAV files with different file names (Beginning 6 letters) have been saved, the WAV file names (beginning 6 letters) and capacity will be sequentially displayed.

**<Note>**: File names other than “\*\*\*\*\*#.WAV” cannot be acknowledged nor loaded by this recorder. WAV files with the beginning 6 letters of the file name will be individually acknowledged and can be selected.

(5) Select WAV file, then press the **[EXECUTE/YES]** key.  
The display will change to selecting the track to be loaded. “All Trk” will flash.  
If the Jog dial is rotated at this stage, “01-56” (mono tracks) can also be selected in addition to “All Trk”.

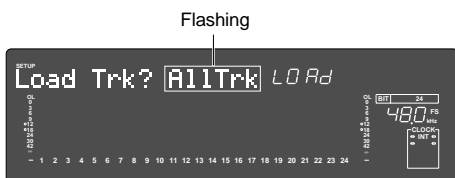

Select the mono track (01-56) then press the **[EXECUTE/YES]** key. A menu appears to select the load destination track.

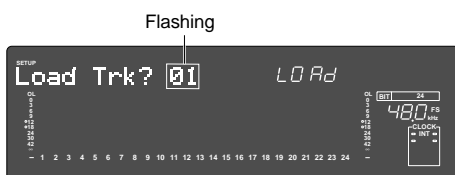

Turn the **Jog** dial in this state to select the load destination track (01-56 are selectable with the above example).

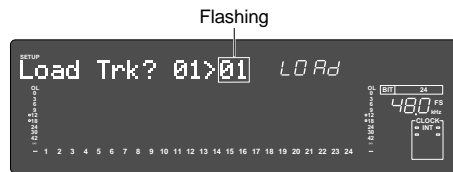

As an example, if the track is setup as shown below, data in track 1 will be loaded in track 8.

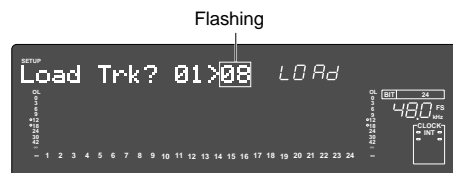

(6) Select the track, then press the **[EXECUTE/YES]** key.  
It will change to the display for compiling a new program (“New PGM”) in the objective track for loading.

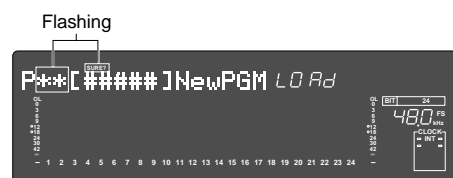

When the **Jog** dial is rotated while in this state, the program in the objective track for loading can be selected, and its recording capacity will also be shown. When loading by selecting an existing program, loading can be done in parallel with erasing (super scripting) this existing program.

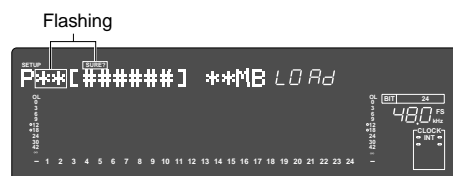

(7) After selecting the program to load, press the **[EXECUTE/YES]** key.

The following will be displayed during load. As load progresses, the capacity indication will count down. Upon completion of the load, the display will return to the original time base and “COMPLETED!” is displayed.



**<Note>**: The title of the loaded program will be replaced by the WAV file name (beginning 6 letters) which is loaded.

**<Note>:** If there is insufficient capacity in the current drive to load a WAV file, the capacity will be indicated in minus as "-###". In such a case, select a program of a the right size or delete an unnecessary program by using the SETUP mode "Delete PGM##."

### Save function in FAT 32

You can save a program to a FAT32 DOS formatted CompactFlash™ card (or the optional E-IDE hard disk drive) as a WAV file (or a DAT file). Before performing save operation, read the following.

#### About files to be saved

In each of the WAV and BACKUP folders on a backup disk formatted in FAT 32, multiple storage folders for storing saved files are automatically created. (The number of storage folders depends on the hard disk capacity. In the case of a 40-GB hard disk, for example, five storage folders in the WAV folder and 20 storage folders in the BACKUP folder are created.)

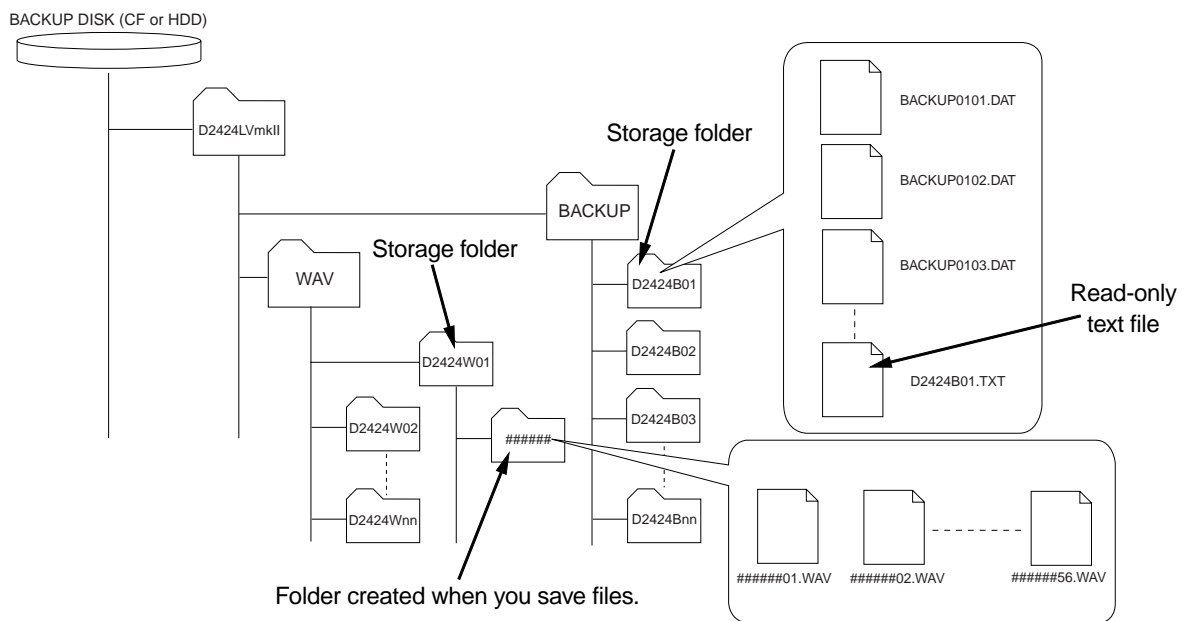

In each storage folder in the BACKUP folder, you can save data files with ".DAT" extension (we call them "DAT files" in this document) as backup of FDMS-3 files. During save operation, the unit creates DAT files with the name of "four characters + folder number (in two digits) + DISK number (01 through 99) + .DAT", as well as a read-only text file which contains program information (see above).

In each storage folder in the WAV folder, a subfolder with a six-character name is created during save operation. In the subfolder, mono WAV files (for tracks 1 through 56 or 1 through 24) with the name of "six characters + 2-digit track number + .wav" are created. Note that the size of each WAV file is limited to approximately 4 GB.

**<Note>:** In the BACKUP and WAV folders, storage folders are created when the drive is formatted. Each BACKUP storage folder has the name of "D2424B\*\*" (where \*\* is a two-digit number), while each WAV storage folder has the name of "D2424W\*\*" (where \*\* is a two-digit number).

If you newly create a storage folder using a personal computer, give an appropriate folder name which has the sequential number.

**Storage folders in the BACKUP folder**

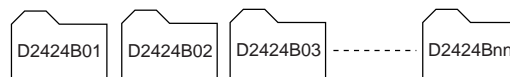

**Storage folders in the WAV folder**

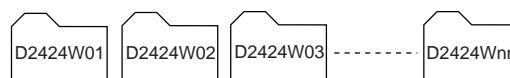

**<Note>:** The BACKUP folder is used for saving DAT files for backup of FDMS-3 files. The saved DAT files cannot be read or edited by a personal computer. However, in each storage folder, a file (text file) of list of programs recorded on saved DAT files is created so you can check the contents of the saved programs by opening the text file.

The following procedure shows how to save a program to a FAT32 DOS formatted CompactFlash™ card (of more than 530 MB).

It is assumed that a FAT32 formatted CompactFlash™ card is set to the CF drive. Note that you can save a program to the E-IDE hard disk for backup instead of the CF drive in the similar manner.

- (1) While the unit is stopped, press the [SETUP] key to enter the SETUP mode.
- (2) Use the jog dial to select "Save PGM" menu and press the [EXECUTE/YES] key. "IDE2" flashes.

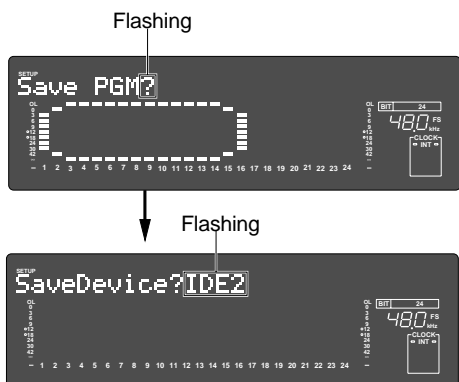

- (3) While "IDE2" is flashing, press the [EXECUTE/YES] key. After the display briefly shows the backup drive name, you can now select the destination storage folder.

"B01" initially flashes. You can use the jog dial to select a storage folder from "B01" to "Bnn" or from "W01" to "Wnn".

When you save DAT files, select any storage folder from "B01" to "Bnn". When you save WAV files, select a storage folder from "W01" to "Wnn".

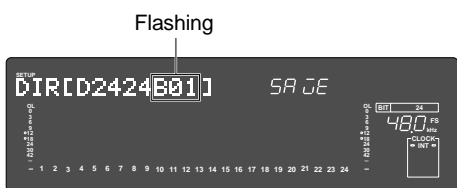

See below for the procedure for saving WAV files. See page 101 for the procedure for saving DAT files.

## Saving a WAV file

**<Note>**: A WAV file saved to a DOS-formatted backup disk can be used on a personal computer. Note that, however, the D2424LVmkII does not support a long file name. Therefore, if you give a long file name using a computer, the D2424LVmkII may not read it.

- (4) Use the jog dial to select a desired WAV storage folder ("W01" through "Wnn") and press the [EXECUTE/YES] key. You can now select ON or OFF of clipboard export. Initially OFF flashes.

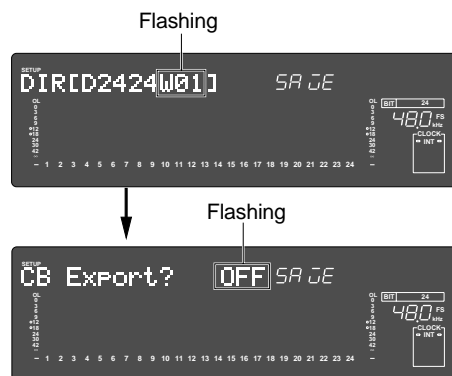

Select "OFF" when you save all data from ABS 0 to REC END. Select "ON" when you save data in the desired selected area. (For details about CB Export function, see page 98 of the reference manual.)

- (5) While "OFF" flashes, press the [EXECUTE/YES] key. You can now select a program to be saved.

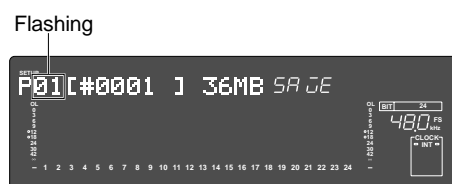

- (6) Use the jog dial to select a desired program and press the [EXECUTE/YES] key. You can now select the desired track(s) to be saved. Initially "All Trk" flashes.

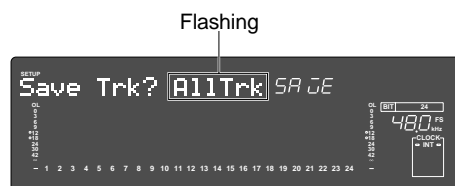

In this condition, you can select the desired track(s) by rotating the jog dial (see the operation example below).

**<Operation example>**  
Saving tracks 05 through 24.

- Use the jog dial to select "05 05" and press the [EXECUTE/YES] key.  
The right "05" of "05 05" starts flashing.

- Use the jog dial to select "24".

- After selecting the desired track(s), press the [EXECUTE/YES] key.  
You can now create the new WAV file(s) in the WAV folder. "SURE?" and "[ ]" flash.



- Press the [EXECUTE/YES] key.  
You can now edit the file name of the newly created WAV file(s). You may also use the tentative name without editing.  
For details about how to edit a name, see page 97 of the reference manual.



**<Note>:** In the FAT 32 system, if a WAV file with the same file name already exists in the destination folder, you cannot overwrite it with the new file. In such a case, you must change the file name.

- After editing the file name (or without changing the tentative file name), press the [EXECUTE/YES] key.  
The file(s) is/are saved to the WAV storage folder. After the unit completes file saving, the display returns to show the previous screen which was shown before entering the SETUP mode.

## Saving a DAT file

**<Note on deleting a DAT file>:** The unit can save a DAT file but cannot delete a DAT file. You can delete a DAT file from a personal computer. Do not delete the BACKUP storage folder (only delete a DAT file). Also note that, by deleting a file, the continuity of the FAT system is lost, which may result in slower data reading/writing speed. If you want to delete an individual program in a DAT file, load the DAT file to the unit and use the program delete function of the unit.

- Use the jog dial to select a desired DAT storage folder ("B01" through "Bnn") and press the [EXECUTE/YES] key.  
You can now select the program(s) to be saved.

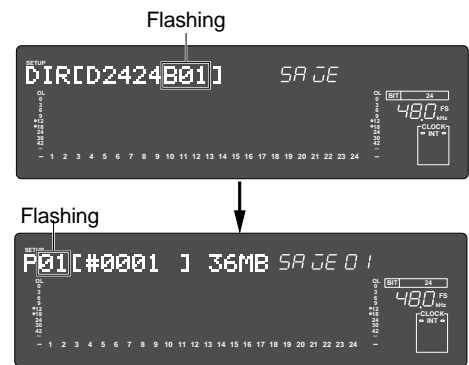

By rotating the jog dial, you can select the desired program(s) as well as all programs ("Save All").

**<Caution>:** After executing the operation above, do not turn off the power until the unit completes save operation. By doing so, the FAT 32 format system may be damaged. If you need to turn off the power during save operation, exit the SETUP mode first by pressing either [STOP] or [EXIT/NO] key and then turn it off.

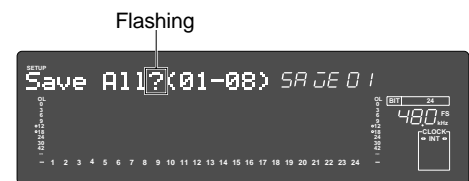

**<The screen where "Save All" is shown>**

To save the desired program(s), select the program(s) in the following manner before going to step (5).

To select "Save All" and save all DAT files, go to step (5) after executing the following operation.

By selecting "Save All" and press the [EXECUTE/YES] key, you can specify the desired program to be saved.

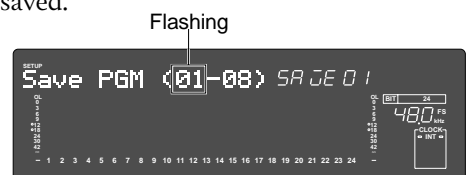

By rotating the jog dial in the condition above, you can change the first program you save.

You can use the shuttle dial to move the flashing point to "08", where you can change the last program you save.

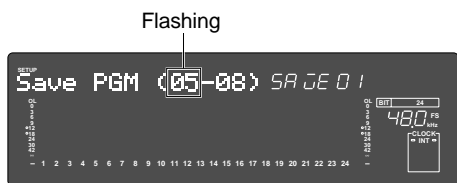

<When you change first program you save>

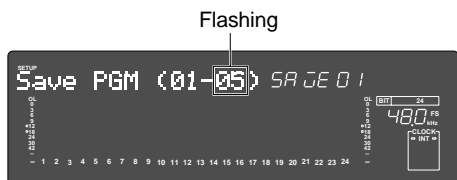

<When you change the last program you save>

**<Note>**: When you attempt to save a program individually, if the corresponding file already exists in the destination folder, the program is newly saved (not overwritten) and the display shows "[NewPGM]".



**<Note>**: When you select "Save All", if "(01-xx)" (for example, "(01-08)") and "\*\*MB" alternatively flash, program 01 (the first program to be saved) cannot be saved because its size exceeds the remaining space of the destination disk.

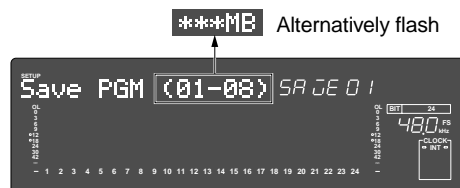

When you select "Save All", if the right number in the parentheses (the last program number you save) is less than the maximum program number, you cannot save all programs.

If there are eight programs but you can save only from program 01 to program 04 because of the limitation of the space of the destination disk, the display shows (01-04) as below.)

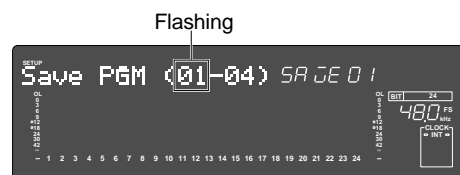

**(5) After selecting the program(s) to be saved, press the [EXECUTE/YES] key.**

The program(s) is/are saved to the BACKUP storage folder.

After the unit completes saving, the display returns to show the previous screen which was shown before entering the SETUP mode.

**<Note>**: If any DAT file already exists in the destination folder, "24bit" or "16bit" is shown on the display. In this condition, only programs with the same bit as the shown bit can be saved.

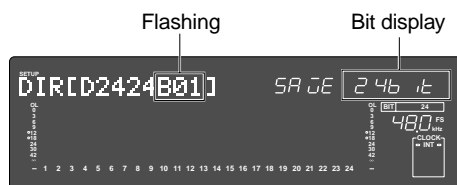

<When any DAT file already exists in the storage folder>

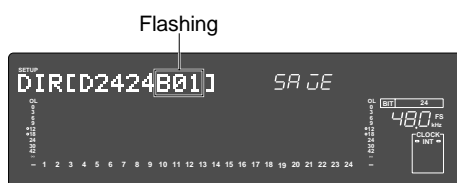

<When no DAT file exists in the storage folder>



**Load function in FAT 16**

The following procedure shows how to load a WAV file on a FAT32 formatted CompactFlash™ card to the current drive of the unit.  
It is assumed that the CompactFlash™ card is normally set to the CF drive and a program is loaded to the current drive.

- (1) While the unit is stopped, press the [SETUP] key to enter the SETUP mode.
- (2) Use the jog dial to select "Load PGM" menu and press the [EXECUTE/YES] key. "IDE2" flashes.

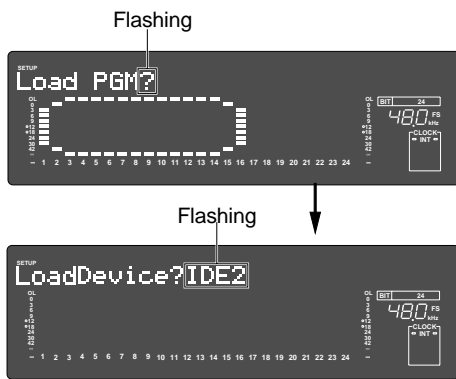

- (3) While "IDE2" is flashing, press the [EXECUTE/YES] key. After the display briefly shows the backup drive name, you can now select the storage folder from which you load a file.

"B01" initially flashes. You can use the jog dial to select the storage folder from "B01" through "Bnn" or "W01" through "Wnn".

When you load a DAT file, select "B01" through "Bnn" in the BACKUP folder. When you load a WAV file, select from "W01" through "Wnn" in the WAV folder.

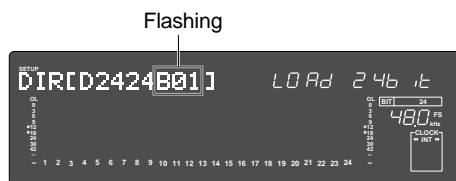

See below for the procedure of loading a WAV file. See page 106 for the procedure for loading a DAT file.

**Loading a WAV file**

- (4) Use the jog dial to select a WAV storage folder and press the [EXECUTE/YES] key. You can now select a desired WAV file in the selected storage folder.

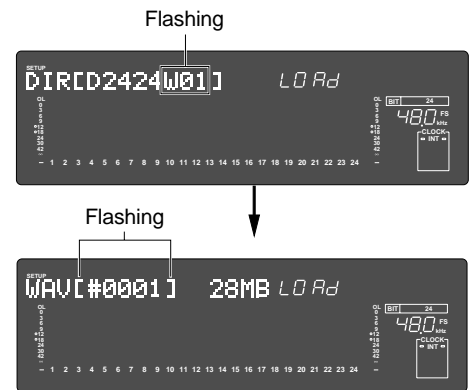

- (5) Use the jog dial to select a desired WAV file to be loaded and press the [EXECUTE/YES] key. You can now select the desired track(s) to be loaded. Initially "All Trk" flashes. If you select "All Trk", you can load all tracks in the selected WAV file.

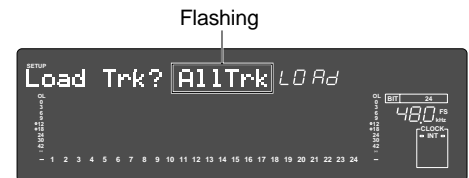

In this condition, you can select the desired track(s) by rotating the jog dial. The number of available tracks depends on the saved WAV files.

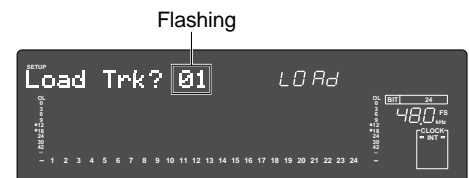

See <Setting example> on the next page for details about how to specify the desired track(s) to be loaded.

**<Setting example>**

The following shows the procedure for loading track 04 in the WAV file to track 12 of the current program.

1. Use the jog dial to select "04" and press the [EXECUTE/YES] key.  
Track 04 is set to be loaded, and you can now select the destination track.

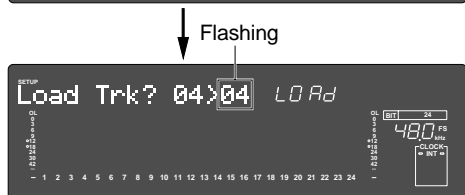
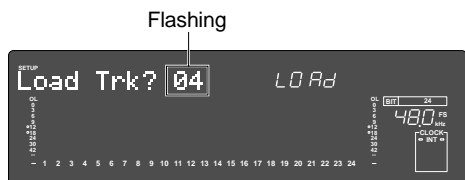

2. Use the jog dial to select "12" and go to procedure (6) below.

- (6) Select "All Trk" or any desired track and press the [EXECUTE/YES] key.  
You can now select the program to which the selected track(s) is/are loaded.

Initially a new program (New PGM) is selected. In the screen example below, seven programs exist in the destination hard disk and new program "P08" can be created.



In this condition, by rotating the jog dial, you can also select an existing program for the load destination. The available recording size of the selected program is shown.



If you select an existing program, existing track data is overwritten when a track is loaded.

- (7) Select the load destination program and press the [EXECUTE/YES] key.  
The track is loaded to the selected program (new program or existing program). After the unit completes loading, the display returns to show the previous screen which was shown before entering the SETUP mode.

**Loading a DAT file**

**<Note>**: When you restore a DAT file stored to a personal computer to the unit, copy the whole BACKUP folder which stores a DAT file to the backup disk. You can copy only a DAT file, however, make sure that the DAT file is copied to the copy source BACKUP storage folder.  
If you copy a DAT file to an unmatched folder, the unit cannot recognize the DAT file when loading.

- (4) Use the jog dial to select a DAT storage folder and press the [EXECUTE/YES] key.  
You can now select a desired DAT file in the selected storage folder.

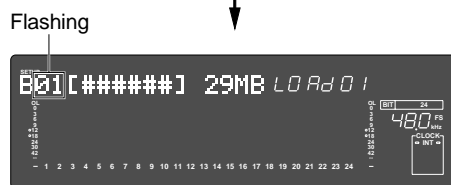
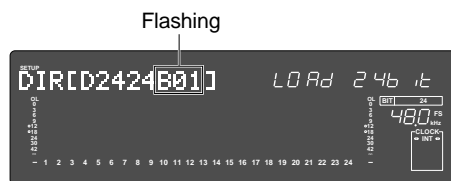

By rotating the jog dial in this condition, you can select a desired DAT file or all DAT files ("Load All").

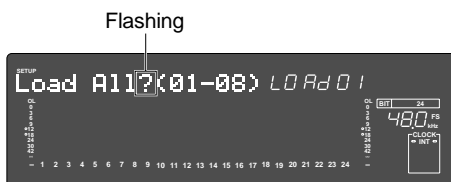

**<The screen where "Load All" is shown>**

To load a DAT file, select the desired DAT file and go to step (5).  
To select "Load All" and load all DAT files, execute the following operation and go to step (5).

By selecting "Load All" and press the [EXECUTE/YES] key, you can specify the desired DAT file(s) to be loaded. See the following procedure example for details about how to specify the DAT file(s) to be loaded.

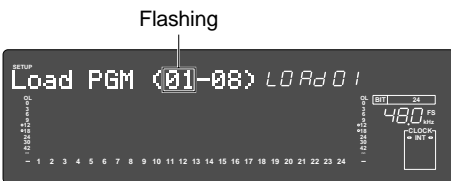

By rotating the jog dial in this condition, you can change the first DAT file you load. You can use the shuttle dial to move the flashing point to the right number ( "08" in the example below), where you can change the last DAT file you load.

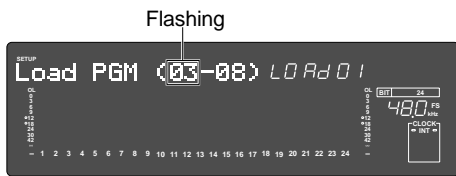

<When you change the first DAT file you load>

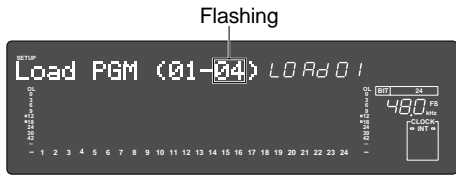

<When you change the last DAT file you load>

**<Note>**: When you select "Load All", if "(xx-yy)" ("01-08" in the example below) and "\*\*\*MB" alternatively flash, file xx ("01" in the example below, the first DAT file to be loaded) cannot be loaded because its size exceeds the remaining space of the current disk.

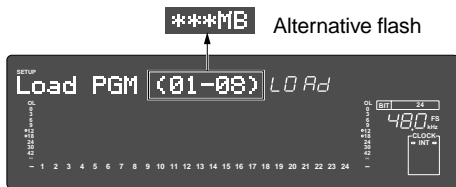

When you select "Load All", if the right number in the parentheses is less than the maximum file number, you cannot load all DAT files because of the remaining space of the current disk.

For example, if there are eight DAT files but you can load only from file 01 to file 04, the display shows (01-04) as below.)

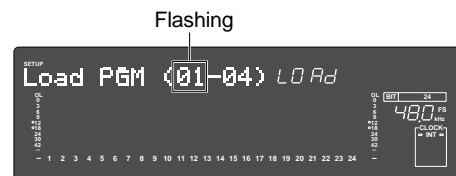

- (5) **After selecting the program(s) to be loaded, press the [EXECUTE/YES] key.**

When you select "Load All", loading starts immediately. After the unit completes loading, the display returns to show the previous screen which was shown before entering the SETUP mode.

When you select an individual program, the display allows you to select the program destination.



<The display after you select an Individual program>

On the display above, you can create a new program on the destination hard disk or select an existing program to which the program is loaded.

To create a new program to which the program is loaded, press the [EXECUTE/YES] key when the display shows as above.

To load the program to an existing program and overwrite it, use the jog dial to select the destination program and press the [EXECUTE/YES] key.

- (6) **Select the new (or an individual) program and press the [EXECUTE/YES] key.**

Loading starts immediately.

After the unit completes loading, the display returns to show the previous screen which was shown before entering the SETUP mode.

# Changing the Initial Settings (SETUP mode)

The SETUP mode offers the Changing the initial settings menus to configure the operating environment of the recorder, a “Check” menu that enables you to check the number of events of each track and the “Execution” menus to execute certain operations such as save/load and disk formatting.

In this chapter we will explain procedures only on <Table-1> “Changing the initial settings” menu (except setting the internal clock) and <Table-2> “Check” menu. To learn how to set the internal clock, refer to the “Quick operation guide,” and on the “Execution” menu, the “Reference page” written in <Table-3>.

**<Table-1> “Changing the initial settings” menu**

Parameters	Display	Default setting	Refer page	Community
Setting a time signature	Signature Set ?	001bar 4/4	110	○
Setting a Tempo	Tempo Map Set ?	001bar 1♩ 120	112	○
Setting the metronome function	Click ♪ ?	Off	113	○
Setting a preroll time	Preroll Time ?	00s	113	○
Setting MIDI sync output signal	Midi Sync Out ?	MTC	114	○
Setting an MTC frame rate	Frame Rate ?	25 frame	114	○
Setting an MTC offset value	MTC OFFSET	00h 59m 57s 00f 00sf	115	○
Setting Offset mode	Offset Mode ?	ABS	115	○
Setting a reference time code	Ref. TC ? Void!	Available with option Model 8346 (Refer to APPENDIX)		
Setting the slave type	Slave Type ?	Vari	116	○
Setting the record protect function	Rec Protect ?	Off	117	○
Setting digital input tracks	D. in ?	Analog	117	●
Setting digital output tracks	D. out ?	adat	118	●
Setting BAR/BEAT resolution mode	♪ Resolution ?	Off	119	●
Setting the MIDI device ID number	Device ID ?	00	120	●
Setting the operating clock	Clock Sel ?	Int.	120	●
Setting the SYNC preset	Sync Preset ?	Available with option Model 8346 (Refer to the APPENDIX)		
Setting the Virtual LTC display	Virtual LTC ?	Available with option Model 8346 (Refer to the APPENDIX)		
Setting the chase offset display	Offset Disp ?	Available with option Model 8346 (Refer to the APPENDIX)		
Setting the internal clock	Date & Time Set ?	Please refer to the “Quick Operation Guide.”		
Setting the Auto EE mode	Auto EE Mode ?	Off	122	●
Setting the Foot switch function	Foot SW ?	Punch IO	122	●
Setting the stop function at the mark point	Mark Stop MD ?	Off	123	●
Setting input/output Balance/Unbalance	BAL/UNBAL ?	UNBAL	123	●
Setting the display contrast level	Contrast ?	Level 6	126	●
Setting the 0 file recording	Zero File?	Enable	126	●
Setting the sampling freq. of the PGM	Sample Rate?	-	42	-
Setting the chain play mode	Chain Play?	Off	61	○
Drive setting	Drive Sel. ?	IDE1	125	-

○ : Modes applicable program by program. They can be saved/loaded.

● : Modes applicable to all programs. They cannot be saved/loaded.

**<Table-2> “Check” menu**

Check item	Display	Refer page	Community
Check of the Event number on the track	NOs Of Event ?	121	-
Check of the current drive status	Drive Info ?	124	-

**<Table-3> “Execution” menu**

Execution item	Display	Refer page	Community
Editing a program title	Title Edit PGM** ?	41	-
Deleting a program	Delete PGM** ?	40	-
Loading song data	Load PGM ?	90	-
Saving song data	Save PGM ?	90	-
Optimizing a Disk	Disk Optimize ?	37	-
Formatting a Disk	Disk Format ?	32	-
Editing a track name	Track Name Edit?	79	-
Converting the additional track	Add. Trk Convert?	127	-
Setup of the Chain Play List	Chain Play List?	63	-

## Selecting SETUP menu

Follow the steps below to select the desired SETUP menu in SETUP mode.

**(1) While the recorder is stopped, press the [SETUP] key on the control panel.**

Pressing the [SETUP] key causes the recorder to enter SETUP mode. The recorder displays the first hierarchy level of the SETUP menu you selected before you turned off the power. At this time, the menu graphic appear as shown below. The flashing menu indicator is the currently-selected menu. Turning the **Jog** dial will select a different menu and the corresponding menu indicator will flash.

**<Note>:** With the factory initial settings, or when you turn on the power again after you format a current drive disk, **“Signature Set? (Setting a signature)”** appears. Otherwise, the first hierarchy level of the previously-selected SETUP menu appears.

To exit SETUP mode, press the [STOP] button or the [EXIT/NO] key. Each time you press one of these keys, the recorder returns to the previous hierarchy level of the menu, and finally exits SETUP mode.

The title of the SETUP menu appears. You can select a different menu via the Jog dial.

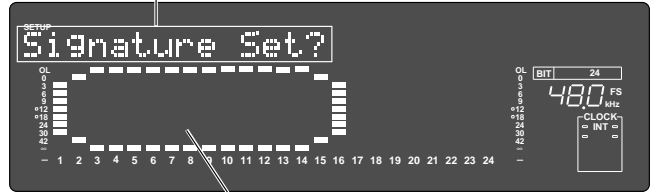

This indicates the position of the SETUP menu. Selecting a menu via the Jog dial will move the flashing cursor.

**(2) Select the desired menu using the Jog dial, then press the [EXECUTE/YES] key.**

The recorder displays the second hierarchy level of the selected SETUP menu, where you can set parameters.

**<Note>:** Although titles of the **“Ref. TC ?”** menu, **“Offset Disp ?”** menu, **“Virtual LTC ?”** menu and **“Sync Preset ?”** menu will also be displayed, these menus will only function when an optional Model 8346 TC/SYNC card is installed. Refer to the **“APPENDIX”** for details. **“Reserve”** is the extra position for future extension of the SETUP mode menu.

## Time Signature Setting

Using the “**Setting a time signature**” menu, you can set a time signature of a given measure on the internal programmable Tempo Map. And also in this setting, the BAR (-002bar, 1♩, 00clk) displayed at the head of the disk in the time base BAR/BEAT/CLK can be set within the range of -009bar ~ -002bar. For example, you can specify “4/4 for the first and second measures, and 2/2 from the third measure.” Setting a time signature and tempo will create a Tempo Map, which allows the recorder to manage a song using the BAR/BEAT/CLK Time Base. You can also use the Metronome function. A time signature and tempo setting are required when MIDI clock & song position pointer are output to an external sequencer.

- **Initial Setting** : 001bar 4/4 beat
- **Available bars** : 001 ~ 999
- **Available time signature:** 1/4, 2/4, 3/4, 4/4, 5/4, 1/8, 3/8, 5/8, 6/8, 7/8, 8/8, - /- - (Delete)
- **Maximum setting points:** 64
- \* The setting is applicable song by song.
- \* The setting can be saved or loaded as a part of the song data
- \* The setting is memorized even when the power is off.
- \* Make sure you choose the right program before setting this mode.

## Storing a time signature

- (1) **Select a Program for which to set a time signature.**  
Refer to “Using the Program Change function” on page “37” for information on selecting a Program.
- (2) **Press the [SETUP] key, use the Jog dial to select the “Signature.Set ?” menu, then press the [EXECUTE/YES] key.**  
The indication changes to the current time signature appears. The initial setting is “001bar 4/4♩” (4/4 for the first measure).

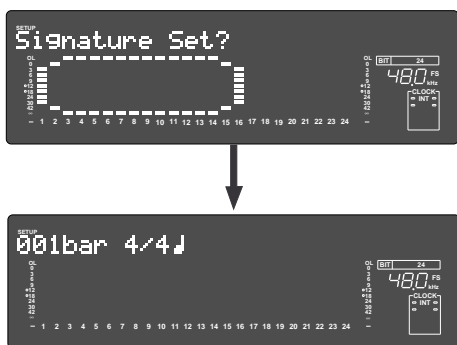

At this time, rotating the **Jog** dial clockwise enables you to check the current time signatures in sequence.

With the initial setting, time signatures after the first measure are all “- -bar -/♩”. This means that a time signature of 4/4 applies to all measures.

- (3) **Press the [EXECUTE/YES] key.**  
The indication changes to “001 (measure)” of “001bar 4/4♩” flashes. You can enter any time signature here.



- **Rotate the Jog dial to enter the desired measure number.**

If you wish to keep the initial setting for the first measure, enter 002. If you try to enter any number other than 001, the time signature indicator shows “-/♩”. This means that no time signature is set for any measures other than the first measure. To change the time signature for the first measure, follow the steps below, without entering any other measure number.

- **Turn the Shuttle dial to display flashing “-/” of “-/♩” and enter the time signature using the Jog dial.**

The following measure numbers and time signatures can be entered via the **Jog** dial.

<b>Measures</b>	001-999, selection of [All Clear?] indication. [All Clear?] means that data in its entirety will be cleared. This is used to initialize the parameter. (Refer to “Clearing stored time signature/tempo data.”)
<b>Time signatures</b>	1/4, 2/4, 3/4, 4/4, 5/4, 1/8, 3/8, 5/8, 6/8, 7/8, 8/8, - /- [- /-] means no time signature assigned, and is used to delete time signature data. (Refer to “Modifying (or deleting) stored time signatures” for more information.)

### <Note>

You cannot assign “- -” to measure 001.

- (4) **Press the [EXECUTE/YES] key whenever you enter a pair of measure/time signature values.**  
Repeat this step to specify the necessary time signature for the measures.

To cancel the setting operation, or to exit SETUP mode after storing data, press the [STOP] button or the [EXIT/NO] key. Each time you press one of these keys, the recorder returns to the previous hierarchy level of the menu, and finally exits SETUP mode.

## Modifying (or deleting) stored time signatures

- (1) **Repeat steps 1-3 described in the “Storing a time signature” section.**
- (2) **Turn the Shuttle dial so that the flashing cursor is on the time signature value.**
- (3) **Use the Jog dial to enter a new value.**  
Entering “-/” deletes the existing data. Note that you cannot enter “-/” for measure 001.
- (4) **Press the [EXECUTE/YES] key.**
- (5) **Press the [EXIT/NO] key (or [STOP] button).**

**<Caution>**: If modifying or deleting the stored time signature causes the bar/beat setting for the tempo specified in the “Setting a tempo” menu to disappear, the tempo setting will also be automatically erased.

To cancel the setting operation, or to exit SETUP mode after storing data, press the [STOP] button or the [EXIT/NO] key. Each time you press one of these keys, the recorder returns to the previous hierarchy level of the menu, and finally exits SETUP mode.



- (4) Use the Jog dial to enter a new value.
- (5) Press the [EXECUTE/YES] key.
- (6) Press the [EXIT/NO] key (or [STOP] button).

To cancel the setting operation, or to exit SETUP mode after storing data, press the [STOP] button or the [EXIT/NO] key. Each time you press one of these keys, the recorder returns to the previous hierarchy level of the menu, and finally exits SETUP mode.

## Clearing all time signature and tempo settings

**<Caution>**: Using this function will erase not only the time signature setting but also the tempo data specified in the “Setting a tempo” menu described in the next section.

- (1) Repeat steps 1-3 described in the “Storing a time signature” section.
- (2) While the measure number is flashing, turn the Jog dial counter-clockwise to select “All Clear?.” When “All Clear ?” appears, “SURE ?” flashes, and you can clear the time signature and tempo data in the next step.



- (3) Press the [EXECUTE/YES] key. The stored time signature and tempo data in its entirety are cleared, and the initial settings are restored.
- (4) Press the [EXIT/NO] key (or [STOP] button).

To cancel the All Clear operation, press the [STOP] button or the [EXIT/NO] key now. Each time you press one of these keys, the recorder returns to the previous hierarchy level of the menu, and finally exits SETUP mode.

## Changing the bar at ABS “0” of the time base

Bar in -002bar/1beat/00clk, which indicates the head figure of the disk in the time base BAR/BEAT/CLK, can be changed. Although the initial figure is -002bar, this can be set within the range of -009bar ~ -002bar.

- (1) Repeat steps 1-2 described in the “Storing a time signature” section.
- (2) Turn the Jog dial counter-clockwise to select “-002 bar Offset.”
- (3) Press the [EXECUTE/YES] key. “2” in “-002bar” will flash and the bar figure can be changed with the Jog dial (Numbers that can be input are 2~9.)

## Setting a tempo

The “**Setting a tempo**” menu enables you to specify a tempo at a given point in a song that already has a time signature setting. For example, you can specify a tempo of 150 to the third beat of the 12th measure. Time signature and tempo settings make a Tempo Map, which is used by the recorder to manage the song using the BAR/BEAT/CLK Time Base, and enable the Metronome function. Tempo settings as well as time signature settings are required when you wish to output MIDI clock and Song Position Pointer to an external sequencer.

**<Note>**: The tempo set figure setup here is an approximate figure and not 100% accurate. Therefore, although the tempo may be matched to a personal computer, they will gradually drift apart. In order to prevent this drift, the personal computer side can be set to either MIDI Clock Sync or, the MIDI sync output signal temporarily set to “MIDI Clock,” the figure reset to the accurate tempo and then return again to MTC sync.

- Initial setting:  
bar 001, beat 1: 120 (001 bar 1 beat 120 tempo)
- Setting range of measures:  
Determined by the time signature setting.
- Setting range of beats:  
Determined by the time signature setting.
- Setting range of tempo:  
30-250/quarter note, — (delete)
- Max. setting points:  
64 points
- \* You can set the tempo for each Program individually.
- \* The settings can be saved and loaded as part of song data.
- \* The settings are maintained after you turn off the power to the recorder.

## Checking the stored tempo setting

- (1) **Select a Program to check the tempo setting for.**  
Press the [SETUP] key, use the Jog dial to select the “Tempo Map Set ?” menu, then press the [EXECUTE/YES] key. Indication on the display changes as shown below, and the current tempo appears. The initial setting is “001 bar 1 ♩ =120”. This means that a tempo for the first beat of the first measure is set to 120.

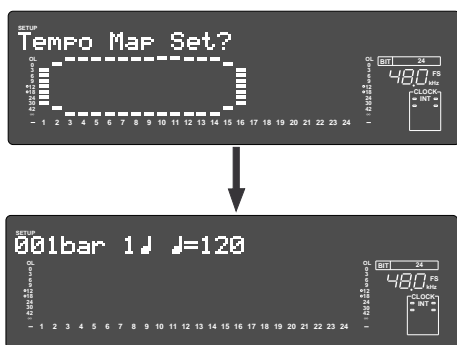

- (2) **Rotate the Jog dial clockwise.**  
You can view the current tempo values in sequence. Tempo value “--- bar ♩ = ---” means that no tempo values are specified after the current setting. With the initial setting, “001bar 1 ♩ =120” is followed by “--- bar ♩ = ---”.

## Storing a tempo value

- (3) **Press the [EXECUTE/YES] key.**  
The indication changes to “001 (measure)” of “001bar” flashes. (See the figure below.) This means that you can enter a value now.



- (4) **Turn the Shuttle dial to move the flashing cursor to the desired edit location, and use the Jog dial to enter the bar/beat/tempo information to be stored.**

The bar and beat settings for the time signatures determine the setting range of bar and beat settings for the tempo. You can specify a tempo between 30 and 250 per quarter note. The indication “♩ = ---” means “no tempo,” which is used to delete a tempo setting. When you turn the Jog dial, “♩ = ---” appears for the bars and beats for which no tempo has been set.

- (5) **Press the [EXECUTE/YES] key.**  
The display shows the stored bar/beat/tempo, then returns to the Tempo Edit indication (as shown in step 4).

- (6) **Repeat steps 3-5 to store necessary tempo data.**  
For example, if you specify tempo values in the song with “001bar 4/4 ♩” and “005bar 3/4 ♩” settings, the Tempo Map includes the settings shown in the table below.

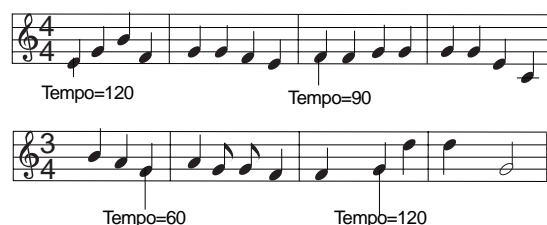

Tempo Map	
Time signature setting	Tempo setting
001 bar 4/4 ♩	001 bar 1 ♩ = 120 003 bar 1 ♩ = 90
005 bar 3/4 ♩	005 bar 3 ♩ = 60 007 bar 2 ♩ = 120

## Modifying (or deleting) stored tempo settings

- (1) **Repeat steps 1-3 described in the “Storing a tempo value” section.**
- (2) **Turn the Jog dial to select bar/beat to edit or delete.**
- (3) **Turn the Shuttle dial so that the flashing cursor is on the TEMPO number.**
- (4) **Use the Jog dial to enter a new value.**  
Entering “---” deletes the data at the selected bar/beat.



- (5) Press the [EXECUTE/YES] key.
- (6) Press the [STOP] button or the [EXIT/NO] key repeatedly to exit SETUP mode.

To cancel the setting operation, or to exit SETUP mode after storing data, press the [STOP] button or the [EXIT/NO] key. Each time you press one of these keys, the recorder returns to the previous hierarchy level of the menu, and finally exits SETUP mode.

- (3) Turn the Jog dial to select “On” or “Off”.  
Selecting “On” will enable the output of the metronome sound. Selecting “Off” (initial setting) will disable the metronome output.
- (4) Press the [EXECUTE/YES] key.  
The display shows the selection (On or Off), then returns to the indication in step 2.

To cancel the setting operation, or to exit SETUP mode after storing data, press the [STOP] button or the [EXIT/NO] key. Each time you press one of these keys, the recorder returns to the previous hierarchy level of the menu, and finally exits SETUP mode.

### Setting the Metronome function

“Setting the Metronome function” menu allows you to determine whether or not the recorder outputs a metronome sound from Real track (track 24) during playback or recording. Turning the Metronome function on enables you to record your performance while playing the instrument accompanying the metronome sound.

#### <Notes>

- The metronome sound is output from track 24 in the D2424LVmkII.
- When the metronome function is switched ON, the metronome sound cannot be recorded on the output track nor can the recorded sound be played back. However, in a D2424LVmkII formatted in 96kHz/24bit (8 track) or 88.2kHz/24bit (8 track), as the metronome sound will be output from track 24, real tracks 1-8 can all be used for record/playback.

- Initial setting: [Off]
- Option: [Off], or [On]
- \* You can turn the function on and off for each Program individually.
- \* The settings cannot be saved and loaded as part of the song data.
- \* The settings are maintained after you turn off the power to the recorder.

- (1) While the recorder is stopped, press the [SETUP] key to enter SETUP mode.
- (2) Turn the Jog dial to select “Click ?” (“?” flashes.), then press the [EXECUTE/YES] key.  
The current setting (“Off” or “On”) appears on the display.  
Pressing the [EXECUTE/YES] key lights up the flashing “?” character steadily; the current setting flashes. The initial setting is “Off” as shown below.

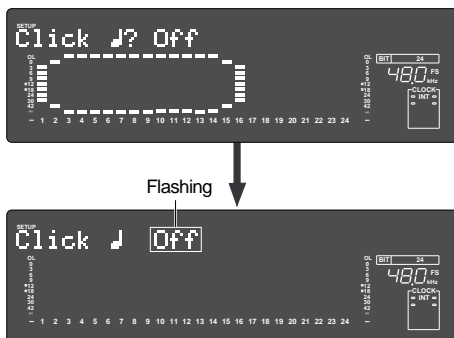

### Setting a preroll value

The recorder features the Preroll function that enables you to locate a position a few seconds prior to a specified locate point. The “Setting a preroll value” menu allows you to set the preroll time (in seconds). The Preroll function is convenient when you wish to monitor the audio data from a point slightly before the locate point.

- Initial setting: [00] second
- Setting range of preroll time: [00] - [10] seconds in one second steps
- \* You can set the value for each Program individually.
- \* The settings can be saved and loaded as part of the song data.
- \* The settings are maintained after you turn off the power to the recorder.

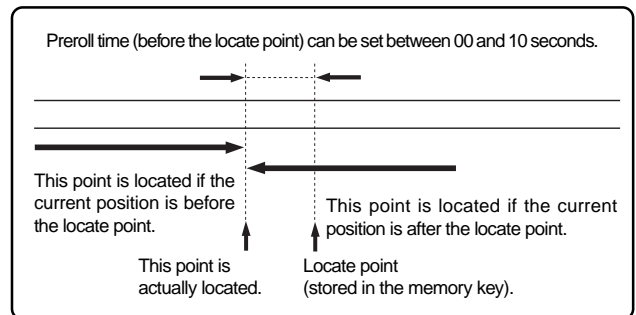

- (1) While the recorder is stopped, press the [SETUP] key to enter SETUP mode.
- (2) Turn the Jog dial to select “Preroll Time ?” (“?” flashes.), then press the [EXECUTE/YES] key.  
The current preroll time setting appears on the display. Pressing the [EXECUTE/YES] key lights up the flashing “?” character steadily; the current setting flashes. The initial setting is “00” as shown below.

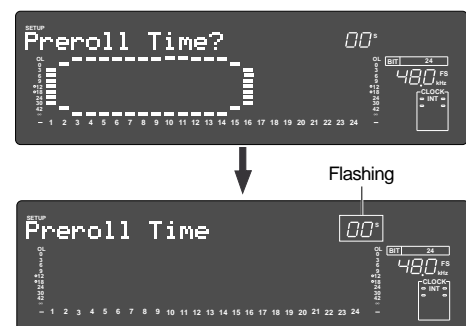

- (3) **Turn the Jog dial to enter a desired preroll time value.**  
You can set a value in one-second increments. Rotating the **Jog** dial clockwise increases the value, and rotating it counter-clockwise decreases the value.
- (4) **Press the [EXECUTE/YES] key.**  
The display shows the value, then returns to the indication that appeared in step 2.

To cancel the setting operation, or to exit SETUP mode after storing data, press the [STOP] button or the [EXIT/NO] key. Each time you press one of these keys, the recorder returns to the previous hierarchy level of the menu, and finally exits SETUP mode.

### Setting MIDI sync output signal

The “**Setting MIDI sync output signal**” menu enables you to select the type of MIDI sync signals output from the MIDI OUT connector on the rear panel of the recorder to an external MIDI device. The options are MIDI clock & Song Position Pointer, or MTC (MIDI time code). Select an appropriate option depending on the type of signal supported by the connected MIDI device. If you select MIDI clock & Song Position Pointer, first you need to set the time signatures and tempo as described previously. If you select MTC, you first need to set the MTC frame rate, the MTC offset time, and the MTC offset mode as described later.

- Initial setting: **[MTC]**
- Option: **[CLK]** (clock & Song Position Pointer), **[MTC]** (MIDI time code), **[Off]** (no output)
- \* You can set the parameters for each Program individually.
- \* The settings can be saved and loaded as part of the song data.
- \* The settings are maintained after you turn off the power to the recorder.

- (1) **While the recorder is stopped, press the [SETUP] key to enter SETUP mode.**
- (2) **Rotate the Jog dial to select “Midi Sync Out ?” (“?” flashes.), then press the [EXECUTE/YES] key.**  
The currently-selected MIDI sync signal type appears on the display. Press the [EXECUTE/YES] key to turn off the flashing “?” indication. The MIDI sync signal type indication flashes, and the indicator flashes indicating the SYNC OUT setting. The initial setting is “MTC” as shown below.

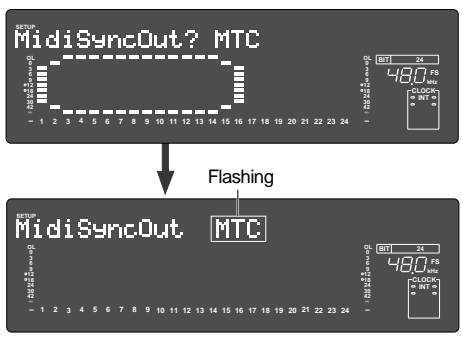

- (3) **Turn the Jog dial to select the desired MIDI sync signal.**  
Setting this parameter to “**CLK**” will select MIDI clock & Song Position Pointer. Setting the parameter to “**MTC**” (initial setting) will select MIDI time code. With the “**Off**” setting, no MIDI sync signal will be output.
- (4) **Press the [EXECUTE/YES] key.**  
The selected MIDI sync signal type is stored, and the recorder returns to the display with the flashing “?” indicator as shown in step 2.

To cancel the setting operation, or to exit SETUP mode after storing data, press the [STOP] button or the [EXIT/NO] key. Each time you press one of these keys, the recorder returns to the previous hierarchy level of the menu, and finally exits SETUP mode.

### Setting an MTC frame rate

The “**Setting an MTC frame rate**” menu enables you to set the frame rate for MTC output from the MIDI OUT connector of the recorder to an external MIDI device. If you have already set the type of MIDI sync output signal to “**MTC**,” you need to set the frame rate. Use the frame rate of MTC received by the external MIDI device (or sequence software).

- Initial setting: **[25]** (25 frames)
- Setting range of frame rate: **[24], [25], [29df], [29nd], [30df], [30nd]**
- \* You can set the value for each Program individually.
- \* The settings can be saved and loaded as part of the song data.
- \* The settings are maintained after you turn off the power to the recorder.

- (1) **While the recorder is stopped, press the [SETUP] key to enter SETUP mode.**
- (2) **Turn the Jog dial to select “Frame Rate ?” (“?” flashes), then press the [EXECUTE/YES] key.**  
The current frame rate setting appears on the display. Press the [EXECUTE/YES] key to turn off the flashing “?” character; the current setting flashes. The initial setting of “25” flashes as shown below.

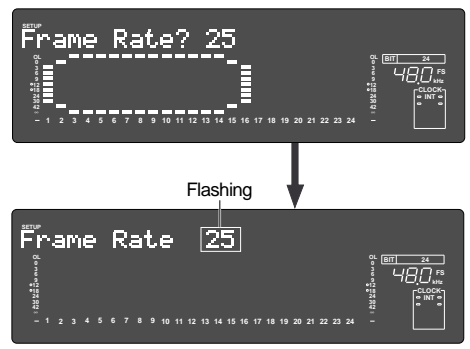

- (3) **Turn the Jog dial to enter the desired frame rate.**  
Rotating the **Jog** dial clockwise or counter-clockwise displays available frame rates as an alternative.

- (4) **Press the [EXECUTE/YES] key.**  
The selected frame rate is stored and the display returns to the indication with a flashing “?” that appeared in step 2.

*To cancel the setting operation, or to exit SETUP mode after storing data, press the [STOP] button or the [EXIT/NO] key. Each time you press one of these keys, the recorder returns to the previous hierarchy level of the menu, and finally exits SETUP mode.*

**<Note>:** There are no 29.97nd or 29.97df in the MTC standard.  
Use either 30nd or 30df unless you definitely need to synchronize the recorder with NTSC video.

### Setting an MTC offset value

The “**Setting an MTC offset value**” menu enables you to specify an offset time value - the difference between the time of MTC output from the recorder and the ABS 00M 00S 00F 00SF time. You need to specify this value if you have selected “**MTC**” for the “**Setting MIDI sync output signal**” menu.

With the initial setting of 00h 59M 57S 00F 00SF, for example, MTC of 59M 57S 00F 00SF is output at the ABS time 00M 00S 00F 00SF. You can also set an offset value from the 001bar 1beat 00clk value (bar/beat) on the Tempo Map. Refer to the next section for information on MTC Offset mode.

- Initial setting: [00H: 59M: 57S: 00F: 00SF]
- Setting range of offset time :  
00H: 00M: 00S: 00F: 00SF - 23H: 59M: 59S: 29F: 99SF
- \* You can set the value for each Program individually.
- \* The settings can be saved and loaded as part of the song data.
- \* The settings are maintained after you turn off the power to the recorder.

- (1) **While the recorder is stopped, press the [SETUP] key to enter SETUP mode.**
- (2) **Turn the Jog dial to select “MTC Offset?” (“?” flashes.), then press the [EXECUTE/YES] key.**  
The current offset value appears on the display. Pressing the [EXECUTE/YES] key turns off the flashing “?” character, and the value in seconds flashes. You can enter a value at the flashing digit. The number “57” of the initial setting “57S” flashes as shown below.

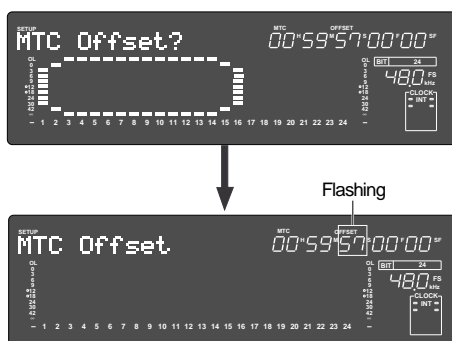

- (3) **Use the Shuttle dial to move the flashing cursor, and turn the Jog dial to enter the desired offset value.**

For example, if you rotate the Jog dial on the seconds digit up 59, turning the dial further will increase the number on the digit of minute by one.

- (4) **Press the [EXECUTE/YES] key.**  
The selected offset value is stored and the display returns to the indication with the flashing “?” that appeared in step 2.

*To cancel the setting operation, or to exit SETUP mode after storing data, press the [STOP] button or the [EXIT/NO] key. Each time you press one of these keys, the recorder returns to the previous hierarchy level of the menu, and finally exits SETUP mode.*

**<Note>:** For example, if you set MTC Offset mode to “ABS” (see the next section) and you wish to start the song from MTC’s 01H 00M 00S 00F, you may wish to set a preroll of three seconds with an MTC offset of 00H 59M 57S 00F.

### Setting Offset mode

If you have selected “**MTC**” in the “**Setting Offset mode**” menu, you need to select MTC Offset mode. This menu enables you to determine whether the specified MTC is output at ABS 00H 00M 00S 00F or at 001bar 1beat 00clk (bar/beat) of the Tempo Map.

#### <Notes>

- As an example, if you set MTC Offset mode to “ABS” and you wish to start the song from MTC’s 1H 00M 00S 00F, you may want to set a preroll of three seconds with MTC offset of 00H 59M 57S 00F. If you select “BAR ♪” as the MTC Offset mode, a preroll of two measures is automatically set. Use 01H 00M 00S 00F; do not set a preroll value.
- If you set Offset mode to “BAR ♪” and use MTC to synchronize sequence software on the computer, the tempo of the sequencer may sometimes slip gradually. This is because the tempo of the recorder and the tempo of the software are slightly different even if both use the same tempo. Some sequence software can read the tempo output from the recorder correctly. We recommend that you use the tempo of the recorder on the sequence software. No such problems will occur if the sequence software synchronizes the recorder via MIDI clock, instead of MTC.

- Initial setting: [ABS]
- Offset mode option: [ABS], or [Bar ♪]
- \* You can set the mode for each Program individually.
- \* The settings can be saved and loaded as part of the song data.
- \* The settings are maintained after you turn off the power to the recorder.

- (1) **While the recorder is stopped, press the [SETUP] key to enter SETUP mode.**
- (2) **Turn the Jog dial to select “Offset Mode ?” (“?” flashes.), then press the [EXECUTE/YES] key.**  
The current offset mode appears on the display.

Pressing the [EXECUTE/YES] key to turn off the flashing “?” character. The Offset mode indicator flashes. With the initial setting, “ABS” flashes as shown below.

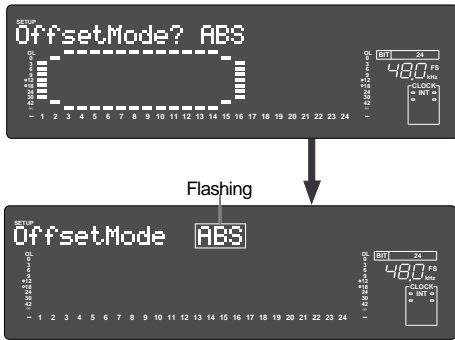

- (3) **Use the Jog dial to select the desired Offset mode.**  
Rotating the Jog dial clockwise or counter-clockwise will alternately show a flashing “ABS” and “Bar J”. If you select “ABS”, the specified MTC offset time is output at ABS 00H 00M 00S 00F. If you select “Bar J”, the specified MTC offset time is output at 001bar 1beat 00clk of the Tempo Map.
- (4) **Press the [EXECUTE/YES] key.**  
The selected offset mode is stored and the display returns to the indication with flashing “?”.

*To cancel the setting operation, or to exit SETUP mode after storing data, press the [STOP] button or the [EXIT/NO] key. Each time you press one of these keys, the recorder returns to the previous hierarchy level of the menu, and finally exits SETUP mode.*

### Setting the Slave type

The “Setting the Slave type” menu enables you to setup how recorder should function after chase lock, when recorder is set to sync externally in “slave mode ON” by the previously mentioned “Setting the slave mode.”

- Initial setting: **[Vari]**
- Option: **[Vari], [Free], [Once]**
- \* You can set the parameter for each Program individually.
- \* The settings can be saved and loaded as part of the song data.
- \* The settings are maintained after you turn off the power to the recorder.
- \* The Program is automatically checked before the operation.
- \* The sampling rate is automatically checked before the operation.

- (1) **While the recorder is stopped, press the [SETUP] key to enter SETUP mode.**
- (2) **Turn the Jog dial to select “Slave Type ?” (“?” flashes.), then press the [EXECUTE/YES] key.**  
The current Slave type appears on the display. Pressing the [EXECUTE/YES] key turns off the flashing “?” character, and the Slave type indicator flashes. With the initial setting, “Vari” flashes as shown below.

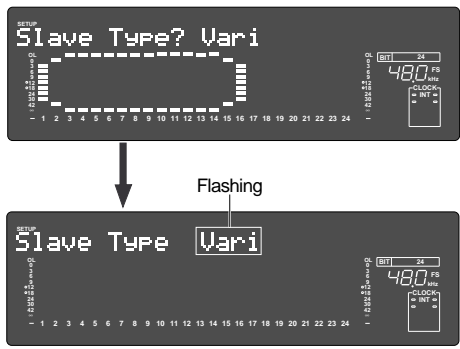

- (3) **Use the Jog dial to select the desired Slave type, and press the [EXECUTE/YES] key.**  
Rotating the Jog dial clockwise and counter-clockwise will cause the “Vari”, “Free” and “Once” indicators to flash in sequence.

<b>Vari</b> (Default)	With the slave mode to “ON”, the recorder synchronizes only to incoming MTC. After it locks to MTC, it continues to chase MTC by varying the speed within the inaudible deviation range. If it unlocks to the MTC, it automatically rebase MTC.
<b>Free</b>	With the slave mode to “ON”, once the recorder locks to incoming MTC, it runs with the internal clock reference. If it unlocks to MTC, it automatically rebase MTC.
<b>Once</b>	With the slave mode to “ON”, once the recorder locks to incoming MTC, it stops chasing and runs with the internal clock reference. It does not rebase MTC even if it unlocks to MTC.

- (4) **Press the [EXECUTE/YES] key.**  
The selected Slave type is stored, and “?” flashes.

*To cancel the setting operation, or to exit SETUP mode after storing data, press the [STOP] button or the [EXIT/NO] key. Each time you press one of these keys, the recorder returns to the previous hierarchy level of the menu, and finally exits SETUP mode.*

**<Note>:** You need to input MTC from an external device to the recorder with any Slave type.

**<Note>:** When you set the Slave type, the Vari Pitch function is automatically disabled. (The “VARI PITCH” indicator turns off.)

**<Notes>:** The recorder re-chase window is fixed to ten frames. That is, if an offset between the master device and slave device exceeds ten frames, the recorder interprets that as out of sync, and tries to chase and lock to MTC sent from the master device. (This operation is called “re-chasing.”) During the re-chase operation, audio output is muted. If the slave machine slips with MTC from the master device by less than ten frames, the slave machine continues running while recognizing the slippage.



### Setting the Record Protect function

The recorder features the Record Protect function, which is similar to the function of record-protect tabs on cassette tapes. The “**Setting the Record Protect function**” menu allows you to turn the Record Protect function on and off.

When this function is turned on, you cannot record, paste, or erase data. Use this function to protect your precious data from being erased accidentally.

- Initial setting: [Off]
- Option: [Off] or [On]
- \* You can turn the function on and off for each Program individually.
- \* The settings can be saved and loaded as part of the song data.
- \* The settings are maintained after you turn off the power to the recorder.
- \* The Program is automatically checked before the operation.

- (1) While the recorder is stopped, press the [SETUP] key to enter SETUP mode.
- (2) Turn the Jog dial to select “Rec Protect ?” (“?” flashes), then press the [EXECUTE/YES] key. The current setting appears on the display. Pressing the [EXECUTE/YES] key turns off the flashing “?” character, and the recording enabled/disabled indicator flashes. With the initial setting, “Off” flashes as shown below.

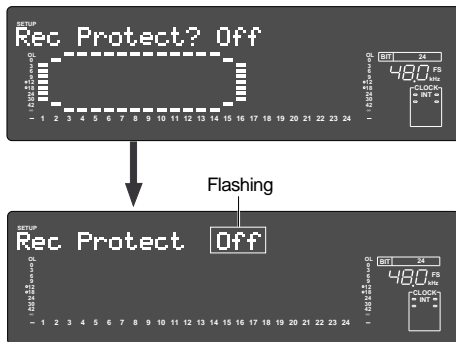

- (3) Use the Jog dial to enable or disable recording. Rotating the Jog dial clockwise and counter-clockwise will flash “On” and “Off” alternately. Selecting “Off” enables recording; you can record, paste, and erase data. Selecting “On” disables recording; and you cannot record, paste, or erase data.

**<Note>:** When recording is disabled (On) and you try to record, paste, or erase data, the recorder displays “Protected” for a second, indicating that you cannot perform the operation. To perform the operation, you need to enable recording (Off).

- (4) Press the [EXECUTE/YES] key.

To cancel the setting operation, or to exit SETUP mode after storing data, press the [STOP] button or the [EXIT/NO] key. Each time you press one of these keys, the recorder returns to the previous hierarchy level of the menu, and finally exits SETUP mode.

### Setting digital input

In the “**Setting a digital input**” menu, the signal to be input to the [DATA INPUT] connector of the recorder can be set for either digital signals (adat digital signal or S/P DIF digital signal) or analog signals, and also setup of the digital in clock (synchronous or asynchronous).

By using this function, signals from external digital equipment (CD, MD, DAT, adat digital mixer) can be digitally recorded.

When selecting the clock, there are the “**Async**” and “**Sync**” modes; either should be selected depending on the application. If it is set to “**Async**” mode, the later explained “**Clock Sel?**” (Setting the operating clock) should be setup in accordance to the application.

- Initial setting: [Analog]
- Assignable digital signal/setting digital in-clock: [adat: Async], [adat: Sync], [SPDIF: Async], [SPDIF: Sync], [Analog]
- \* This setting is shared by all Programs in the same disk.
- \* The settings cannot be saved and loaded as part of the song data.
- \* The settings are maintained after you turn off the power to the recorder.

#### <Function of the [DATA INPUT] connectors>

##### <Setup for analog signals>

If the digital input is set up for Analog (Initial setting), digital signals cannot be input at [DATA INPUT] 1-8, 9-16 and 17-24 of the D2424LVmkII.

##### <Setup for S/P DIF digital signals>

If the digital input is set up for S/P DIF (Async or Sync), only [DATA INPUT] 1-8 can be used. S/P DIF digital signals input to [DATA INPUT] 1-8 will be assigned and recorded in tracks 1 and 2 of D2424LVmkII.

##### <Setup for adat digital signals>

If the digital input is set up for adat (Async or Sync), all [DATA INPUT] connectors can be used.

Adat digital signals input to [DATA INPUT] 1-8 will be assigned and recorded in tracks 1-8; the signals to [DATA INPUT] 9-16 in tracks 9-16; and the signals to [DATA INPUT] 17-24 in tracks 17-24.

**Note:** The [DATA INPUT] connectors do not support 96kHz FS adat digital signals.

- (1) While the recorder is stopped, press the [SETUP] key to enter SETUP mode.
- (2) Turn the Jog dial to select “D.in ?” (“?” flashes), then press the [EXECUTE/YES] key. When “D.in?” (“?” flashes) is selected, the presently set digital input content will be shown. The flashing “?” is extinguished when the [EXECUTE/YES] key is pressed and the digital input setting will change from lighting to flashing. In the initial setting, “Analog” will flash as shown below.

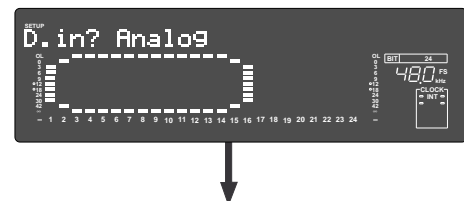

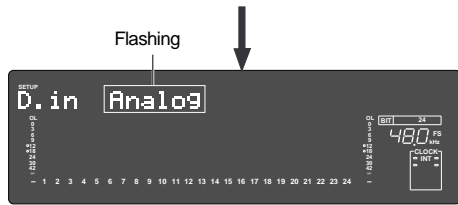

**(3) Select the desired digital signal and digital-in clock with the Jog dial.**

In addition to “Analog”, “adat: Async”, “adat: Sync”, “SPDIF: Async” or “SPDIF: Sync” can be selected.

“Async”/“Sync” which is displayed together with the digital signal (S/P DIF or adat) must be selected to whether the system is to be synchronized or not with the digital-in clock.

If you do not wish to synchronize the system with digital in, select “Async” and, if it is to be synchronized, select “Sync”.

**(4) After selecting, press the [EXECUTE/YES] key again.**

The selected digital signal is registered and “?” in Step-2 will return to flashing.

When the digital input is setup and the correct digital signal is input, “DIGITAL” will light up in the display.

If set to synchronous mode of “adat: Sync” or “SPDIF: Sync” and locked to the external digital signal, “EXT” will simultaneously light up.

*To cancel the setting operation, or to exit SETUP mode after storing data, press the [STOP] button or the [EXIT/NO] key. Each time you press one of these keys, the recorder returns to the previous hierarchy level of the menu, and finally exits SETUP mode.*

**<Notes>**

- Should “DIGITAL” flash in the display, check the connecting cable between the external equipment and the external equipment setting.
- When the digital input is set up for “adat” (Async or Sync), should any one among the three [DATA INPUT] (1-8, 9-16, 17-24) be locked, “DIGITAL” will light up in the display. In such a case, tracks not locked will be automatically set for analog input. By using this function, for example, if analog signals are input to tracks 1-8 and adat digital signals to tracks 9-16 and 17-24, a total of 24 tracks can be recorded simultaneously.

**Setting digital output**

By using the “Setting a digital output” menu, the type of digital signal to be output to external digital equipment from the [DATA OUTPUT] connector (1-8, 9-16, 17-24) of this recorder, can be setup.

Also, by using this function, sound recorded in this recorder can be sent to external digital equipment (MD, DAT, adat, digital mixer) in direct digital signals.

- Initial setting: [adat]
- Assignable digital signal:  
[adat] (adat digital signal)  
[SPDIF] (S/P DIF digital signal)
- \* This setting is shared by all Programs in the same disk.
- \* The settings cannot be saved and loaded as part of the song data.
- \* The settings are maintained after you turn off the power to the recorder.

**<Function of the [DATA OUTPUT] connectors>**

**<Setup for S/P DIF digital signals>**

When the digital output is set up for S/P DIF, all [DATA OUTPUT] connectors can be used.

Signals of tracks 1-2 are output from [DATA OUTPUT] 1-8; the signals of tracks 3-4 from [DATA OUTPUT] 9-16; and signals from tracks 5-6 from [DATA OUTPUT] 17-24.

**<Setup for adat digital signals>**

When the digital output has also been setup for adat, all [DATA OUTPUT] connectors can be used.

Signals of tracks 1-8 is output from [DATA OUTPUT] 1-8; the signals of tracks 9-16 from [DATA OUTPUT] 9-16; and signals from tracks 17-24 from [DATA OUTPUT] 17-24. **Note:** The [DATA OUTPUT] connectors do not support 96kHz FS adat digital signals.

**(1) While the recorder is stopped, press the [SETUP] key to enter SETUP mode.**

**(2) Turn the Jog dial to select “D. out ?” (“?” flashes), then press the [EXECUTE/YES] key.**

The current digital output signal appears on the display.

Pressing the [EXECUTE/YES] key turns off the flashing “?” character, and setting of the digital output signal flashes. With the initial setting, “adat” flashes as shown below.

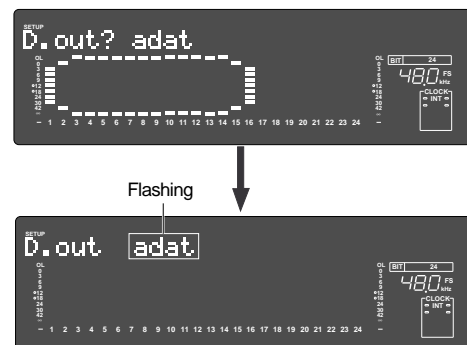

- (3) **While the “adat” is flashing, turn the Jog dial.**  
 “SPDIF” can be selected in addition to “adat”.  
 Select “adat” if the adat digital signal (8 tracks) is to be output, and “SPDIF” if the S/P DIF digital signal (2 tracks) is to be output.
- (4) **After selecting the digital output signal, press the [EXECUTE/YES] key.**  
 The selected digital output signal will be registered and the flashing “?” in Step-2 will return to flashing.

*To cancel the operation, or to restore the setting obtained prior to the [EXECUTE/YES] key press, press the [STOP] button or the [EXIT/NO] key. Each time you press one of these keys, the recorder returns to the previous hierarchy level of the menu, and finally exits SETUP mode and displays the previous Time Base.*

### Setting BAR/BEAT resolution mode

The “**Setting BAR/BEAT resolution mode**” menu enables you to turn BAR/BEAT resolution mode on and off. The initial setting is “Off.” When you turn this mode on, the CLK (clock) digits will be always round off to 00 and be stored in the memory key while the recorder is using the BAR/BEAT/CLK Time Base. That is, beat resolution is used. Using this function allows you to automatically store a beat-resolution value of the CLIPBOARD IN/OUT points and other points in real-time. (Press the STORE key, then the corresponding memory key while playing the recorder.) Therefore, it is very convenient when you perform the Copy & Paste or Move & Paste operation in beat-resolution.

For example, assume that you have stored the value for 001bar 1 ♪ 46 clk as the CLIPBOARD IN point, and the value for 002bar 4 ♪ 51 clk as the CLIPBOARD OUT point.  
 These values will be used as they are if BAR/BEAT resolution mode is turned off. However, the mode is turned on, the following values will be stored instead. The following example has a time signature setting of 4/4.

**001bar 1 ♪ 46 clk -> 001bar 1 ♪ 00 clk**  
 (A clk value of 46 will be rounded off.)

**002bar 4 ♪ 51 clk -> 003bar 1 ♪ 00 clk**  
 (A clk value of 51 will be rounded up.)

- Initial setting: [Off]
- Options: [On] or [Off]
- \* This setting is shared by all Programs in the same disk.
- \* The settings cannot be saved and loaded as part of the song data.
- \* The settings are maintained after you turn off the power to the recorder.

- (1) **While the recorder is stopped, press the [SETUP] key to enter SETUP mode.**
- (2) **Turn the Jog dial to select “Resolution ?” (“?” flashes), then press the [EXECUTE/YES] key.**  
 The current BAR/BEAT resolution mode setting appears on the display.  
 Pressing the [EXECUTE/YES] key turns off the flashing “?” character, and the BAR/BEAT resolution mode setting flashes. With the initial setting, “Off” flashes as shown below.

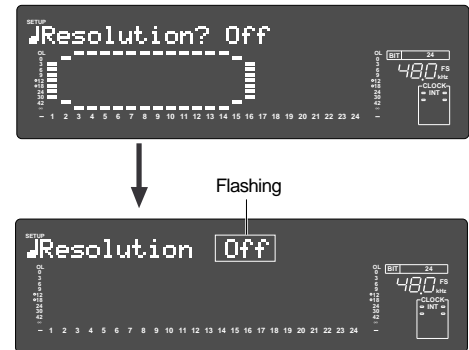

- (3) **Use the Jog dial to turn the mode “On” or “Off”.**  
 When you turn the Jog dial clockwise and counter-clockwise, “On” and “Off” flash alternately. Selecting “On” turns BAR/BEAT resolution mode on, and selecting “Off” turns BAR/BEAT resolution mode off.
- (4) **Press the [EXECUTE/YES] key.**  
 The selected mode setting is stored, and “?” flashes.

*To cancel the operation, or to restore the setting obtained prior to the [EXECUTE/YES] key press, press the [STOP] button or the [EXIT/NO] key. Each time you press one of these keys, the recorder returns to the previous hierarchy level of the menu, and finally exits SETUP mode and displays the previous Time Base.*

### Setting the MIDI device number

The “**Setting the MIDI device number**” menu enables you to set the recorder device ID number required to control the unit from a sequence software using MMC (MIDI Machine Control) or FEX (Fostex System Exclusive Message).

The transmit device ID links to this setting. You can set the device ID from “00” to “99”.

However, if the device ID number of the message the recorder receives is “7F”, the recorder will recognize it to perform the corresponding operation, regardless of its device ID setting.

- Initial setting: **[00]**
- Options: **[00] ~ [99]**

- \* This setting is shared by all Programs in the same disk.
- \* The settings cannot be saved and loaded as part of the song data.
- \* The settings are maintained after you turn off the power to the recorder.

- (1) **While the recorder is stopped, press the [SETUP] key to enter SETUP mode.**
- (2) **Turn the Jog dial to select “Device ID?” (“?” flashes), then press the [EXECUTE/YES] key.**  
The current MIDI device ID number appears on the display.  
Pressing the [EXECUTE/YES] key turns off the flashing “?” character, and the MIDI device ID number flashes.  
With the initial setting, “00” flashes as shown below.

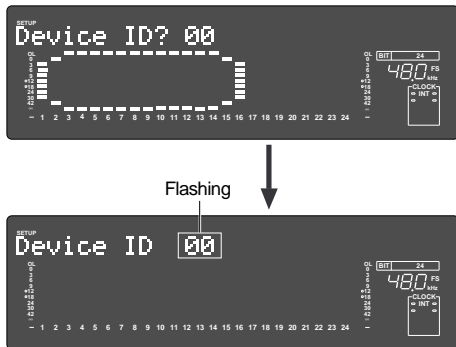

- (3) **Use the Jog dial to set the desired MIDI device ID number.**  
Turning the Jog dial clockwise increments the value, and turning it counter-clockwise decrements the value.
- (4) **Press the [EXECUTE/YES] key.**  
The MIDI device ID number is stored, and “?” flashes.

*To cancel the operation, or to restore the setting obtained prior to the [EXECUTE/YES] key press, press the [STOP] button or the [EXIT/NO] key. Each time you press one of these keys, the recorder returns to the previous hierarchy level of the menu, and finally exits SETUP mode and displays the previous Time Base.*

### Setting the Operating Clock

The “**Setting the Operating Clock**” menu is used to setup the operating clock of the recorder.

If digital input is set to asynchronous mode of “**adat: Async**” or “**SPDIF: Async**” in the previous “**D. in?**” (Digital input setting), whether this recorder is to operated by its internal clock or synchronized to the word clock signal from the external digital equipment should be selected when recording in digital from external digital equipment (DAT, adat, CD, MD, etc.). The initial setting is set to synchronize to the internal clock.

The setup item “**Video**” is effective if an optional Model 8346 TC/SYNC card is installed.  
For details, refer to the “**APPENDIX.**”

- Initial setting: **[Int.]**
- Option: **[Int.]** (Internal clock)  
**[Auto]**  
**[Word]**  
**[Video]** (This item will be effective if the optional Model 8346 TC/SYNC card is installed in this recorder.)

- \* This setting is shared by all Programs in the same disk.
- \* The settings cannot be saved and loaded as part of the song data.
- \* The settings are maintained after you turn off the power to the recorder.

- (1) **While the recorder is stopped, press the [SETUP] key to enter SETUP mode.**
- (2) **Turn the Jog dial to select “Clock Sel ?” (“?” flashes), then press the [EXECUTE/YES] key.**  
A flashing “?” will extinguish by pressing the [EXECUTE/YES] key and the operating clock information that was lit will be flashing.  
Initial setting, it will show “Int.”

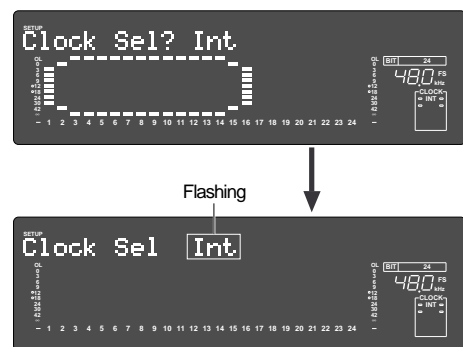

- (3) **With the Jog dial, select the operating clock.**  
If “**Int.**” (initial setting) is selected, the recorder will operate using the internal clock.  
If “**Auto**” is selected, the recorder will sync to an external digital signal.  
If “**Word**” is selected, the recorder will sync to an external word clock signal.
- (4) **Press the [EXECUTE/YES] key.**  
The selected operating clock will register and “?” in step-2 above, will flashes.  
Refer to the chart of next page in regards to “Digital input setting” and “Operating clock setting.”



To cancel the operation, or to restore the setting obtained prior to the [EXECUTE/YES] key press, press the [STOP] button or the [EXIT/NO] key. Each time you press one of these keys, the recorder returns to the previous hierarchy level of the menu, and finally exits SETUP mode and displays the previous Time Base.

[D. in ?] setting	SPDIF :Async adat :Async		SPDIF :Sync adat :Sync	
	clock received from WORD IN	no clock received from WORD IN	clock received from WORD IN	no clock received from WORD IN
<b>Int</b>	Regardless of receiving or not receiving word clock from WORD IN, the recorder is referenced to the internal clock. When the recorder receives correct digital signals, the "DIGITAL" indicator lights in the display.		Regardless of receiving or not receiving word clock from WORD IN, the recorder synchronizes to the external S/P DIF digital signal. When the recorder receives correct digital signals, the "DIGITAL" and "EXT" indicators light in the display. When Digital In is set to a SYNC mode, if you try to select "Clock Sel?" menu, The display will show "Clock Sel D.in!" (indicating that the clock is set to Digital In!) and the recorder ignores your operation.	
<b>Auto</b>	When receiving word clock from WORD IN, the recorder automatically synchronizes to the incoming clock, while the "DIGITAL" and "EXT" indicators light in the display.	When no word clock is received, the recorder is referenced to the internal clock, while the "EXT" indicator flashes.		
<b>Word</b>	When receiving word clock from WORD IN, the recorder synchronizes to the incoming clock, while the "DIGITAL" and "EXT" indicators light in the display.	When no word clock is received, the "EXT" indicator flashes showing that the recorder cannot be locked.		
<b>Video</b>	Available only when installing the optional Model 8346 TC/SYNC card. If you try to select "Video," "Void w/o 8346" is displayed and you cannot select it. See the appendix of the Reference manual for details.			

### Checking the number of track events

The "Checking the number of track events" menu enables you to check the number of events on each track. Each track (including Additional tracks) of recorder Programs consists of consecutive audio files (and "zero" files). The number of events represents the total number of audio files and 0 files. Each track can contain up to 512 events.

If you are editing a song of typical length (about six minutes), repeated editing operation does not usually cause this maximum number to be exceeded. (Exceeding this limit is called "event number overflow.") Even a 20-minute song will not cause event number overflow. This is because the recorder system always optimizes the data structure by keeping the number of events low. However, if a recording on a track is scattered in different areas of the disk, or if you have made a very long recording on a single track and performed many edits, you should be wary of "event number overflow."

To avoid this problem, use the "Checking the number of track events" menu to check the number of events on each track prior to recording or editing.

- (1) While the recorder is stopped, press the [SETUP] key to enter SETUP mode.
- (2) Turn the Jog dial to select "No Of Event?" ("?" flashes), and then press the [EXECUTE/YES] key. The screen changes as follows, indicating the number of events on track 1. (In this example, track 1 includes five events.)

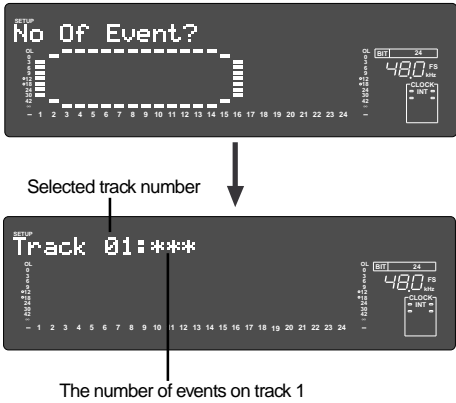

- (3) Use the Jog dial to select another (01-24) to check the number of events on the corresponding track.
- (4) Press the [EXIT/NO] key or the [STOP] button repeatedly to exit SETUP mode.

To cancel the operation, or to restore the setting obtained prior to the [EXECUTE/YES] key press, press the [STOP] button or the [EXIT/NO] key. Each time you press one of these keys, the recorder returns to the previous hierarchy level of the menu, and finally exits SETUP mode and displays the previous Time Base.

\* For more information on audio files and events, refer to the "Audio file and event" section of the "Before Starting" chapter.

### Setup of the Auto EE mode

At the "Setup of the Auto EE mode" menu, you must set up whether it should be automatically set to "ALL INPUT monitor" or not when D2424LVmkII is in the STOP mode.

- Initial setting: [Off]
- Device ID: [Off] or [On]

- \* This setting is shared by all Programs in the same disk.
- \* The settings cannot be saved and loaded as part of the song data.
- \* The settings are maintained after you turn off the power to the recorder.

- (1) While the recorder is stopped, press the [SETUP] key to enter SETUP mode.
- (2) Turn the Jog dial to select "Auto EE Mode ?" ("?" flashes), then press the [EXECUTE/YES] key. A flashing "?" will extinguish by pressing the [EXECUTE/YES] key and the auto EE mode information that was lit will be flashing. Initial setting, it will show "Off".

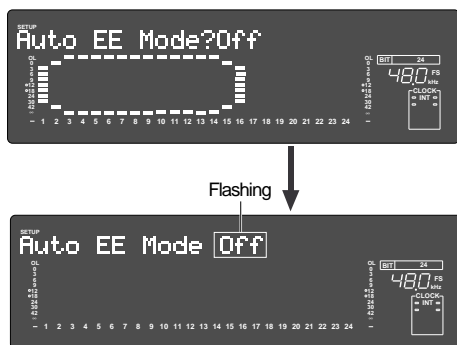

- (3) With the Jog dial, select the auto EE mode.
- (4) After selecting "On" or "Off," press the [EXECUTE/YES] key again. The selected On/Off will be registered and the Step-2 "?" will return to flashing.
- (5) Press the [EXIT/NO] key or the [STOP] button repeatedly to exit SETUP mode.

To cancel the operation, or to restore the setting obtained prior to the [EXECUTE/YES] key press, press the [STOP] button or the [EXIT/NO] key. Each time you press one of these keys, the recorder returns to the previous hierarchy level of the menu, and finally exits SETUP mode and displays the previous Time Base.

### Setup of the Foot switch function

At the "Setup of the foot switch function" menu, functions of a foot switch connected to the FOOT SW jack must be set up.

Functions of the foot switch are, manual punch in/out or PLAY-STOP of D2424LVmkII. Initially, this is set to the "Punch in/out function" explained in "Using the foot switch for manual punch in/out," page "43". You can change this to PLAY-STOP or PLAY of the recorder if you so wish.

- Initial setting: [Punch IO]
- Options: [Punch IO] (Punch in/out function)  
[PLY/STP] (Play/stop function)  
[PLAY] (Play function)

- \* This setting is shared by all Programs in the same disk.
- \* The settings cannot be saved and loaded as part of the song data.
- \* The settings are maintained after you turn off the power to the recorder.

- (1) While the recorder is stopped, press the [SETUP] key to enter SETUP mode.
- (2) Turn the Jog dial to select "Foot SW ?" ("?" flashes), then press the [EXECUTE/YES] key. A flashing "?" will extinguish by pressing the [EXECUTE/YES] key and the foot switch function information that was lit will be flashing. Initial setting, it will show "Punch IO".

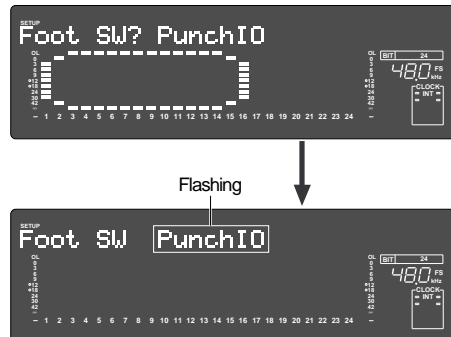

- (3) Select the desired function by rotating the Jog dial.
- (4) After selecting the function, press the [EXECUTE/YES] key again. The selected foot switch function will be registered and the Step-2 "?" will return to flashing.
- (5) Exit from the SETUP mode by pressing the [EXIT/NO] key (or [STOP] button).

To cancel the operation, or to restore the setting obtained prior to the [EXECUTE/YES] key press, press the [STOP] button or the [EXIT/NO] key. Each time you press one of these keys, the recorder returns to the previous hierarchy level of the menu, and finally exits SETUP mode and displays the previous Time Base.

### Setup of the stop function at the mark

At the “**Setup of the stop function at the mark point**” menu, this sets whether or not D2424LVmkII should automatically stop at the preset mark point (=locate point) during playback.

- Initial setting: [Off]
- Options: [OFF] or [On]

- \* This setting is shared by all Programs in the same disk.
- \* The settings cannot be saved and loaded as part of the song data.
- \* The settings are maintained after you turn off the power to the recorder.

- (1) While the recorder is stopped, press the [SETUP] key to enter SETUP mode.
- (2) Turn the Jog dial to select “Mark Stop MD?” (“?” flashes), then press the [EXECUTE/YES] key. A flashing “?” will extinguish by pressing the [EXECUTE/YES] key and the stop function at the mark point information that was lit will be flashing. Initial setting, it will show “Off”.

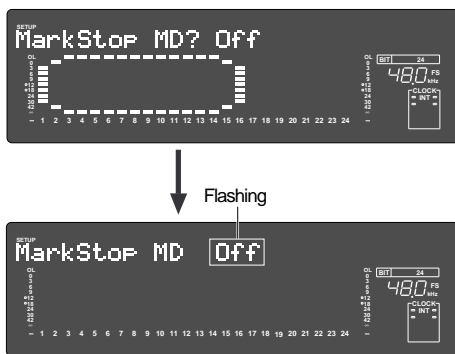

- (3) Select "On" or "Off" with the Jog dial and press the [EXECUTE/YES] key again. The selected stop function will be registered and the Step-2 "?" will return to flashing.
- (4) Exit from the SETUP mode by pressing the [EXIT/NO] key (or the [STOP] button).

*To cancel the operation, or to restore the setting obtained prior to the [EXECUTE/YES] key press, press the [STOP] button or the [EXIT/NO] key. Each time you press one of these keys, the recorder returns to the previous hierarchy level of the menu, and finally exits SETUP mode and displays the previous Time Base.*

### Setup of input/output Balance/Unbalance

Whether the D2424LVmkII rear panel analog input/output connectors should be set to balanced or unbalanced lines can be setup at the “**Setup of input/output balance/unbalance**” menu. Initially, it is set for unbalance but can be set to balanced input/output. Because the setup content is registered in the D2424LVmkII internal System ROM, it will be held even though the current drive E-IDE hard disk is replaced.

- Initial setting: [UNBAL] (Unbalanced/-10dBV)
- Option: [UNBAL] (Unbalanced/-10dBV) or [BAL] (Balanced/+4dBu)

- \* The settings cannot be saved and loaded as part of the song data.
- \* The settings are maintained after you turn off the power to the recorder.

- (1) While the recorder is stopped, press the [SETUP] key to enter SETUP mode.
- (2) Turn the Jog dial to select “BAL/UNBAL ?” (“?” flashes), then press the [EXECUTE/YES] key. The display will change as shown below and the presently setup item will be displayed. The blinking “?” will disappear when the [EXECUTE/YES] key is pressed and the lighted item will change to flashing. “UNBAL” will flash in the initial setting.

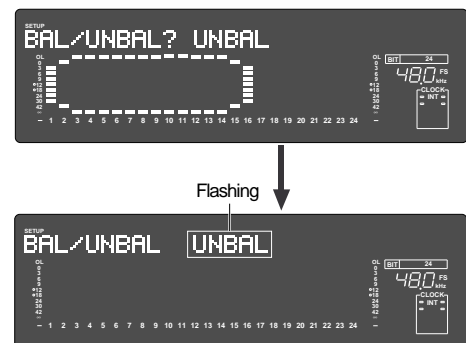

- (3) Select the “BAL” or “UNBAL” with the Jog dial, then press the [EXECUTE/YES] key again. The selected item will be registered and “?” in Step-2 will return to flashing.
- (4) Exit from the SETUP mode by pressing the [EXIT/NO] key (or [STOP] button).

*To cancel the operation, or to restore the setting obtained prior to the [EXECUTE/YES] key press, press the [STOP] button or the [EXIT/NO] key. Each time you press one of these keys, the recorder returns to the previous hierarchy level of the menu, and finally exits SETUP mode and displays the previous Time Base.*

### Drive Format Information

Format information of the current drive presently installed can be checked by using the “**Drive Format Information**” menu. Should any trouble occur in the recorder, providing the information obtained here to our nearest Fostex Service Station will be of great help in giving quick service. The following items will be displayed and can be confirmed.

1. **Manufacture / Model of the currently installed hard disk.**
2. **Format method**
3. **Last day of formatting in standard type**
4. **Format type**
5. **Simultaneously recordable number of tracks**
6. **Number of bits at formatting**
7. **Sampling frequency at formatting**
8. **Present number of programs**
9. **Present number of free blocks**
10. **Audio file / maximum number of events and its program No.**
11. **Maximum number of events of the time code and its program number**
12. **Specific capacity of the drive**
13. **Remaining capacity of the drive**
14. **Present software version**
15. **Present multiple undo function mode on/off**

- (1) While the recorder is stopped, press the [SETUP] key to enter SETUP mode.
- (2) Turn the Jog dial to select “Drive Info?” (“?” flashes), and then press the [EXECUTE/YES] key. First, the manufacturer / model of the currently installed hard disk will scroll and displayed.

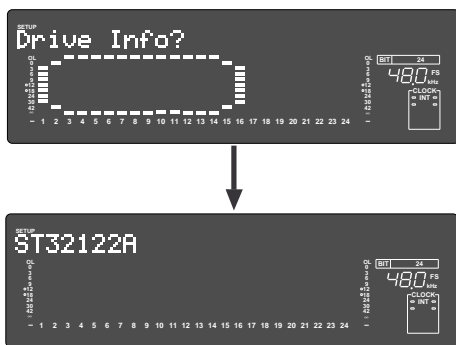

- (3) As the Jog dial is rotated, information is displayed one after the other (See display examples).

- This indicates that the formatting method is standard. In addition to “Standard” formatting method, “Quick” or “Erase” will be displayed.



- The last date in when it was formatted in standard will be displayed. The disk formatted by “Quick” will be displayed as “-,-,-,-”.



- This indicates that the format type was linear. In addition to “Linear”, the display can also show “Backup”, “LP”, “ADAC” or “Illegal FM”.

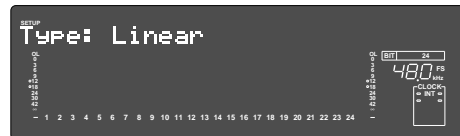

- This indicates that simultaneous recordable number of tracks is 24. In addition to “24 Trk”, the display can also show “8 Trk”, “4 Trk” or “16 Trk”.



- This indicates that the recorder is formatted in 24 bits. In addition to “24”, the display can also show “16” and “12”.



- This indicates that it is formatted in FS=48kHz. In addition to “48kHz”, the display can also show “44.1kHz”, “96kHz” or “88.2kHz”.



- This indicates that three programs exist.



- This indicates that the number of free blocks are five.



- This indicates that the maximum figure is 5 for the number of audio file / event and that this program is PGM01.



- This indicates that the specific capacity of this drive is 2112MB.

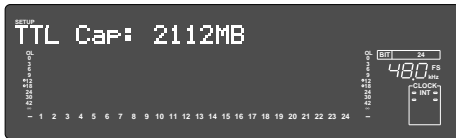

- This indicates that the remaining capacity (REMAIN) of the drive is 1618MB.



- This indicates that the figure is "0" for the time code number of events and that program is PGM01.



- This indicates the name and software version of the model that formatted the current hard disk.



- The ON/OFF switching of multiple undo function set at format of the current drive will be displayed. The display below indicates that the multiple undo function of the current drive presently in use is ON.



## Drive Setting

In D2424LVmkII, in addition to the current drive (E-IDE hard disk) for recording/playback/editing, by installing the optional Model 9044 (BAY+CADDY), an E-IDE hard disk.

In the "Drive setting" menu, these drives can be selected in accordance to the use. This is especially convenient to check the song data saved in the backup drive. Even though a multiple number of drives are used, the D2424LVmkII will normally start up from the current drive by re-switching on the power.

### <Notes>

By switching the drive setting to "IDE2," the saved song data can be confirmed by playing it back. Since this playback is only to the extent of confirming the saved data, it could create drop outs if 24 channels are played back.

The following operations cannot be executed when the drive is switched to "backup drive."

- \* Save/load of song data
- \* Setup of rhythm
- \* Recording
- \* Creating a new program
- \* Deleting a program
- \* Copy & paste and Move & paste
- \* Erase
- \* Track exchange
- \* Multiple undo
- \* Setup of tempo
- \* ON/OFF of metronome function
- \* Setup of permission or denial of recording

If power to this recorder is switched again, the drive will automatically switch to current drive (E-IDE).

- (1) While the recorder is stopped, press the [SETUP] key to enter SETUP mode.
- (2) Turn the Jog dial to select "Drive Sel.?" ("?" flashes), and then press the [EXECUTE/YES] key. The current setting will start flashing which indicates it is ready to change setting. In the case of initial setting it will show "IDE1."

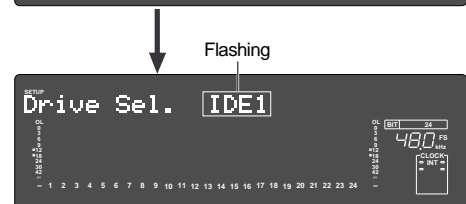

- (3) With the Jog dial, choose either "IDE1" or "IDE2" you want.
- (4) Press the [EXECUTE/YES] key after choosing the setting you want.

To cancel the operation, or to restore the setting obtained prior to the [EXECUTE/YES] key press, press the [STOP] button or the [EXIT/NO] key. Each time you press one of these keys, the recorder returns to the previous hierarchy level of the menu, and finally exits SETUP mode and displays the previous Time Base.



### Setup of the display contrast level

The contrast level of the D2424LVmkII display can be setup.

Because this setup content will be registered in the D2424LVmkII internal System ROM, it will be held even though the current drive hard disk is replaced.

- Initial setting : Level "6"
- \* Range which can be setup : Level "0" - Level "12"  
(Can be set in one step increments.)
- \* Setup content can be saved/loaded as song data.

- (1) While the recorder is stopped, press the [SETUP] key to enter SETUP mode.
- (2) Turn the Jog dial to select "Contrast ?" ("?" flashes), then press the [EXECUTE/YES] key. The display will change as shown below and the currently setup contrast level will be displayed (Initial setting is "06"). The flashing "?" will disappear when the [EXECUTE/YES] key is pressed and the currently set figure will flash.

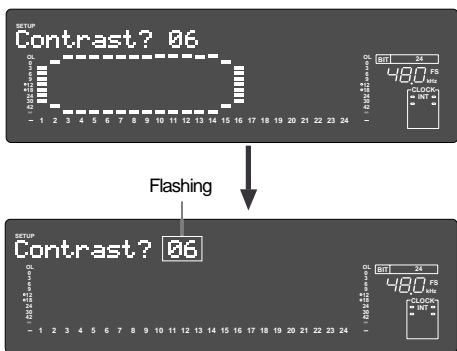

- (3) Select the desired contrast level by rotating the Jog dial, then press the [EXECUTE/YES] key. The contrast level can be selected in the 0-12 range. After selecting, the selected drive will be setup by pressing the [EXECUTE/YES] key.
- (4) Exit from the SETUP mode by pressing the [EXIT/NO] key (or [STOP] button).

To cancel the operation, or to restore the setting obtained prior to the [EXECUTE/YES] key press, press the [STOP] button or the [EXIT/NO] key. Each time you press one of these keys, the recorder returns to the previous hierarchy level of the menu, and finally exits SETUP mode and displays the previous Time Base.

### Setup of 0 file recording function

Whether or not a "0 file" should be recorded is setup with the "Setup of 0 file recording function" menu.

Normally, at recording adat or S/P DIF digital signals, if about one second of continuous "Data 0" is input, a "0 file" is automatically created and a "0 file" will be recorded in the disk as shown in schematic below.

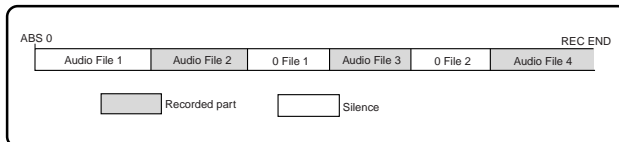

As explained in "Audio file and event" on page "29" in the "Before Starting" section of this manual, a "0 file" in the no sound section will always be counted as "1 event."

Consequently, if you create a lot of "0 file" during digital recording, it will cause event overflow on the disk.

To prevent such event overflow, the "Zero File?" menu can be used to setup so as not to generate "0 files." In the initial setting, it is set to "Enable" for generating "0 files" but by changing this to "Disable" "0 files" will not be generated, and "audio files" will then be recorded continuously.

- Initial setting: [Enable]
- Options: [Enable] or [Disable]
- \* This setting is shared by all Programs in the same disk.
- \* The setting cannot be saved and loaded as part of the song data.
- \* The settings are maintained after you turn off the power to the recorder.

- (1) While the recorder is stopped, press the [SETUP] key to enter SETUP mode.
- (2) Turn the Jog dial to select "Zero File ?" ("?" flashes), and then press the [EXECUTE/YES] key. The current setting will start flashing which indicates it is ready to change setting. In the case of initial setting it will show "Enable."

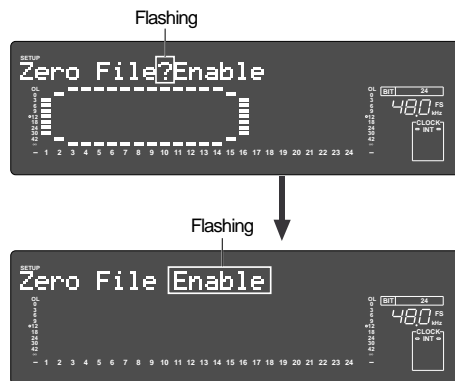

- (3) With the Jog dial, choose either "Enable" or "Disable" you want.

“Enable” (Initial setting)	0 files will be recorded.
“Disable”	0 files will not be recorded.

- (4) Press the [EXIT/NO] key or the [STOP] button repeatedly to exit SETUP mode.

To cancel the operation, or to restore the setting obtained prior to the [EXECUTE/YES] key press, press the [STOP] button or the [EXIT/NO] key. Each time you press one of these keys, the recorder returns to the previous hierarchy level of the menu, and finally exits SETUP mode and displays the previous Time Base.

### Converting the additional track format

A program created on the current drive formatted by the unit consists of 56 tracks (“V2 (56)” format): 24 real tracks plus 32 additional tracks for a 44.1kHz/48kHz FS program, or 8 real tracks plus 48 additional tracks for an 88.1kHz/96kHz FS program.

The “Converting the additional track format” menu allows to convert the total number of tracks (real track plus additional tracks) from 56 (“V2 (56)”) to 24 (“V1 (24)”) or vice versa.

This function gives compatibility to a hard disk, allowing you to use a hard disk with both “V2 (56)” format devices (D2424LV/D824mkII/D1624mkII) and “V1 (24)” format devices (D824/D1624).

When mounting a hard disk, converted from the “V2 (56)” format to the “V1 (24)” format, to the D824 or D1624 (a “V1 (24)” format device), the total number of real tracks plus additional tracks becomes 24.  
An 88.1kHz/96kHz FS program of the D1624 consists of 8 real tracks plus 16 additional tracks.

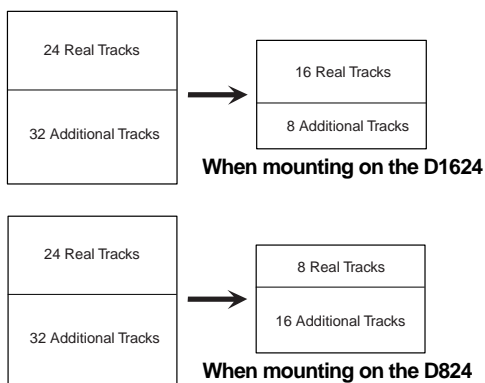

**<Note>**: When converting the format from “V2 (56)” to “V1 (24),” data on tracks 25 through 56 are deleted. Even if you convert such a program back to “V2 (56)” from “V1 (24),” the lost data for tracks 25 through 56 cannot be restored. When a converted hard disk is mounted on the D2424LVmkII, all 24 tracks on a 44.1kHz/48kHz FS program converted to “V1 (24)” are used as real tracks, therefore, no additional track exists.

- (1) While the recorder is stopped, press the [SETUP] key to enter SETUP mode.
- (2) Turn the Jog dial to select “Add.Trk Convert?” (“?” flashes), and then press the [EXECUTE/YES] key. The display will change to a warning message when the [EXECUTE/YES] key is pressed and the entire message will be repeated twice in a flowing movement. Upon ending display of the warning message, the display will change to the one for executing the conversion and “SURE?” will flash.



**<Warning Message>**:  
Caution! If This command is executed, all Multi. Undo & add. trk 25-56 data will be deleted.



<Display when converting V2 (56) to V1 (24)>

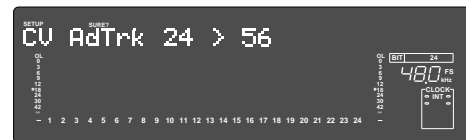

<Display when converting V1 (24) to V2 (56)>

Shown when a “V1 (24)” format hard disk is mounted.

- (3) Press the [EXECUTE/YES] key while pressing the [RECORD] button. Upon flashing converting, “COMPLETED!” will be lit.



- (4) Press the [EXIT/NO] key or [STOP] button. The display will change to the “Disk Optimize?” menu.

After converting by referring to page “34” “Optimizing the disk”, execute disk optimizing.

(Digital Recorder)

Model D2424LVmkII

**MIDI Implementation Chart**

Date:

Version: V1.00

Function.....		Transmitted	Recognized	Remarks
Basic Channel	Default	x	x	
	Changed	x	x	
Mode	Default	x	x	
	Message	x	x	
	Altered	*****	x	
Note Number:	True voice	x	x	
		*****	x	
Velocity	Note ON	x	x	
	Note OFF	x	x	
After Touch	Key's	x	x	
	Channel's	x	x	
Pitch Bend		x	x	
Control Change		x	x	
Program Change:	True #	x	x	
		*****	x	
System Exclusive		(rem. 1)	(rem. 2)	
Common	: Quarter frame			
	: Song Position		x	
	: Song Select	x	x	
	: Tune	x	x	
System Real Time	: Clock		x	
	: Commands	(rem. 3)	x	
Aux. Message	: Local ON/OFF	x	x	
	: All Notes OFF	x	x	
	: Active Sense	x	x	
	: Reset	x	x	
Notes		rem. 1: MMC (Device ID=00~99, 127), MTC, Identity reply, FOSTEX Exclusive rem. 2: MMC (Device ID=00~99, 127), MTC, Inquiry, FOSTEX Exclusive rem. 3: START, STOP, CONTINUE		

Mode 1: OMNI ON, POLY  
 Mode 3: OMNI OFF, POLY

Mode 2: OMNI ON, MONO  
 Mode 4: OMNI OFF, MONO

: Yes  
 x : No



## MMC Command List

Command List	Movement (Recorder)
01: STOP	STOP
02: PLAY	PLAY
03: DEFERRED PLAY	DEFERRED PLAY
04: FAST FORWARD	F FWD
05: REWIND	REWIND
06: RECORD STROBE	REC
07: RECORD EXIT	PUNCH OUT
09: PAUSE	STOP
40: WRITE	Refer to MMC Response/Information Field List
41: MASKED WRITE	Refer to MMC Response/Information Field List
42: READ	Refer to MMC Response/Information Field List
44: LOCATE	LOCATE to Setting Data
46: SEARCH	CUE/REVIEW (+/- 1~60 times)
47: SHUTTLE	CUE/REVIEW (+/- 1~60 times)
4C: MOVE	Refer to MMC Response/Information Field List
4D: ADD	Refer to MMC Response/Information Field List
4E: SUBTRACT	Refer to MMC Response/Information Field List

MMC Response/Information Field List	Command
01: SELECTED TIME CODE	READ/WRITE/MOVE/ADD/SUBTRACT
03: REQUESTED OFFSET	READ/WRITE
04: ACTUAL OFFSET	READ
08: GP 0	READ/WRITE/MOVE/ADD/SUBTRACT
09: GP 1	READ/WRITE/MOVE/ADD/SUBTRACT
0A: GP 2	READ/WRITE/MOVE/ADD/SUBTRACT
0B: GP 3	READ/WRITE/MOVE/ADD/SUBTRACT
0C: GP 4	READ/WRITE/MOVE/ADD/SUBTRACT
0D: GP 5	READ/WRITE/MOVE/ADD/SUBTRACT
0E: GP 6	READ/WRITE/MOVE/ADD/SUBTRACT
0F: GP 7	READ/WRITE/MOVE/ADD/SUBTRACT
48: MOTION CONTROL TALLY	READ
4C: RECORD MODE	READ/WRITE
4E: TRACK RECORD STATUS	READ
4F: TRACK RECORD READY	READ/WRITE/MASKED WRITE
51: RECORD MONITOR	READ/WRITE

## Inquiry Message List

IDENTITY REQUEST: F0, 7E, <channel>, 06, 01, F7  
 IDENTITY REPLY: F0, 7E, <channel>, 06, 02, 51, 01, 00, 12, 00, 01, 00, 7F, 7F, F7

51: Fostex ID  
 01, 00: Device family code  
 12, 00: Device family number D2424LVmkII  
 01, 00, 7F, 7F: Software version

## Fostex MIDI System Exclusive Message Format for D2424LVmkII

**<Note>**

Following protocol is effective only in equipment which will reply by -  
 Identity Reply=F0 7E<channel>06 02 51 01 00 12 00 01 00 7F \*7F F7  
 against the Inquiry Message=F0 7E<channel>06 01.

### Fostex System Exclusive Message

General Structure=F0 51<device id><sub id 1>(<data>)F7

\* Numbers are all expressed in hexadecimal units.

Table: <sub id 1> (<data>)

Command or Model Set Controller to D2424LVmkII		Acknowledge or Status D2424LVmkII to Controller
Loop on/off	12 22 (<on/off>)	
Post locate	12 28 (<post locate mode>)	
Auto rec	12 2D (<on/off>)	32 2D (<edit message>)
Lock enable	12 41 (<lock enable>)	
Lock mode	12 42 (<lock mode>)	
Copy clip	12 45 (<count><mmc track>)	32 45 (<edit message>)
Copy paste	12 46 (<count=01><repeat count>)	32 46 (<edit message>)
	or 12 46 (<count><repeat count><mmc track>)	
Erase	12 47 (<count><mmc track>)	32 47 (<edit message>)
Clipboard play	12 49	32 49 (<edit message><mmc track>)
Undo	12 4A	32 4A (<edit message>)
Redo	12 4B	32 4B (<edit message>)
Move clip	12 4D (<count><mmc track>)	32 4D (<edit message>)
Move paste	12 4E (<count=01><repeat count>)	32 4E (<edit message>)
	or 12 4E (<count><repeat count><mmc track>)	
Track Exchange	12 4F (<channel><channel>)	32 4F (<edit message>)
New program	13 3E	33 3E (<edit message>)
Delete program	13 3F	33 3F (<edit message>)
Digital in ch.	13 41 (<channel><channel><sync/async>)	
Adat in	13 41 (<channel=7f><count=0><sync/async>)	
Digital out ch.	13 42 (<channel><channel>) * Refer to Note.	
Adat out	13 42 (<channel=7f><channel=0>)Adat out	
Program change	13 43 (<program>)	
Click on/off	13 44 (<on/off>)	
Resolution on/off	13 46 (<on/off>)	
Midi Sync out	13 47 (<nidi sync>)	
MTC offset mode	13 48 (<MTC offset mode>)	
Vari pitch	13 49 (<count=3><on/off><vari pitch>)	
	or 13 49 (<count=1><on/off>)	
Signature set	14 01 (<signature map>)	34 00 (<edit message>)
Tempo set	14 02 (<tempo set map>)	34 00 (<edit message>)
Tempo map all erase	14 03	34 00 (<edit message>)
Preroll time set	14 04 (<mmc time>)	
Frame rate set	14 06 (<frame rate>)	
Fs rate set	14 07 (<FS rate>)	
Time base set	14 08 (<time base>)	
Date time set	14 09 (<date><mmc time>)	
Auto level out md.	14 0A (<on/off>)	

## Status Request

Status request command Controller to D2424LVmkII	Status reply D2424LVmkII to controller
Loop op. status 22 21	32 21 (<Loop op. mode = 12>)
Loop status 22 22	32 22 (<on/off>)
Post locate status 22 28	32 28 (<post locate status>)
Auto rec status 22 2D	32 2D (<edit message>)
Lock status 22 41	32 41 (<lock status>)
Lock mode status 22 42	32 42 (<lock mode>)
Copy clip status 22 45	32 45 (<edit message=01 or =14>)
Copy paste status 22 46	32 46 (<edit message=02><mmc time>) or 32 46 (<edit message=00>)
Erase status 22 47	32 47 (<edit message=02><mmc time>) or 32 47 (edit message=00>)
Move clip status 22 4D	32 4D (<edit message=01 or =14>)
Move paste status 22 4E	32 4E (<edit message=02><mmc time>) or 32 4E (<edit message=00>)
Digital in ch. st. 23 41	33 41 (<channel><channel>)
Adat in status 23 41	33 41 (<channel=7F><count><mmc track>)
Digital out ch. st. 23 42	33 42 (<channel><channel>)
Adat out status 23 42	33 42 (<channel=7F><channel=0>)
Program status 23 43	33 43 (<program>)
Click status 23 44	33 44 (<on/off>)
Level status 23 45	33 45 (<count=10><level data>)
Resolution status 23 46	33 46 (<on/off>)
Midi sync out status 23 47	33 47 (<midi sync>)
MTC offset mode status 23 48	33 48 (<MTC offset mode>)
Vari pitch status 23 49	33 49 (<count=3><on/off><vari pitch>)
Signature map 24 01(<event number>)	34 01 (<signature map>)
Tempo set map 24 02(<event number>)	34 02 (<tempo set map>)
Preroll time 24 04	34 04 (<mmc time>)
Remain time 24 05	34 05 (<mmc time>)
Frame rate status 24 06	34 06 (<frame rate>)
Fs rate status 24 07	34 07 (<Fs rate>)
Time base status 24 08	34 08 (<time base>)

### <Note>

There is a limitation on specifying the <channel><channel> setting. For details, refer to "Explanation on Command/Mode Set" mentioned in later pages.

**<Allocation of GP0~GP7>**

Edit point memory of this equipment is allotted to the response/information field of 08~0F (GP0~GP7) as shown below.

GP7 however, will be used as the work memory for small adjusting of the registered figure (Refer to Examples 4 and 5).

<Response/Information Field>

08 GP0 : locate memory	09 GP1 : clipboard in memory
0A GP2 : clipboard out memory	0B GP3 : start memory
0C GP4 : auto punch in memory	0D GP5 : auto punch out memory
0E GP6 : end memory	0F GP7 : reserved

**[Example 1] <mmc time> is registered in the start memory (using the write command).**

F0 7F <device ID> 06 <write = 40> <count> <GP3 = 0B> <mmc time> F7

**[Example 2] Locate memory is recalled (using the read command).**

F0 7F <device ID> 06 <read = 42> <count> <GP3 = 0B> <mmc time> F7

**[Example 3] On-the-fly registering in the punch in memory (using the move command).**

F0 7F <device ID> 06 <move = 4C> <count> <destination = 0C (GP4) > <source = selected time code = 01> F7

**[Example 4] When + 1 frame is to be set in the punch in memory (using the add command).**

\* Time figure to be added is pre-registered in GP7 (Set 00h 00m 00s 01f in GP7).

F0 7F <device ID> 06 <add = 4D> <count> <destination = 0C (GP4)> <source #1 = 01 (GP4)> <source #2 = 0F (GP7)> F7

**[Example 5] When -1 frame is to be set in the punch in memory (using the subtract command).**

\* Time figure to be subtracted is pre-registered in GP7 (Set 00h 00m 00s 01f in GP7).

F0 7F <device ID> 06 <subtract = 4E> <count> <destination = 0C (GP4)> <source#1 = 0C (GP4)> <source #2 = 0F (GP7)>F7

## Data Type

<loop op.mode>	12=stop Indicates the next operating mode following locating to the start point (GP3) upon arriving at the end point (GP6) by the play mode. In D2424LVmkII, 12=stop only is effective.
<post locate mode>	12=stop 15=play Specifies operating mode in which D2424LVmkII should enter upon completing the locate operation. Corresponds to the setting of AUTO PLAY ON ("15")/OFF ("12") on the main unit.
<count>	01 ~ 7F Specifies succeeding data byte numbers.
<mmc track>	Complies to the MMC (MIDI MACHINE CONTROL) standard track bit map. In D2424LVmkII, you always need to specify two byte combinations of "r0" and "r1."
<edit message>	00 = no message 01 = completed (completion flag) 02 = active (execution flag) 02<mmc time> = Indicates unprocessed time by active (execution flag) and <mmc time>. 02<count><mmc track> = Indicates source track by active (execution flag) and <mmc track>. Used for clipboard play. 03 = cancel (execution stop) 05 = Indicates rehearsal (rehearsal mode of auto rec). Possible of undo. 06 = Indicates take (take mode of auto rec). Possible of undo. 10 = over value error 10 <mmc time> = Capacity shortage time is indicated by over value error (error by capacity shortage) and <mmc time>. In copy paste, it indicates capacity shortage time required for a minimum one time paste. 11 = Indicates in point error (incorrect in point). 12 = Indicates out point error (incorrect out point). 14 = Indicates void data (data necessary for paste does not exist). 18 = Indicates track select error (track necessary to execute copy/move or erase/cut is not correctly setup). 19<repeat count> = Indicates repeat number error and repeat numbers executable by <repeat count>. 1A = Indicates disable rec (record disable mode). 25 = Indicates can't undo rehearsal (rehearsal mode of auto rec). Impossible to undo. 26 = Indicates can't undo take (take mode of auto rec). Impossible to undo. 71 = Indicates on. 72 = Indicates off.
<mmc time>	hr mn sc fr {ff/st} complies to the MMC standard time code.
<on/off>	70 = default 71 = on 72 = off
<repeat count>	01 ~ 7F Especially when executing commands such as paste, the number of pasting times to be continuously repeated following the auto punch in point is specified.
<channel>	00 ~ 56, 7F Select recorder tracks 1~56. "00" in particular, is not specified (default setting). "7F" indicates input/output of Adat optical. For details, refer to explanation on setting the Command/Mode.
<lock enable>	00 = lock disable, chase disable 01 = lock enable, chase enable Corresponds to SLAVE ON ("01")/OFF ("00") in the main unit.
<lock status>	00 = lock disable, chase disable 01 = lock enable (unlocked), chase enable (unlocked) 11 = lock enable (locked), chase enable (locked)
<program>	01 ~ 7F Indicates program numbers (P1 ~ P99) on the main unit. However, D2424LVmkII can specify only 01 (corresponds to P01) ~ 63H (corresponds to P99).
<lock mode>	40 = Free 42 = Vari Indicates the slave mode when this equipment is set to slave ON.

<b>&lt;signature map&gt;</b>	<p>bar2, bar1, bar0, sign, sigd                      bar2: The 100th digit of the bar figure is expressed in BCD.                      bar1: The 10th digit of the bar figure is expressed in BCD.                      bar0: The 1 digit of the bar figure is expressed in BCD.                      sign: Numerator of the signature to be set is expressed in BCD.                      sigd: Denominator of the signature to be set is expressed in BCD.                      When specified as sign=00 and sigd=00, signature data of that bar position will be deleted. Also, bar2=bar1=bar0=sign=sigd=00 indicates "no corresponding data" (such as when a figure specified by &lt;event number&gt; do not exist at receiving the signature map request).</p>
<b>&lt;tempo set map&gt;</b>	<p>bar2, bar1, bar0, beat, tmp2, tmp1, tmp0                      bar2: The 100th digit of the bar figure is expressed in BCD.                      bar1: The 10th digit of the bar figure is expressed in BCD.                      bar0: The 1 digit of the bar figure is expressed in BCD.                      beat: The beat figure is expressed in BCD.                      tmp2: Numerator of the tempo to be set is expressed in BCD.                      tmp1: Denominator of the tempo to be set is expressed in BCD.                      tmp0: The 1 digit of the tempo is expressed in BCD.                      When specified as tmp2=tmp1=tmp0=00, tempo data of that bar and meter position will be deleted. Also, bar2=bar1=bar0=sign=sigd=00 indicates "no corresponding data" (such as when a figure specified by &lt;event number&gt; do not exist at receiving the signature map request).</p>
<b>&lt;event number&gt;</b>	<p>When one data registered by &lt;signature map&gt; and &lt;tempo set map&gt; is declared as one event, the number of events from head of the tune (the umpteenth event counted from head of the tune) must be specified. &lt;event number="00"&gt; is the first event.</p>
<b>&lt;midi sync&gt;</b>	<p>00: OFF                      01: CLK (MIDI CLOCK)                      02: MTC                      This corresponds to "MIDI SYNC OUT" of the SETUP menu.</p>
<b>&lt;vari pitch&gt;</b>	<p>Will be composed of two bytes (Q, P).                      Q: 0qqqqqqq (binary) -&gt; &lt;vari data&gt; = "qqqqqqpppppp" A 14 bit data of X0.1                      P: 0qqqqqqq (binary) attached with a minus symbol.                      Vari-pitch must be specified, at +0.1% when MSB (q)=0 (Example: 0000000000001), and at -0.1% when MSB (q)=1 (Example: 1111111111111).</p>
<b>&lt;frame rate&gt;</b>	<p>00: 30nd                      01: 29.97nd                      02: 29.97df                      03: 25                      04: 24                      05: 30df                      Corresponds to selecting "FRAME RATE" of the SETUP menu.</p>
<b>&lt;MTC offset mode&gt;</b>	<p>00: ABS                      01: signature                      Corresponds to selecting "MTC OFFSET MODE" of the SETUP menu.</p>
<b>&lt;time base&gt;</b>	<p>00: ABS                      01: BAR BEAT                      02: MTC                      Corresponds to selecting "TIME BASE SEL" of the SETUP menu.</p>
<b>&lt;level data&gt;</b>	<p>t1, t2 ..... tn                      n: Indicates the track number.                      tn: Indicates absolute 8 bits of the Audio 16 bit data (Range: 00 ~ 7F).</p>

## Explanation on the Command/Mode Set

### 12 22 (<on/off>): loop on/off command

The command for setting the "loop mode on/off" (=ON/OFF of AUTO RTN) of the D2424LVmkII.  
Default figure of the loop operation mode is "12=stop" and this cannot be changed.

### 12 28 (<post locate mode>): post locate command

The command for setting the "post locate mode" (=ON/OFF of AUTO PLAY) of the D2424LVmkII.  
It will stop after locating if "post locate mode=12."  
It will enter play after locating if "post locate mode=15."

### 12 2D (<on/off>): auto rec command

The command for setting "auto rec mode on/off" (=ON/OFF of AUTO PUNCH) of the D2424LVmkII.  
Upon receiving this command, the D2424LVmkII will immediately reply the operating condition by sending "32 2D (<edit message>)".

### 12 41 (<lock enable>): lock enable command

The command for setting "slave mode on/off" (setup menu) of the D2424LVmkII.

### 12 42 (<lock mode>): lock mode command

The command for setup of the slave mode (setup menu) when this equipment is set to "slave mode on."

### 12 45 (<count><mmc track>) : copy clip command

When this command is received, the D2424LVmkII will copy (multiple number of tracks can be copied simultaneously) the sound data, as data for copy paste, from the pre-registered clipboard-in point to the clipboard-out point in the track specified by <mmc track>.  
With completion of copying the data into the clipboard, the D2424LVmkII will immediately reply with "32 45 (<edit message=01 (completed)>)".  
If copy cannot be executed due to improper figures of the pre-registered clipboard in/clipboard out points or incorrect track section, the corresponding <edit message> will be returned.

### 12 46 (<count=01><repeat count>): copy paste command

### 12 46 (<count><repeat count><mmc track>): copy paste command

When this command is received, the D2424LVmkII will paste the sound data which has been copied into the clipboard, on the same track from the pre-registered auto punch in point as the starting point for the number of time specified by <repeat count>.  
However, if the sound data length in the clipboard is less than 10ms, the specifying the <repeat count> will be limited to "01." Also, by specifying <mmc track>, paste can be executed on other tracks in mono (in one track units) or stereo units (in combinations of tracks 1-2, 3-4, 5-6, 7-8.....).  
Since time corresponding to length of the copy clipped sound data is required to complete the copy paste operation, the D2424LVmkII immediately replies with "32 46 (<edit message=02 (active)>)" after receiving the command.  
Successively upon completing the paste operation, "32 46 (<edit message=01 (completed)>)" is transmitted.  
If paste cannot be executed due to improper figures of the pre-registered auto punch in point, insufficient disc capacity, no sound data in the clipboard, etc., the corresponding <edit message> will be replied.

### 12 47 (<count><mmc track>): erase command

When this command is received, the D2424LVmkII will erase the data (writes in "0" data) in the section from the pre-registered auto punch in point through auto punch out point in the track specified by <mmc track>.  
Since time corresponding to length of the erase section is required to complete the erase operation, the D2424LVmkII will immediately reply by "32 47 (<edit message=02 (active) >)" after receiving the command.  
After the completion of erase operation, "32 47 (<edit message=01 (completed) >)" will be transmitted.  
If erase cannot be executed due to improper figures of the pre-registered auto punch in point/auto punch out point, incorrect track section, etc., the corresponding <edit message> will be replied.

### 12 49: clipboard play command

When this command is received, the D2424LVmkII will playback once from the head of the sound data copied in the clipboard by the copy clip and move clip commands. Immediately after receiving the command, the D2424LVmkII will reply with "32 49 (<edit message=02 (active)><count><mmc track>)." The sound data track number is indicated by (mmc track).  
Upon completion of playback, "32 49 (<edit message=01 (completed) is sent and clipboard play is ended.  
If there is no sound data in the clipboard, "32 49 (<edit message=14 (void data)>)" will be sent and clipboard play operation will be interrupted.

### 12 4A: undo command

Upon receiving this command, the D2424LVmkII will revert to the condition prior to editing copy paste,erase, move paste, cut, redo operation.  
With completion of undo operation, D2424LVmkII will reply with "32 4A (<edit message=01 (completed)>)." If the D2424LVmkII is not possible to undo, "32 4A (<edit message=00 (no message)>)" will be replied.

### 12 4B: redo command

When this command is received, the D2424LVmkII will return to the condition prior to undo operation.  
With completion of redo operation, D2424LVmkII will reply with "32 4B (<edit message=01 (completed)>)." If the D2424LVmkII is not possible to redo, "32 4B (<edit message=00 (no message)>)" will be replied.

### 12 4D (<count><mmc track>): move clip command

When this command is received, the D2424LVmkII will copy (multiple tracks can be copied simultaneously) the sound data from the pre-registered clipboard in point to the clipboard out point, as data for move paste operation.  
With completion copying the data into the clipboard, the D2424LVmkII will immediately reply with "32 4D (<edit message=01 (completed)>)." If copy cannot be executed by the reason of pre-registered improper clipboard in/clipboard out point figures or incorrect track section, etc., the corresponding <edit message> will be replied.

### 12 4E (<count=01><repeat count>): move paste command

### 12 4E (<count><repeat count><mmc track>): move paste command

When this command is received, the D2424LVmkII will paste the sound data which have been move clipped in the clipboard, for the number of times specified by <repeat count> on the same track from the pre-registered auto punch in point as the starting point.  
At the same time, the move clipped original sound data will be erased (data "0" is written in). However, when sound

data length in the clipboard is less than 10ms, specifying the <repeat count> will be limited to "01."

Also, by specifying the <mmc track>, paste operation can be executed on other tracks in mono (one track unit) or stereo units (tracks 1-2, 3-4, 5-6, 7-8....).

Since time corresponding to length of the move clipped sound data is required to complete the move paste operation, D2424LVmkII will immediately reply with "32 4E (<edit message=02 (active)>)" after receiving the command.

Following completion of the move paste operation, "32 4E (<edit message = 01 (completed)>)" will be sent.

If paste cannot be executed due to improper figures of the previously registered auto punch in point, insufficient disc capacity, no sound data is in the clipboard, etc., the corresponding <edit message> will be replied.

#### 12 4F (<channel><channel>): track exchange command

When the D2424LVmkII receives this command, the track can be exchange between the specified <channel> <channel>. Especially, if the first <channel=00><channel=01>, then exchange by grouping will be executed between channel 1-8 and channel 17-24, and if the next byte <channel=00> <channel=02>, then the exchange will be between channel 9-16 and channel 17-24. If it cannot be executed for some reason, an error message will be sent back.

#### 13 3E: product new program command

When the D2424LVmkII receives this command, a new program is compiled and the current program is transferred to the new program. As compilation of the new program is comparatively short time, it is replied with "33 3E (<edit message=01 (completed)>)" immediately upon completion of execution.

If it cannot be executed for some reason, an error message will be sent back.

#### 13 3F: delete current program command

When the D2424LVmkII receives this command, the current program is deleted and succeeding programs moved up and renumbered. If the deleted program is the only tune existing in the track, a new program will be made automatically.

As this delete current program is executed in a comparatively short time, "33 3F (<edit message=01 (completed)>)" will be sent back immediately upon completing the execution.

If it cannot be executed for some reason, an error message will be sent back.

#### 13 41 (<channel><channel>): digital in ch.select command

The audio signal input from SPDIF digital in to assigned to the destination track specified by <channel>.

The first <channel> shown in the command is the SPDIF L channel input, and the second <channel> the R channel input. "<channel=0> <channel =0>" indicates the normal analog input. In the D2424LVmkII, channels 1 and 2 only can be selected for other than <channel=0>.

#### 13 41 (<channel=7F><count><mmc track>): Adat in select command

Channel = 7F indicates that it is Adat In. Normally, it will be "<count=0>" and all channels will be inputs from Adat In.

If <count=0><mmc track> is indicates, then only the tracks selected will be Adat In inputs. "<channel=0><channel=0>" indicates the normal analog input.

#### 13 42 (<channel><channel>): digital out ch.select command

The source channel for digital out is selected.

Normally, the first <channel> shown will be the SPDIF L channel data, and the second <channel> the SPDIF R channel output. (<00> <00>) is the default setting. By FDMS-3 V3.0, any channel within "1 ~ 8" (or 9 ~ 16 or 17 ~ 24) can be selected.

#### 13 42 (<channel=7F><channel=0>): Adat out select command

In a device which can be switched between SPDIF and Adat, if the first display is <channel=7F>, then Adat Out can be setup.

#### 13 43 (<program>): program change command

The command for PROGRAM CHANGE of the D2424LVmkII. The present program number can be changed to the figure indicated by <program>.

#### 13 44 (<on/off>): click on/off command

The command for setting the metronome on/off of the D2424LVmkII. When ON is set, the metronome signal will be fed to the track 24 output of the D2424LVmkII.

#### 13 46 (<on/off>): Bar/Beat Resolution ON/OFF command

The command for ON/OFF of the bar/beat resolution function of this equipments' current program.

#### 13 47 (<midi sync>): Midi Sync Out command

The setup command for MIDI Sync Out mode of this equipments' current program.

#### 13 48 (<MTC offset mode>): MTC offset mode command

The setup command for MTC offset mode of this equipment's current program.

#### 13 49 (<count=3> <on/off> <vari data>): Vari pitch command

#### 13 49 (<count=1> <on/off>): Vari pitch command

The command for setting this equipments' vari pitch ON/OFF and pitch data.

Control of ON/OFF only is possible at <count=1> and both ON/OFF and pitch data can be set at <count=3>.

#### 14 01 (<signature map>): Signature set command

The command for setting the meter of this equipment.

If a new data is registered at the bar position where a data exists, the former data will be written over.

When this command is received, this equipment will reply with "34 01 (<edit message>)."

Upon completing the registration, <edit message> will reply with "01 (completed)," or with "10 (over value error)" if registration is attempted at a non-existing point or an erroneous figure is used.

#### 14 02 (<tempo set map>): Tempo set command

The command for tempo set of this equipment.

If a new data is registered in a bar/meter where data already exists, the former data will be written over.

When this command is received, this equipment will reply with "34 02 (<edit message>)."

Upon completing the registration, <edit message> will reply with "01 (completed)," or with "10 (over value error)" if registration is attempted at a non-existing point or an erroneous figure is used.

#### 14 03 : Tempo map all erase command

When this command is received, this equipment will erase all meter and tempo data in the current program and thus return it to the default state (meter=4/4, tempo=120). Also, when this command is received, this equipment will reply with "34 03 (<edit message>)."



Upon completing the registration, <edit message> will reply with "01 (completed)," or with "10 (over value error)" if registration is attempted at a non-existing point or an erroneous figure is used.

**14 04 (<mmc time>): Preroll time set command**

The command for setting the current program preroll time at the figure indicated by <mmc time>.

**14 06 (<frame rate>): Frame rate set command**

The command for setting the current program frame rate at the figure indicated by <frame rate>.

**14 08 (<time base>): Time base set command**

The command for setting the current program time base of this equipment to that indicated by <time base>.

## The Status Request Command

**22 21: loop operation status request**

The command inquiring the loop operation mode setup status. The D2424LVmkII will reply with "32 21 (<loop op.mode=12>)."

**22 22: loop on/off status request**

The command inquiring the loop on/off (=ON/OFF of AUTO RETURN) setup status. The D2424LVmkII will reply with "32 22 (<on/off>)."

**22 28: post locate status request**

The command inquiring the post locate mode (ON/OFF of AUTO PLAY) setup status. The D2424LVmkII will reply with "32 28 (<post locate mode>)."

**22 2D: auto rec status request**

The command inquiring the auto rec mode setup status and this is replied by "32 2D (<edit message>)."  
Reply from the D2424LVmkII against this status request will be either one of the following:

<edit message> =05: Possible to undo rehearsal mode.  
=06: Possible to undo take mode.  
=72: off

**22 41: lock status request**

The command inquiring the slave on/off setup status and the lock status. The D2424LVmkII will reply with "32 41 (<lock status>)."

**22 42 : lock mode status request**

The command for inquiring the lock mode setup status and this is replied with "32 42 <lock mode>."

**22 45: copy clip status request**

The command inquiring the clipboard condition. If there is a copy paste data in the clipboard, the D2424LVmkII will reply with "32 45 (<edit message=01>)."  
If data in the clipboard is for move paste or there is no valid data in it, it will reply will "32 45 (<edit message=14 (void data)>)."

**22 46: copy paste status request**

The command inquiring execution status of copy paste editing. When this command is received, the D2424LVmkII will reply with either "32 46 (<edit message=02><mmc time>)" or "32 46 (<edit message=00>)." <mmc time> indicates unprocessed time until completion.

**22 47: erase status request**

The command inquiring execution status of erase. When this command is received, the D2424LVmkII will reply by either "32 47 (<edit message=02><mmc time>)" or "32 47 (<edit message=00>)." <mmc time> indicates unprocessed time until completion.

**22 4D: move clip status request**

The command inquiring the clipboard status. If there is a move paste data on the clipboard, the D2424LVmkII will reply with "32 4D (<edit message=01>)."  
If data in the clipboard is for copy paste or there is no valid data on it, "32 4D (<edit message=14 (void data)>)" will be replied.

**22 4E: move paste status request**

The command inquiring the move paste execution status. When this command is received, the D2424LVmkII will reply with "32 4E (<edit message=02><mmc time>)" or "32 4E (<edit message=00>)." <mmc time> indicates unprocessed time until completion.

**23 41: digital in channel status request**

**23 41: adat in channel status request**

The command inquiring the digital in channel setup status.

When this command is received, the D2424LVmkII will reply with "33 41 (<channel> <channel>)" or "33 41 (<channel=7F> <count> <mmc track>)."

**23 42: digital out channel status request**

**23 42: adat out channel status request**

The inquiring the digital out channel setup status. When this command is received, the D2424LVmkII will reply with "33 42 (<channel><channel>)" or "33 42 (<channel=7F><channel=0>)."

**23 43: program status request**

The command inquiring the presently operating program number. When this command is received, the D2424LVmkII will reply with "33 43 (<program>)."

**23 44: click on/off status request**

The command inquiring the metronome on/off status of the D2424LVmkII. When this command is received, the D2424LVmkII will reply with "33 44 (<on/off>)."

**23 45: level status request**

The command inquiring the present output level data of the 1~24 tracks. In the D2424LVmkII as the level data is updated about every 40msec., inquiry in 40msec. units is effective. When this command is received, the D2424LVmkII will reply with "33 45 (<count=10><level data>)."

**23 46: resolution status request**

The command for inquiring the resolution on/off setup status. When this command is received, this equipment replies with "33 46 <on/off>."

**23 47: midi sync out status request**

The command for inquiring on status of the midi sync out setup condition. When this command is received, this equipment replies with "33 47 <midi sync>."

**23 48: MTC offset mode status request**

The command for inquiring the MTC offset mode setup status. When this command is received, this equipment replies with "33 48 <MTC offset mode>."

**23 49: vari pitch status request**

The command for inquiring status of vari pitch on/off and vari pitch data. When this command is received, this equipment replies with "33 49 (<count=3><on/off><vari data>)."

**24 01 (<event number>): signature map request**

The command for inquiring the meter setup. Order number counting from the leading tune must be specified in the event number (The first event is expressed as "event number=00." When this command is received, this equipment replies with "34 01 (<signature map>)."

**24 02 (<event number>): Tempo set map request**

The command for inquiring tempo data. Order number from the leading tune must be specified in the event number (The first event is expressed as "event number=00." When this command is received, this equipment replies with "34 02 (<tempo set map>)."

**24 04: preroll time status request**

The command for inquiring the preroll time setup status. When this command is received, this equipment replies with "34 04 (<mmc time>)."

**24 05: remain time request**

The command for inquiring the disk remaining time which is recordable. When this command is received, this equipment replies with "34 05 (<mmc time>)."

**24 06: frame rate status request**

The command for inquiring the frame rate setup status. When this command is received, this equipment replies with "34 06 (<frame rate>)."

**24 08: time base status**

The command for inquiring the setup status of the time base shown in the display. When this command is received, this equipment replies with "34 08 (<time base>)."

**Explanation on the Status Reply**

**32 21 (<loop op.mode>): loop operation mode status reply**

This is the reply against the "22 21" loop operation status request command. <loop op.mode=12> is the only status data of D2424LVmkII and any other setting is not permissible.

**32 22 (<on/off>): loop on/off status reply**

This is the reply against "22 22" loop on/off status request.

**32 28 (<post locate mode>): post locate mode status reply**

This is the reply against "22 28" post locate status request. <post locate mode=12 or 15> is the only status data of D2424LVmkII and any other setting is not permissible.

**32 2D (<edit message>): auto rec status reply**

This is the reply against the "12 2D" auto rec command or the "22 2D" auto rec status request.

**32 41 (<lock status>): lock status reply**

This is the reply against the "22 41" lock status request.

**32 42 (<lock mode>): lock mode status reply**

This is the reply against the "22 42" lock mode status request.

**32 45 (<edit message>): copy clip status reply**

This is the reply against the "12 45" copy clip command or the "22 45" copy clip status request.

**32 46 (<edit message>): copy paste status reply**

**32 46 (<edit message><mmc time>): copy paste status reply**

This is the reply against the "12 46" copy paste command or the "22 46" copy paste status request. <mmc time> indicates the unprocessed time until completion of copy paste editing.

**32 47 (<edit message>): erase status reply**

**32 47 (<edit message><mmc time>): erase status reply**

This is the reply against "12 47" erase command or "22 47" erase status request.

**32 49 (<edit message><count><mmc track>): clipboard play status reply**

This is the reply against the "12 49" clipboard play command. If there is no sound data in the clipboard, "32 49"(<edit message=14 (void data)>)" will be replied. <mmc track> indicates the sound data track number.

**32 4A (<edit message>): undo status reply**

This is the reply against the "12 4A" undo command. Either <edit message=01 (completed) or <edit message=14 (void data)> will be replied.

**32 4B (<edit message>): redo status reply**

This is the reply against the "12 4B" redo command. Either <edit message=01 (completed)> or <edit message=14 (void data)> will be replied.

**32 4D (<edit message>): move clip status reply**

This is the reply against the "12 4D" move clip command or "22 4D" move clip status request.

**32 4E (<edit message>): move paste status reply**

**32 4E (<edit message><mmc time>): move paste status reply**

The reply against the "12 4E" move paste command or the "22 4E" move paste status request. <mmc time> indicates the unprocessed time until completion of move paste editing.

**32 4F (<edit message>): track exchange status reply**

This is the reply against the "12 4F" track exchange command.

**33 3E (<edit message>): product new program status reply**

This is the reply against the "13 3E" product new program command.

**33 41 (<channel><channel>): digital in channel status reply**

**33 41 (<channel=7F><count><mmc track>): adat in status reply**

This is the reply against the "23 41" digital in ch. st. request. The first <channel> indicates the track number assigned to the L channel of the digital audio signal (S/P DIF) from the DATA IN connector, and the second <channel> the track number assigned to the R channel. If digital in is set to "Adat," the reply for the first <channel> will be 7F and then <count> <mmc track>, in this order. In the <mmc track>, the track bit map which is the Adat input, is expressed by "1" (In this equipment, the track actually locked is expressed as "1").

**33 42 (<channel><channel>): digital out channel status reply**

**33 42 (<channel=7F><channel=00>): adat out status reply**

This is the reply against the "23 42" digital out ch. st. request.

The first <channel> indicates the track number assigned to the L channel output of the digital audio signal (S/P DIF) from the DATA OUT connector, and the second <channel> the track number as signed to the R channel output.

If digital out is set to "Adat," the reply for the first <channel> will be 7F and that for the second <channel> will be 00.

**33 43 (<program>): program status reply**

This is the reply against the "23 43" program status request.

<program> indicates the presently operating program number.

**33 44 (<on/off>): click status reply**

This is the reply against the "23 44" click status request. It indicates the on/off setting of the metronome function.

**33 45 (<count=10><level data>): level status reply**

This is the reply against the "23 45" level status request and it indicates the present track 1-24 output level data. In the D2424LVmkII, as level data is updated 40msec., it will be effective if inquiry is made in 40msec. units.

**33 46 (<on/off>): bar/beat resolution status reply**

This is the reply against "23 46" bar/beat resolution status request.

**33 47 (<midi sync>): midi sync out status reply**

This is the reply against "23 47" midi sync out status request.

**33 48 (<MTC offset mode>): MTC offset mode status reply**

This is the reply against "23 48" MTC offset mode status request.

**33 49 (<count=3><on/off><vari data>): vari pitch status reply**

This is the reply against "23 49" vari pitch status request and is indicating the vari pitch function on/off and the present vari pitch setup figure.

**34 01 (<signature map>): signature map status reply**

This is the reply against "24 01" (<event number>) signature map request. The signature map of the event indicated by the <event number> is replied.

If there is no event specified (Example: Such as when <event number=5> is requested even though there is only 5 meters registered), it will be replied with all figures at 00 of the <signature map>.

**34 02 (<tempo set map>): tempo set map status reply**

The reply against "24 02"(<event number>)tempo set map request. Tempo set map of the event indicated by the <event number> is replied.

If there is no event specified (Example: Such as when <event number=20> is requested although only 10 is setup for tempo), it will be replied with all figures at 00 of the <signature map>.

**34 04 (<mmc time>): preroll set map status reply**

This is the reply against "34 04" preroll time status request and this is replied with the presently set preroll time.

**34 05 (<mmc time>): remain time reply**

This is the reply against "24 05" remain time request, and is replied with the recordable disc remaining time.

**34 06 (<frame rate>): frame rate status reply**

This is the reply against "24 06" frame rate status request, and is replied with the presently set frame rate.

**34 07 (<fs rate>): fs rate status reply**

This is the reply against "24 07" fs rate status request, and is replied with the presently set fs (sampling frequency).

**34 08 (<time base>): time base status reply**

This is the reply against "24 08" time base status request, and is replied with the presently set time base (in the display).

## Maintenance

### Cleaning the exterior

\* For normal cleaning, use a soft dry cloth.

For stubborn dirt, moisten a cloth in diluted detergent, wring it out firmly, and wipe the dirt off. Then polish with a dry cloth. Never use solvents such as alcohol, thinner or benzene, since these will damage the printing and finish of the exterior.

## Specifications

### Recorder Section

Recording Medium	: 3.5 inch, E-IDE type hard disk
Recording Format	: FDMS3 version 3
Save/Load Format	: FDIO-1 version 2
Sampling Frequency	: 44.1kHz, 48kHz, 88.2kHz, 96kHz
Quantization	: 16bit / 24bit linear, 24bit (at 88.2/96kHz)
A/D Converter	: 24bit Delta Sigma 128 times over sampling
D/A Converter	: 24bit Delta Sigma 128 times over sampling
Recording Tracks	: 24 real tracks + 32 additional tracks (at 44.1kHz/16 or 24bit, 48kHz/16 or 24bit) : 8 real tracks + 48 additional tracks (at 88.2kHz/24bit, or 96kHz/24bit)
Recording Time (mono track)	: Approx. 3,770 minutes (20GB) (at 16bit/44.1kHz) : Approx. 1,150 minutes (20GB) (at 24bit/96kHz)
Pitch Control	: +/- 6% (0.1 step)
Crossfade	: 10msec, 5msec (at 24bit/96kHz)
R/P Freq. Response	: 20Hz to 20kHz (at fs: 44.1/44.8kHz) : 20Hz to 43kHz +/-2dB (at fs: 96kHz)
Dynamic Range	: More than 108dB (typical)

### Inputs/Outputs

- \* Input/Output (0dBu=0.775Vrms, 0dBV=1Vrms)
- \* Ref. Level : -12dB
- \* Switchable to balanced (+4dBu)/unbalanced (-10dBV), (Can be set by the SETUP mode; default: +4dBu).

#### Analog Input (1 to 24)

Connector	: TRS Phone jack (Balanced)
Input Impedance	: More than 10k Ω
Ref. Input Level	: +4dBu (Switchable to unbalanced/-10dBV.)

#### Analog Output (1 to 24)

Connector	: TRS Phone jack (Balanced)
Load Impedance	: More than 10k Ω
Ref. Output Level	: +4dBu (Switchable to unbalanced/-10dBV.)

#### Data Input (1-8, 9-16, 17-24)

Connector	: Optical
Format	: IEC 60958 (S/P DIF) Alesis Proprietary Multichannel Optical Digital Interface

\* INPUT 1-8 only are effective when using S/P DIF.

#### Data Output (1-8, 9-16, 17-24)

Connector	: Optical
Format	: IEC 60958 (S/P DIF) Alesis Proprietary Multichannel Optical Digital Interface

<Note>: The [DATA INPUT] and [DATA OUTPUT] connectors do not support 96kHz FS adat digital signals.

#### WORD Input

Connector	: BNC
Input Level	: TTL level

#### WORD Output

Connector	: BNC
Output Level	: TTL level

#### RS-422

Connector	: D-sub 9pin
Protocol	: Sony 9pin protocol, ES buss

#### RS-422 THRU

Connector	: D-sub 9pin
Output	: Direct output of RS-422

#### MIDI In/Out/Thru

Connector	: DIN 5pin
-----------	------------

#### Punch In/Out

Connector	: 6mm dia phone jack (optional model 8051)
-----------	---

### Physical

Dimensions	: 482 (W) x 141 (H) x 381 (D) mm
Weight	: 7.0kg (included remote controller)
Power Requirement	: 120VAC 50/60Hz 230VAC 50/60Hz 240VAC 50/60Hz
Power Consumption	: 60W

\* Specifications and appearance are subject to change without notice for product improvement.

\* "Adat" and the  symbol are trademarks of Alesis Corporation.

\* FDMS-3: Fostex Disk Management System-3 Ver.3

\* FDIO-1 Ver.2: Fostex Data In Out-1 Ver.2

# APPENDIX

## <Operation manual for the recorder with the Model 8346 TC/SYNC card installed>

This appendix is the operation manual for the recorder with the Model 8346 TC/SYNC card installed.

### <Installation of the optional card>

The TC/SYNC card should be installed into the recorder at a FOSTEX service station. Do not try to install the card by yourself. Ask your local FOSTEX dealer for the installation after purchasing the Model 8346.

### <Notes when requesting the installation>

There is the possibility of damaging the hard disk when transporting the recorder. Before transporting the recorder to our service department for the installation of the TC/SYNC card, remove the hard disk from the recorder. Be sure to keep the removed hard disk carefully.

## Contents of Appendix

<b>Names and Functions .....</b>	<b>3</b>
<b>Introduction .....</b>	<b>4</b>
<b>Additional features .....</b>	<b>4</b>
<b>Operations for the additional SETUP menu .....</b>	<b>4</b>
“Ref. TC ?” menu setting .....	4
“Clock Sel ?” menu setting .....	5
“Sync Preset ?” menu setting .....	5
“Virtual LTC ?” menu setting .....	6
“Offset Disp ?” menu setting .....	6
<b>Generator Setup .....</b>	<b>7</b>
How to enter the Generator Setup mode .....	7
Setting the time code recording mode .....	7
Editing the internal generator time code .....	8
Force jamming to external time code .....	8
Selecting the output time code .....	8
TC output setting at PAUSE .....	9
Editing the chase offset .....	9
Erasing the recorded time code .....	9
<b>Chase sync to external time code .....</b>	<b>10</b>
<b>Synchronization to word clock or video signal .....</b>	<b>11</b>
<b>Connection to a digital mixing console .....</b>	<b>11</b>
<b>Control from a video editor (RS-422) .....</b>	<b>13</b>

## Names and Functions

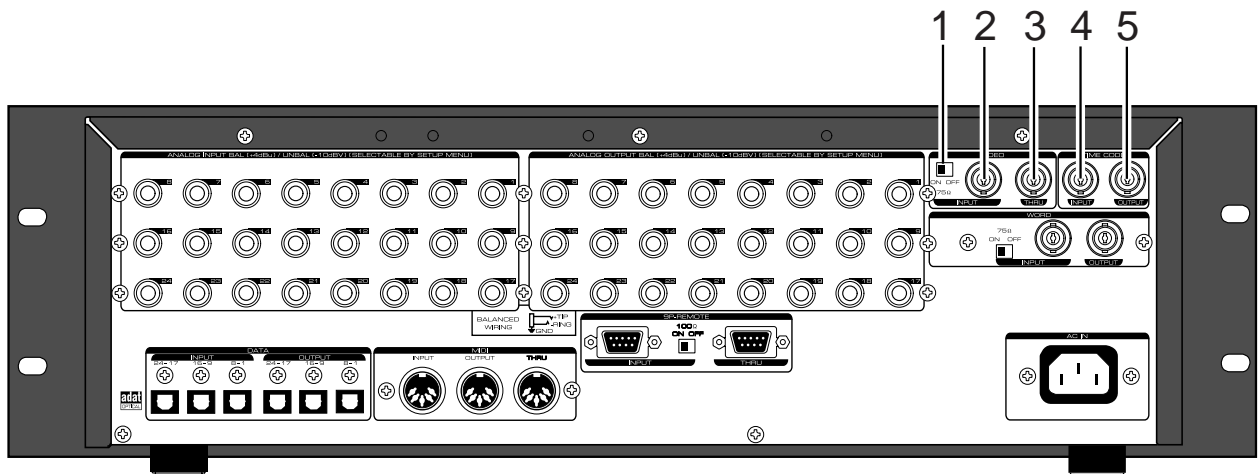

1. **[VIDEO IN] termination switch (75Ω termination ON/OFF)**  
Used to terminate the VIDEO INPUT signal and usually set to ON.
2. **[VIDEO IN] connector (BNC connector)**  
Receives an external video sync signal (inter-lace or composite) when synchronizing the recorder to a video sync signal.
3. **[VIDEO THRU] connector (BNC connector)**  
Outputs the video sync signal received from the VIDEO INPUT connector.
4. **[TIME CODE INPUT] connector (BNC connector)**  
Receives external time code (LTC).
5. **[TIME CODE OUTPUT] connector (BNC connector)**  
Outputs an LTC from the recorder (equivalent to the MTC displayed on the panel) or time code from the internal TC generator.

## Introduction

The Model 8346 is a TC/SYNC card designed as an option for digital multitrack recorders.

By installing the TC/SYNC card into the recorder, the recorder can synchronize to external LTC or video signal, as well as an external word clock.

So you can use the recorder synchronized with video machines in video post production studios where the synchronization between audio and video is indispensable, or make digital sound recordings in a system using a digital mixing console.

## Additional features

By installing the Model 8346 into the recorder, the following SETUP menus and GEN setup function are added. These SETUP menus are used when the recorder is synchronized to an external LTC or locked to a video signal.

### 1. SETUP mode "Ref. TC?" menu

This menu selects the reference time code used as a master time code for the recorder.

The reference time code can be selected between MTC (MIDI time code) and LTC according to the incoming time code. The default setting after formatting a disk is "LTC".

### 2. SETUP mode "Clock Sel?" menu

This menu selects the reference clock of the recorder with the 8346.

If the 8346 is not installed, you can select the reference clock from "Int," "Auto" and "Word".

If the 8346 is installed, "Video" also can be the reference clock in addition to the three options above.

### 3. SETUP mode "Sync Preset?" menu

This menu is effective when the recorder with the 8346 installed is used in sync with a digital mixing console.

You can select from some preset options according to your system to get the best synchronization performance.

### 4. SETUP mode "Virtual LTC?" menu

This menu selects whether recording/playback of the virtual LTC is enabled or disabled. The default setting is "Ena." (Enabled).

### 5. SETUP mode "Offset Disp?" menu

This menu selects whether or not displaying the real offset between the incoming reference time code (LTC or MTC) and the displayed LTC.

The real offset is displayed instead of REMAIN when displaying the LTC.

### 6. GENERATOR setup functions

The GENERATOR setup functions allows recording/erasing an external or internal (generator) time code, force-jamming to external time code, setting the LTC output, and setting the chase offset value between incoming time code and the LTC.

## Operations for the additional SETUP menu

### • "Ref. TC?" menu setting

1. Turn on the power of the recorder.
2. Press the [SETUP] key while the recorder is stopped to show the SETUP menu.
3. Select the "Ref. TC?" menu by using the Jog dial and press the [EXECUTE/YES] key.

The reference time code currently selected starts flashing (the default reference time code setting when the Model 8346 is installed is "LTC").

The outlined box surrounds the flashing item on the display.

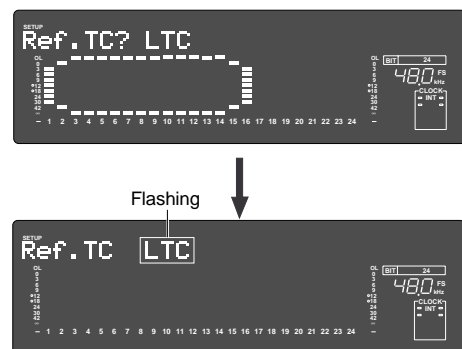

4. Select the reference time code by using the Jog dial.  
You can select between "LTC" and "MTC" (MIDI time code).
5. After selecting the reference time code, press the [EXECUTE/YES] key.  
The selected reference time code is confirmed (set) and the display changes to the similar one to the upper example in step 3 above where "?" flashes.
6. Press the [EXIT/NO] key (or the [STOP] button) to exit the SETUP mode.

You can check the time information of the incoming reference time code in the front panel display of the recorder.

See "Chase sync to external time code" below for details.



• **"Clock Sel?" menu setting**

Execute step 1 and 2 in "Ref. TC ?" menu setting" described above.

3. **Select the "Clock Sel?" menu by using the Jog dial and press the [EXECUTE/YES] key.**  
The reference clock currently selected starts flashing (the default reference clock setting when the Model 8346 is installed is "INT").

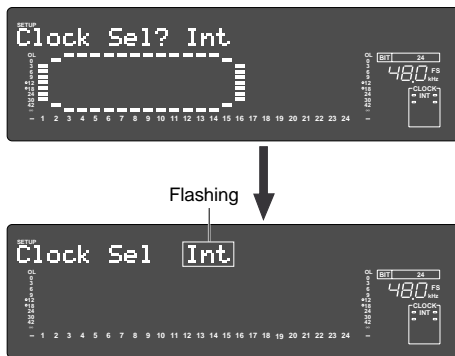

4. **Select the desired reference clock by using the Jog dial.**  
You can select from "Auto," "Word" and "Video" as well as "Int". The following table shows the function of each option.

Reference clock	Function
<b>Auto</b>	The reference clock is automatically selected from among available clocks according to the following order of priority; Word, Video and Int.
<b>Int</b>	The 8346 references to the internal clock.
<b>Word</b>	The 8346 references to an external word clock.
<b>Video</b>	The 8346 references to an external video clock.

5. **After selecting the reference clock, press the [EXECUTE/YES] key.**  
The selected reference clock is confirmed (set) and the display changes to the similar one to the upper example in step 3 above where "?" flashes.
6. **Press the [EXIT/NO] key (or the [STOP] button) to exit the SETUP mode.**

• **"Sync Preset?" menu setting**

Execute step 1 and 2 in "Ref. TC ?" menu setting" described earlier.

3. **Select the "Sync Preset ?" menu by using the Jog dial and press the [EXECUTE/YES] key.**  
The sync preset setting currently selected is shown (the default setting when the Model 8346 is installed is "Int. Vari? Ana.>").

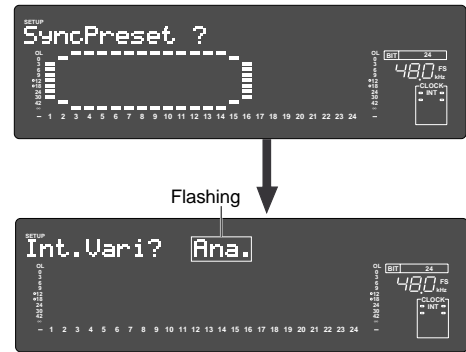

4. **Select the desired sync preset combination by using the Jog dial from the followings;**  
The following table shows the function of each preset.

Preset item		D. in ? setting	8346 Clock	Slave Type
<b>Int. Vari</b>	<b>Ana.</b>	Not assigned	Int	Vari
	<b>adat</b>	adat ;Async		
<b>Int. Free</b>	<b>Ana.</b>	Not assigned	Int	Free
	<b>adat</b>	adat ;Async		
<b>Word Free</b>	<b>Ana.</b>	Not assigned	Word	Free
	<b>adat</b>	adat ;Async		
<b>Video Vari</b>	<b>Ana.</b>	Not assigned	Video	Vari
	<b>adat</b>	adat ;Async		
<b>Video Free</b>	<b>Ana.</b>	Not assigned	Video	Free
	<b>adat</b>	adat ;Async		

5. **After selecting the preset, press the [EXECUTE/YES] key.**  
The selected preset is confirmed (set) and the display changes to the similar one to the upper example in step 3 above where "?" flashes.
6. **Press the [EXIT/NO] key (or the [STOP] button) to exit the SETUP mode.**

• **"Virtual LTC?" menu setting**

Execute step 1 and 2 in ""Ref. TC ?" menu setting" described earlier.

3. **Select the "Virtual LTC?" menu by using the Jog dial and press the [EXECUTE/YES] key.**  
The current setting is flashing (the default setting when the Model 8346 is installed is "Ena." (enable)).

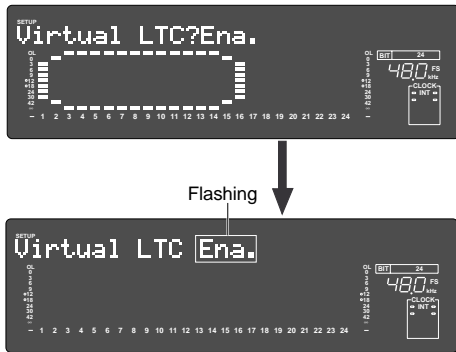

4. **Select "Ena." or "Dis." by using the Jog dial.**

Selection	Function
<b>Ena. (Enable)</b>	Enables recording/playback of the virtual LTC.
<b>Dis. (Disable)</b>	Disables recording/playback of the virtual LTC. This setting is used when you want to chase the recorder using only the MTC offset setting, ignoring the recorded LTC. With this setting, the TIME CODE OUT terminal outputs MTC or LTC with the MTC offset.

5. **After selecting "Ena." or "Dis.", press the [EXECUTE/YES] key.**
6. **Press the [EXIT/NO] key (or the [STOP] button) to exit the SETUP mode.**

**<CAUTION>**

Do not set the Virtual LTC to "Ena." for a disc on which data was recorded by the FDMS-3 Ver. 1.0 format using the machines such as D-160 and D108. Otherwise, it may cause malfunction because the FDMS-3 Ver. 1.0 does not support the Virtual LTC.

• **"Offset Disp?" menu setting**

Execute step 1 and 2 in ""Ref. TC ?" menu setting" described earlier.

3. **Select the "Offset Disp?" menu by using the Jog dial and press the [EXECUTE/YES] key.**  
The current setting is flashing (the default setting when the Model 8346 is installed is "Off").

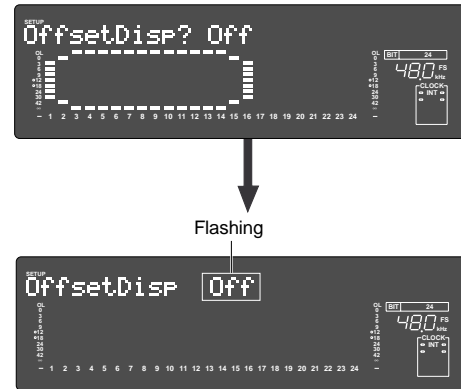

4. **Select "Off" or "On" by using the Jog dial.**

Selection	Function
<b>Off</b>	The real-offset value is not displayed.
<b>On</b>	The real-offset value is displayed instead of the REMAIN time when the time base is set to MTC If you press the [STORE] key, the display shows "Catch Offset!" for a second, then changes to the edit mode display of the chase offset which will be explained in "GENERATOR Setup" later. After editing the chase offset, pressing the [EXECUTE/YES] key updates the real-off-set value.

5. **After selecting "Off" or "On", press the [EXECUTE/YES] key.**
6. **Press the [EXIT/NO] key (or the [STOP] button) to exit the SETUP mode.**

**<CAUTION>**

When the power is turned off, the Offset Disp mode returns to the default setting ("Off").

## Generator Setup

By installing the Model 8346 TC/SYNC card into the recorder, the Generator Setup functions activate and the following features are available.

1. Recording/playback of external or internally generated time code
2. Force jam to external time code
3. Outputting the internally generated or recorded time code
4. Setting of the chase offset between external time code and MTC

### How to enter the Generator Setup mode

1. **Press the [SETUP] key while holding down the [SHIFT] key.**  
The recorder enters the Generator Setup mode in which the following menus are available. The display will show "TC Gen.? Rec Run" (the default) when you first select the Generator Setup mode. However, from the second time, the menu selected last time will appear.

By rotating the **Jog** dial, the menus of the Generator Setup mode appear one after the other.

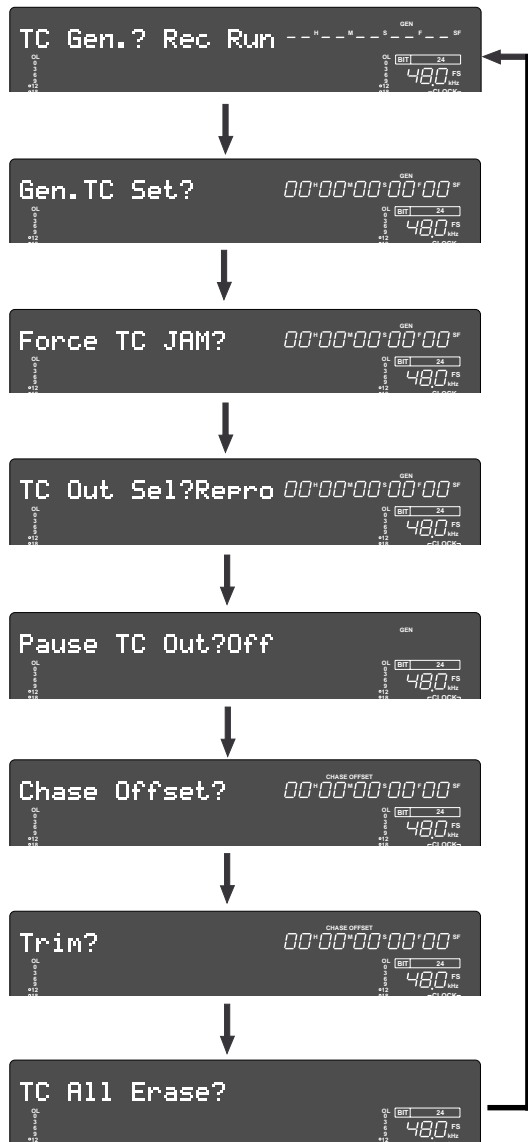

### Setting the time code recording mode

1. **Select "TC Gen.? Rec Run" of the Generator Setup mode and press the [EXECUTE/YES] key.**  
The recording mode currently selected starts flashing, showing that you are now ready to select the desired recording mode.

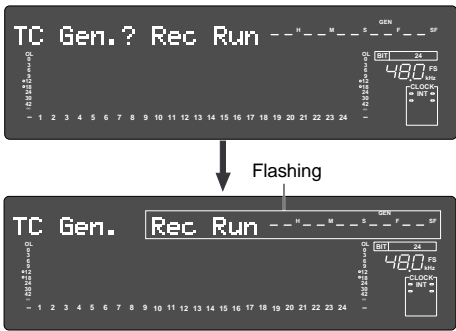

2. **Use the Jog dial to display the desired recording mode.**  
You can choose from 4 recording modes available.

Recording mode	Function
<b>Rec Run</b>	Time code that is continuous with the time code previously recorded will be recorded. This mode is also useful to re-record a discontinuous time code.
<b>Free Run</b>	Time code generated by the internal generator will be recorded.
<b>Ext Run</b>	External time code will be recorded.
<b>24H Run</b>	Time code generated by the internal generator will be recorded from the current time of the recorder's internal clock.

**<CAUTION>**  
The 8346 does not record all time code information. It records only the ABS time at the recording start point and the time code offset value. Therefore, if you record discontinuous time code in the middle, it cannot recognize it. Also note that because the user's bit at the recording start point is maintained, the 8346 cannot recognize user's bit change in the middle.

3. **Press the [EXECUTE/YES] key after selecting the recording mode.**

**<CAUTION>**  
When you create a new program using the program select function, the LTC with the same MTC offset (which you can see in the "MTC offset?" menu of the Setup mode) as the current program is recorded in the new program. Therefore, if you use the same LTC with the new program, you do not need to re-record LTC.

**<How to record time code>**

After setting the time code recording mode described above, record time code by the following procedure.

1. Press the [EDIT] key while holding down the [SHIFT] key to turn TC READY on (the TC READY indicator will flash).
2. Press the [PLAY] button while holding down the [RECORD] button (the TC READY indicator will light).

Unlike audio signal recording, you do not need to arm a track for time code.

Also note that recording time code does not consume the hard disk space.

To erase all the time code information, see "Erasing the recorded time code" described later.

**Editing the internal generator time code**

Editing the internal generator time code can be done only when the time code recording mode (described above) is set to "Free Run".

1. Select "Gen TC Set" of the Generator Setup mode and press the [EXECUTE/YES] key.  
The current internal generator time code is displayed and you are now ready to edit the time.



Flashing



2. Use the Shuttle dial to move the editing point (which is flashing), and use the Jog dial to set the numeric value.  
Up to 23H 59M 59S \*\*F (\*\* = current frame rate - 1) can be set.
3. After editing is completed, press the [EXECUTE/YES] key.

**Force jamming to external time code**

Force jamming to external time code can be done only when the time code recording mode (described above) is set to "Free Run". Note that the following description assumes that the 8346 is receiving external time code.

1. Select "Force JAM" ("SURE?" flashes) of the Generator Setup mode and press the [EXECUTE/YES] key.  
The force jamming to the external time code starts and the display shows the time code value in realtime.

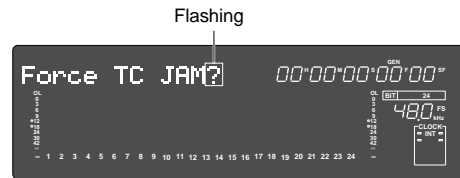

If the 8346 does not receive external time code correctly, the warning message "Void LTC In!" appears when pressing the [EXECUTE/YES] key.

**Selecting the output time code**

When the time code recording mode (described above) is set to "Free Run" or "24H Run", the 8346 can output the internal generator time code or recorded time code. Note that it does not output time code when the time code recording mode is set to "Rec Run" or "Ext Run".

**<CAUTION>**

- While time code is output, the recorder's vari pitch and word sync functions are prohibited. Note that the time code output setting is available only when an "Async" mode ("adat: Async" or "SPDIF: Async") is selected in the "D. in?" menu of the Setup mode. Also note that if you execute a program change, etc. the generator stops time code generation.
- The "TC Out Sel?" setting returns to the default "Repro" when turning the power off.

1. Select "TC Out Sel?" ("?" flashes) of the Generator Setup mode and press the [EXECUTE/YES] key. The current output setting flashes (the default setting is "Repro").



Flashing



2. Use the Jog dial to select "Repro" or "Gen.". The time code output from the [TIME CODE OUT] terminal changes according to the setting.

Output setting	Output time code
Repro	Reproduced time code
Gen.	Internal generator time code

3. After the setting is completed, press the [EXECUTE/YES] key.
4. Press the [EXIT/NO] key (or the [STOP] button) to exit the Generator Setup mode.

**TC output setting at PAUSE**

This sets up whether or not time code should be output or not, from [TIME CODE OUT] when the recorder is in PAUSE.

1. **Select “Pause TC Out?” (“?” flashes) of the Generator Setup mode and press the [EXECUTE/YES] key.**  
It will change to flashing of the presently set items. Initially, “Off” will be flashing.

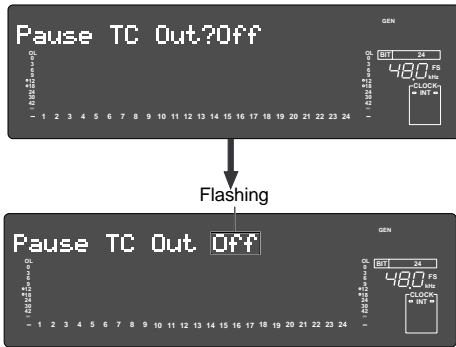

3. **Select “On” or “Off” with the Jog dial, and press the [EXECUTE/YES] key.**  
When set to “On”, time code will be output from the [TIME CODE OUT] port when the recorder is in the PAUSE mode.

**Editing the chase offset**

You can edit the chase offset value between external time code and LTC time.

**Setting the chase offset value numerically**

1. **Select “Chase Offset?” (“?” flashes) of the Generator Setup mode and press the [EXECUTE/YES] key.**  
You are now ready to edit the chase offset value.

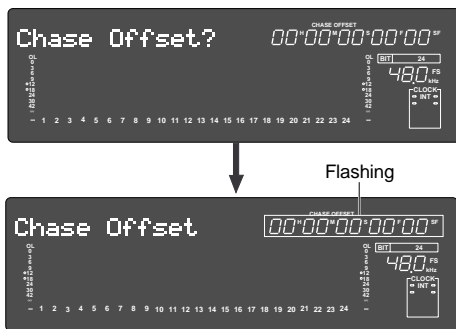

2. **Use the Shuttle dial to move the editing point (which is flashing), and use the Jog dial to set the desired value.**  
The offset value can be set between “-12H 00M 00S \*\*F 00SF” and “11H 59M 59S \*\*F 99SF” (where \*\* depends on the current frame rate set by the “Frame Rate?” menu of the Setup mode).
3. **After editing is completed, press the [EXECUTE/YES] key.**

The edited value becomes valid and the display changes to the similar one to the upper example in step 1 above where “?” flashes.

**Trimming of the chase offset value**

If this trimming is carried out in the chase locked state, offset can then be set in real time and is thus very effective.

1. **Select “Trim?” (where “?” flashes) of the Generator Setup mode and press the [EXECUTE/YES] key.**  
The display will show something like below, and now you are ready to trim the chase offset value.

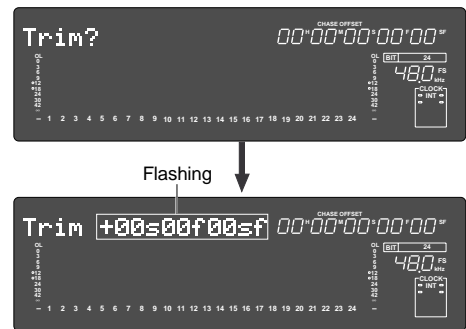

3. **Use the Jog dial to trim the chase offset value.**  
By rotating the Jog dial, you can trim the chase offset value in real-time in sub frame accuracy. However, if you exit the mode after the operation above (by skipping step 4), the offset returns to the original value. To make the new offset value effective, do not forget step 4 below.
4. **Press the [EXECUTE/YES] key to confirm (set) the offset value.**

**Erasing the recorded time code**

You can erase the recorded time code only while the recorder is stopped.

1. **Select “TC All Erase?” (where “?” flashes) of the Generator Setup mode and press the [EXECUTE/YES] key.**  
“?” disappears and “SURE?” starts flashing.

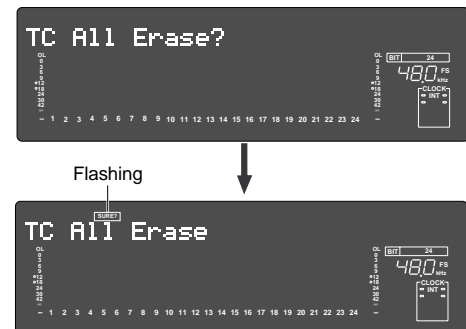

2. **Press the [EXECUTE/YES] key.**  
All the recorded time code is erased and the time code set by the MTC offset will become effective (from ABS 0 to 24H).

## Chase sync to external time code

The recorder with the Model 8346 installed can synchronize to incoming LTC by receiving the external LTC via the recorder's **[TIME CODE INPUT]** terminal and setting the recorder's slave mode to On.

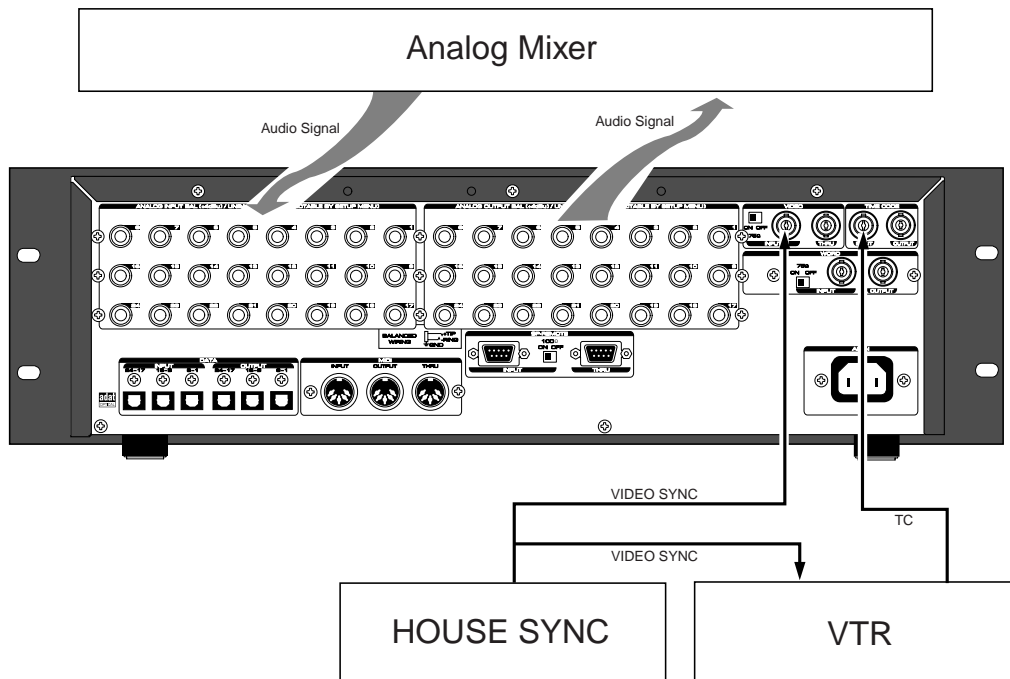

### Connection

In this example, the recorder with the 8346 is a slave while the VTR is a master. Feed the time code from the VTR to the TIME CODE INPUT terminal of the recorder with the Model 8346 to play the recorder in sync with the VTR. Also feed the video reference signal to both the VTR and recorder as shown above.

### Recorder settings

1. **Select the program to be played back.**
2. **Set the reference time code to "LTC" by using the "Ref. TC?" menu of the Setup mode.**
3. **Set the recorder's frame rate to the same rate as the incoming time code by the "Frame Rate ?" menu of the Setup mode.**  
The "Frame Rate?" menu of the Setup mode allows you to select the desired frame rate from 24, 25, 29nd, 29df, 30nd and 30df.
4. **Set the chase mode to ON by pressing the [EXECUTE/YES] key while holding down the [SHIFT] key.**
5. **Set the desired offset value by the "MTC OFFSET?" menu of the Setup mode.**  
By setting the desired offset value, the recorder will run with the offset between the VTR and recorder.

After all settings above are completed, press [EXIT/NO] key (or the [STOP] button) to exit the Setup mode.

### Time code display

You can monitor the incoming time code in the D2424LVmkII display window.

1. **Press the [DISP SEL] key while holding down the [SHIFT] key to select "LTC".**  
The display will show the current MTC offset value (the default setting is "00H 59M 57S 00F").
2. **While "LTC" is selected, press the DISP SEL key to select the time code display.**  
When the recorder is receiving LTC, the display shows the incoming LTC while "TC IN" lights in the display.

### Synchronization with the VTR

1. **Start playback of the VTR.**  
If an offset value is set, the recorder will start playback, chasing the time code from the VTR with maintaining the offset.

#### <CAUTION>

- The recorder can chase incoming time code within the range of continuously recorded time code. If there is a discontinuity in the recorded time code, when incoming time code runs across the discontinuous point, "Out of Zone!" will appear in the display and the recorder may stop chasing. If the time code corresponding to the incoming time code is recorded in a different area, play the recorder to that area.
- You can locate the recorder to the beginning of a discontinuous time code by pressing the [NEXT] or [PREV] key while holding down the [SHIFT] key.

## Synchronization to word clock or video signal

The recorder with the Model 8346 installed can synchronize to an external sync signal such as word clock and video composite signal.

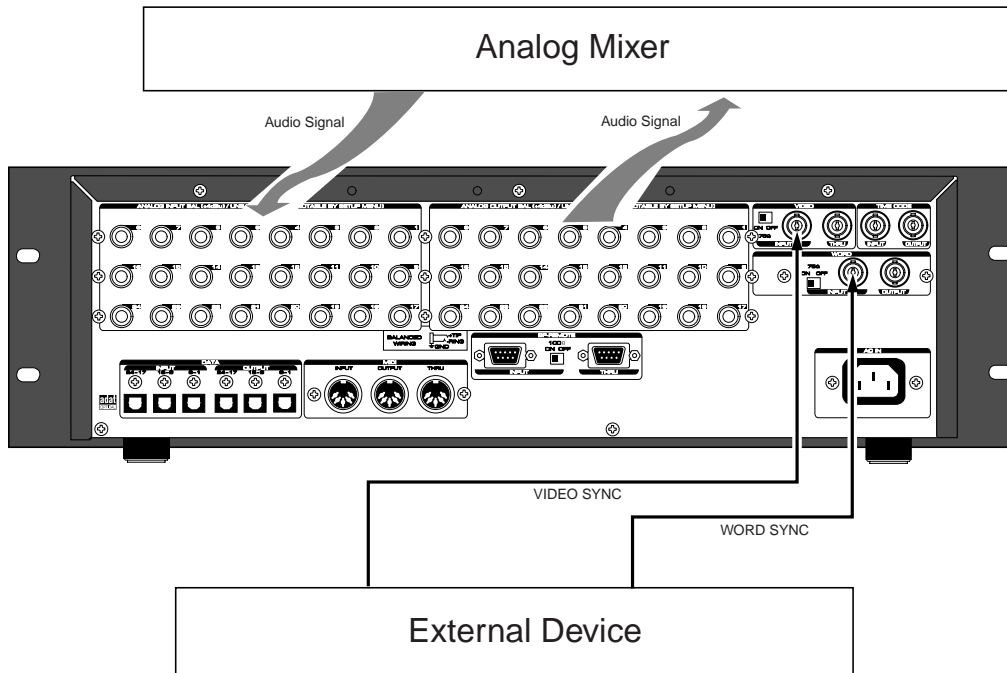

### Connection

In this example, according to the external device, feed video or word sync signal to the WORD INPUT or VIDEO INPUT terminal of the recorder.

### Recorder's settings

1. Select the program to be played back.
2. Set the reference clock to "Word" or "Video" according to the incoming sync signal by using the "Clock Sel?" menu of the Setup mode.

**<CAUTION>**  
If you use word clock as the reference clock, the sampling frequencies of the external device and the recorder must match.  
Because the sampling frequency of the recorder is set when formatting the disk, make sure of the sampling frequency of the external device before you start working.



## Connection to a digital mixing console

The recorder with the Model 8346 installed can connect to a digital mixing console and record an adat digital signal from the console.

In this example, the recorder receives external LTC from a VTR, etc., locks to the time code, and returns the locking information to the digital mixing console via the digital mixer. In this process, the digital console outputs the adat digital signal to the recorder with the timing in sync with the receiving word clock. See the connection example on the next page.

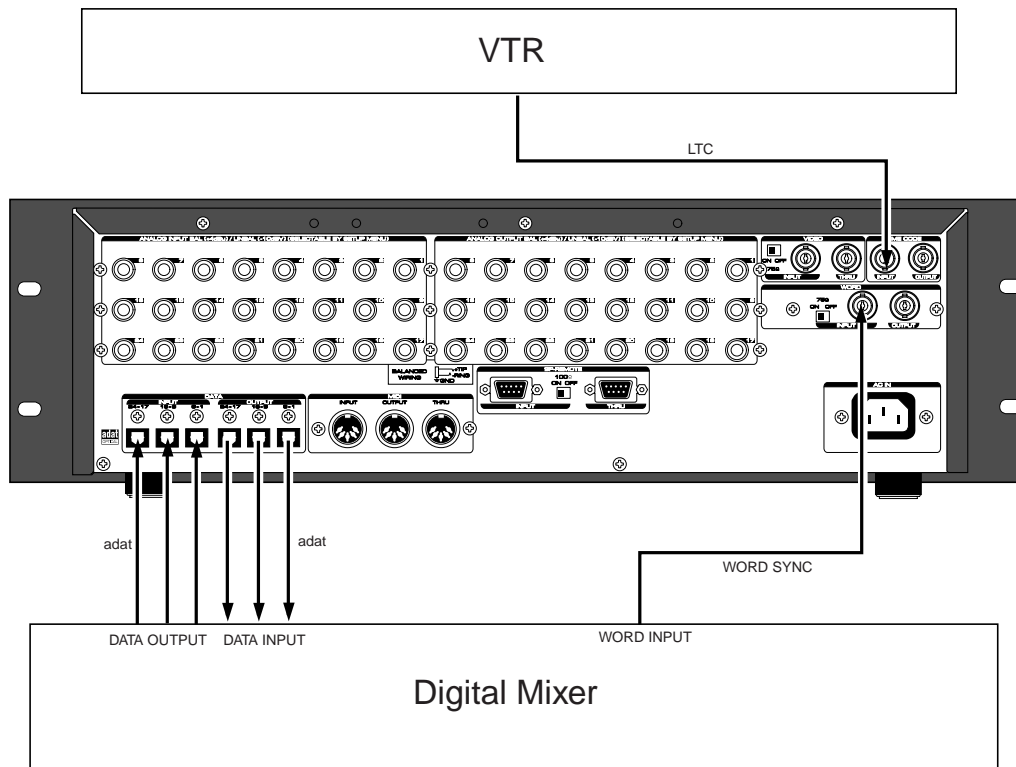

### Recorder's settings

1. Set the preset to "Int. Vari adat" by using the "Sync Preset?" menu of the Setup mode.  
By selecting "Int. Vari adat", the recorder is set as follows.

Digital signal -> adat: Async  
Reference clock -> Int (internal)  
Slave type -> Vari

2. Set the reference time code to "LTC" by using the "Ref TC?" menu of the Setup mode.

### Digital mixing console's settings

1. Set the clock source of the digital mixing console to "WORD" and the input to "Adat".



## Control from a video editor (RS-422)

The recorder with the Model 8346 installed can be used for audio editing for video using a video editor. Connect a video editor to the recorder's REMOTE IN (RS-422) terminal, as well as connect a video sync signal to the recorder, video editor and VTR as the reference signal. With this connection example, you can edit audio for video by controlling the VTR and recorder from the video editor.

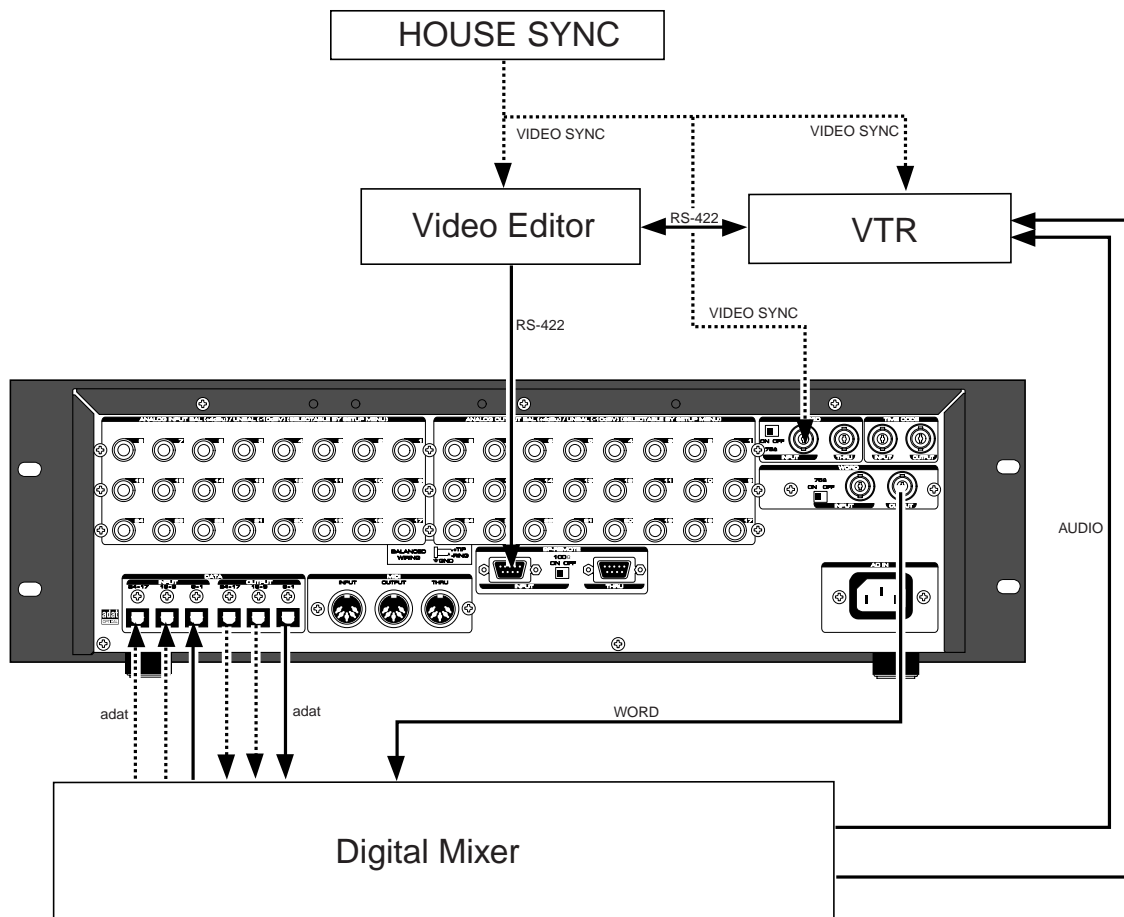

### Recorder's settings

1. Set the preset to "Video Free adat" by using the "Sync Preset?" menu of the Setup mode. By selecting "Video Free adat", the recorder is set as follows.

Digital signal -> adat: Async  
 Reference clock -> Video  
 Slave type -> Free

### Digital mixing console's settings

1. Set the reference clock of the digital mixing console to "WORD".

**<CAUTION>**  
 Most popular video editors can be used with the recorder/8346, however, we cannot guarantee that all video editors can be used or all functions work correctly (also note that the recorder/8346 does not support audio editors). We recommend to check whether functions work correctly or inquire to the manufacturer/dealer of an editor before using/purchasing. Also refer to the "Basic parameter settings for editors" below when using an editor.

**<Basic parameter settings for editor>**  
 We recommend to set editor parameters as shown below when controlling the recorder. Note that these settings are just for reference and we cannot guarantee all functions work correctly with the settings.

- Preroll time: more than 5 seconds
- Edit delay: 0 frame
- EE delay: 0 frame
- Over run: 0 frame
- Trajectory: "Cue with Data command" is recommended
- Start delay: 0 frame (depending on editors)

# Declaration of EC Directive

This equipment is compatible with the EMC Directive (2004/108/EC) - Directive on approximation of member nation's ordinance concerning the electromagnetic compatibility and with the Low Voltage Directive (73/23/EEC) - Directive on approximation of member nation's ordinance concerning electric equipment designed to be used within the specified voltage range.

## The Affect of Immunity on This Equipment

The affect of the European Specification EN61000-6-1 (coexistence of electromagnetic waves - common immunity specification) on this equipment are as shown below.

In the electrical fast transient/burst requirements, surge, conducted disturbances by radio-frequency fields, power frequency magnetic field, radiate electromagnetic field requirements and static electricity discharging environment, this could be affected by generation of noise in some cases.

## FOSTEX DISTRIBUTORS LIST IN EUROPE

\* Including non-EU countries (as of March, 2007)

### <AUSTRIA>

NAME: ATEC Audio-u. Videogeraete VertriebsgesmbH.  
ADD: Im Winkel 5, A-2325 Velm, Austria  
TEL: (+43) 2234-74004, FAX: (+43) 2234-74074

### <BELGIUM>

NAME: General Audio  
ADD: Raymond Pelgrimslaan 101, B-1702 Groot-Bijgaarden, Belgium  
TEL: (+32) 2-4630650, FAX: (+32) 2-4661500

### <DENMARK>

NAME: SC Sound ApS  
ADD: Malervej 2, DK-2630 Taastrup, Denmark  
TEL: (+45) 4399-8877, FAX: (+45) 4399-8077

### <FINLAND>

NAME: Noretron Oy Audio  
ADD: P. O. Box 22, FIN-02631 Espoo, Finland  
TEL: (+358) 9-5259330, FAX: (+358) 9-52593352

### <FRANCE>

NAME: Sennheiser France  
ADD: 128 bis, avenue Jean-Jaures, 94851 Ivry-sur-Seine Cedex, France  
TEL: (+33) 1 4987 0300, FAX: (+33) 1 4987 0324

### <GERMANY>

NAME: Mega Audio GmbH  
ADD: Stromberger Str. 32, D-55411 Bingen, Germany  
TEL: (+49) 6721-94330, FAX: (+49) 6721-32046

### <GREECE>

NAME: Bon Studio S. A.  
ADD: 6 Zaimi Street, Exarchia, 106.83 Athens, Greece  
TEL: (+30) 210-3809-605, 606, 607, 608  
FAX: (+30) 210-3845-755, 210-3827-868

### <ICELAND>

NAME: I. D. elrf. electronic Ltd.  
ADD: ARMULA 38 108 REYKJAVIK, ICELAND  
TEL: (+354) 588 5010, FAX: (+354) 588 5011

### <ITALY>

NAME: Proel S. p. A.  
ADD: Zona Via Alla Ruenia, 37/43 64027 -Sant'Omero (Teramo), Italy  
TEL: (+39) 0861-81241, FAX: (+39) 0861-887862

### <THE NETHERLANDS>

NAME: IEMKE ROOS AUDIO B. V.  
ADD: Kuiperbergweg 20, 1101 AG Amsterdam, The Netherlands  
TEL: (+31) 20-697-2121, FAX: (+31) 20-697-4201

### <NORWAY>

NAME: Siv. Ing. Benum AS  
ADD: P.O. Box 145, Vinderen, 0319 Oslo, Norway  
TEL: (+47) 2213 9900, FAX: (+47) 2214 8259

### <SPAIN>

NAME: Letusa S. A.  
ADD: C/Laguna 10, 28923 Alcorcon, Madrid, Spain  
TEL: (+34) 91-4862800, 91-4470898  
FAX: (+34) 91-6414597

### <SWEDEN>

NAME: Kinovox-Benum A/B  
ADD: Solna Strandvag 78 171 54 Solna, Sweden  
TEL: (+46) 8 5052 1176, FAX: (+46) 8 5052 1010

### <SWITZERLAND>

NAME: Audio Bauer Pro AG  
ADD: Bernerstrasse-Nord 182, CH-8064 Zurich, Switzerland  
TEL: (+41) 1-4323230, FAX: (+41) 1-4326558

### <UK>

NAME: SCV London  
ADD: 40 Chigwell Lane, Oakwood Hill Industrial Estate, Loughton, Essex IG10 3NY U. K.  
TEL: (+44) 20-8418-0778, FAX: (+44) 20-8418-0624

# FOR THE US CUSTOMERS ONLY

## FOSTEX AMERICA LIMITED WARRANTY

The following statement defines specific legal rights. You may also have additional rights depending on the state in which the Fostex product was purchased.

### WARRANTY PROTECTION

All Fostex parts are warranted for one (1) year from the date of original purchase, except for recording media, such as hard disc drives and compact flash cards, heads, lamps and fuses, which are warranted, for one hundred-eighty (180) days. Fostex America will repair and / or replace parts during the term of this warranty. Labor costs are also covered by Fostex America for one (1) year from the date of original purchase. Except as specified below, this warranty covers all defects in material and workmanship in this product.

The following are not covered by this warranty:

1. Batteries.
2. Damage to any product that has been altered.
3. Damage to any product on which the original serial number has been defaced, modified or removed.
4. Damage to or deterioration of the external cabinet.
5. Damage occurring during shipment of the product. (**NOTE:** Shipping claims must be presented to the carrier.)
6. Damage resulting from accident, misuse, abuse or neglect.
7. Damage resulting from failure to perform routine maintenance and / or calibration procedures.
8. Damage resulting from failure to follow instruction in the owner's manual.
9. Damage resulting from repair or attempted repair or by someone other than a Fostex America Service technician or a technician at an authorized Fostex America service station.
10. Damage resulting from causes other than product defects, including lack of technical skill, competence or experience on the part of the user.
11. External appearance items such as cosmetic parts, knobs, liquid crystal displays, buttons, etc.
12. Replacements or repairs necessitated by loss or damages resulting from any cause beyond the control of Fostex America.
13. Damage resulting from misuse or abuse on rental units.

**NOTE: FOSTEX AMERICA IS NOT RESPONSIBLE FOR DATA LOST OR DAMAGED DURING OPERATION OF THIS PRODUCT.  
CALIBRATION AND MAINTENANCE PROCEDURES ARE NOT COVERED BY THIS WARRANTY.**

Fostex America reserves the right to inspect all products submitted pursuant to this warranty. If such an inspection shows reasonable cause to believe that any of the above exclusions to the above warranty are applicable, then Fostex America or the authorized service station will charge prevailing service rates and parts, costs for any repairs.

## **FOSTEX AMERICA LIMITED WARRANTY**

To claim all warranty service, first access [www.fostex.com](http://www.fostex.com) to receive service authorization (RMA number). Then present the authorization together with the bill of sale, which shows the date of original purchase to Fostex America. This warranty is not transferable.

### **SHIPPING**

If this product needs service, you must take it, or package it carefully, using ample packaging materials to prevent damage during shipment and mail it to the distributor from whom you have purchased this product, postage pre-paid and insured.

**NOTE:** Fostex America will not assume responsibility for damages or losses occurred in transit, but will reasonably assist the sender in processing any claims whenever possible (such as submitting statements to the carriers when applicable).

Any collect or C.O.D. shipments will be refused. In order to obtain warranty repairs, you must include the following:

1. Date proof of original purchase (copy of bill of sale or charge slip).
2. A note describing the problem with sufficient particularity to allow Fostex America to inspect or adjust the problem.
3. All accessory items appurtenant to that problem.

### **LIMITATIONS OF IMPLIED WARRANTIES AND EXCLUSIONS OF CERTAIN DAMAGES**

Unless considered unenforceable or unlawful under applicable law:

- A. All implied warranties - including warranties of merchantability and fitness for a particular purpose - are limited in duration to term of this warranty and to the express coverage of this warranty;
- B. Fostex America's liability for any defect product is expressly limited to repair or replacement of the product, at the sole discretion and / or option of Fostex America. Fostex America shall not under any circumstances be liable for:
  1. Damaged based on inconvenience, loss of use of the product, loss of time, interrupted operation or commercial loss, OR;
  2. Any damages, whether incidental, consequential or otherwise, except damages which may not be excluded by under applicable law.
- C. Fostex America makes no other warranties, express or implied, above and / or beyond the representations made herein.

### **WARRANTY APPLIES ONLY TO THOSE PRODUCTS SOLD AND DISTRIBUTED BY FOSTEX AMERICA**

Service Department

**FOSTEX AMERICA**

9 Mars Court Boonton, NJ 07005

TEL: 973-394-0015 FAX: 973-394-0800

Email: [support@fostexusa.com](mailto:support@fostexusa.com)

Web: [www.fostex.com](http://www.fostex.com)



**FOStex**<sup>®</sup>

**FOSTEX CO.**

3-2-35 Musashino, Akishima-shi, Tokyo, Japan 196-0021