



FOSTEX

Digital Master Recorder

Model D-15

Owner's Manual

	CAUTION RISK OF ELECTRIC SHOCK DO NOT OPEN	
<p>CAUTION: TO REDUCE THE RISK OF ELECTRIC SHOCK, DO NOT REMOVE COVER (OR BACK). NO USER-SERVICEABLE PARTS INSIDE. REFER SERVICING TO QUALIFIED SERVICE PERSONNEL.</p>		

CAUTION:
TO PREVENT ELECTRIC SHOCK, MATCH WIDE BLADE OF PLUG TO WIDE SLOT, FULLY INSERT.

ATTENTION:
POUR ÉVITER LES CHOCS ÉLECTRIQUES, INTRODUIRE LA LAME LA PLUS LARGE DE LA FICHE DANS LA BORNE CORRESPONDANTE DE LA PRISE ET POUSSER JUSQU' AU FOND.



The lightning flash with arrowhead symbol, within an equilateral triangle, is intended to alert the user to the presence of uninsulated "dangerous voltage" within the product's enclosure that may be of sufficient magnitude to constitute a risk of electric shock to persons.



The exclamation point within an equilateral triangle is intended to alert the user to the presence of important operating and maintenance (servicing) instructions in the literature accompanying the appliance.

"WARNING"

"TO REDUCE THE RISK OF FIRE OR ELECTRIC SHOCK, DO NOT EXPOSE THIS APPLIANCE TO RAIN OR MOISTURE."

SAFETY INSTRUCTIONS

1. Read Instructions - All the safety and operating instructions should be read before the appliance is operated.
 2. Retain Instructions - The safety and operating instructions should be retained for future reference.
 3. Heed Warnings - All warnings on the appliance and in the operating instructions should be adhered to.
 4. Follow Instructions - All operating and use instructions should be followed.
 5. Water and Moisture - The appliance should not be used near water - for example, near a bathtub, washbowl, kitchen sink, laundry tub, in a wet basement, or near a swimming pool, and the like.
 6. Carts and Stands - The appliance should be used only with a cart or stand that is recommended by the manufacturer.
- 
- An appliance and cart combination should be moved with care. Quick stops, excessive force, and uneven surfaces may cause the appliance and cart combination to overturn.
7. Wall or Ceiling Mounting - The appliance should be mounted to a wall or ceiling only as recommended by the manufacturer.
 8. Ventilation - The appliance should be situated so that its location or position does not interfere with its proper ventilation. For example, the appliance should not be situated on a bed, sofa, rug, or similar surface that may block the ventilation openings; or, placed in a built-in installation, such as a bookcase or cabinet that may impede the flow of air through the ventilation openings.
 9. Heat - The appliance should be situated away from heat sources such as radiators, heat registers, stoves, or other appliances (including amplifiers) that produce heat.
 10. Power Sources - The appliance should be connected to a power supply only of the type described in the operating instructions or as marked on the appliance.
 11. Grounding or Polarization - The precautions that should be taken so that the grounding or polarization means of an appliance is not defeated.
 12. Power Cord Protection - Power supply cords should be routed so that they are not likely to be walked on or pinched by items placed upon or against them, paying particular attention to cords at plugs, convenience receptacles, and the point where they exit from the appliance.
 13. Cleaning - The appliance should be cleaned only as recommended by the manufacturer.
 14. Nonuse Periods - The power cord of the appliance should be unplugged from the outlet when left unused for a long period of time.
 15. Object and Liquid Entry - Care should be taken so that objects do not fall and liquids are not spilled into the enclosure through openings.
 16. Damage Requiring Service - The appliance should be serviced by qualified service personnel when:
 - A. The power supply cord or the plug has been damaged; or
 - B. Objects have fallen, or liquid has been spilled into the appliance; or
 - C. The appliance has been exposed to rain; or
 - D. The appliance does not appear to operate normally or exhibits a marked change in performance; or
 - E. The appliance has been dropped, or the enclosure damaged.
 17. Servicing - The user should not attempt to service the appliance beyond that described in the operating instructions. All other servicing should be referred to qualified service personnel.

Table of Contents

Introduction

How to read this manual.....	6
Outline of this manual.....	6
Contents of this manual.....	7

Chapter 1. Outline and Outstanding Features

1-1. General Outline.....	8
1-2. Outstanding Features.....	8

Chapter 2. Names and Functions

2-1. Front Panel.....	11
2-2. Display.....	23
2-3. Rear Panel.....	28

Chapter 3. Preliminary Notes

3-1. Precaution in operation.....	34
3-1-1. Precautions for installation.....	34
3-1-2. Precautions on dewing.....	34
3-1-3. The Internal Clock.....	34
3-1-4. Notes on Safety.....	35
3-2. DAT.....	36
3-2-1. DAT Specifications.....	36
3-2-2. On the A-Time (absolute time).....	38
3-2-3. The DAT Cassette Tape.....	38
3-2-4. Erase Protect Hole.....	39
3-2-5. Loading and Ejecting of the Tape.....	39
3-2-6. Non-recorded Section and No Sound Recorded Section.....	40
3-2-7. The Sub ID.....	41
3-3. Setting the Internal Clock.....	41
3-4. The rack mount adaptor.....	43

Chapter 4. Record and Playback

4-1. Basic Playback.....	45
4-2. Basic Recording.....	46
4-2-1. Analog Audio Recording.....	46
4-2-2. Digital Audio Signal Recording.....	49
4-3. Making a No Sound Recorded Section (REC MUTE).....	50
4-4. Blank Search.....	51
4-5. AUTO REC (The Auto Recording) Mode.....	52
4-5-1. Setup of Memory [00] and Memory [01].....	52
4-5-2. Rehearsal of AUTO REC.....	54
4-5-3. Changing the memory data (Punch in/out point).....	55
4-5-4. Execution (take) of AUTO REC.....	57

4-6. Cueing.....	58
4-6-1. Cueing by the JOG/SHTL mode.....	58
4-6-2. Cueing by the RAM SCRUB mode.....	59
4-7. The Search/Locate Function.....	60
4-7-1. S-ID Search.....	61
4-7-2. Locating Using P NO (Program Number).....	62
4-7-3. Locating With the MEM NO (Memory Numbers).....	63
4-7-4. Time Locate.....	64
4-8. The INSTANT START Mode.....	65
4-8-1. INSTANT START Operation.....	65
4-8-2. Executing INSTANT START after Moving the start point.....	66
4-8-3. Preview of INSTANT START by the PREVIEW/REPEAT key.....	67
4-8-4. Trimming of INSTANT START via the [PREVIEW/REPEAT] key.....	68
4-8-5. Locating Using INSTANT START.....	69
4-9. The AUTO CUE mode.....	70
4-9-1. S-ID Search/P NO locate in AUTO CUE mode.....	71
4-9-2. When tape is loaded in the AUTO CUE mode.....	72

Chapter 5. Record/Erase of Sub-ID

5-1. Recording of Start ID/Program No.....	74
5-1-1. Automatic Recording of S-ID/P NO During a Recording.....	74
5-1-2. Record of S-ID/P NO at a Random Point During a Recording.....	75
5-1-3. Recording of new S-ID/P NO during playback of a prerecorded tape.....	76
5-1-4. Automatic recording of S-ID/P NO during the manual or automatic recording operation.....	78
5-1-5. Re-recording a continuous P NO (renumbering function) from the head of the tape.....	79
5-1-6. Erasing S-ID/P NO.....	80
5-2. Record/Erase of SKIP-ID.....	82
5-2-1. Recording of SKIP-ID at any point during a recording.....	82
5-2-2. After rehearsal, record SKIP-ID during playback of a prerecorded tape.....	83
5-2-3. Erasing the SKIP-ID.....	84
5-3. Record/Erase of END-ID.....	85
5-3-1. Record the END-ID at any position during a recording.....	85
5-3-2. Do rehearsal, then record END-ID during playback of a prerecorded tape.....	86
5-3-3. Erasing the END-ID.....	88

Chapter 6. Memory Edit Mode

6-1. Store/recall/editing of memory data.....	90
6-1-1. Store in real time the present time.....	90
6-1-2. Checking (recall) time information of the specified memory number.....	91
6-1-3. Editing the memory number/time data.....	93

Chapter 7. The SETUP Mode

7-1. The SETUP mode items.....	96
7-2. Procedure for entering the SETUP mode.....	96
7-3. Executing the SETUP menu.....	99
7-3-1. Confirming the ROM version.....	99
7-3-2. Selecting the reference level.....	100
7-3-3. Setting the skip play mode.....	101
7-3-4. Selecting the pause off time.....	102
7-3-5. Selecting the mode for recording S-ID/P NO into the record starting point.....	103
7-3-6. Setup of panel lock ON/OFF.....	104
7-3-7. Setting the peak hold time.....	105
7-3-8. Setting the cue level for execution of AUTO CUE/AUTO-ID.....	106
7-3-9. Setup of cue time at execution of AUTO CUE/AUTO-ID.....	107
7-3-10. Setting the format of the playback time code.....	108
7-3-11. Setup of the playback time code frame rate.....	108
7-3-12. Setup of TC output ON/OFF in the PAUSE mode.....	108
7-3-13. Setting the TC output type in the fast winding mode.....	108
7-3-14. Selecting of event start mode by REF TC.....	108
7-3-15. Selecting the time code to be recorded.....	109
7-3-16. Selecting the CHASE operating mode.....	109
7-3-17. Selecting the lock window.....	109
7-3-18. Selecting the external clock.....	109
7-3-19. All reset of the user memory.....	110
7-3-20. Service menu.....	110

Chapter 8. Various Applications

8-1. Simple editing by connecting two D-15s.....	112
8-2. External sync driving using Digital In.....	114
8-3. Digital copy using Optical Digital In.....	115
8-4. Connection of event outputs (GPI) from an editor.....	116

Chapter 9. Specifications

Introduction

How to read this Manual

This manual is written as a guide to obtain the best results with the Fostex D-15 Digital Master Recorder. The primary features and functions, the names of each part, and operating methods important in understanding the D-15 are covered here. Furthermore, because various precautions and notes on safety, as well as, service instructions are explained in detail, we recommend that this manual be kept handy at all times.

Outline of this Manual

Reading the Table of Contents will give you a rough outline of this manual. However, the following is a brief synopsis of each chapter. Additionally, there is a brief description at the beginning of each chapter.

Chapter 1 outlines the principle and outstanding features of the D-15.

Chapter 2 gives a brief explanation regarding the names of each part, their functions and method of operation. In this chapter, we describe the D-15's front panel, display, rear panel connectors and remote controller. The chapter is arranged so that fundamental operations of the D-15 can be easily understood by those familiar with professional DAT recorders.

Chapter 3 gives specific instructions regarding installation and operation of the D-15.

Chapter 4 deals with the specifics of recording operations. Topics such as basic operation, using jog/shuttle, search/locate, and other recording techniques will be explained in detail. Read this chapter if you have questions regarding RAM SCRUB, INSTANT START, AUTO RECORD, or AUTO CUE.

Chapter 5 explains how to record and erase sub ID, as well as, the record and erase operations of S-ID, SKIP-ID, and END-ID.

Chapter 6 explains memory edit mode, storing of memory number/memory time information, and operation of recall and change.

Chapter 7, Setup mode. In this chapter, setup modes such as the D-15 initial settings are explained.

Various applications of D-15 are explained in **Chapter 8**.

Chapter 9 explains the D-15s specifications. Various specifications and physical dimensions, etc. of D-15 are also explained here.

Contents of this Manual

- * Many terms related to DAT appear in the explanations of each chapter of this manual. These special terms are expressed by the following abbreviations in the text.

A time/absolute time	A-TIME
Sampling frequency	FS
Pro R time/PRO R time	PRO R-TIME
Time code	TC
Date code	DATE
Start ID	S-ID
End ID	END-ID
Skip ID	SKIP-ID
Program number	P NO

- * As a rule, when describing the switches, keys and input/output jacks, the panel letterings itself will be used.

[Example]	
Record button	RECORD button
Blank search key	BLANK SEARCH key
Remote select switch	REMOTE switch

- * When expressing switch position names or messages appearing in the display, the panel English letterings itself will be used and enclosed by [].

[Example]	
Set the REMOTE switch to [LOCAL].	
[A-TIME] will be shown in the display.	

- * The LED indicators and operating button lamps will be expressed as "lit," "blink," and "extinguished" and messages shown in the display as "display."
- * In conventional analog recorders, it is "sound recording" but in the digital D-15, audio signal recording is referred to as "sound recording" and "record" is for various ID's.
- * In this manual, the normal operating process will be expressed as "normal display mode" and editing such as on time data as "memory edit mode."
- * In the text, the content following the [◆] mark indicates page number, item, etc. which should be referred to.
- * In the text, <NOTE> explains important points to be heeded for correct operation and handling of this recorder.

Chapter 1. Outline and Outstanding Features

The major outstanding features and functions of the Model D-15 Digital Master Recorder is explained here.

1-1. General Outline

The D-15, in addition to performing as a consumer DAT recorder, is a digital master recorder with various functions that enable it to be used as a professional recorder for use in broadcasting stations and post-production studios.

1-2. Outstanding Features

- * Because the D-15 contains 8 megabit RAM card, instant start and RAM scrub are possible.
- * High performance has been achieved by employing an 18 bit delta sigma 64 over sampling AD converter (AK5340), highly acclaimed by professionals as a reliable AD converter.
- * The DIGITAL IN of D-15 complies to both professional (IEC958 Part 3, AES/EBU) and consumer (IEC958 Part 2, S/P DIF) format digital signal.
- * External sync operation using digital signal is possible.
- * Using the GPI input/output ports, simplified editing based on A-TIME is possible with two D-15s.
- * The head of the recording can be located via headphone monitoring while muting the line out signal (audio mute).
- * Writing and erasing of S-ID, SKIP-ID, and END-ID is possible.
- * In addition to locating via S-ID and the program number, the D-15 contains a locate function using 100 memory numbers.
- * The multi-function display can show the following messages:

A-TIME

DATE

Margin level

Level indication in 0.1dB steps (indicates by alternate switching between channels)

Error rate

D-15 Owner's Manual (Chapter 1. Outline and Features)

- * The reference level can be switched in three steps of -20dB/-18dB/-12dB (initial setting: -12dB).
- * Professional self illuminating switches.
- * Record/playback of external TC, time code chase function (playback only) and external sync by VIDEO IN, WORD IN and AES/EBU IN is possible by installing the optional Model 8335 (TC/SYNC card).
In addition, control of the D-15 using the RS-422 compatible SONY 9 pin PROTOCOL is possible by installing the optional Model 8336 (RS-422 interface card: This card is to be marketed soon.).

Chapter 2. Names and Functions

The names and functions of the main unit front panel buttons, keys and switches, method of connecting the rear panel connectors, and also on the display are discussed in this chapter.

Front Panel

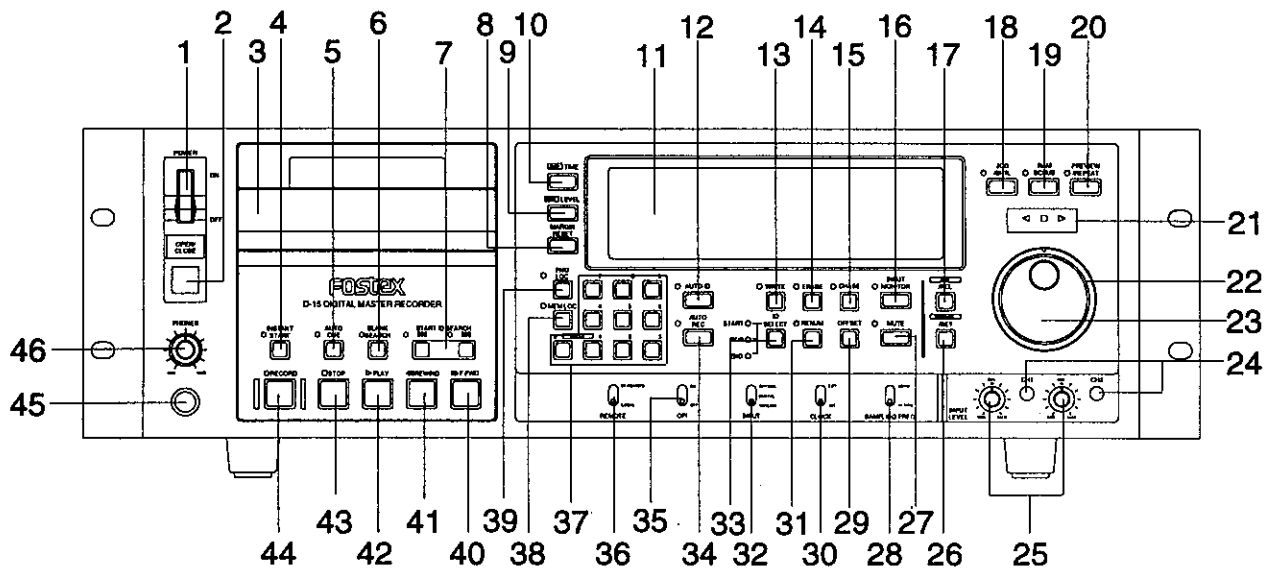

Rear Panel

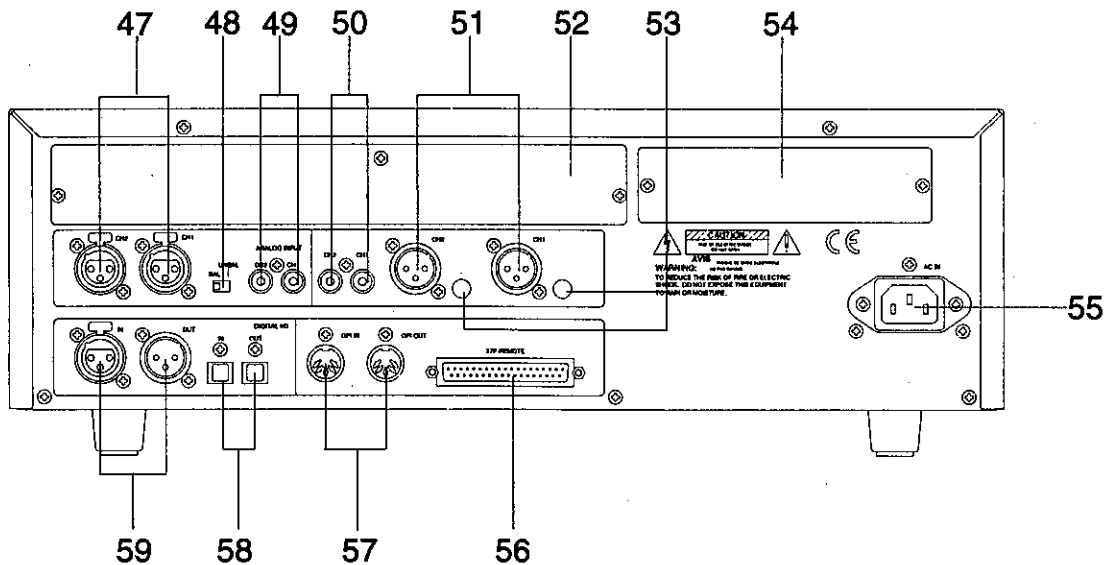

2-1. Front panel

1. [POWER] switch

Switches ON/OFF main power to D-15.

2. [OPEN/CLOSE] key

The cassette tray opens or closes with alternate pressing of this key. If the tray is closed with a cassette inserted, the tape will be loaded and the D-15 will enter the PAUSE mode.

<NOTE 1>

Open the cassette tray when in the PAUSE or STOP modes.

<NOTE 2>

If tape is loaded at the non-recorded section, it automatically enters blank search.

◆ Please refer to page [51] for details on blank search.

<NOTE 3>

When the AUTO CUE UP mode is on, if there is an S-ID at +/- 3 seconds from the point where the tape is loaded, the D-15 will enter the AUTO CUE function.

◆ Please refer to page [70] for details on the AUTO CUE mode.

Close the cassette tray in the following ways:

- 1) Press the [PLAY] button (the D-15 will PLAY after a tape is loaded).
- 2) Press the [STOP] button.
- 3) Lightly press front edge of the tray.

3. Cassette tray

A DAT cassette tape is set here.

◆ Please refer to page [39] on loading and unloading the cassette.

4. [INSTANT START] key

This key toggles the instant start mode on or off.

If the [PLAY] button is pressed when LED is lit, INSTANT START is executed. When INSTANT START mode is "ON," blinking or fast blinking of the LED indicates the following conditions.

Also, when the AUTO CUE mode is ON, switching OFF the INSTANT START mode will simultaneously switch OFF the AUTO CUE mode.

Blinking	Because audio data is being loaded into the RAM, wait until it changes to constant lighting before carrying out the next operation.
Fast blinking	Instant start cannot be executed because A-Time/R-Time are not written on the tape.
Lighting	Input of AUDIO DATA into RAM is completed and INSTANT START can be executed.

5. AUTO CUE key

ON/OFF of the AUTO CUE mode is toggled by this key.

If AUTO CUE mode is ON, the D-15 enters the INSTANT START mode.

◆ Please refer to page [70] for details on the AUTO CUE mode.

6. [BLANK SEARCH] key

The tape's unrecorded section is found by pressing this key. If END-ID (Note) is recorded on the tape, it will pause at two seconds before the END-ID. The LED will be lit during execution and extinguish at completion.

<NOTE>
 Unrecorded sections less than 9 seconds long cannot be searched in some cases.

◆ Please refer to page [51] for details on blank search.

7. [START ID SEARCH] << >> key

<< key	<p>S-ID search is executed in the REWIND direction for the number of times this key is pressed. After completing the search, it will pause at a point about one second before the objective S-ID.</p> <p>The LED will be lit during execution and be extinguished upon completion. Search at INSTANT START will PAUSE at the head of an S-ID.</p>
>> key	<p>S-ID search is executed in the FORWARD direction for the number of times this key is pressed. After completing the search, it will pause at a point about one second before the objective S-ID.</p> <p>The LED will be lit during execution and be extinguished upon completion. Search at INSTANT START will PAUSE at the head of an S-ID.</p>

** If search is executed while in auto cue up mode, the recorder will accurately locate to the sound rise up point in the vicinity of the S-ID.*

** If the [PLAY] key is pressed during search, PLAY is entered upon ending search. In this case, INSTANT START will not be executed.*

◆ Please refer to page [60] for details on S-ID search.
 ◆ Please refer to page [70] for details AUTO CUE mode.

8. [MARGIN RESET] key

If this key is pressed while the margin level is displayed, the margin level will be reset.

9. [DISP LEVEL] (level display) selector key

The level indication on the display will cyclically switch with each press of this key as follows:

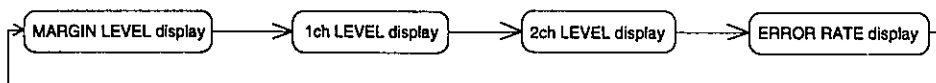

The recorder will return to any one of the above displays if this key is pressed while [NEXT] is on display.

◆ Please refer to page [24] for details on the [NEXT] display.

10. [DISP TIME] (time display) selector key

Normal display modes are switched with each press of this key as follows:

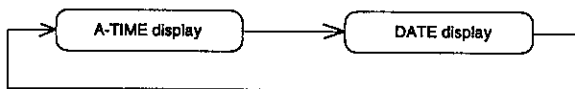

The recorder will return to the normal display mode if this key is pressed when in memory edit mode.

◆ Please refer to page [23] explanations on the memory edit mode/normal edit mode.

11. Display

Time information and audio signal level and the content of various settings will be displayed.

◆ Please refer to page [23] for details.

12. [AUTO-ID] key

The AUTO-ID mode is alternately switched ON/OFF by pressing this key. In the AUTO-ID mode, an S-ID is automatically recorded at the instant a signal larger than the standard level (*) is input after the start of recording and elapse of more than a certain length of time (*) of no-sound recording. In this case, if a P NO is already shown in the [PGM NO] display at the point where recording is started, it will automatically count up from this P NO and record it.

If any number (001~799) is input with the numerical keypad, the D-15 will automatically count up from this number and record the S-ID.

(*) Initial setting of no sound time is "900msec." and the reference level "-40dB." These settings can be changed by the SETUP mode.

◆ Please refer to page [73] for details on recording of S-ID/P-NO.
 ◆ Please refer to page [95] for details on the SETUP mode.

< NOTE OF CAUTION >
 Because the D-15 is a two head type recorder, be extremely careful not to record/erase sub ID's or execute renumbering because sub code information recorded up to that point will be re-written.

13. [WRITE] key

This key is used when recording the SUB ID (any one from among S-ID/SKIP ID/END-ID) selected by the [ID SELECT] key or at renumbering the P NO.

If this key is pressed when recording a SUB ID selected by the [ID SELECT] key, the SUB ID will be recorded in real time at the point where the key was pressed.

Also, if this is pressed during playback, WRITE LED will blink, RAM REHEARSAL will be carried out and, after adjusting the recording point with the [JOG] dial, this key can be pressed again to record it.

Also, P NO will be renumbered if this key is pressed when the [RENUM] key LED is lit. Lighting or blinking of the [WRITE] key LED indicates the following conditions:

Blinking	The recorder is executing WRITE rehearsal of S-ID, SKIP-ID or END-ID.
Lighting	The D-15 is executing WRITE or renumbering of S-ID, SKIP-ID or END-ID. This LED will extinguish at the end of execution.

◆ Please refer to page [73] for details on recording of Sub ID's.

<NOTE>

Recording of Sub ID's cannot be executed if A-TIME is not recorded on the tape or it is in the INSTANT START mode.

< NOTE OF CAUTION >

Because the D-15 is a two head type recorder, be extremely careful not to record/erase sub ID's or execute renumbering because sub code information recorded up to that point will be re-written.

14. [ERASE] key

This key is used to erase the sub ID (any one from among S-ID, SKIP-ID and END-ID) selected by the [ID SELECT] key. When in the PAUSE or STOP mode, if this key is pressed with any one of the ID SELECT LED in the lighted state (READY mode), an S-ID/Skip-ID located within 9 seconds beforehand of the point where this key had been pressed can be erased. The LED will be lit during execution and be extinguished at end of execution.

◆ Please refer to page [73] for details on erase of S-ID, SKIP-ID and END-ID.

< NOTE OF CAUTION >

Because the D-15 is a two head type recorder, be extremely careful not to record/erase sub ID's or execute renumbering because sub code information recorded up to that point will be re-written.

15. [CHASE] key

This key will be functional when the optional Model 8335 (TC/SYNC card) is installed in the D-15. If this card is not installed, there will be no reaction when this key is pressed.

◆ Please refer to the Model 8335 Owners Manual on the CHASE key operation.

16. [INPUT MONITOR] key

When this key is pressed, the D-15 will alternately switch between input monitor and repro monitor. The presently selected monitor is indicated as below by the LED:

Lighting	Input monitoring is possible. (Refer to <NOTE> below.)
Slow Blinking	Indicates the recorder is in automatic input monitor when in the recording and rehearsal modes.
Fast Blinking	This indicates that it cannot "input monitor" as it is playing back in the INSTANT START mode and that it is in the process of loading audio data into the RAM. (Refer to <NOTE> below.)
Extinguished	Input cannot be monitored by the repro monitor.

<NOTE>

1. During playback of RAM:

During playback of RAM by the PLAY button and JOG/SHUTTLE dial in the RAM SCRUB and RAM PREVIEW/RAM REPEAT modes, it will not be in input monitoring but be in repro monitoring even though the LED is lit. If playback of RAM is stopped by STOP or PAUSE, the D-15 will be in the input monitor mode.

2. During writing of AUDIO DATA in the RAM:

During writing of AUDIO DATA into the RAM, respectively in the INSTANT START or RAM SCRUB modes, input monitoring will be interrupted but will return to input monitoring upon completion of the read out.

17. [QUIT/RCL] (recall) key

This key has the following two functions:

First, it is used to enter the "Data Edit Mode" to recall various time information for the purpose of memory data editing and DATE editing (edit of internal clock).

Secondly, it is used to interrupt editing to return to the original display from the data editing mode. In the SETUP mode, it is also used to interrupt setup changing or to escape from the SETUP mode (quit).

- ◆ Please refer to page [89] for details on memory data editing.
- ◆ Please refer to page [41] for details on DATE editing.
- ◆ Please refer to page [95] for details on SETUP mode.

18. [JOG/SHTL] (jog/shuttle) key

During normal operation, the LED is lit when this key is pressed once and the JOG/SHTL mode will be "ON."

In the JOG/SHTL mode, playback in JOG SPEED of 1/2 ~ 2 times speed by manipulating the [JOG] dial, and the SHUTTLE SPEED of 1/2 ~ 15 times speed by manipulating the [SHUTTLE] dial, is possible.

To cancel (OFF) the JOG/SHTL mode, press any other transport key such as STOP.

<NOTE>
RAM is not used in the JOG/SHTL mode, and the tape signal is read in real time.

19. [RAM SCRUB] key

If this key is pressed once, the RAM SCRUB mode will be "ON" and the LED will change from blinking to lit. In the RAM SCRUB mode, RAM playback is possible in JOG/SHUTTLE SPEED at 0 ~ 1 times speed with the [JOG] dial or [SHUTTLE] dial. When the RAM SCRUB mode is "ON," the LED indication content are as follows.

Blinking	AUDIO DATA is being written into the RAM, RAM SCRUB in standby.
Lit	RAM SCRUB standby or in execution.

<Outstanding Features of RAM SCRUB>

By operating the [JOG] dial, cueing is possible to an accuracy of less than a frame at one time playback speed.

By operating the [SHUTTLE] dial, playback speed will change in accordance to the dial position (rotating angle) thus making cueing possible as it is in conventional analog recorders.

In the RAM SCRUB mode, RAM SCRUB is carried out within the +/- 1.5sec. range centered around the point where the key was pressed.

<NOTE>
If the LED is blinking, always wait until the LED changes to constant lighting before going to the next operation in order to prevent misoperation.

- ◆ Please refer to pages [55, 59, 66, 67, 68] for operating procedures on RAM SCRUB.

20. [PREVIEW/REPEAT] key

If this key is pressed in the INSTANT START mode, it enters the PREVIEW mode, execute 3 seconds of RAM REHEARSAL playback once (LED is lit), then cancel the PREVIEW mode (LED is extinguished).

If this key is pressed again during RAM REHEARSAL playback in the PREVIEW mode, it enters the REPEAT mode and continue repeating one second RAM REHEARSAL playback (LED blinks during this mode).

Press the [STOP] or other tape handling buttons to cancel the REPEAT mode. If this key is pressed while in the AUTO REC mode, rehearsal of AUTO REC can be executed.

- ◆ Please refer to pages [54, 67, 68] for operating procedures on PREVIEW/REPEAT.
- ◆ Please refer to page [52] for details on AUTO REC.

21. [JOG/SHTL] (jog/shuttle) lamp

The indicating lamps when lit indicates the D-15 operation as listed below.

> lamp	Lit when cueing in the REWIND direction.
□ lamp	Lit when the transport or RAM playback is in PAUSE.
< lamp	Lit when cueing in the FORWARD direction.

22. [SHUTTLE] dial

[SHUTTLE] is possible in the JOG/SHTL mode and RAM SCRUB mode. Also, any digit to be edited can be moved during data editing.

- ◆ Please refer to pages [54 - 68] for details on JOG/SHTL and RAM SCRUB mode.

23. [JOG] dial

[JOG] operation is possible in the JOG/SHTL mode and RAM SCRUB mode. While in the REPEAT mode, the RAM REHEARSAL START point can be moved. In addition, UP/DOWN input of numbers in the data edit mode is possible and the setup menu can be selected in the SETUP mode.

- ◆ Please refer to pages [54 - 68] for details on JOG/SHTL and RAM SCRUB modes.
- ◆ Please refer to page [89] for details on data edit and page [95] for the SETUP mode.

24. Standard recording level control trimmer

This trimmers controls standard recording level (INPUT LEVEL knob's "CAL" position) of the analog audio input signals.

25. INPUT LEVEL knob

This controls input level of the analog audio signals (Ch1, Ch2). The knob center click (CAL position) is the standard recording level.

- ◆ Please refer to page [48] for details.

26. [EXECUTE/SET] key

This key has two functions.

One, it is used to register (set) data in on-the-fly or data edit modes (including DATE editing).

Two, it is used at various setups in the SETUP mode or fixing (execute) of the SETUP data.

- ◆ Please refer to page [89] for details on the memory data editing.
- ◆ Please refer to page [41] for details on DATE editing.
- ◆ Please refer to page [95] for details on the SETUP mode.

27. [MUTE] key

RECORD MUTE is executed and a no sound recording made by pressing this key while in the record mode. Also, if it is pressed during playback, ANALOG output and AES/EBU output will be muted but the headphone output and S/P DIF output will not be muted (this can be utilized at cueing with the headphone).

- ◆ Please refer to page [50] for details on REC MUTE.

28. [SAMPLING FREQ](sampling frequency) selector switch

[Using the ANALOG input]

FS (44.1kHz/48kHz) at recording is set here.

In playback, it is automatically set to the tape FS. If the switch setting is different from the tape FS, the [44.1kHz] or [48kHz] in the display will blink.

[Using the DIGITAL input]

At DIGITAL INPUT (for both AES/EBU and S/P DIF), set FS to the same one as that in the digital signal that is being input.

If the setting is different, the display [DIGITAL IN] will blink.

During playback, it will be automatically set to the tape FS and played back but if FS between the input digital signal and the tape is different, the display [44.1kHz] or [48kHz] will blink.

To prevent mixing the FS on the tape, FS of the input digital signal and that on the tape must always be matched.

29. [OFFSET] key

This key will be functional when the optional Model 8335 (TC/SYNC card) is installed in the D-15.

If this card is not installed, there will be no reaction when this key is pressed.

- ◆ Please refer to the Model 8335 Owners Manual on the OFFSET key operation.

30. [CLOCK] switch

The D-15 driving clock can be selected to internal clock (INT) or external sync (EXT) with this switch.

The [INT] position is normally used but when an optional Model 8335 (TC/SYNC card) is installed in the D-15 and externally synchronized by external WORD, VIDEO, and AES/EBU, this switch is set to the [EXT] position. The external clock for this is selected by the D-15 SETUP mode.

- ◆ Please refer to the Model 8335 Owners Manual for using in the "EXT" position.
- ◆ Please refer to the Model 8335 Owners Manual for details on the SETUP mode.

31. [RENUM] (renumber) key

This key functions as the READY key for executing renumbering of P NOs. Renumbering is executed by switching this key ON (RENUM LED is lit) and then pressing the [WRITE] key.

- ◆ Please refer to page [79] for details on P-NO renumbering.

32. [INPUT] selector switch

This selects whether input to this recorder will be digital (AES/EBU format), optical (S/P DIF format), or analog.

[External sync by DIGITAL IN]

When this switch is set to DIGITAL or OPTICAL, it will be possible to externally sync (internal clock of D-15 is synchronized with an external digital clock) with a digital signal.

When a D-15 without a Model 8335 installed is to be externally synchronized with a digital signal, the [CLOCK] switch must be set to [INT]. In this case, the setup digital signal only can be recorded.

[DIGITAL]

This selects the input signal applied to the XLR-3 connector in the rear panel digital input section. Upon locking onto the input, [DIGITAL IN] on the display will be lit.

[OPTICAL]

This selects the input signal applied to the [OPTICAL] connector in the rear panel digital input section. Upon locking onto the input, [DIGITAL IN] on the display will light.

[ANALOG]

This selects the input signal applied to the XLR-3 connector (balanced) or the RCA connector (unbalanced) in the rear panel ANALOG INPUT section (input at the connectors is switched by the rear panel [BAL-UNBAL] selector).

<NOTE 1>

When this switch is set to [DIGITAL] or [OPTICAL] and the [DIGITAL IN] display blinks, the following cause can be assumed:

- A. The FS of the input digital signal and that set in the D-15 is different. In such a case, reset the [SAMPLING FREQ] selector switch.
- B. There is no input of a digital signal. Or, a digital signal which cannot be locked is being input. In this case, check the cable and connections or the digital equipment output state.

<NOTE 2>

When this switch is set to [ANALOG], if the rear panel [BAL/UNBAL] selector switch setting is incorrect, an analog signal will not be input. If an XLR-3 connector is to be used, it must be set to [BAL] and for a RCA jack, it must be set to [UNBAL].

33. [ID SELECT] key

A Sub ID (S-ID, SKIP-ID, END-ID) to be recorded or erased is selected and entered in the READY state for sub ID record/erase by this key.

With each press of this key, [OFF] -> [START] -> [SKIP] -> [END] -> [OFF] is repeated and LED of the selected sub ID is lit.

To execute record/erase of the sub ID after selecting with this key, press either the [WRITE] key or [ERASE] key.

◆ Please refer to page [73] for details on record/erase of sub ID's.

34. [AUTO REC] mode key

ON/OFF of the AUTO REC mode alternates with each press of this key.

Auto record is a function of automatic recording (auto punch in/out) between "memory [00]" and "memory [01]" of A-Time.

For execution of AUTO REC, A-TIME must definitely be recorded at the memory [00] point.

In the auto record mode, rehearsal is executed by pressing the [PREVIEW/REPEAT] key, and AUTO REC executed by pressing the [RECORD] button.

These operating conditions are indicated as follows by the LED:

Lit	The D-15 is executing AUTO REC.
Blinking	When set to AUTO REC mode and during rehearsal.

<NOTE 1>

Normal recording cannot be done when the D-15 is in the AUTO REC mode.

<NOTE 2>

If A-TIME is not recorded on the tape, record about 30 seconds of A-TIME in the normal recording mode.

<NOTE 3>

AUTO REC can be executed even though nothing is set in "memory [01]" but be sure its contents is "00:00:00:00."

◆ Please refer to page [52] for details on AUTO REC.

35. [GPI] (GPI) ON/OFF switch

This switches on or off the GPI input/output at the rear panel GPI connector. This switch is effective regardless to which position the [REMOTE] selector is set.

◆ Please refer to "GPI connector" in page [29] for details on GPI input/output.

36. [REMOTE] selector switch

This selects from where this recorder will be controlled.

[9 PIN REMOTE]

This position is selected when the optional Model 8336 (RS-422 interface card is to be marketed soon) is installed in the D-15 and controlled by the 9 PIN REMOTE contained in Model 8336. Selecting panel lock when using it in this mode is separately done in the SETUP mode.

If this mode is entered without the Model 8336 installed, the D-15 will be in normal panel lock and although the main unit tape transport buttons will not function, the [DISP TIME] key, [DISP LEVEL] key and the [OPEN/CLOSE] key will be operational.

[LOCAL]

Control is possible via the front panel.

◆ Please refer to page [95] for the SETUP mode.

37. Numerical keypad

Direct input to the edit point is possible when display is in the memory edit mode. If the desired number is input from the [numerical keypad] when in the normal display mode, it will change to the [NEXT] display and, at the same time, this number will be displayed. Locate operation and recording of S-ID/P NO can be done based on this number. In addition, it will enter the setup mode when the numerical keypad "0" and "1" are simultaneously pressed.

◆ Please refer to pages [53-56, 62-64, 78, 89] on using the numerical keypad.
◆ Please refer to page [95] for details on the SETUP mode.

38. [MEM LOC] (Memory Locate) key

When this key is pressed, it will locate to the previously set memory number. The LED will be lit during execution of locate and be extinguished at completion. If the key is pressed after specifying memory number 00~99 from the numerical keypad in the [NEXT] display, the D-15 will locate to the specified memory number. If the key is pressed without specifying the memory number, the D-15 will locate to memory "[00]."

** If the [PLAY] button is pressed during lighting, the D-15 will automatically enter playback upon completing locating. In this case, INSTANT START will not be executed.*

<NOTE 1>

Normally, the D-15 will locate to approximately one second before a P NO. But, in INSTANT START mode, the D-15 will locate to head of the P NO.

<NOTE 2>

If a DATE is shown in the display, locate will not be executed.

<NOTE 3>

If this key is pressed in the memory edit mode, it will directly locate to the edited time.

◆ Please refer to page [63] for details on locating of the memory number.
◆ Please refer to page [89] for details on setup of the memory number.

39. [PNO LOC] (Program Number Locate) key

When this key is pressed, the D-15 will locate to the S-ID recorded on the tape. The LED will be lit during locate and extinguish upon completion. If this key is pressed after input of a random P NO by the numerical keypad in the [NEXT] display, it will locate to the specified P NO. If this key is pressed while a P NO is displayed in the present [PGM NO], the D-15 will locate to that P NO.

<NOTE 1>

Normally, the D-15 will locate to approximately one second before a P NO. But, in INSTANT START mode, the D-15 will locate to head of the P NO.

<NOTE-2>

If a DATE is shown in the display, locate will not be executed.

* If [PLAY] button is pressed during PLAY, playback is automatically entered upon completion of locating.

◆ Please refer to page [62] for details on locate by P NO.

40. [F FWD] (fast forward) button

When this button is pressed once, the D-15 will enter five times normal speed and the [PLAY] button and this button will light.

If this is pressed again, the recorder will enter fast forward at high speed and the [F FWD] button only will be lit. The D-15 will alternate between five times speed and high speed with each press of this button.

41. [REWIND] button

The recorder enters five times normal speed at rewind and the [PLAY] button lamp and this button lamp will be lit.

If this is pressed again, the D-15 rewinds at high speed and the [REWIND] button only will light. The D-15 alternates between five times speed and high speed with each press of this button.

42. [PLAY] button

In normal operation, when this button is pressed, the lamp will light and the tape will start traveling. If this button is pressed during locate/search, the recorder will enter locate (search) and play, and then enter play after locating or completing the search.

To start recording, simultaneously press this with the [RECORD] button.

Furthermore, if this button is pressed during the record mode, the D-15 will punch out and return to play.

Also, if this button is pressed during INSTANT START mode, the recorder will execute INSTANT START.

If the cassette tray is open, pressing this button will close it. If a cassette is in the tray, the tape will be loaded and the recorder will enter play mode.

<NOTE>

When this button is pressed even though the [INSTANT START] key LED is blinking, INSTANT START cannot be executed and the recorder will be in normal playback.

43. [STOP] button

During normal operation, the D-15 enters pause when this button is pressed once, the [STOP] button lamp is lit and the [PLAY] button lamp will blink. If this button is pressed again, the recorder enters stop mode and the [STOP] button lamp only will be lit. Also, when the cassette tray is open, it can be closed by pressing this button.

<NOTE>

The D-15 will not stop if it is loading into the RAM in INSTANT START mode.

44. [RECORD] button

Recording is started by simultaneously pressing this button together with the [PLAY] button. Auto record is entered by pressing this button only in the auto record mode.

<NOTE 1>

RECORD will not operate in the INSTANT START mode. If this is mistakenly selected, the [RECORD] and [PLAY] buttons will fast blink a warning.

<NOTE 2>

Recording cannot be done if the cassette erase protection hole is open.

- ◆ Please refer to page [39] for details on the cassette erase protection hole.
- ◆ Please refer to page [44-] for details on the RECORD button.
- ◆ Please refer to page [52] on the AUTO REC mode.

45. [PHONES] jack

Plug in the headphone here.
Permissible load impedance is 8 ohm to 50 ohm.

46. [PHONES] knob

Controls the headphone monitor level.

[1CH] level display

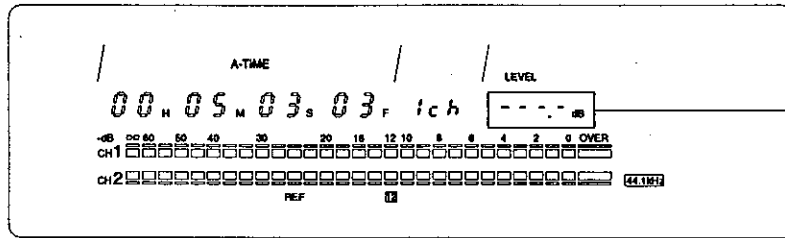

Displayed 1 channel level

[2CH] level display

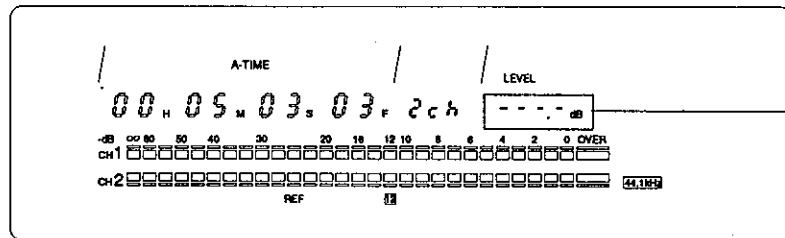

Displayed 2 channel level

[ERROR RATE] display

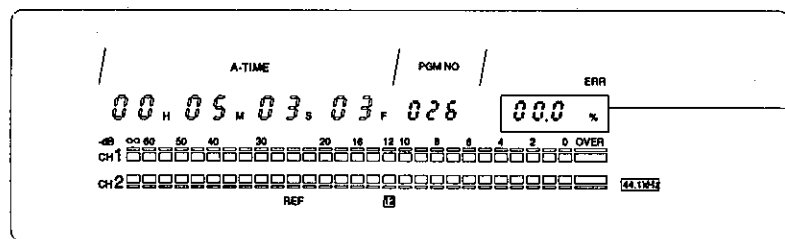

Displayed error level

Display of the edit mode

In the case of [A-TIME] display.

[NEXT] display

If a random number is input with the numerical keypad, [NEXT] is automatically displayed and simultaneously with the display of the input number, the [NEXT] section will blink (Example: When "2" is input from the numerical keypad). This function is used to record P NO locate, memory locate, and P NO.

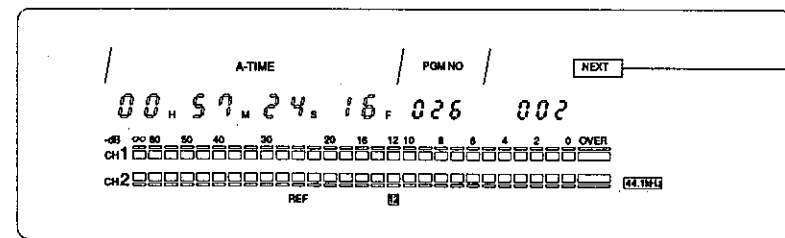

Blink

[MEMORY] display

If the [QUIT/RCL] key is pressed while [NEXT] is on display, it will change to data edit of the memory number specified by the numerical keypad. If the [QUIT/RCL] key is pressed without any input from the [numerical keypad], the display will be for data edit of memory number "0" (Example: If the [QUIT/RCL] key is pressed after input of "2" from the [numerical keypad], it will be possible to edit data stored in the [NEXT] display "02" ("H" will blink).

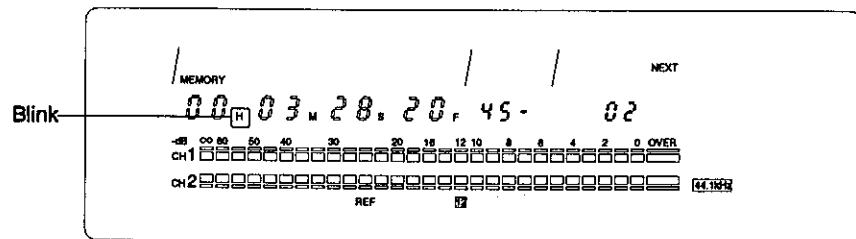

The case of [DATE] display

[DATE] edit mode display

If the [QUIT/RCL] key is pressed with [DATE] displayed, it will be DATE memory edit and it will be possible to edit the internal clock ("Y" will blink).

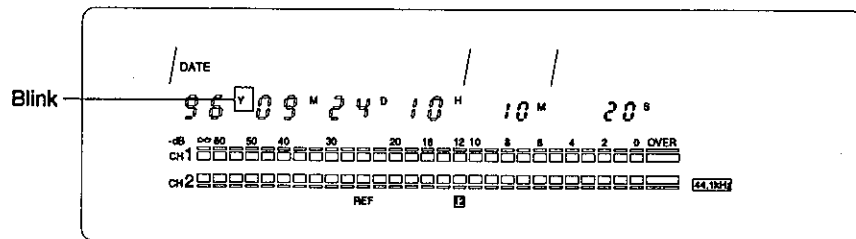

The SETUP mode display

This will change to the next display when the [numerical keypad] "0" and "1" are simultaneously pressed and the SETUP mode is entered.

There are various setup items in the SETUP mode for the most convenient operation of the D-15 depending on its specific use. (Example: The display mode for confirming the ROM version).

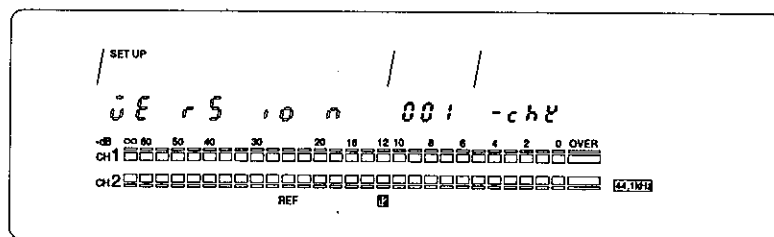

The Preset Display

There are the following preset display items of the D-15 display which will light or blink when D-15 is in the conditions listed below.

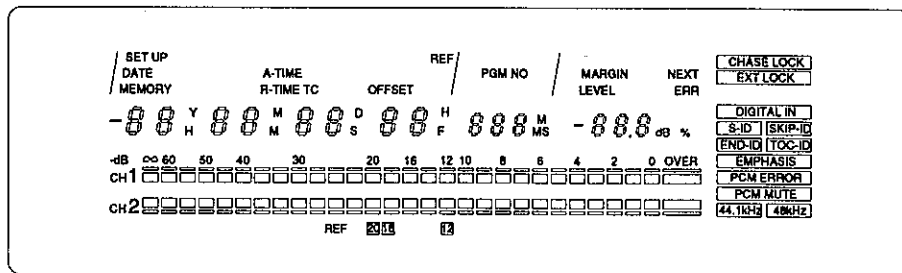

[DIGITAL IN]

This is lit when the INPUT selector switch is set to [DIGITAL] or [OPTICAL], and when locked to the digital signal.

[S-ID]

Indicates an S-ID on the tape. This is also lit during recording of an S-ID.

[SKIP-ID]

Indicates a Skip-ID on the tape. This is also lit during recording of a Skip-ID.

[END-ID]

Indicates an END-ID on the tape. This is also lit during recording of an END-ID.

[TOC-ID]

Displays TOC-ID on the tape.

[EMPHASIS]

If this blinks during digital input, it indicates the emphasis information on the tape is not matched with emphasis information from the digital input. In either case, emphasis on the tape is automatically set when in other than record and input monitor.

[44.1kHz / 48kHz]

This indicates the frequency sampling in operation.

When the recorder is set to analog input, the frequency sampling information on the tape will be given priority when in anything other than the record mode, and is automatically set to frequency sampling from the tape information. However, in the record mode, it will be changed according to the frequency sampling switch setting.

On the other hand, this will blink if the frequency sampling information on the tape is different from the switch setting. When the tape is ejected, the frequency sampling is determined by the switch setting.

When using digital input, frequency sampling information on the tape is given priority over the frequency sampling information in the digital input and frequency sampling set by the switch will be irrelevant.

If there is a difference in sampling frequency between the switch and tape, the tape sound will be played back but the sampling frequency display will blink.

REF [20] [18] [12]

The reference level of the D-15 will be displayed.

As shipped from the plant, the initial reference level is set to -12dB.

This reference level can be changed by the D-15 SETUP mode.

For details on this, please refer to page [100] SETUP mode "rE F L VL 102."

[CHASE LOCK]

This display will function when the optional Model 8335 (TC/SYNC card) is installed in the D-15 (Refer to the Model 8335 Owners Manual for details).

[EXT CLOCK]

This display will function when the optional Model 8335 (TC/SYNC card) is installed in D-15. If the CLOCK switch is mistakenly set to "EXT" without a Model 8335 installed, this will blink as warning (Refer to the Model 8335 Owners Manual for details).

[PCM ERROR]

This will be extinguished during normal playback but is lit when a block error rate of more than ten percent occurs.

[PCM MUTE]

This is lit when there are many errors and the signal is muted but when playback is normal, it will be extinguished. This will be lit immediately after start of playback and until the tape speed becomes stable but this is not a malfunction.

2-3. Rear panel

47. ANALOG INPUT connector (balanced)

Analog audio signals from CH1(L), CH2(R) are input.

Connector: XLR-3-31 type (#2 pin hot)

Standard input level: +4dBu

48. BAL/UNBAL (balanced/unbalanced) selector switch

This selects the input connector.

BAL : Selects the XLR-3-31 type connector.

UNBAL: Selects the RCA pin jack.

49. ANALOG INPUT connector (unbalanced)

Analog audio signals from CH1(L), CH2(R) are input here.

Connector: RCA pin jack

Standard input level: -10dBV

50. ANALOG OUTPUT connector (unbalanced)

Analog audio signals from CH1(L), CH2(R) are output here.

Connector: RCA pin jack

Standard output level: -10dBV

51. ANALOG OUTPUT connector (balanced)

Analog audio signals from CH1(L), CH2(R) are output here.

Connector: XLR-3-32 type (#2 pin hot)

Standard output level: +4dBu

52. Option Panel A

This is the panel for adding the optional Model 8335 (TC/SYNC card).

Do not remove the blank panel if the option is not used.

53. Output standard level adjusting trimmer

Standard level of the analog audio outputs (CH 1, CH 2) are adjusted by this trimmer.

<NOTE>

Outputs of the balanced/unbalanced lines will both be changed by this trimmer.

54. Option panel B

This is the panel for adding the optional Model 8336 (RS-422 interface card: To be marketed soon). Do not remove the blank panel if the option is not used.

55. Power Line connector

Connect this exclusive power line cable included with D-15 to a wall socket or power outlet.

56. 37 pin REMOTE connector

Connector: D-SUB 37 pin.

The connector for the 37 pin parallel remote signal.

◆ Please refer to page [31] for details on the connector pin assignments, etc.

57. GPI input/output connectors

These connectors will function when the front panel GPI switch is set to on.

[GPI IN] connector (Connector: DIN 5 pin)

This will function as shown below when a TTL level LOW active signal is input.

STOP command input (Pin #2)

Function equal to the STOP button is achieved by input of  pulse.

PLAY command input (Pin #3)

Function equal to the PLAY button is achieved by input of  pulse.

<NOTE 1>

In the INSTANT START mode and also when the STOP command (Pin #2) is LOW level, if a PLAY command is input, the recorder will enter INSTANT START rehearsal (PREVIEW).

ID SEARCH >> command input (Pin #4)

Function equal to the ID SEARCH >> key is achieved by input of  pulse.

ID SEARCH << command input (Pin #5)

Function equal to the ID SEARCH << key is achieved by input of  pulse.

<NOTE 2>

Command input level is specified to TTL level-LOW ACTIVE. Therefore, do not use this by other than TTL level because it could result in malfunction or breakdown.

** Minimum input pulse width: 15msec.*

[GPI OUT] connector (Connector: DIN 5 pin)

Event signal is output at playback/record.

EVENT 1 output (Pin #2)

An approximately 30msec. event signal is output to the memory "1" time at play or record.

EVENT 0 output (Pin #3)

An approximately 30msec. event signal is output to the memory "0" time at play or record.

<NOTE 1>

When A-TIME is displayed, the recorder will output the time for A-TIME but if the optional Model 8335 (TC/SYNC card) is installed, it can also output in time for TC.

<NOTE 2>

Output is OPEN COLLECTOR.

When connecting external equipment, use pull up resistors of 1K ohm or higher. Do not use pull up resistors with a value less than 1K ohm because it can result in a breakdown.

Please refer to page [111], "Chapter 8 Various applications" for practical application examples.

58. Digital Input and Output connectors (S/P DIF)

[DIGITAL INPUT] connector (optical)

Connector: Optical connector

IEC958 Part 2 (S/P DIF) format digital audio signals are input here.

[DIGITAL OUTPUT] connector (optical)

Connector: Optical connector

IEC958 Part 2 (S/P DIF) format digital audio signals are output here.

<NOTE 1>

If the IEC958 Part 2 (S/P DIF) format is used, dubbing is possible while copying an S-ID.

<NOTE 2>

Digital output [OPTICAL] is output without passing through the RAM. Therefore, for digital output via RAM such as with instant start and RAM scrub, the digital output [AES/EBU] must be used.

59. Digital Input and Output connectors (AES/EBU)

[DIGITAL INPUT] connector (AES/EBU)

Connector: XLR-3-31 type (#2 pin hot)

IEC958 Part 3 (AES/EBU) format digital audio signals are input here.

[DIGITAL OUTPUT] connector (AES/EBU)

Connector: XLR-3-32 type (#2 pin hot)

IEC958 Part 3 (AES/EBU) format digital audio signals are output here.

GPI IN/OUT connector pin assignment

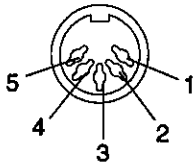

GPI IN		GPI OUT	
1	GND	1	GND
2	STOP	2	EVENT 1
3	PLAY	3	EVENT 0
4	S-ID SEARCH >>	4	NO CONNECTED
5	S-ID SEARCH <<	5	NO CONNECTED

37P-REMOTE connector pin assignment

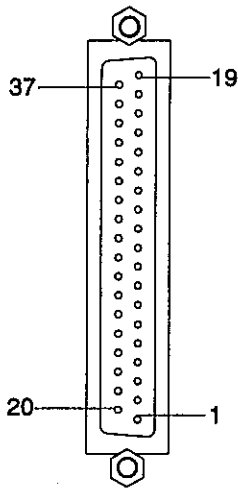

PIN	Signal		PIN	Signal	
1	GND		20	GND	
2	STOP STATUS	OUT	21	STOP COMMAND	IN
3	FF STATUS	OUT	22	FF COMMAND	IN
4	PLAY STATUS	OUT	23	PLAY COMMAND	IN
5	REW STATUS	OUT	24	REW COMMAND	IN
6	STANDBY STATUS	OUT	25	STANDBY COMMAND	IN
7	INPUT MON STATUS	OUT	26	INPUT MON COMMAND	IN
8	REC STATUS	OUT	27	REC COMMAND	IN
9	ID SEARCH STATUS	OUT	28	ID SEARCH COMMAND	IN
10	RAM SCRUB STATUS	OUT	29	ID PREVIOUS COMMAND	IN
11	S-ID STATUS	OUT	30	S-ID WRITE COMMAND	IN
12	SKIP-ID STATUS	OUT	31	SKIP-ID WRITE COMMAND	IN
13	END-ID STATUS	OUT	32	END-ID WRITE COMMAND	IN
14	CHASE STATUS	OUT	33	CHASE COMMAND	IN
15	REVERSE COMMAND	IN	34	RAM SCRUB COMMAND	IN
16	TAPE SPEED A COMMAND	IN	35	NC	
17	TAPE SPEED B COMMAND	IN	36	RESERVE	
18	SERVO LOCK ON STATUS	OUT	37	RESERVE	
19	+5V				

Input : PNP transistor input, LOW active (Pulse width more than 30msec)

Output : Open collector (+5V, 10k ohm, pull up)

+5V output : Max. 100mA (Signals in Pin No. 15, 16, 17 are not pulses but HIGH or LOW state signals)

D-15 Owner's Manual (Chapter 2 Names and Functions)

Signal	Functions	
	Command	Status
STOP	Stops tape transport.	The status of the D-15 is indicated by a combination of one or two status.
FF	Winds the tape forward at high speed.	
PLAY	Plays back the tape.	
REW	Winds the teape in reverse at high speed.	
REC	Records on the tape by simultaneous output of REC and PLAY commands.	
STANDBY	Can be switched between STANDBY (pause) /OFF (stop).	
SERVO LOCK		Status for indicating condition of servo lock or chase lock.
INPUT MONITOR	Audio output source can be switched (toggle).	Tape playback signal if status is Hi and input audio signal if status is Lo.
ID SEARCH (NEXT)	Locates to next S-ID and stops. Progressively locates to farther S-ID for number of times pressed and stops.	Status output indicating locate condition. This will indicate the status of both ID-Locate and Time Code-Locate. In this case, the fast forward status is output for the ID-NEXT signal and the rewind status for ID-PREVIOUS signal.
ID SEARCH (PREVIOUS)	Locates to previous S-ID and stops. Progressively locates to previous S-ID for number pressed and stops.	
START-ID	Command for recording S-ID.	ID detecting status.
SKIP-ID	Command for recording SKIP-ID.	ID detecting status.
END-ID	Command for recording END-ID.	ID detecting status.
CHASE	Switches ON the chase function contained in D-15.	Status of chase ON.
REVERSE TAPE SPEED A TAPE SPEED B	Enters tape or RAM shuttle operation. For playback speed, refer to "Control of tape/RAM playback speed".	Outputs STOP + FF or STOP + REW.
RAM SCRUB	Sound on tape is located in the RAM. For RAM playback speed, refer to "Control of tape/RAM playback speed".	When the RAM scrub status is ON, sound will be played back from the REVERSE and TAPE SPEED A/B commands.

Controll of tape/RAM playback speed

The tape speed and RAM playback speed can be changed as shown in the chart below by various combinations of TAPE SPEED A/B cpmmand signal from pins numbered 15, 16 and 17 of the 37 PIN REMOTE connector.

Normal operation (Pin No. 10 RAM SCRUB STATUS: HI)

No.15	No. 16	No. 17	TAPE SPEED
-	H	H	STILL
H	H	L	x 1
H	L	H	x 3
H	L	L	x 16
L	H	L	x -1
L	L	H	x -3
L	L	L	x -16

RAM SCRUB operation (Pin No. 10 RAM SCRUB STATUS: Lo)

No.15	No. 16	No. 17	RAM PLAYBACK SPEED
-	H	H	STILL (*)
H	H	L	x 1/8
H	L	H	x 1/2
H	L	L	x 1
L	H	L	x -1/8
L	L	H	x -1/2
L	L	L	x -1

Chapter 3. Preliminary Notes

This Chapter explains precautions to be followed before operating the D-15, important DAT techniques which should be understood and the internal clock function.

Chapter 3. Table of Contents

3-1. Precautions in operation.....	34
3-1-1. Precautions for installation.....	34
3-1-2. Precautions on dewing.....	34
3-1-3. The Internal Clock.....	34
3-1-4. Notes on Safety.....	35
3-2. DAT.....	36
3-2-1. DAT Specifications.....	36
3-2-2. On the A-Time (absolute time).....	38
3-2-3. The DAT Cassette Tape.....	38
3-2-4. Erase Protect Hole.....	39
3-2-5. Loading and Ejecting of the Tape.....	39
3-2-6. Non-recorded Section and No Sound Recorded Section.....	40
3-2-7. The Sub ID.....	41
3-3. Setting the Internal Clock.....	41
3-4. The rack mount adaptor.....	43

3-1. Precautions in operation

3-1-1. Precautions for installation

Do not use this equipment in the following locations:

- * Extremely hot or cold locations.
- * High humidity locations.
- * Dusty locations.
- * Strong vibration locations.
- * Near a strong magnetic field.
- * Under direct sunlight or near heating equipment.

3-1-2. Precautions on dewing

Like all DAT recorders, if the D-15 is moved abruptly from a cold environment to a warm or humid one, it is possible for moisture to form inside the transport causing "dewing." In this situation, the recording tape can adhere to internal metal surfaces of the transport. This can damage the tape or cause serious recording problems. In such a situation, we advise that the recorder be brought to where it is to be used and left there for a few hours before operation so that the transport will reach room temperature and thus avoid dewing.

In view of the above, should dewing occur in D-15, the dew sensor will function, and the following error message shown in the display. The equipment will not operate. In this case, immediately switch off power, let the equipment stand for about two hours until it warms up to room temperature before operating it again.

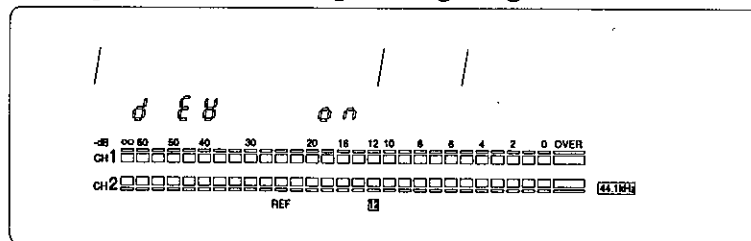

1. When the sensor detects dew with no tape in the transport. The above error message will be displayed and the transport will not function.
2. When the sensor detects dew with a tape in the transport. The above error message will be displayed and, at the same time, all lamps of the [OPEN/CLOSE] key as well as the transport control buttons will blink and operation will stop.

3-1-3. The Internal Clock

Nothing is set in the internal clock when the recorder leaves the plant. Please refer to "Setting the internal clock," page [41] to set the year, month and day.

3-1-4. Notes on Safety

- * Be sure to connect the D-15 to the power supply specified in the specifications section of this owner's manual. Do not use an AC outlet of any other voltage.
- * When removing the power cord from a wall outlet, always grasp and pull on the plug. Pulling the cord directly is very dangerous and could also break the inner wire.
- * Do not pull the plug with wet hands. It is very dangerous because you could receive a serious electrical shock.
- * Always make a secure connection between the D-15 and the wall outlet.
- * It is very dangerous to use a power cord whose outer sheath is cut or worn. If the cord is damaged, immediately stop using it and replace with a new cord.
- * Do not switch off the power with a cassette tape loaded. Make it a rule to switch off power only after removing the cassette.
- * It is recommended that you unplug the D-15 if it is not to be used for long periods of time.
- * Do not remove any outer covers or touch any internal components. You could receive a dangerous electric shock. Also, it is very easy to damage the internal mechanism and circuits.
- * Do not allow any liquids such as water, combustible matter, or metallic objects such as hair pins to get inside, especially in the transport section. This can cause a major breakdown and is also very dangerous. Should water, etc. accidentally get inside, immediately switch off power, unplug the power cord from the wall outlet and consult your nearest Fostex dealer or Fostex service center.
- * Do not drop or subject the D-15 to strong mechanical shocks. Doing so could damage the inner circuits and panels.

3-2. DAT

3-2-1. DAT Specifications

The D-15 is a professional digital audio recorder that complies to specifications for DAT (Digital Audio Tape System) by the IEC.

Consumer DAT specifications consist of the following 4 parts:

Part 1: Dimensions and Characteristics

Part 2: DAT Calibration Tape

Part 3: DAT tape properties

Part 4: Methods of Measurement for DAT Recorders

HEAD CONSTRUCTION

In DAT, a rapidly rotating helical scan head is employed, and, together with high density metal tape, DAT recorders maintain a high frequency bandwidth of several MHz for the digital signal. In the D-15, a two head drum with a diameter of 30mm and tape wrap angle of 90 degrees is employed.

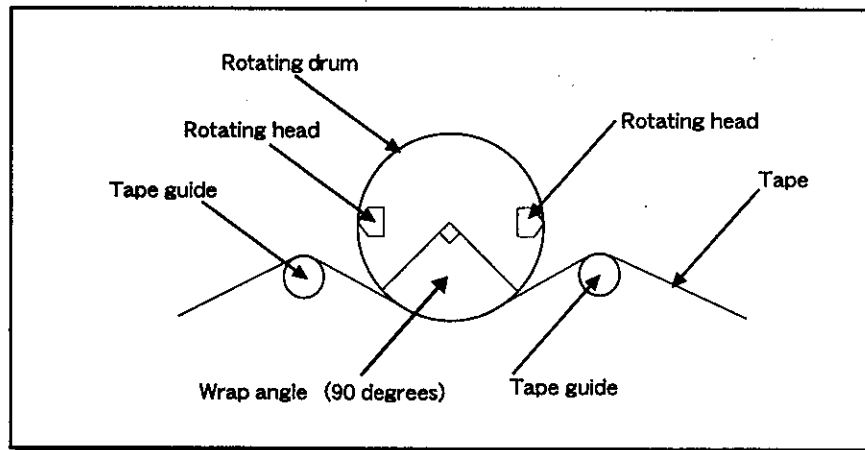

ORDER OF SAMPLING

In consumer DAT, both two channel simultaneous sampling and two channel alternate sampling are approved. Because two channel simultaneous sampling is employed in the D-15, a phase difference of about 10μ sec. is created, when a tape which had been recorded using two channel alternate sampling, is played back.

TRACK FORMAT

As shown below, DAT track format consists of various information blocks recorded on one track. Because of this, various ID's and time codes can be recorded without affecting the audio signal. The purpose of splitting the sub data and ATF areas into two locations is to correct burst error caused by the tape and make it possible to read data in the high speed search mode.

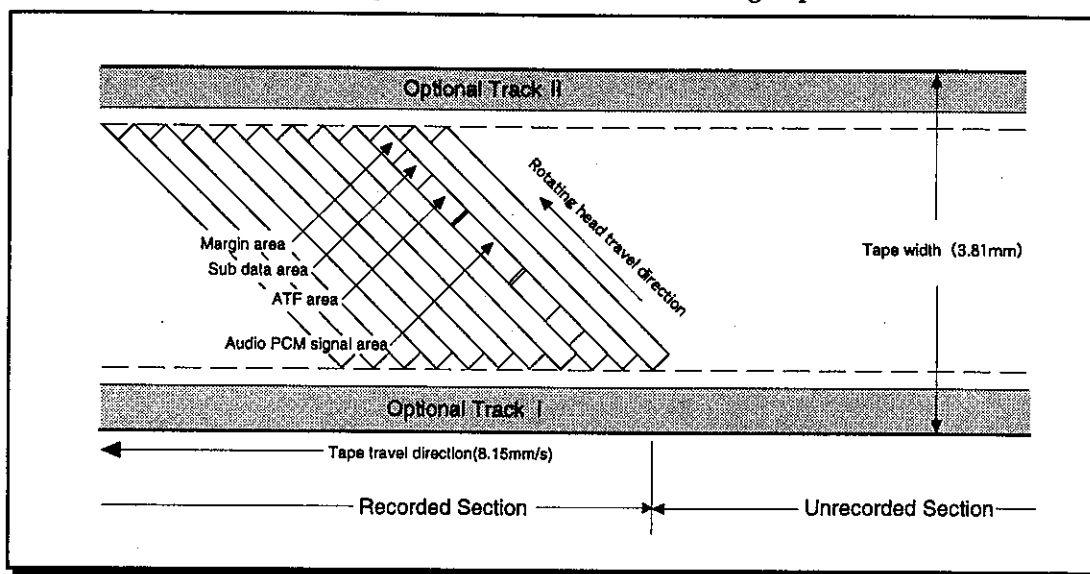

(1) Audio PCM Signal area

In addition to audio signals (L-R mixed) converted to digital data by PCM (Pulse Code Modulation) and main data consisting of error correction codes (Double Reed Solomon code), main ID to identify the audio data content are also recorded.

(2) Sub Data area

Data other than audio, such as Start-IDs, P NOs. and A-Time are recorded in this area. Recording capacity of this area is four times that of a CD and many future applications can be expected.

Time code data, for instance, is all recorded here.

(3) ATF (Automatic Track Finding/Following) area

A tracking signal, for accurate tracing of the head at playback, is recorded here. This consists of the 130kHz pilot signal and the track identifying signal.

DIGITAL AUDIO INTERFACE

Digital audio interface is a serial self synchronizing transmission specification used between interconnected digital audio equipment and is standardized in IEC 958. This is identical to CP-340 of the EIAJ specification and consists of the following two formats:

* Professional Use: IEC958 Part 3 (AES/EBU)

* Consumer Use: IEC 958 Part 2 (S/P DIF)

The broadcasting studio use format is identical to AES/EBU although AES/EBU is usually used. Channel status is different between these two formats in regards to expandability in professional use.

Inputs of the D-15 complies to both formats and the outputs are fixed to the XLR-3 connector for AES/EBU and the optical output to S/P DIF.

Outputs related to RAM such as instant start is not available at the optical output. Therefore, AES/EBU output is recommended for copying except for those containing S-ID.

CONNECTING SPECIFICATIONS

The following two types are specified in the IEC specifications.

- (1) Balanced type: XLR connector, cable impedance 110 Ω .
- (2) Unbalanced type: US pin jack, cable impedance 75 Ω .

In the IEC specification, nothing is specified as to which should be used but normally, the balanced type is employed for the AES/EBU format and the unbalanced type for the S/P DIF format.

These are, however, specifically noted in the EIAJ specifications.

3-2-2. On the A-Time (absolute time)

In DAT, absolute time, called A-Time, is automatically recorded on the tape when it is run in the record mode. This A-Time indicates tape position by elapsed time from the head of the tape and, once recorded, cannot be erased. In the D-15, various functions using this A-Time can be done so it is important that the A-Time be continuous for accurate execution of various operations. Therefore, the recording mute function must be used to assure recording a continuous A-Time on the tape.

3-2-3. The DAT Cassette Tape

Cassettes developed exclusively for the DAT format are used in the D-15. This cassette is more compact than conventional cassette tapes and can record/playback on one side only.

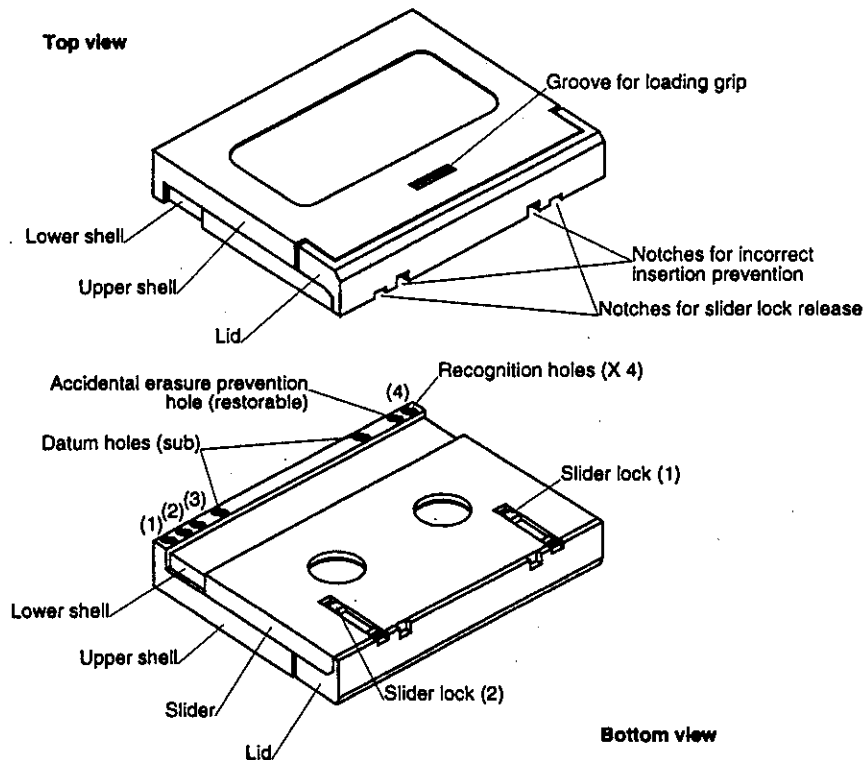

3-2-4. Erase Protect Hole

An erase protecting tab is provided in the DAT tape as shown in the schematic. This is to protect against accidental erasing of a prerecorded tape. In order not to erase a recorded tape, move this erase protecting tab as shown in the schematic.

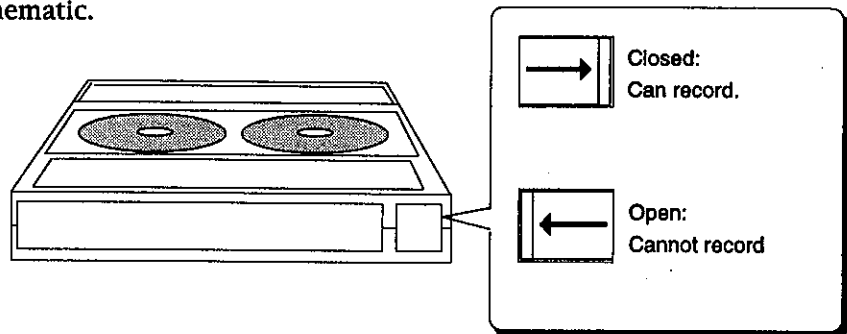

3-2-5. Loading and Ejecting of the Tape.

Tape handling in the D-15 is carried out by the following procedures:

1. Switch the power on the D-15.
2. Slide open the cassette tray by pressing the [OPEN/CLOSE] key.
3. Load the cassette tape.
4. Close cassette tray by pressing the [OPEN/CLOSE] key again.
In addition, it is also possible to close the tray by pressing either the [STOP] or [PLAY] buttons.
5. To remove the cassette tape, press the [OPEN/CLOSE] key.

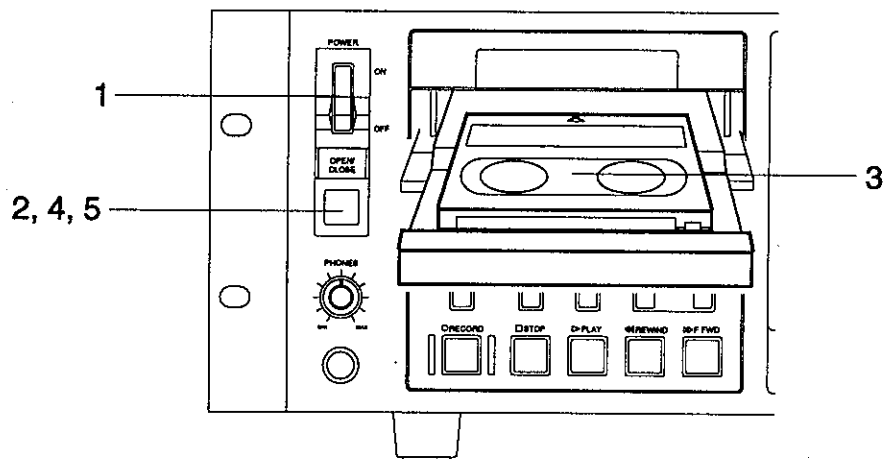

3-2-6. Non-recorded Section and No Sound Recorded Section.

In conventional analog tape recorders, to insert blank sections in tape such as between tunes the tape is advanced by play or fast forward (nonrecorded) or recording without sound (no sound recorded). However, in DAT the following difference between "nonrecorded section" and "no sound recorded section" must be understood.

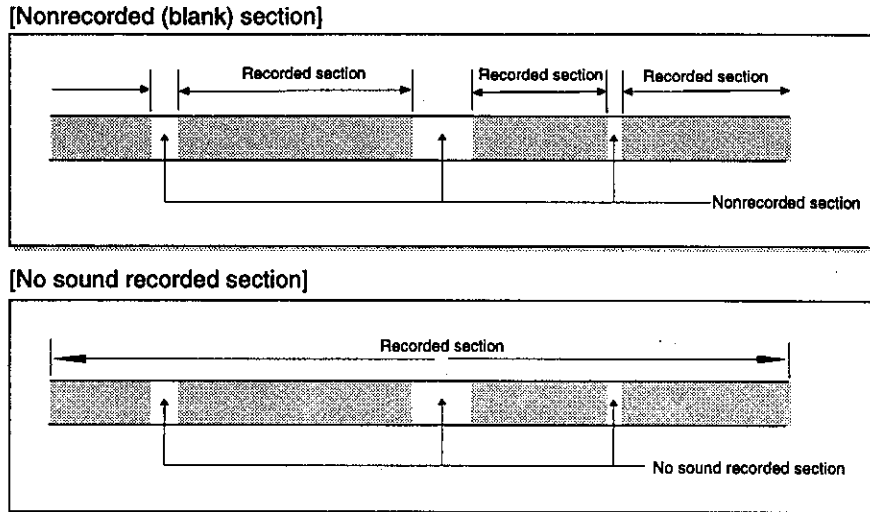

As seen here, for the non-recorded section and no sound recorded section, there is a clear distinction between a "blank section" made via play or fast forward without entering the record mode and that made by no sound recording. The "blank section" made in analog recorders in either case are the same in terms of "no sound."

However, if a "non-recorded section" is made on a DAT tape, A-Time which is automatically recorded during record mode will be interrupted or it will require a longer time to search for the recording start point. Therefore, in a DAT recorder, it is important not to make a "nonrecorded section" but to make a "blank section" by "no sound recording."

◆ Refer to page [50] for details on No Sound Recorded Section.

3-2-7. The Sub ID

In DAT recorders, in addition to normal music signals (audio data), various control signals (sub ID) for more convenient control of record/play, etc. can be recorded in the sub data area. The following are some sub ID examples.

SUB ID	CONTENT	RECORD	ERASE
Start ID (S-ID)	This is the signal indicating the start of the tune and it is used to locate the recording start point.	○	○
Program number (P NO)	This is the number designated on the S-ID and it is used to specify the desired tune and locate to its starting point.	○	○
Skip ID (SKIP ID)	If the tape is in the middle of a sound recording, this signal will make it skip to the next sound recording.	○	○
End ID (END ID)	Signal indicating the end of a recording.	○	○

< NOTE >

The SKIP-PLAY mode is set by selecting this in the SETUP mode of the D-15.

◆ Refer to page [101] for details on the SETUP mode.

3-3. Setting the Internal Clock

Because the D-15 contains a clock, accurate present date and time can be displayed, and recording date can be recorded on the tape. Use the following procedure to accurately set the present date and time.

Setting Procedures

1. Switch on the power to the D-15.
2. Press the [DISP TIME] key to change the display to [DATE].
The presently set date and time will appear in the display (Nothing is set when the recorder leaves the plant).

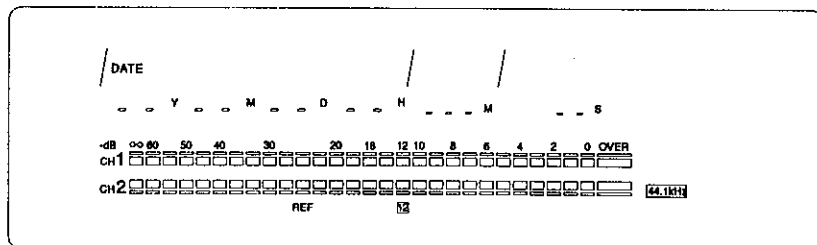

3. Next, press the [QUIT/RCL] key.

When the [QUIT/RCL] key is pressed, the date edit mode will be entered and the displayed "Y (year)" will blink. This blinking area (edit point) indicates that the numbers for this area can be changed.

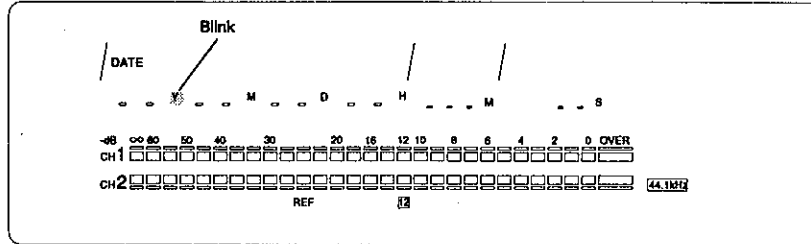

4. The [SHUTTLE] dial is manipulated to shift the point to a new location.

Shifting of the point by the [SHUTTLE] dial will be as follows. Additionally, the edit point will shift automatically to a new location if a two digit number is entered at the edit point from the numerical keypad as outlined below.

When rotated clockwise	The edit point will shift to the right.
When rotated counter clockwise	The edit point will shift to the left.

5. Enter the number to be changed by the numerical keypad or [JOG] dial.

Numerical keypad	Numbers can be entered directly and when two digits are input, the edit point will shift to a new point.
JOG dial	When rotated clockwise, the number will increase and also count up. When rotated counterclockwise, the number will decrease and, at the same time, count down.

<NOTE>
The edit point cannot be shifted via the jog dial.

6. Upon completing the change, press the [EXECUTE/SET] key to store any changes in memory.

After storing is completed, the internal clock will start running under the set data.

3-4. The rack mount adaptor

Rack mount adaptors are installed as standard equipment on both sides of the D-15. When the D-15 is mounted on a rack, it can be mounted in two different ways as shown below by changing the installation point of the adaptors. Select either one type in accordance to your preference.

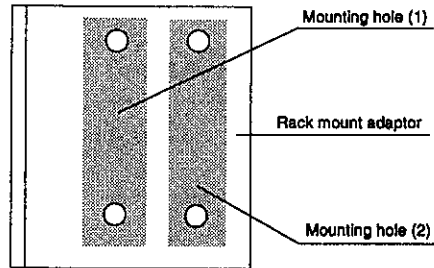

1. Using the (1) screw mounting hole

The D-15 can be mounted with its front panel extended out front from the rack front plane.

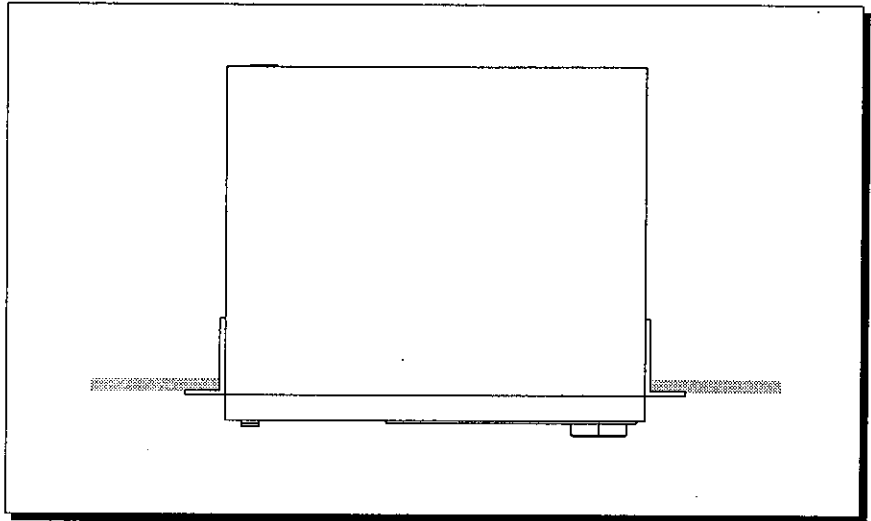

2. Using the (2) screw mounting hole

The D-15 can be mounted with its front panel about flush with the rack front plane.

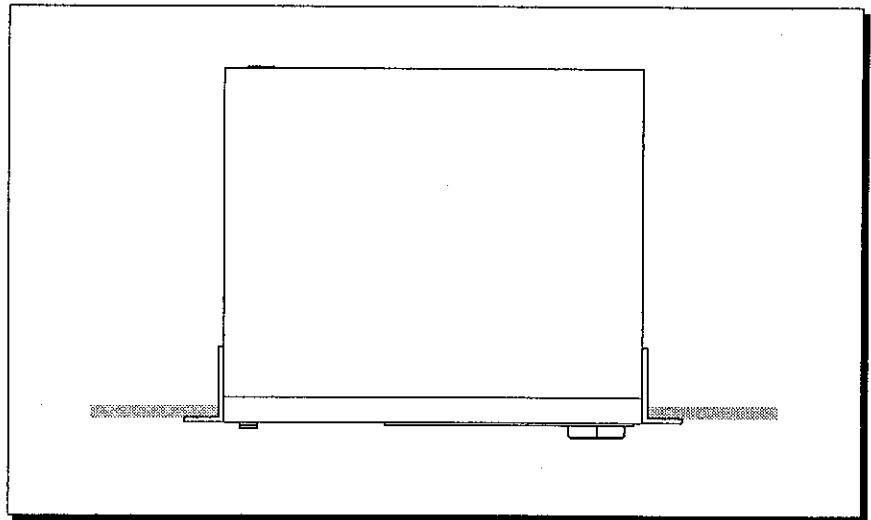

Chapter 4. Record and Playback

In this chapter, in addition to basic operating methods for recording and playback by the D-15, search/locate, AUTO REC mode, INSTANT START mode and AUTO CUE mode are also explained.

Chapter 4. Table of Contents

4-1. Basic Playback	45
4-2. Basic Recording	46
4-2-1. Analog Audio Recording.....	46
4-2-2. Digital Audio Recording.....	49
4-3. Making a No Sound Recorded Section (REC MUTE)	50
4-4. Blank Search	51
4-5. AUTO REC (The Auto Recording) Mode	52
4-5-1. Setup of Memory [00] and Memory [01].....	52
4-5-2. Rehearsal of AUTO REC.....	54
4-5-3. Changing the memory data (punch in/out point).....	55
4-5-4. Execution (take) of AUTO REC.....	57
4-6. Cueing	58
4-6-1. Cueing by the JOG/SHTL mode.....	58
4-6-2. Cueing by the RAM SCRUB mode.....	59
4-7. The Search/Locate Function	60
4-7-1. S-ID Search.....	61
4-7-2. Locating using P NO (Program Number).....	62
4-7-3. Locating with the MEM NO (Memory numbers).....	63
4-7-4. Time Locate.....	64
4-8. The INSTANT START Mode	65
4-8-1. SINSTANT START Operation.....	65
4-8-2. Executing INSTANT START after moving the start point.....	66
4-8-3. Preview of INSTANT START by the PREVIEW/REPEAT key.....	67
4-8-4. Trimming of INSTANT START via the PREVIEW/REPEAT key.....	68
4-8-5. Locating using INSTANT START.....	69
4-9. The AUTO CUE Mode	70
4-9-1. S-ID Search/P NO Locate in the AUTO CUE mode.....	71
4-9-2. When tape is loaded in the AUTO CUE mode.....	72

4-1. Basic Playback

The following will explain basic playback operations using the D-15.

Connecting external equipments

At playback of a prerecorded tape in D-15, connect external equipments as shown in the following schematic. As two analog output connectors, namely the XLR-3-32 type (balanced line) and the RCA type (unbalanced line) are provided, the most suitable type can be used for your application.

< NOTE 1 >

Always switch off the power to all equipment including the D-15 when making interconnections.

< NOTE 2 >

In regards to connecting and operating equipment other than the D-15, please also refer to the operating manuals of the respective equipment.

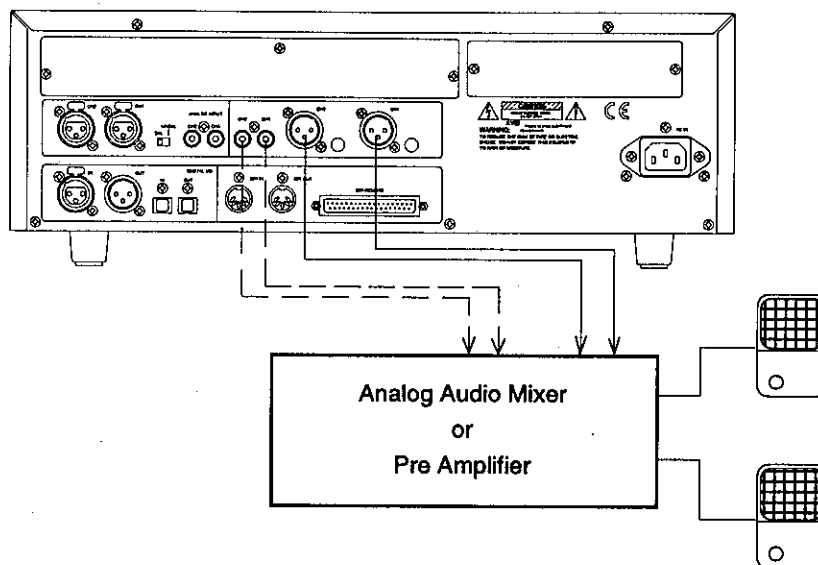

Check items before operation

1. Switch on the power to D-15.
2. Load the cassette tape.
3. Switch the [REMOTE] selector to [LOCAL].

Operating Procedure

1. Press the [PLAY] button.
The [PLAY] button lamp will light and playback of the tape will start.

< NOTE >

The display section [44.1kHz] or [48kHz] will blink if the FS recorded on the tape is different from the sampling frequency selector switch setting but it will be played back automatically based on the FS information on the tape.

Adjusting the standard output level

Although standard output level at the D-15 analog output connectors are +4dBu at the XLR-3-32 type (balanced line) and -10dBV at the RCA type (unbalanced line), these standard output levels can be minutely adjusted within the +/-2dB range to match the external equipment connected to D-15. Adjusting can be made with the trimmers located adjacent to the analog output connectors.

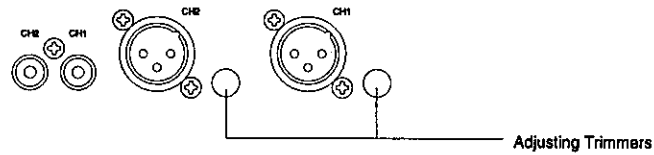

4-2. Basic Recording

4-2-1. Analog Audio Recording

Connections

External equipments are connected as follows when recording analog audio signals. As two analog input connectors, namely the XLR-3-31 type (balanced line) and the RCA type (unbalanced line) are provided, the most suitable type can be used for your application. When using the balanced or unbalanced type, be sure to set the [BAL-UNBAL] selector switch to match this output type thus selected.

< NOTE 1 >
 Always switch off the power to all equipment including the D-15 when making interconnections.

< NOTE 2 >
 In regards to connecting and operating equipment other than the D-15, please also refer to the operating manuals of the respective equipment.

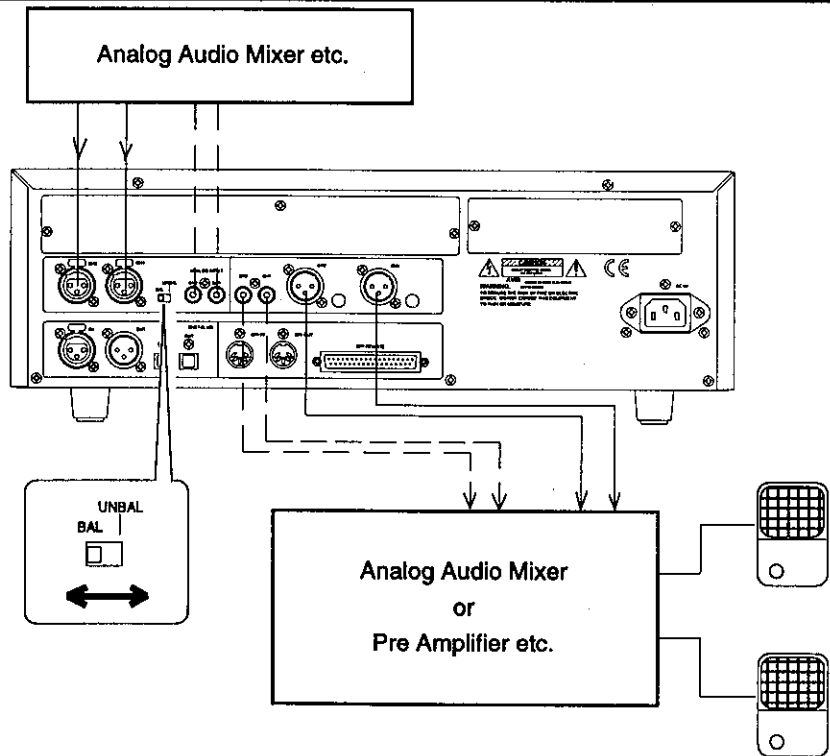

Check items before operating

1. Switch on power to D-15 and the external equipments connected to it.
2. Set the DAT tape for recording.
3. Switch input selector to [ANALOG].
4. Select the sampling frequency for recording with the sampling frequency selector switch.
5. Set CH1, CH2 [INPUT LEVEL] knobs to the reference position (CAL position). For adjusting the recording level, refer to the next "Adjusting the recording level for the analog audio signal."
6. Set the [REMOTE] selector to [LOCAL].
7. Set the [CLOCK] switch to [INT].
8. Check that the [INSTANT START] key LED is extinguished.
9. Check that the [AUTO REC] key LED is extinguished.
10. If S-ID/P NO is to be automatically recorded while in the recording mode, switch ON the [AUTO-ID] key as required (Refer to "Chapter 5 Record/ Erase of Sub ID" in regards to recording of S-ID/P NO using the [AUTO-ID] key).

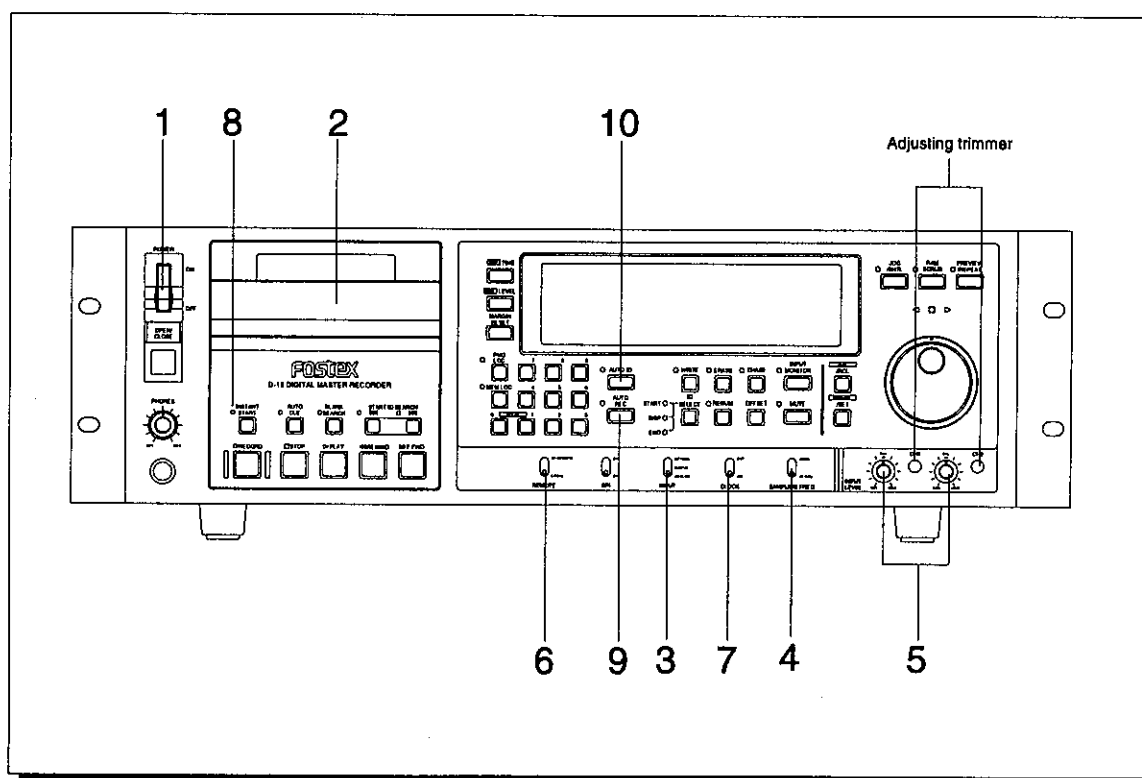

Adjusting Record Level of the Analog Audio Signal

1. To adjust the recording level, press the [INPUT MONITOR] key to switch "ON" the input monitor (The [INPUT MONITOR] key LED will be lit).
2. Input the analog audio signal, and while checking by the level meter, adjust the recording level with the [INPUT LEVEL] knobs (CH1, CH2).
The D-15 level meter holds for about 3 seconds (*) in the display the input signal peak value.

* Adjust the [INPUT LEVEL] knob so that the peak value is less than 0dB.

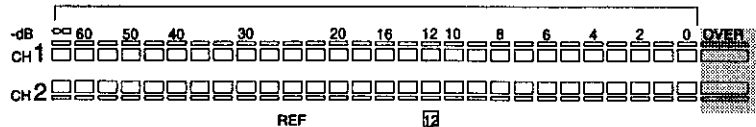

(*) The D-15 peak hold time can be changed in the SETUP mode. Initial setting at leaving the plant is the above mentioned 3 seconds.

◆ Refer to page [105] for "Setting the peak hold time" in the SETUP mode.

<Points at level adjusting>

- * Adjust the [INPUT LEVEL] knob so that the peak value is less than 0dB.
- * Adjust the [INPUT LEVEL] knob so that the level meter [OVER] is not lit.
- * The margin display will be renewed each time a signal larger than the presently displayed figure is input and the display figure will also change.

This can be used as a substitute for permanent peak hold. The margin level and input level of channel 1 and channel 2 can be checked by switching with the [DISP LEVEL] key.

<NOTE>
The sound will be distorted when the input level exceeds "0dB".

3. Upon finishing the recording level adjustment, switch "OFF" the input monitor by pressing the [INPUT MONITOR] key (The [INPUT MONITOR] key LED will be extinguished).

Adjusting the reference position (CAL) level of the input level knob

Reference position (CAL), of the input level knob used at analog audio signal recording, can be minutely adjusted in level within +/-2dB. Adjusting is by the trimmers located aside the input level knobs. It must be noted, however, not to touch this unless absolutely necessary.

Making the recording

1. After finish setting the above mentioned switches and the recording level, press the [PLAY] button while holding down the [RECORD] button.
The [RECORD] and [PLAY] button lamps will be lit and recording started.
At the sam time, the input monitor will change to automatic input monitor and the [INPUT MONITOR] key LED will blink.
2. Press the [STOP] button to end the recording.

4-2-2. Digital Audio Recording

Connections

To record digital audio signals, the external equipment should be connected as shown below. XLR-3-31 type (IEC 958 Part 3=AES/EBU format) connector and an optical connector (IEC 958 Part 2=S/P DIF format) are provided for input of digital signals. Select either type to match your application. If an optical cable is to be used, the Model 8562 is recommended.

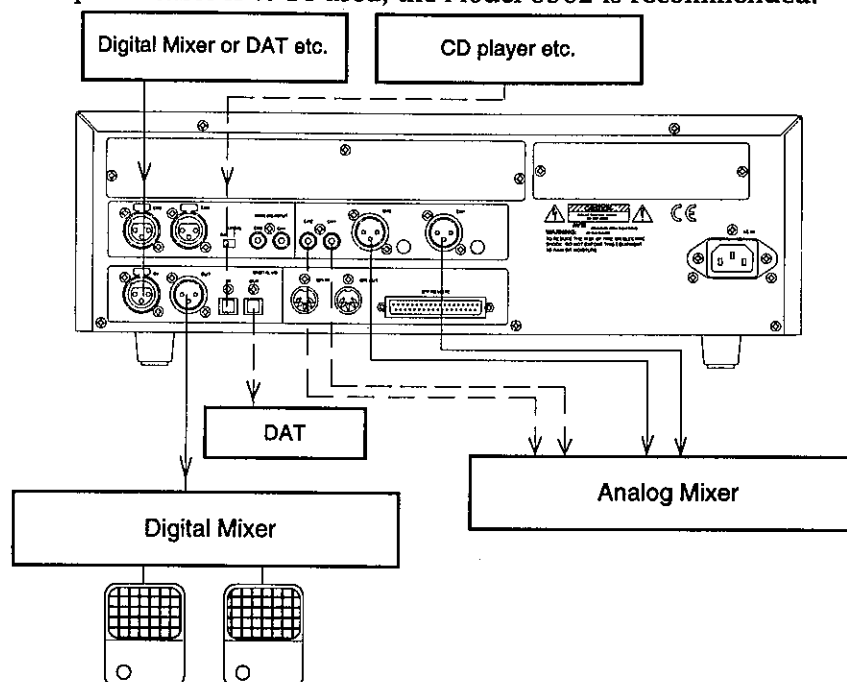

Check items before recording

Set the [INPUT] selector switch to [DIGITAL] or [OPTICAL] to match the connector to which digital audio signals are to be input and set the sampling frequency selector switch to match the input digital signal. Thus, check that [DIGITAL IN] is lit in the display section.

<NOTE>

Should the digital signal not be correctly input to D-15 and if the setting is wrong, the display section [DIGITAL IN] will blink in warning. In such a case, check the connections and settings and be sure [DIGITAL IN] is NOT blinking before starting to record.

Recording procedure

1. After checking the above setup items, press the [PLAY] button while holding down the [RECORD] buttons.
The lamps of both the [RECORD] and [PLAY] buttons will light, recording will start, and the recorder will enter automatic input monitor and the [INPUT MON] LED will blink.
 - * When recording digital signals, because it is automatically recorded at the same level as the input digital signal, level adjusting is not necessary on the D-15.
2. Press the [STOP] button to end the recording.

4-3. Making a No Sound Recorded Section (REC MUTE)

As explained in "Check items before recording," in order to make a blank (between a tune) in a DAT tape, A-TIME recorded on the tape must be continuous. The following record mute is done to make a no sound recorded section while maintaining continuity of A-TIME on the tape.

* The following series of operation can be applied to both ANALOG IN and DIGITAL IN.

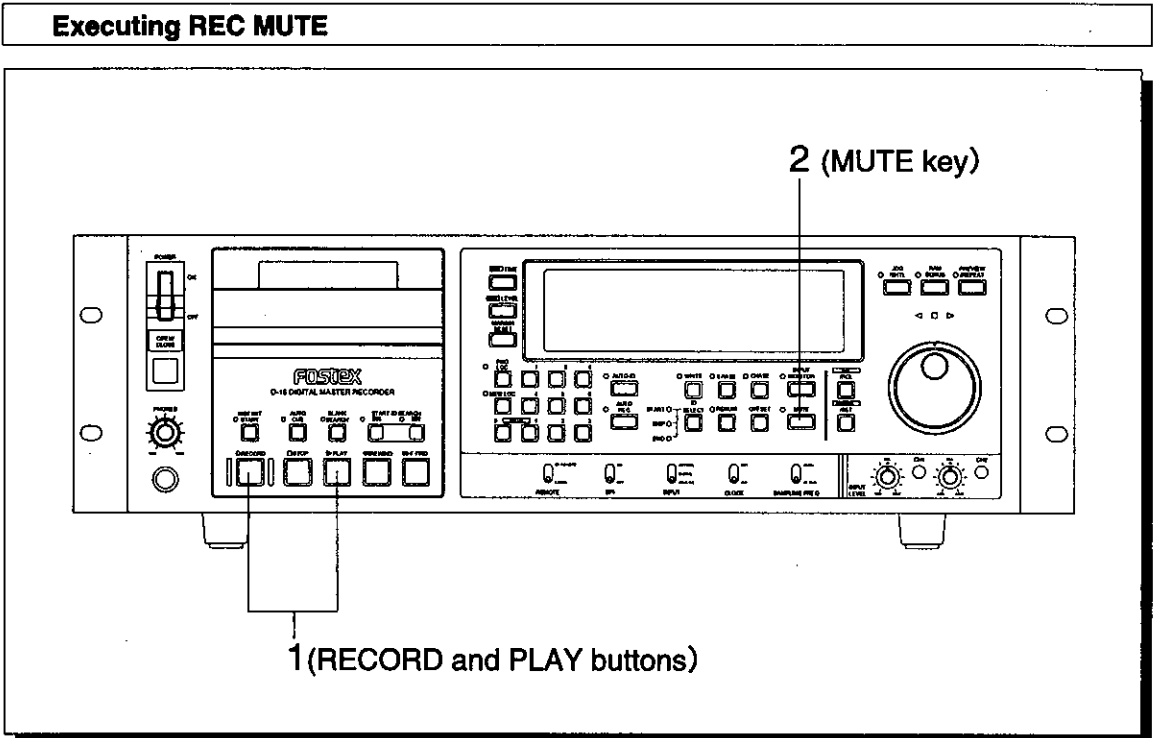

1. While pressing the [RECORD] button, press the [PLAY] button to start recording.
2. While in the record mode, continue pressing the [MUTE] key from the point where the no sound recorded section is to be made.
The [MUTE] key LED will continue to be lit while the key is held down (during record mute execution).
In D-15, since REC MUTE will be executed as long as the [MUTE] key is held down, the [MUTE] key is simply released to end it.

A continuous no sound recorded section of A-TIME can be made as shown in schematic below by these procedures.

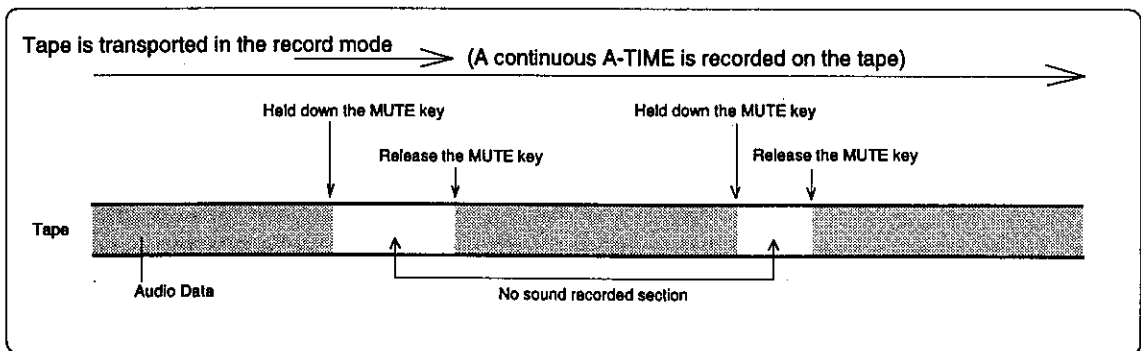

4-4. Blank Search (Continue Recording Without Making a Nonrecorded Section)

Blank search is the process of finding the tape recording end position and the END-ID. If this function is used at recording, a continuous recording can be made without making non-recorded sections on the tape.

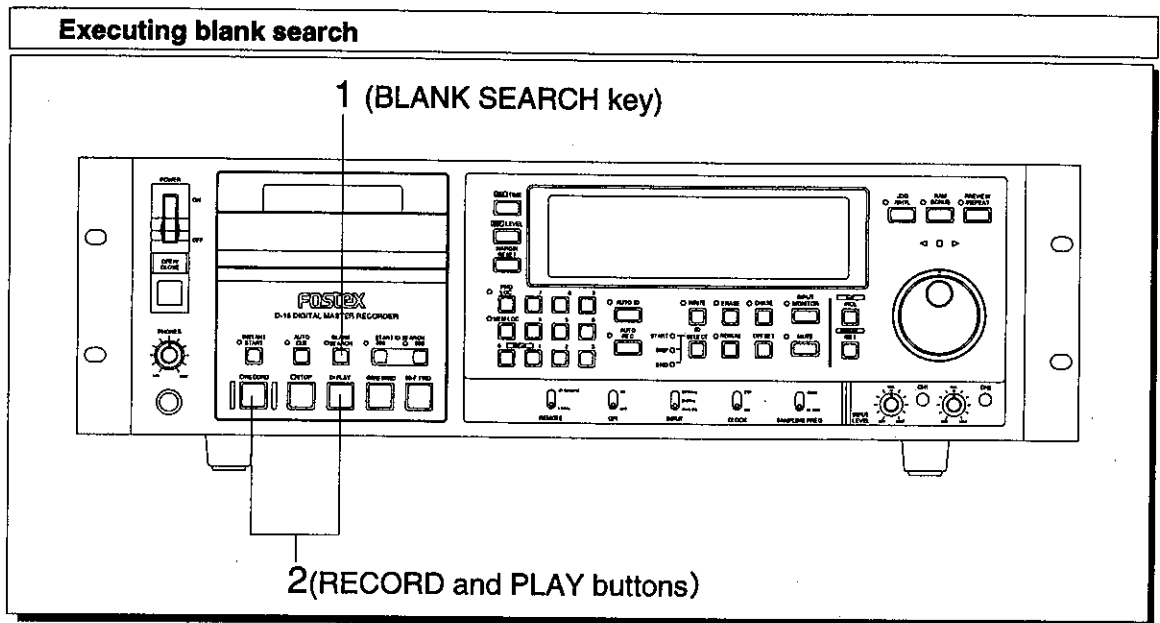

1. Search the non-recorded section by pressing the [BLANK SEARCH] key. The BLANK SEARCH LED will be lit during execution and be extinguished at completion of search. As shown in the schematic below, tape will pause two seconds prior to the tape non-recorded section or the END-ID.
 2. After completion of blank search, press the [PLAY] button while pressing the [RECORD] button to start the recording. As recording will be started two seconds prior to the non-recorded section or END-ID, recording can be continued without making a non-recorded section.
- * If tape is loaded at the non-recorded section or a virgin tape is loaded, blank search is automatically carried out.

< NOTE 1 >

As blank search will also be carried out automatically if a cleaning tape is loaded and tape will be rewound to the start, stop tape by pressing the [STOP] button.

< NOTE 2 >

Blank search cannot be done in the instant start mode.

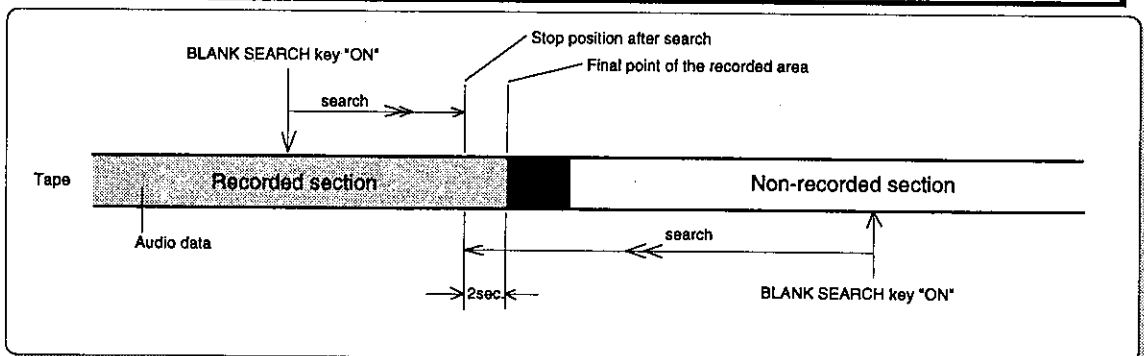

4-5. AUTO REC (The Auto Recording) Mode

AUTO REC is the function of automatically recording between A-Time memories [00] and [01] (auto punch in and out).

< NOTE 1 >

When the AUTO REC mode is switched "ON," the INSTANT START and AUTO CUE modes are automatically canceled.

< NOTE 2 >

It is necessary for A-TIME to be recorded for more than ten seconds prior to the memory [00] point for execution of AUTO REC.

< NOTE 3 >

Auto record by the D-15 is for assemble recording only and A-TIME continuity, as well as, error rate in the punch out section is not guaranteed.

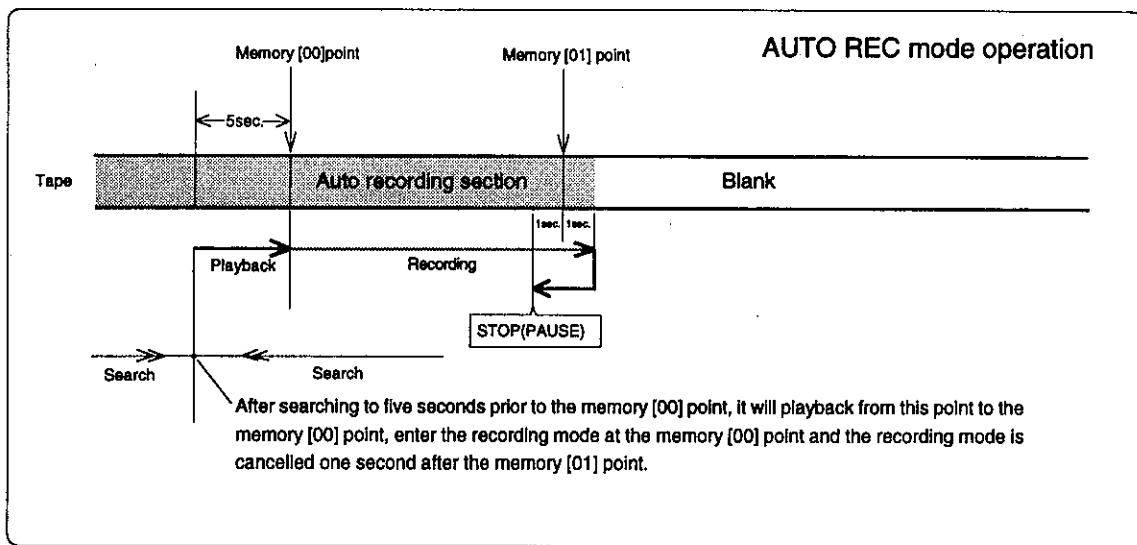

4-5-1. Setup of Memory [00] and Memory [01]

Memory [00] and Memory [01] must be set prior to executing AUTO REC.

< NOTE >

AUTO REC can be executed without setup of memory [01]. In other words, if for example, recording is to be continued to the end in the AUTO REC mode without punching out, memory [01] need not be setup. However, if a random figure is previously set in memory [01] for a purpose other than AUTO REC (For example, time locate), then set memory [01] for instance, to "00:00:00:00."

Should AUTO REC be executed as it stands, it could punch out at an unexpected point.

Execution of AUTO REC

1. Change to A-TIME display by pressing the [DISP TIME] key.
2. Searching for the recording point by cueing.
Switch "ON" the JOG/SHTL mode key and search the point using the [JOG] or [SHUTTLE] dials.

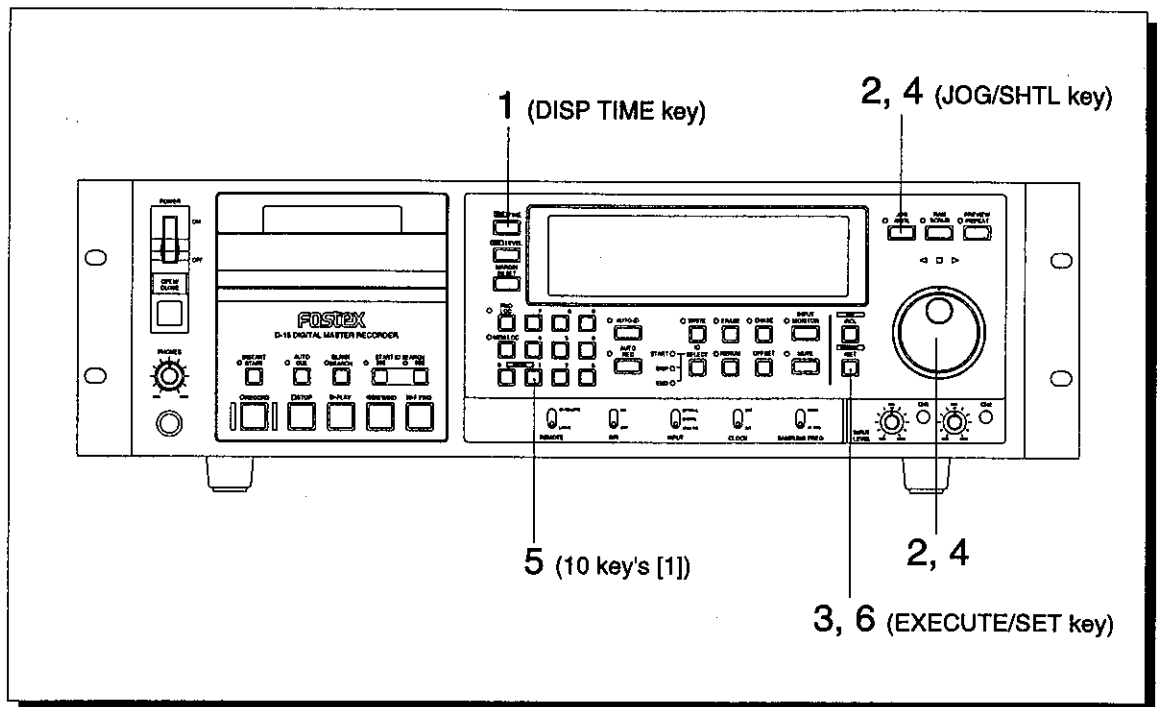

3. Press the [EXECUTE/SET] key upon determining that point.
By the steps up to this point, recording start time (punch in point) is stored in memory [00].
4. Search for the recording end point using same procedure as in above item 2.
* If recording is to be carried out to the end without punching out, set to "00:00:00:00."
5. Press the ten keypad [1].
[NEXT] will be displayed at the instant the key is pressed and [001] will be shown in the [NEXT] display section.
6. Press the [EXECUTE/SET] key.
As a result, the Ending time (punch out point) is thus stored in Memory [01].

Confirming the memory [00] and [01] data

To confirm the time in memory [00], press [0] of the numerical keypad, then press the [QUIT/RCL] key.

Also, to confirm the time in memory [01], press [1] of the numerical keypad, then the [QUIT/RCL] key.

The time stored in memory [00] or [01] will be shown in the display.

After confirmation, either press the [QUIT/RCL] key or [DISP TIME] key again and it will return to the A-TIME display.

Upon confirming the stored time, proceed to the next rehearsal.
Refer to "4-5-3. Changing the Memory Data" if the stored time is to be changed by editing.

4-5-2. Rehearsal of AUTO REC

Before actually executing AUTO REC, conduct rehearsal to confirm the recording start position (punch in point) setup in memory [00].

At rehearsal, actual recording is not carried out and operates as shown below.

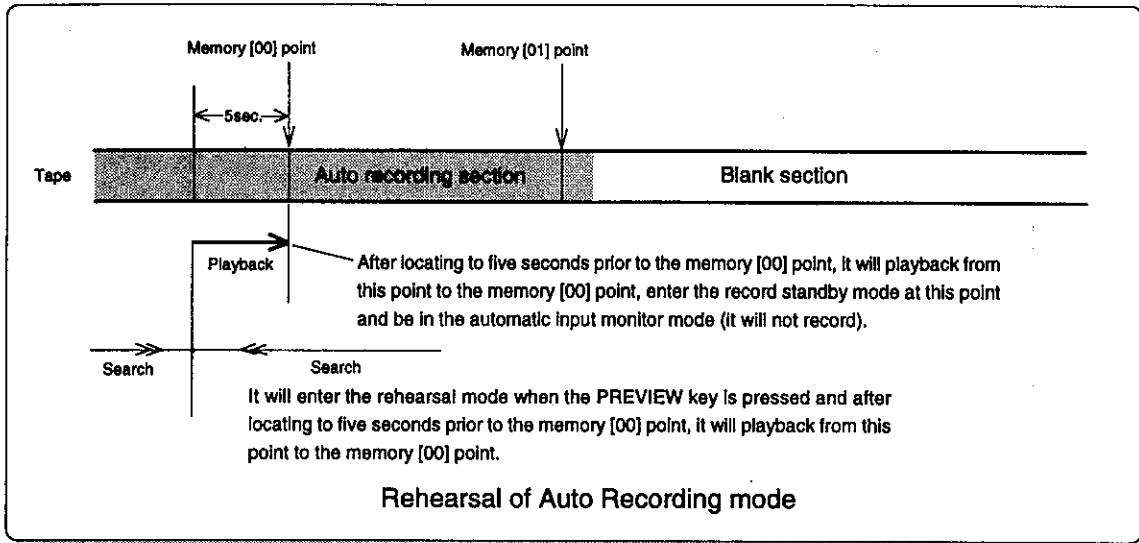

Execution of rehearsal

1. Change to the A-TIME display by pressing the [DISP TIME] key.
2. Press the [AUTO REC] key and check that its LED blinks (AUTO REC mode standby).
3. Press the [PREVIEW/REPEAT] key (its key LED will be lit).
*When this key is pressed, tape is located to 5 seconds before the memory [00] point (MEM LOC LED will be lit) and playback started toward the memory [00] point (when playback is started, the PREVIEW/REPEAT LED will be extinguished).
In rehearsal, the recorder automatically enters INPUT MONITOR and PAUSE when it arrives at the memory [00] point (The INPUT MONITOR LED, [RECORD]/[PLAY] button lamps, and the AUTO REC LED will all blink).*
4. To repeat rehearsal, press the [PREVIEW/REPEAT] key again.
5. Press the [STOP] button to end the rehearsal.

4-5-3. Changing the memory data (punch in/out point)

After carrying out rehearsal, there are the following two methods in changing the punch in/out point and re-storing it into Memory [00] or Memory [01]. In the following, time in Memory [00] will be changed as an example. Follow the same procedures also at changing Memory [01].

Making corrections by cueing in the JOG/SHTL or RAM SCRUB modes

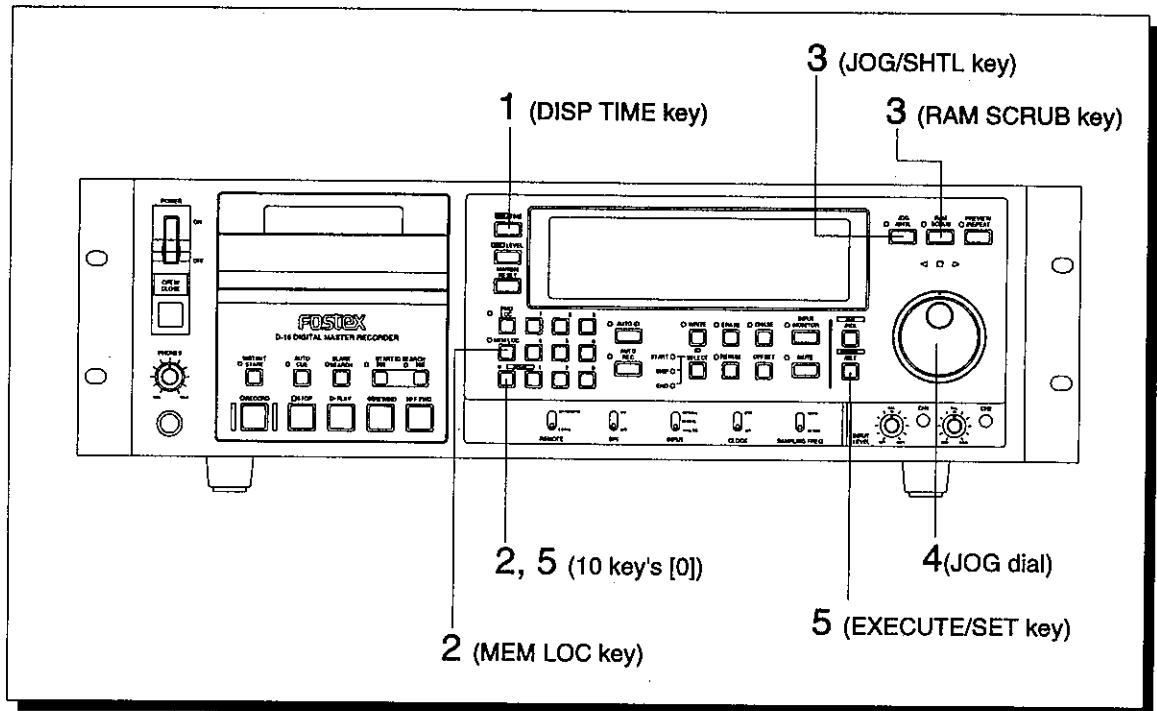

1. Change to A-TIME display by pressing the [DISP TIME] key.
2. If tape is not at the Memory [00] position, press the ten keypad [0] then, the [MEM LOC] key.
*The tape will locate to the Memory [00] point and stop.
In order to locate to the memory [01] point, press [1] of the numerical keypad, then the [MEM LOC] key.*
3. Press the [JOG/SHTL] key to switch "ON" the JOG/SHTL mode (the [JOG/SHTL] key LED will be lit). Or, press the [RAM SCRUB] key to switch "ON" the RAM SCRUB mode.
When the RAM SCRUB mode is switched "ON," standby for the RAM SCRUB LED to change from blinking to a constant light before proceeding to the next operation.
4. Move the point with the [JOG] or [SHUTTLE] dials while monitoring with the headphone.
5. After moving the point, press the numerical keypad [0], then the [EXECUTE/SET] key.
To store it in memory [01], press the numerical keypad [1], then the [EXECUTE/SET] key.

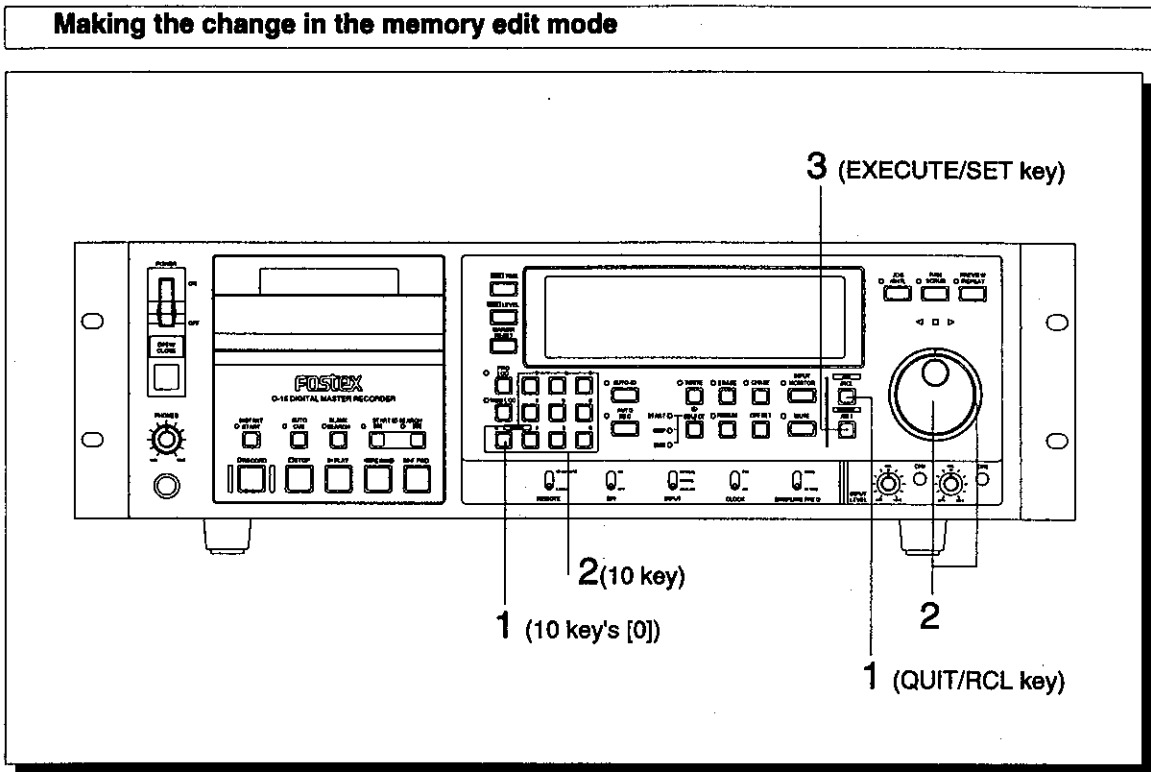

1. After pressing the ten keypad [0], press the [QUIT/RCL] key.
*Simultaneous with display of the memory [00] time, it will enter the memory edit mode (As an example, the display [H] will blink and time of memory [00] will be displayed).
 If time of memory [01] is to be called, press the numerical keypad [1], then the [QUIT/RCL] key.*

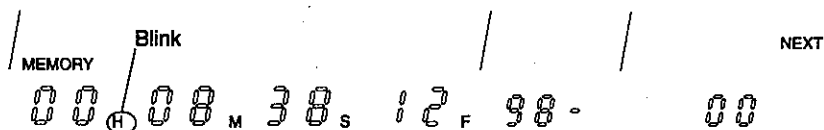

2. Move the point to be edited with the [SHUTTLE] dial, then enter the number with the ten keypad or the [JOG] dial.
*When the SHUTTLE dial is rotated clockwise, the blinking digit will shift in order of [H]->[M]->[S]->[F]->[NEXT]->[H] and if rotated counter clockwise, it will shift in reverse order.
 Also, if a two digit number is input by the numerical keypad in the blinking digit position, blinking will automatically shift to the righthand digit.*
3. Upon confirming that "00" is shown in the [NEXT] display, press the [EXECUTE/SET] key.
*The edited time is newly stored in memory [00].
 If it is to be stored in memory [01], press the [EXECUTE/SET] key after confirming that the [NEXT] display is [01].*

4-5-4. Execution (take) of AUTO REC

Check by rehearsal to see that AUTO REC is smoothly executed, and then, execute AUTO REC.

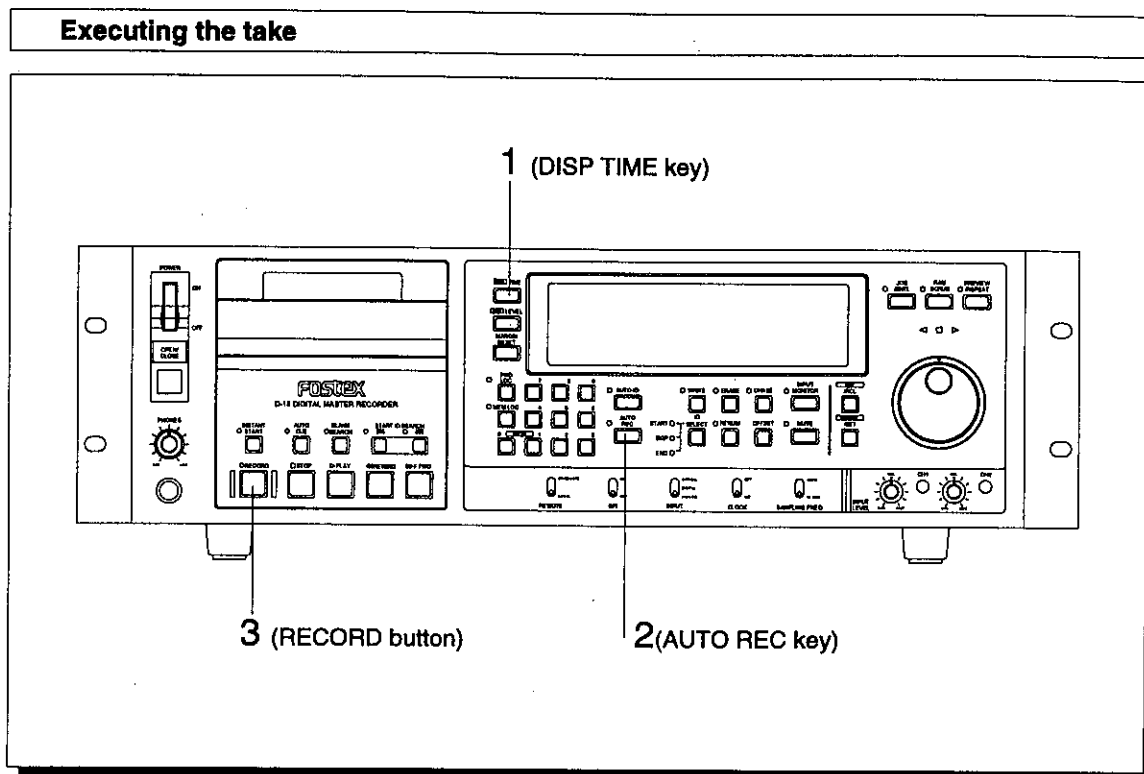

1. Change to A-TIME display by pressing the **[DISP TIME]** key.
2. Press the **[AUTO REC]** key and make sure the LED is blinking.
3. Press the **[RECORD]** button.

Same as with the rehearsal operation, it will locate five seconds prior to the memory [00] point and start playback. At take, after playback to the memory [00] point, it automatically enters the input monitor at this point, and at the same time, recording is executed ([RECORD] button = LED is lit, INPUT MONITOR LED = blinks) and ends recording at the memory [01] point.

< NOTE 1 >

At take, the sound may seem to be interrupted momentarily at the in point and out point but the recording will be in normal condition.

< NOTE 2 >

If AUTO REC is executed with the cassette tape erase protect hole open, rehearsal is possible in the normal manner but if "take" is executed it will not record and both [PLAY] and [RECORD] button lamps will fast blink.

4-6. Cueing

Cueing using the JOG/SHTL and RA SCRUB modes are explained here.

4-6-1. Cueing by the JOG/SHTL mode

In the JOG/SHTL mode, cueing is possible in the REWIND or F FWD direction while listening to the tape playback sound at 1/2~2 times speed by the [JOG] dial, and at 1/2~15 times speed by the [SHUTTLE] dial.

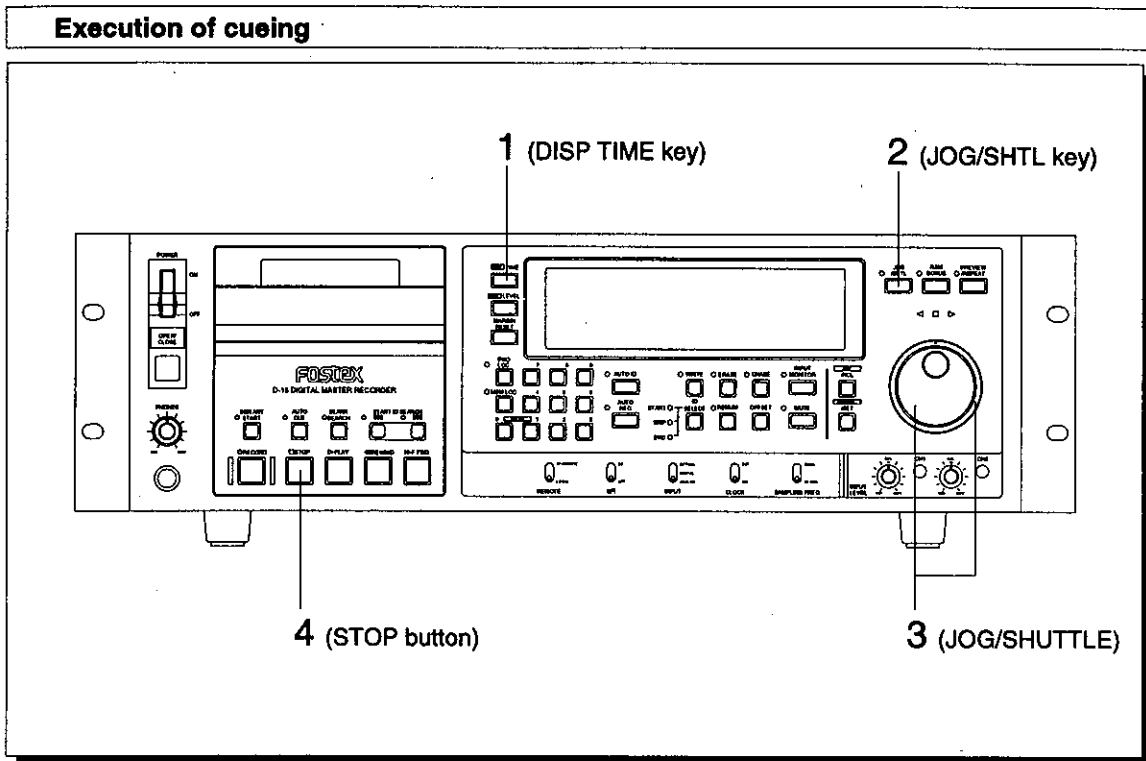

1. Change to A-TIME display by pressing the [DISP TIME] key.
 2. Press the [JOG/SHTL] key to switch "ON" the JOG/SHTL mode (JOG/SHTL LED and JOG/SHTL lamp [] will be lit).
 3. Start cueing by manipulating the [JOG] or [SHUTTLE] dials.
- * When the [JOG]/[SHUTTLE] dials are manipulated, D-15 will operate as follows.

SHUTTLE	Cueing will be in 1/2 - 15 times speed.
JOG	Cueing will be in 1/2 - 2 times speed.

4. To end the JOG/SHTL mode, press the [STOP] button or other tape transporting buttons.

4-6-2. Cueing by the RAM SCRUB mode

In the RAM SCRUB mode, cueing is possible in the REWIND or F FWD direction while listening to the playback sound recorded in the RAM at 0 time~1 time speed using the [JOG] or [SHUTTLE] dials.

* In the RAM SCRUB mode, cueing is possible on 1.5 seconds before and after the point where the [RAM SCRUB] key was pressed.

Execution of cueing

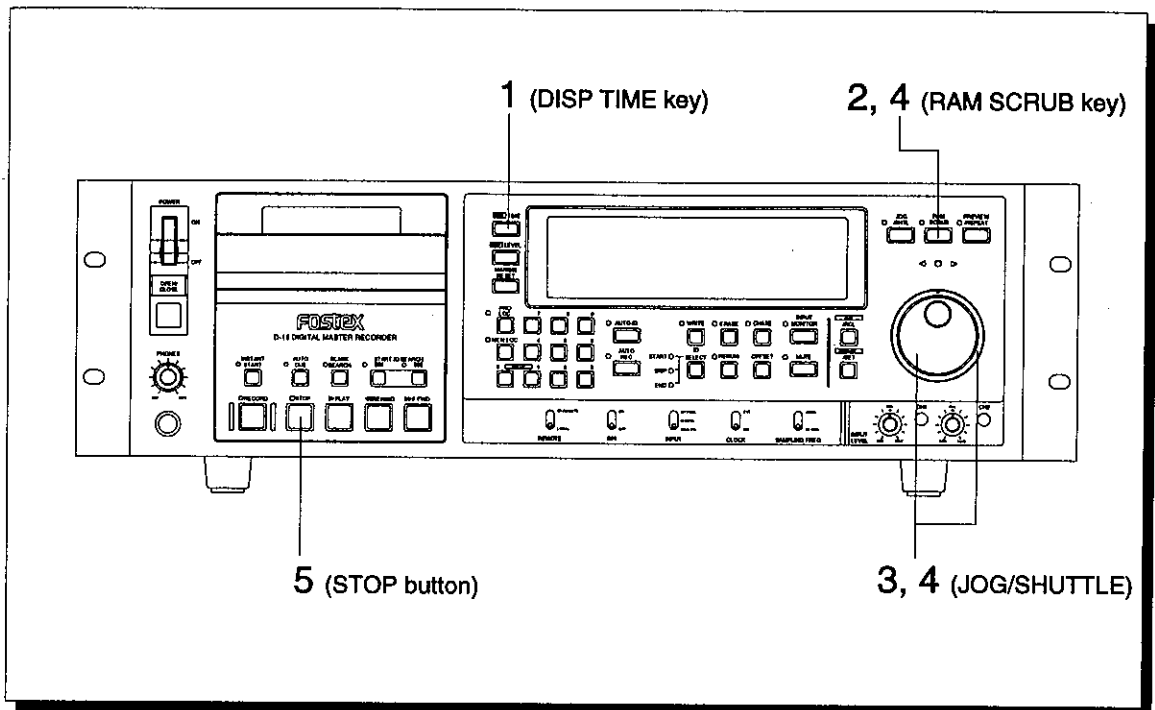

1. Change to A-TIME display by pressing the [DISP TIME] key.
2. Press the [RAM SCRUB] key to switch "ON" the RAM SCRUB mode (the JOG/SHTL lamp [] will be lit and the RAM SCRUB LED will change from blinking to a constant light).
3. Start cueing by manipulating the [JOG/SHUTTLE] dials (function of the JOG/SHUTTLE dials is the same as in the previous page).

** Outstanding features of RAM SCRUB**

In the JOG function, cueing is possible in less than one frame accuracy at the one time playback speed. Also, in the SHUTTLE function, cueing is possible at different playback speeds which is determined by the dial position (rotating angle).

4. If there is not enough area for cueing by RAM SCRUB, press the [RAM SCRUB] key again.
By pressing this again, as 1.5 seconds of AUDIO DATA located before and after the point where the key was pressed, can be newly reloaded in the RAM, cueing is carried out by the [JOG] or [SHUTTLE] dials after reloading (When reloading is started, the [RAM SCRUB] key LED will blink and change to constant lighting at completion of the reload.
5. To end RAM SCRUB, either press the [STOP] button or other tape transporting buttons.

4-7. The Search/Locate Function

Search by S-ID (start ID), locate by P NO (program number) and MEM NO (memory number) and also time locate (A-TIME) is possible in D-15 and operation of each are as follows.

1. S-ID search

The function of searching the S-ID recorded on the tape and use the present tape position as the reference, the S-ID randomly recorded before or after this reference point can be found. The S-ID search function can search to one second beforehand of the objective S-ID.

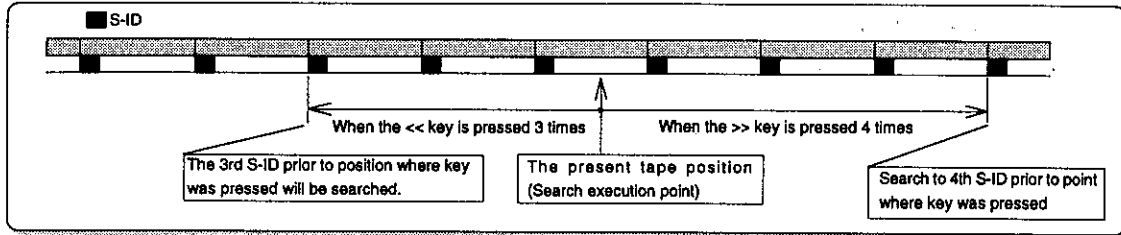

2. P NO locating

This is the function of locating to the program number which will be recorded and also S-ID already recorded on the tape, and regardless to the present position the desired P NO can be specified and located to one second beforehand of this P NO (S-ID).

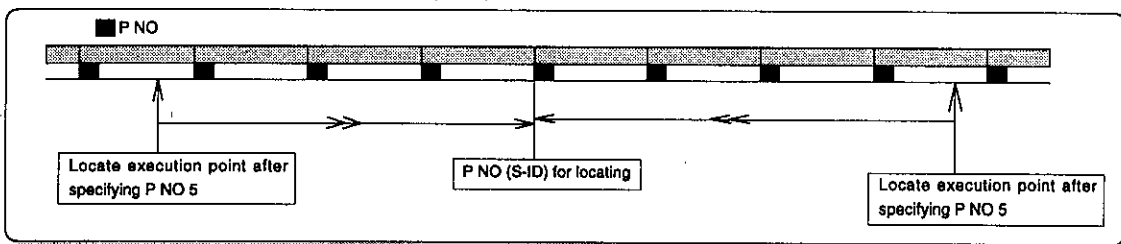

3. MEM NO locating

This is the function of locating to the time figure stored in a random memory number and, regardless to the present position, the desired memory number can be specified and located to that time figure. There are 100 numbers, [00]~[99] which can be stored in the memory and the A-TIME time information can be stored in the memory of any desired number. Normally, this function is carried out by storing the A-TIME time figure but operation by TC time figures will also be possible if the optional Model 8335 (TC/SYNC card) is installed in D-15 (Refer to the Model 8335 Owners Manual for details).

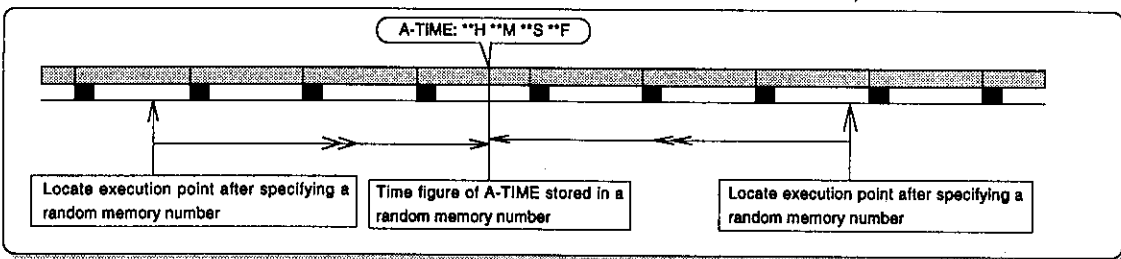

4. Time locate

The function of directly locating upon the A-TIME display to a randomly edited time figure. This function is normally carried out by the A-TIME time figure but if the optional Model 8335 (TC/SYNC card) is installed in D-15, operation by the TC time figure also becomes possible (Refer to the Model 8335 Owners Manual for details).

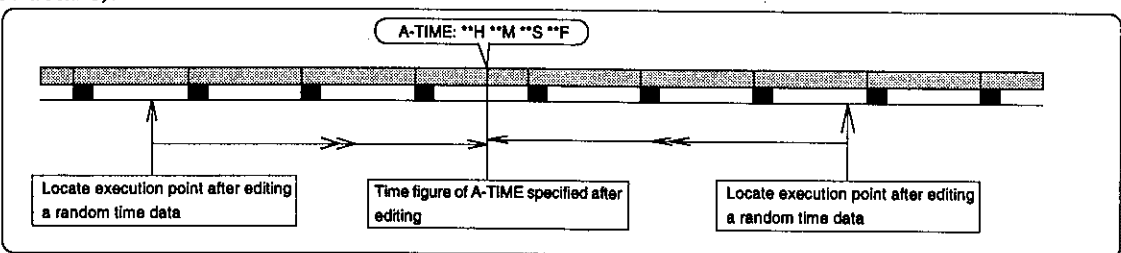

4-7-1. S-ID Search

An S-ID recorded on the tape will be searched.

Execution of S-IDs earch

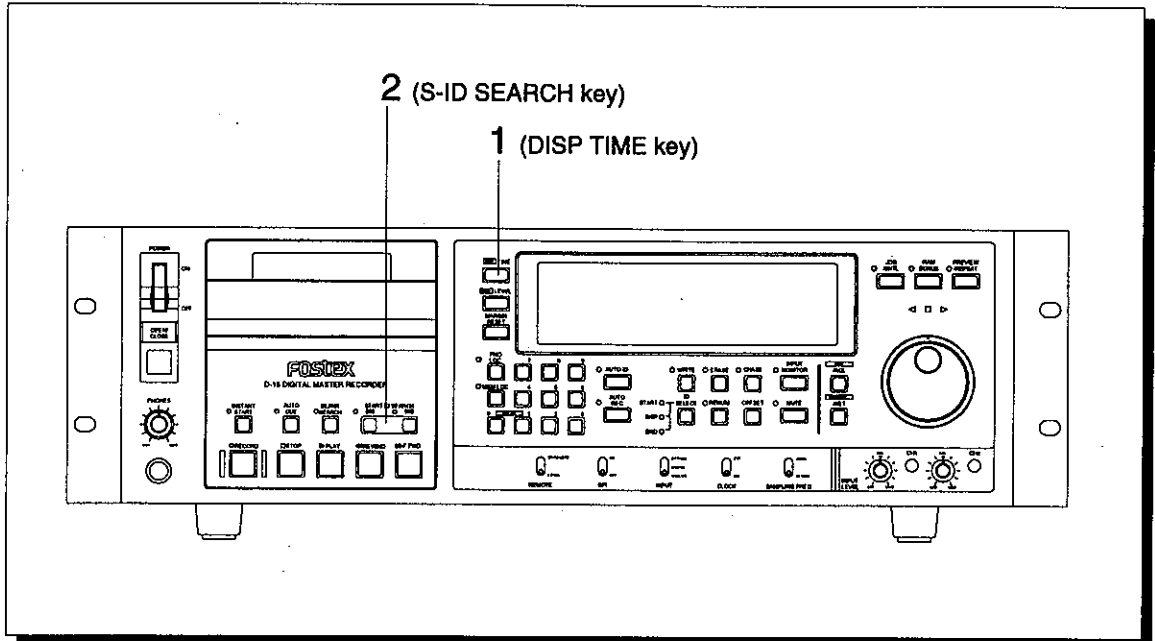

1. Change to A-TIME display by pressing the [DISP TIME] key.
2. Press the [>>] or [<<] keys of the [START ID SEARCH] key for the number of times equal to the amount of S-ID to be searched.
*If the above operation is carried out while A-TIME is on display, the number of times this key is pressed will be displayed with a [+] (when the [>>] key is pressed) or a [-] (when the [<<] key is pressed) and when the objective S-ID is found, [S-ID] will be lit and the P NO will be displayed.
 Also, if this operation is carried out while DATE is on display, DATE information at which it was recorded on the tape will be displayed and change to the present DATE display upon completion of the search.*

When [<<] key is pressed	S-ID for the number of times this key is pressed will be searched in the REWIND direction and PAUSE one second before the objective S-ID.
When [>>] key is pressed	S-ID for the number of times this key is pressed will be searched in the F FWD direction and PAUSE one second before the objective S-ID.

3. If the [PLAY] button is pressed while in the search function, the D-15 will enter PLAY upon completing the search.

If INSTANT START is switched "ON" before S-ID search is executed, INSTANT START can be executed from the searched point.

4-7-2. Locating Using P NO (Program Number)

The recorder will locate to the P NO specified in the [NEXT] display.

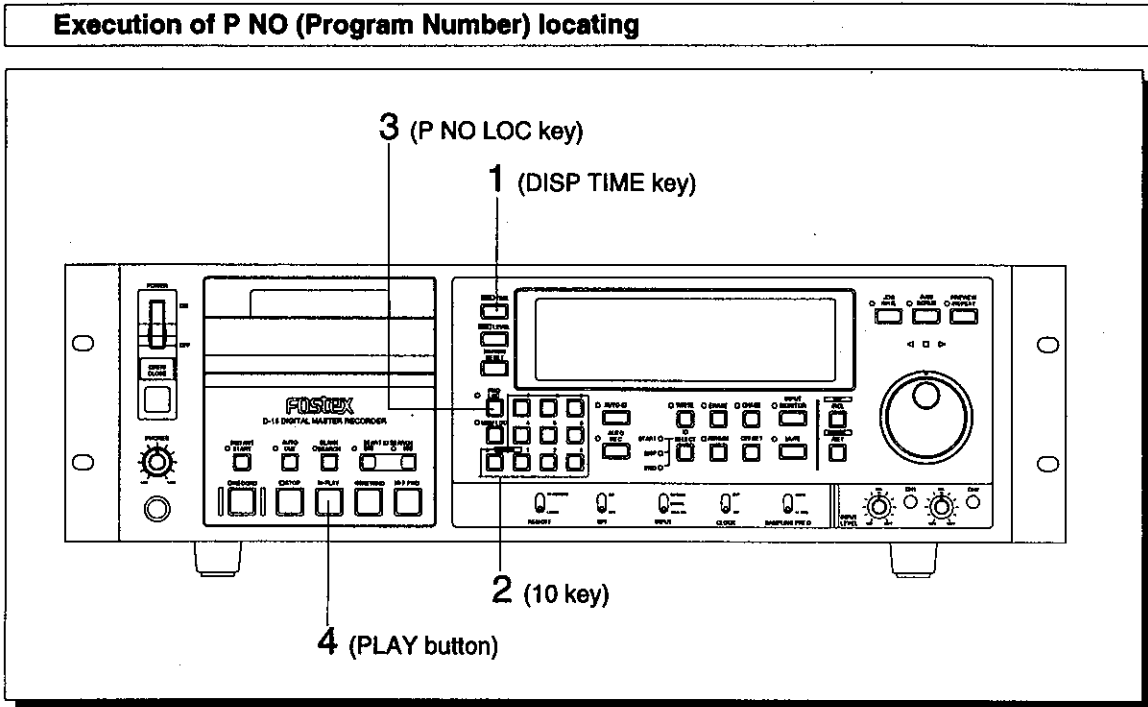

1. Change to A-TIME display by pressing the [DISP TIME] key.
2. The number of the P No to be located is specified via the [keypad].
When the keypad is pressed, the display will change to the [NEXT] display and the number specified from the keypad will be shown in the [NEXT] display.

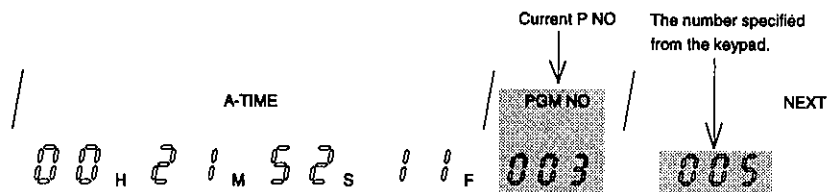

3. Press the [P NO LOC] key.
Locate function will be started and pause at one second before the desired P NO (S-ID). The P NO thus located will blink in the display.
- * Press the [STOP] button to interrupt the P NO locate function.

< NOTE >
If the P NO LOC key is pressed without specifying a P NO from the keypad, the recorder will locate to the P NO presently displayed in the PGM section of the display. If [---] is shown in the [PGM] display, this key will be ineffective.

4. If the [PLAY] button is pressed during locating, it will automatically enter PLAY upon completing the locating operation.

If INSTANT START is switched "ON" before P NO locate is executed, INSTANT START can be executed from the located point.

4-7-3. Locating With the MEM NO (Memory Numbers)

The tape will locate to the memory number specified in the [NEXT] display.

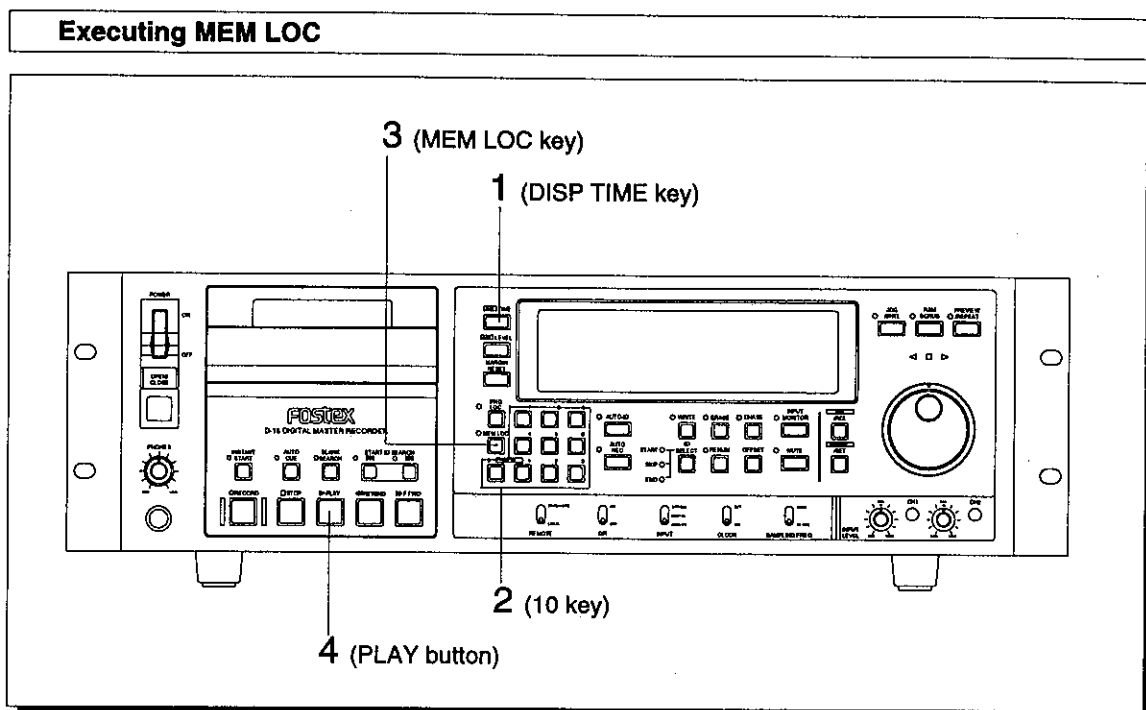

1. Change to the A-TIME display by pressing the [DISP TIME] key.
2. Specify the memory number to be located from the [keypad].
The display will change to the [NEXT] display when the keypad is pressed and the number entered will be shown in the [NEXT] display.
3. Press the [MEM LOC] key.
The locate function is started and PAUSED at the objective memory number (A-TIME).

< NOTE 1 >

If the [MEM LOC] key is pressed without specifying the MEM NO from the keypad, the tape will automatically locate to the time stored in memory number [00].

< NOTE 2 >

A maximum of two digits of the specified memory numbers 00-99 are effective and even if three digits are input, the 100th digit will be ignored. In other words, should 1, 2 and 3 (123) be input from the numerical keypad and locate is attempted, D-15 will start locating toward memory number [23].

4. If the [PLAY] button is pressed while in the locate mode, it will enter PLAY automatically after locating is completed.

* If the optional Model 8335 (TC/SYNC card) is installed, memory locating by TC time will also be possible in addition to A-TIME. For details, refer to the Model 8335 Owners Manual.

* If INSTANT START is switched "ON" before MEM NO locate is executed, INSTANT START can be executed from the located point.

4-7-4. Time Locate

The tape is located to the specified time.

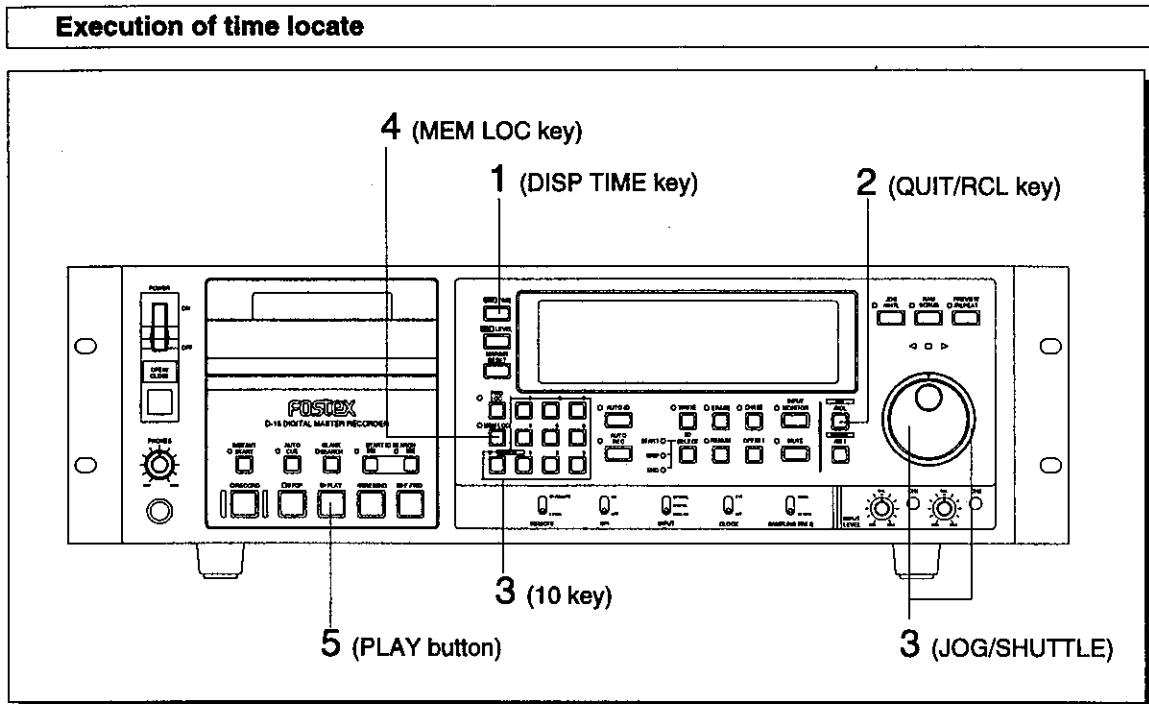

1. Change to the A-TIME display by pressing the [DISP TIME] key.
2. With A-TIME on display, press the [QUIT/RCL] key to enter the memory edit mode.
3. Move the time digit to be edited with the [SHUTTLE] dial and input the number from the [numerical keypad] or [JOG] dial.
*When the [SHUTTLE] dial is rotated clockwise, the blinking digit will shift in order of [H]->[M]->[S]->[F]->[NEXT]->[H] and if rotated counter clockwise, it will shift in reverse order.
Also, if a two digit number is input by the [numerical keypad] in the blinking digit position, blinking will automatically shift to the righthand digit.*
4. After setting, press the [MEM LOC] key.
The tape will locate to the specified A-TIME and pause.
5. If the [PLAY] button is pressed while in the locate mode, the tape will enter play automatically after locating is completed.

* If the optional Model 8335 (TC/SYNC card) is installed, time locating by TC time will also be possible in addition to A-TIME. For details, refer to the Model 8335 Owner's Manual.

* If INSTANT START is switched "ON" before TIME locate is executed, INSTANT START can be executed from the located point.

4-8. The INSTANT START Mode

INSTANT START is the function of instantaneously playing back the AUDIO DATA which had been previously recorded in the RAM for the purpose of extensively shortening the rise time of the playback sound.

4-8-1. INSTANT START Operation

Operating Procedure

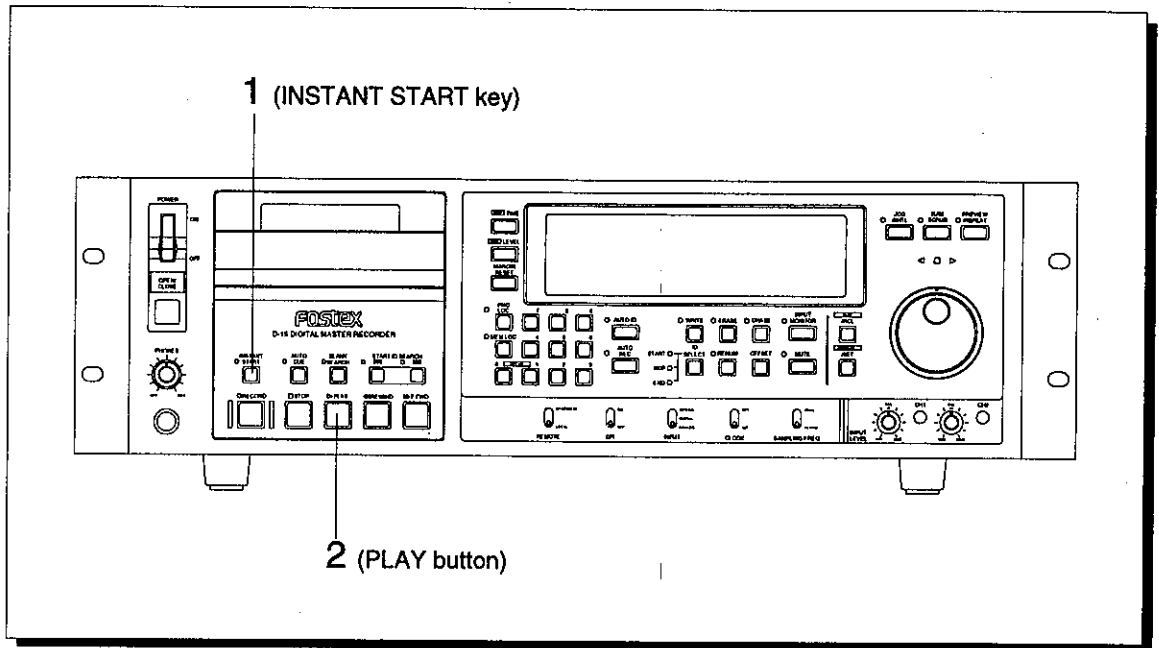

1. Press the [INSTANT START] key to switch "ON" the INSTANT START mode. Status of the INSTANT START mode will be indicated as follows by the INSTANT START LED.
INSTANT START can be executed when its LED changes to a constant light.

Blinking	The D-15 cannot instant start until the LED is lit as audio data is under recording in the RAM.
Lighted	D-15 can instant start.
Fast blink	D-15 cannot instant start as A-TIME, etc. is not recorded.

< NOTE >

INSTANT START will not function unless A-TIME is recorded on the tape.

2. Make sure the LED is lit, then press the [PLAY] button.

4-8-2. Executing INSTANT START After Moving the Start Point

Move the start point of INSTANT START by using the RAM SCRUB mode, then execute INSTANT START.

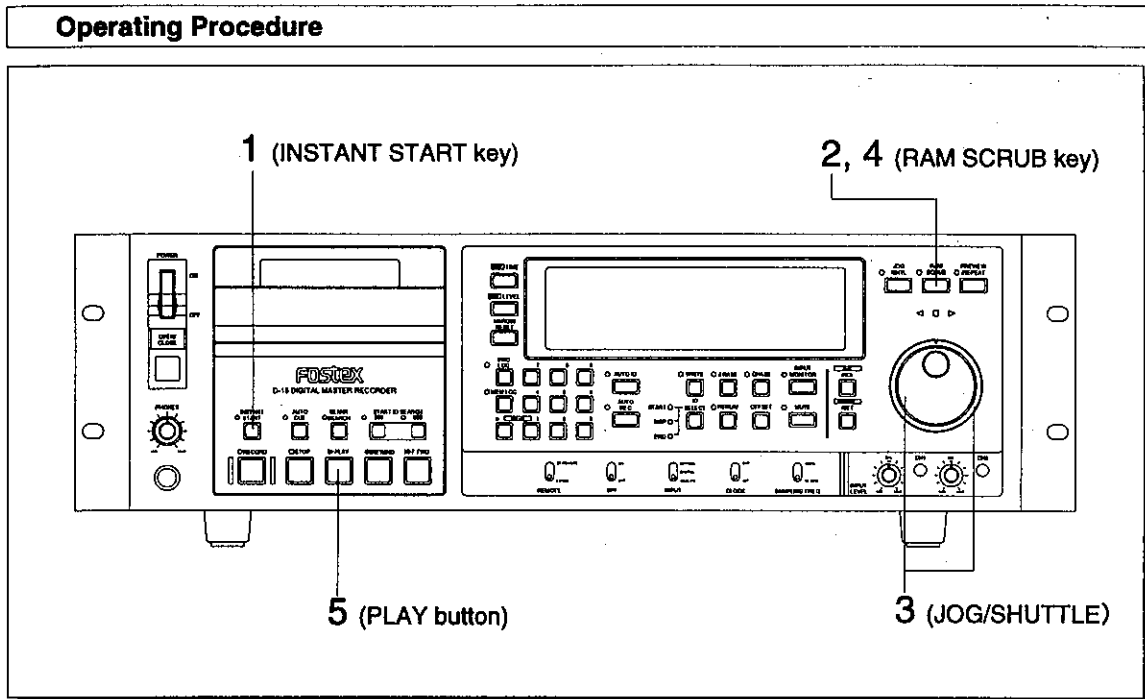

1. Press the [INSTANT START] key to switch "ON" the INSTANT START mode.
2. Press the [RAM SCRUB] key (RAM SCRUB LED will change from blinking to lighting).
3. Change the start point by manipulating and monitoring the [JOG] or [SHUTTLE] dials.
4. If RAM SCRUB is lacking in area, press the [RAM SCRUB] key again at the shifted point.
AUDIO DATA at 1.5 seconds before and after the point at which the key was pressed will be freshly loaded in the RAM.
5. After confirming completion of reloading and lighting of the RAM SCRUB LED, press the [PLAY] button.
INSTANT START will be executed from the moved start point.

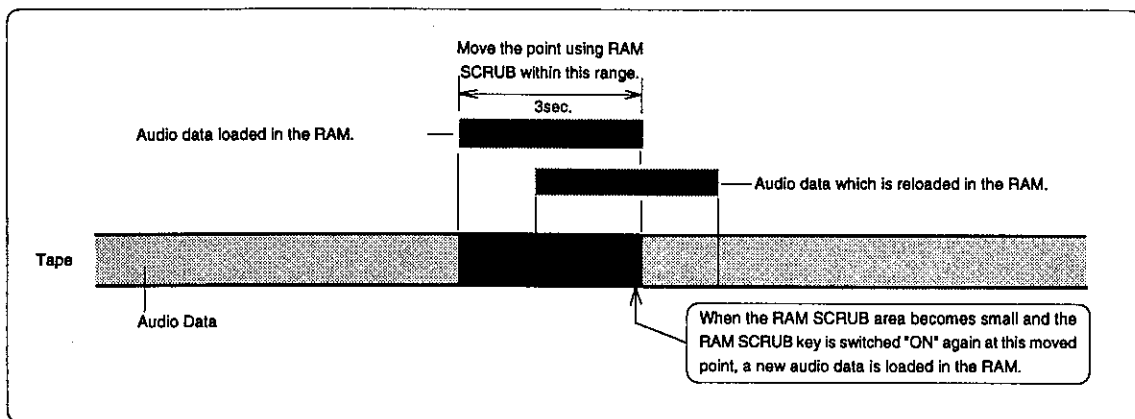

4-8-3. Preview of INSTANT START by the PREVIEW/REPEAT key

Rehearsal is carried out from the newly changed start point by using RAM SCRUB.

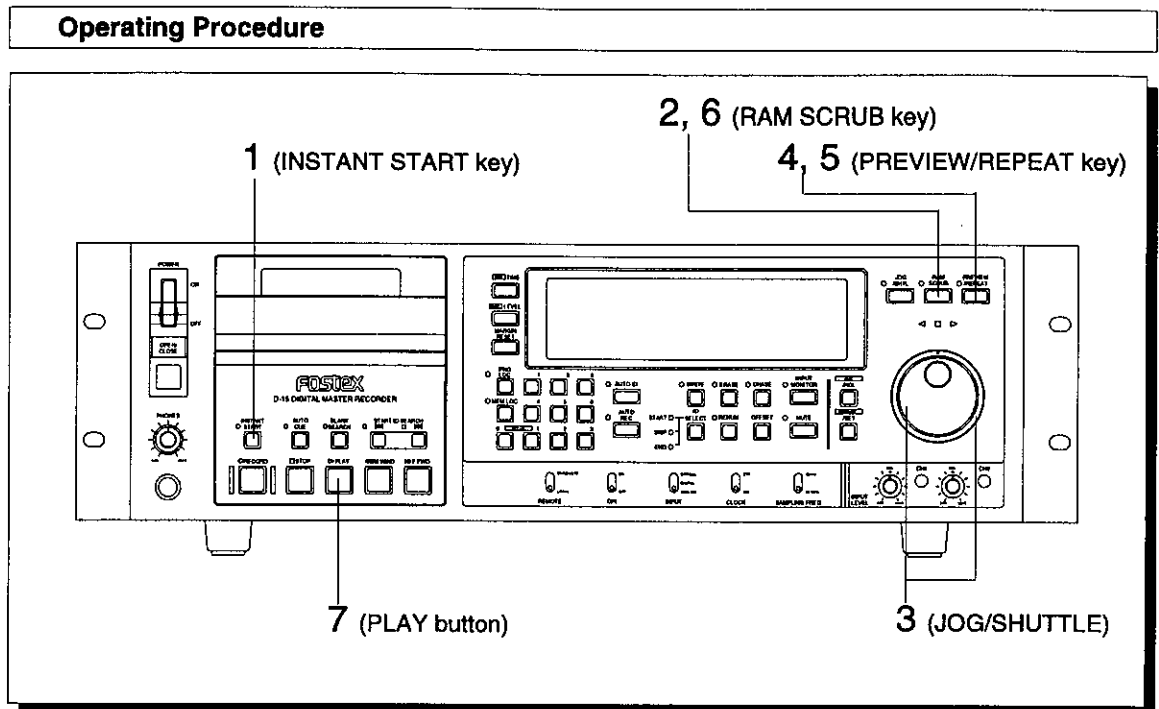

1. Press the [INSTANT START] key to switch "ON" the INSTANT START mode.
2. Press the [RAM SCRUB] key ([RAM SCRUB] key LED will change from blinking to lighting).
 - * If the [RAM SCRUB] key is pressed once more while the [RAM SCRUB] key LED is lit, audio data for ± 1.5 seconds centered around the point where the key was pressed can be newly recorded in the RAM.
3. Move the start point by manipulating the [JOG]/[SHUTTLE] dials.
4. Press the [PREVIEW/REPEAT] key.
Playback is started for about two seconds from the newly changed start point (rehearsal).
5. If rehearsal is to be repeated once more, press the [PREVIEW/REPEAT] key again.
6. If the start point must be moved again, use RAM SCRUB and repeat above steps 1 ~ 5.
7. After finishing rehearsal, press the [PLAY] button to execute INSTANT START.

4-8-4. Trimming of INSTANT START via the [PREVIEW/REPEAT] key

Repeated rehearsal is possible by moving the instant start point in 0.03 frame units using the [PREVIEW/REPEAT] key.

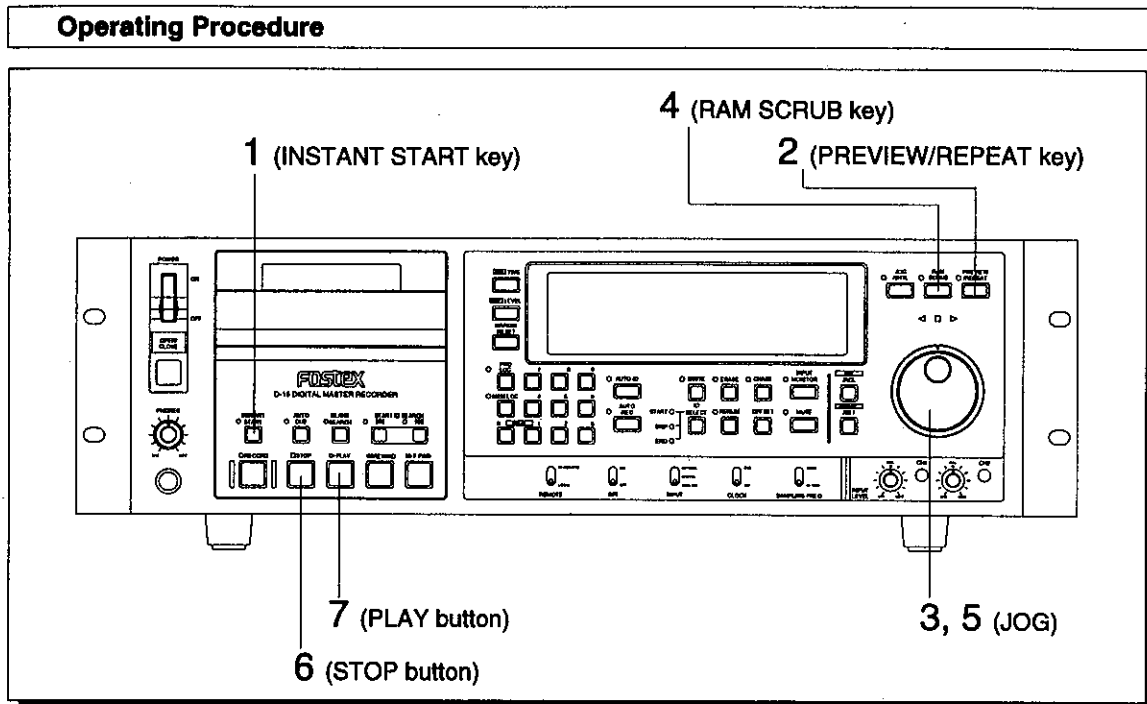

1. Press the [INSTANT START] key to switch "ON" the INSTANT START mode.
2. Press twice the [PREVIEW/REPEAT] key (the PREVIEW/REPEAT key LED will be lit).
It will enter the RAM REPEAT mode and using the point where the key was pressed as the start point, RAM playback will be repeated for about 2 seconds.
3. Using the [JOG] dial, this start point is moved in 0.03 frame units to setup a new start point.
4. When the trimming area is lacking in area, press the [RAM SCRUB] key twice in succession.
Centered around the start point thus moved, AUDIO DATA for 1.5 seconds each before and after this point will be recorded in the RAM.

<NOTE>
Proceed to the next operation after the RAM SCRUB LED and INSTANT START LED changes from blinking to steady lighting.

5. Using the new AUDIO DATA thus recorded, execute steps 2 and 3 to reinstall the start point.
6. After setting the start point by rehearsal, press the [STOP] button to cancel the RAM REPEAT mode.
It will wait (PAUSE) at the newly setup start point.
7. Press the [PLAY] button after completing the rehearsal.
INSTANT START can now be executed from the newly set start point.

4-8-5. Locating Using INSTANT START

When the locate function such as S-ID search or P NO locate is carried out in the INSTANT START mode, INSTANT START will be executed from the searched or located point upon completion of search/locate.

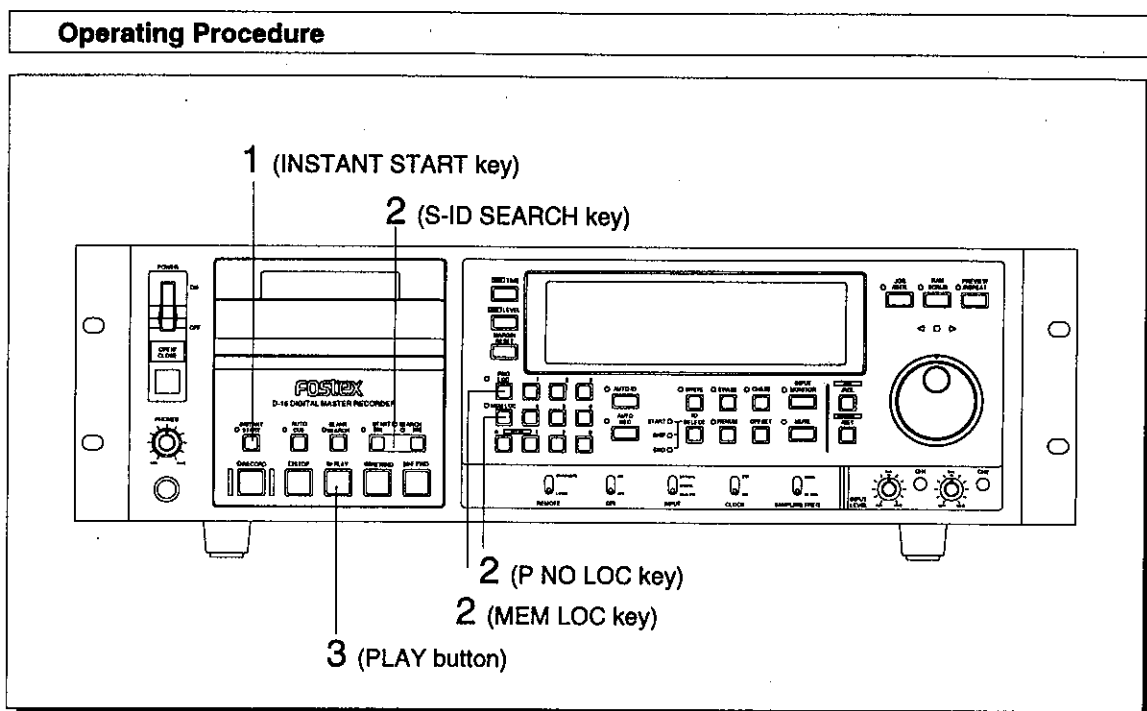

1. Press the [INSTANT START] key to switch "ON" the INSTANT START mode (INSTANT START LED will change from blinking to a constant light).

2. Start searching or locating.

Upon completing the search or locating, AUDIO DATA in vicinity of the locate point will be recorded in the RAM and INSTANT START will standby (PAUSE).

◆ Refer to page [60] "SEARCH/LOCATE operation" for explanation on the search/locate method.

3. Press the [PLAY] button.

INSTANT START will be executed.

If the PLAY button is pressed during execution of the above search/locating operation, INSTANT START is automatically executed from the locate point.

There is a difference in operating manner between search/locate, in the normal mode and in the INSTANT START mode.

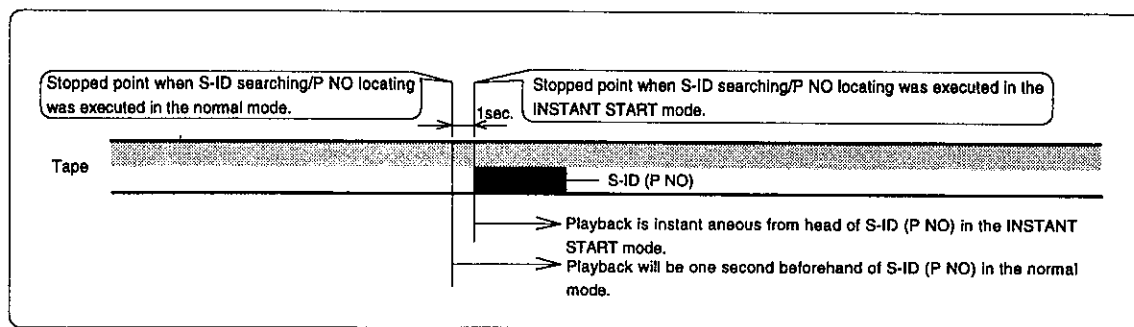

4-9. The AUTO CUE Mode

AUTO CUE is the function of automatically finding the "sound rise up point (*)" from the no-sound state located near the S-ID recorded on the tape, as shown in schematic below, and which make INSTANT START possible from this sound rise up point.

** Sound rise up point **

After continuation of a no sound recorded section for a certain length of time, the section recorded with a signal higher in level than standard is called the "sound rise up point."

At leaving the plant, the initial setting is 900msec. for the no sound recording time and -40dB for the standard level but these figures can be changed by the SET UP mode "201-***."

* Refer to page [106] for details on SET UP mode "201-***."

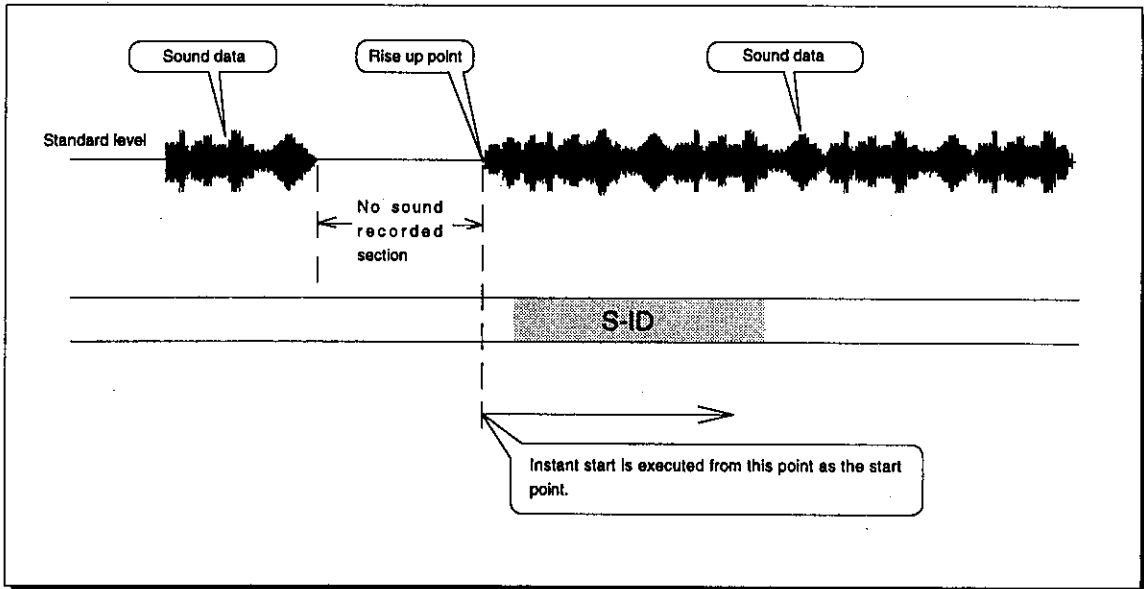

4-9-1. S-ID Search/P-NO Locate in the AUTO CUE Mode

If S-ID search or P NO locate is executed by using the AUTO CUE mode, the sound rise-up point near the S-ID is searched. It is then possible to INSTANT START from this point. Simultaneous with switch ON of the AUTO CUE key, the INSTANT START mode will also switch ON.

Operating Procedure

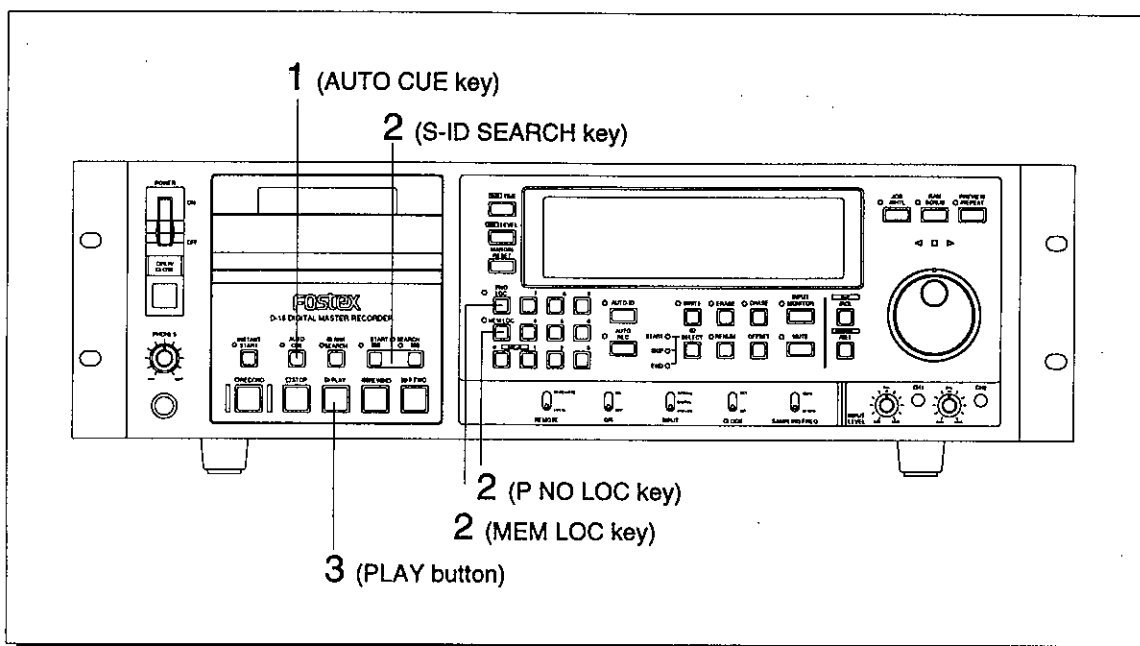

1. Press the [AUTO CUE] key to switch "ON" the AUTO CUE mode (AUTO CUE LED will be lit).
In this case, INSTANT START mode is simultaneously switched "ON" and the INSTANT START LED changes from blinking to a constant light.
2. Execute S-ID search or P NO locate.
After completing search or locating, search the sound rise up point in vicinity of the S-ID, load AUDIO DATA near this point in the RAM and INSTANT START will be in standby (INSTANT START LED will change from blinking to a constant light).

◆ Refer to page [60] "Search/Locate" for details on the search/locate operation.

3. After checking that the [INSTANT START] key LED is lit, press the [PLAY] button.
Execute INSTANT START from the sound rise up point in vicinity of the S-ID which had been searched or located. If the PLAY button is pressed during execution of search or locate, playback is started automatically from that point after completing search/locating.

Press either the [AUTO CUE] or [INSTANT START] keys to cancel the AUTO CUE mode. The AUTO CUE mode only will be switched "OFF" when the AUTO CUE key is pressed, and both the AUTO CUE mode and INSTANT START mode will be switched "OFF" when the [INSTANT START] key is pressed.

4-9-2. When Tape is Loaded in the AUTO CUE Mode

When tape is loaded in the AUTO CUE mode, if there is an S-ID near where the tape is loaded, INSTANT START will be possible from the sound rise-up point located near the S-ID.

If no S-ID is found, the recorder will PAUSE and standby for INSTANT START from the loaded position.

< NOTE >

If the recorder is loaded in a non-recorded section, blank search will not be carried out but the recorder will PAUSE in the loaded position.

Chapter 5. Record/Erase of Sub ID

In this chapter are explained, operating methods on record/erase of various sub ID's such as start ID (S-ID), program number (P NO), skip ID (SKIP-ID), end ID (END-ID), etc. which are indispensable as DAT functions.

As explained in "Preliminary Notes," page [41], Chapter 3, various ID's, namely S-ID, P NO, SKIP-ID, END-ID can be recorded/erased in the D-15.

< NOTE >

It is necessary for A-TIME to be recorded on the tape if recording of the Sub-ID by later recording or renumbering is to be carried out.

< NOTE >

Record/erase of Sub-ID cannot be executed if the cassette tape record prevention hole is open.

Chapter 5. Table of Contents

5-1. Record/Erase of Start ID/Program No.....	74
5-1-1. Automatic Recording of S-ID/P NO During Recording.....	74
5-1-2. Record of S-ID/P NO at a Random Point During Recording.....	75
5-1-3. Recording of new S-ID/P NO During Playback of a Prerecorded Tape.....	76
5-1-4. Automatic Recording of S-ID/P NO During the Manual or Automatic Recording Operation.....	78
5-1-5. Re-recording a Continuous P NO (renumbering function) from the Head of the Tape.....	79
5-1-6. Erasing the S-ID/P NO.....	80
5-2. Record/Erase of SKIP-ID.....	82
5-2-1. Recording of SKIP-ID an Any Point During a Recording.....	82
5-2-2. After Rehearsal, Record SKIP-ID During Playback of a Prerecorded Tape.....	83
5-2-3. Erasing the SKIP-ID.....	84
5-3. Record/Erase of END-ID.....	85
5-3-1. Record the END-ID at Any Position During a Recording.....	85
5-3-2. Do Rehearsal, then Record END-ID During Playback of a Prerecorded Tape.....	86
5-3-3. Erasing the END-ID.....	88

5-1. Record/Erase of Start ID/Program No.

Procedures in recording the Start ID and P-NO will be explained in the following.
The D-15 can record a S-ID via the following 5 methods:

1. Automatic recording of S-ID/P-NO while in the recording mode.
2. Record a S-ID/P-NO in any desired point while in the recording mode.
3. During playback, S-ID/P NO must be recorded by minutely adjusting the recording point while rehearsing.
4. Record S-ID/P NO automatically during the recording operation.
5. After locating the head of a prerecorded tape via cueing, record S-ID/P-No. in that position.

5-1-1. Automatic Recording of S-ID/P-NO During a Recording

In this procedure, S-ID/P NO can be automatically recorded in match with the input signal using the D-15 AUTO-ID mode.

This will function by any one of ANALOG IN, AES/EBU or OPTICAL IN. Also, in the AUTO-ID mode, S-ID/P NO will be recorded by LEVEL detection. However, at recording by OPTICAL IN, even though AUTO-ID mode is OFF, S-ID recorded in the input source side will be directly recorded automatically. Therefore, it is recommended to set AUTO-ID to OFF if S-ID recorded in the source side is to be directly recorded.

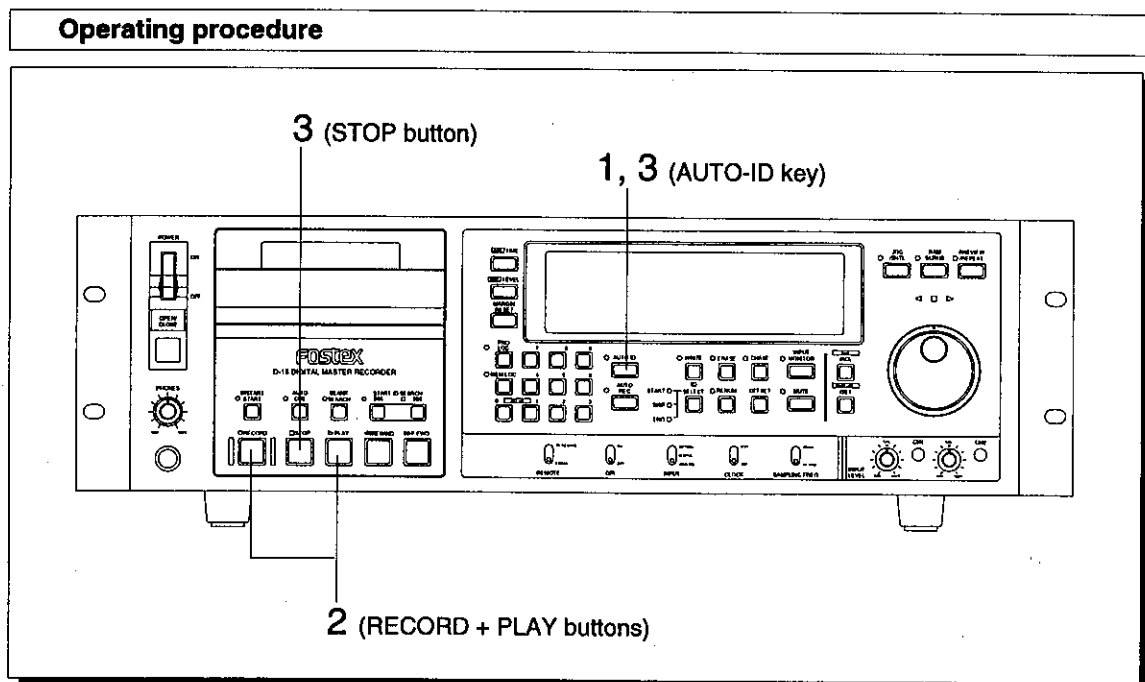

1. Press the [AUTO-ID] key ([AUTO-ID] LED will light) before starting to record.
It will enter the AUTO-ID mode.
2. While pressing the [RECORD] button, press the [PLAY] button to start recording.
After more than a certain length of time () of no sound is recorded, and when a higher than the reference level (*) signal is input, S-ID will be recorded automatically at that point.*
During recording of the S-ID, [S-ID] will be lighted in the display and, at the same time, LED for the [WRITE] key and START LED for the [ID SELECT] key will be lit but they will be extinguished simultaneous with completing recording of the S-ID.

(*) Constant time of no sound recording in the AUTO-ID mode and reference level of the input signal can be set by the SETUP mode. Initial setup figures are 900msec for no sound recording time and -40dB for the input reference level.

Refer to page **, "Chapter 7 The SETUP mode" for setting the no sound recording time and input reference level.

* If a P NO is already shown in the [PGM] display at the start of the recording, P NO's automatically counted up from this will be recorded.

Also, if a new number is specified from the numerical keypad in the [NEXT] display section, this specified number will be recorded as the program number.

* P NO "001" will be recorded when [---] is shown in the [PGM] display.

3. Press the [AUTO-ID] key to switch it "OFF" upon finishing recording (AUTO-ID key LED will be extinguished).

5-1-2. Record of S-ID/P-NO at a Random Point During a Recording

In this chapter, S-ID/P-NO will be manually recorded at a random point during a recording.

Operating procedure

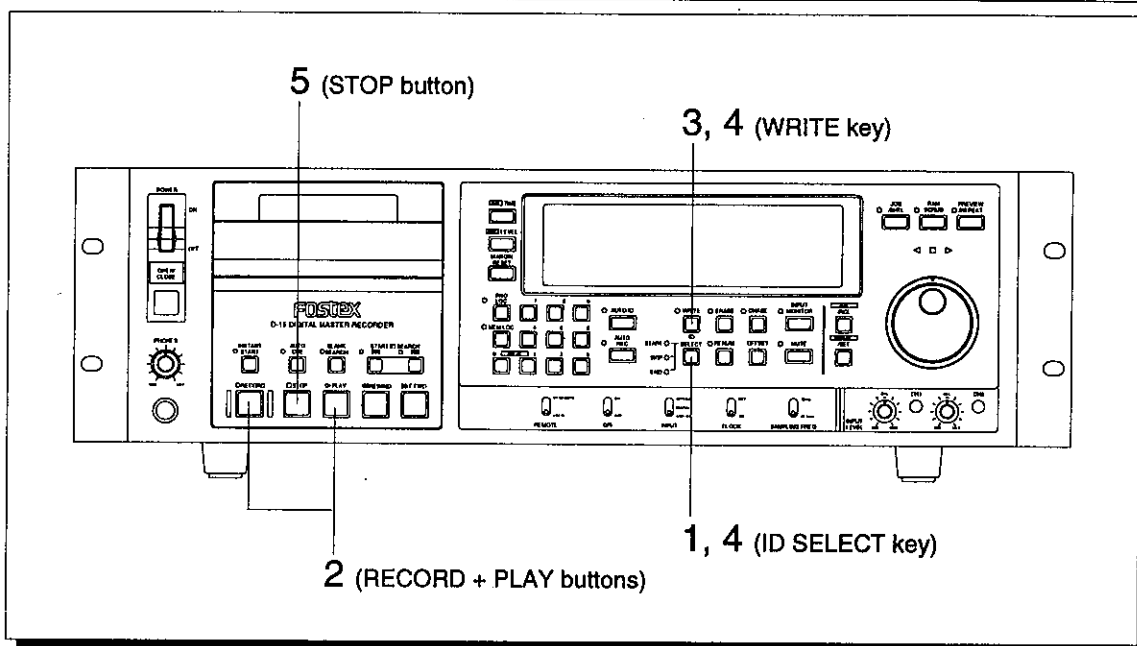

1. Before start of the recording, press the [ID SELECT] key to light the START LED (Although it is in the AUTO-ID mode, the AUTO-ID mode will switch OFF at the same time the [ID SELECT] key is pressed).
Sub ID which can be recorded will be selected into "S-ID."
2. While pressing the [RECORD] button, press the [PLAY] button to start recording.
3. Press the [WRITE] key upon arriving at the point where S-ID is to be recorded.
*S-ID will be recorded at the point where the [WRITE] key was pressed.
[S-ID] will be shown in the display during recording of S-ID and be extinguished at finish of recording.*

At the same time, START LED of the [ID SELECT] key will be extinguished.

4. In order to record S-ID again at a different point, press the [ID SELECT] key once again to light the START LED, then press the [WRITE] key. Subsequently, in order to record S-ID at a random point, always light the START LED with the [ID SELECT] key, then press the [WRITE] key.
5. Upon finishing recording, press the [STOP] button to stop D-15.

* If a program number is already shown in the [PGM] display section at the start of the recording, program number's automatically counted up from this will be recorded.
 If a new number is specified from the numerical keypad in the [NEXT] display section, this number will be recorded as the program number.

* P-NO *001* will be recorded if [---] is shown in the [PGM] display.

5-1-3. Recording of new S-ID/P-NO During Playback of a Prerecorded Tape

In the following, S-ID/P-NO is recorded at random points while playing back a prerecorded tape. In this process, minute adjustments are made by the RAM REPEAT rehearsal mode for accurate positioning where S-ID/P-NO are to be recorded.

< NOTE 1 >
 This process cannot be executed if A-TIME is not recorded on the tape.

< NOTE 2 >
 This will not operate if the cassette tape erase prevention hole is open.

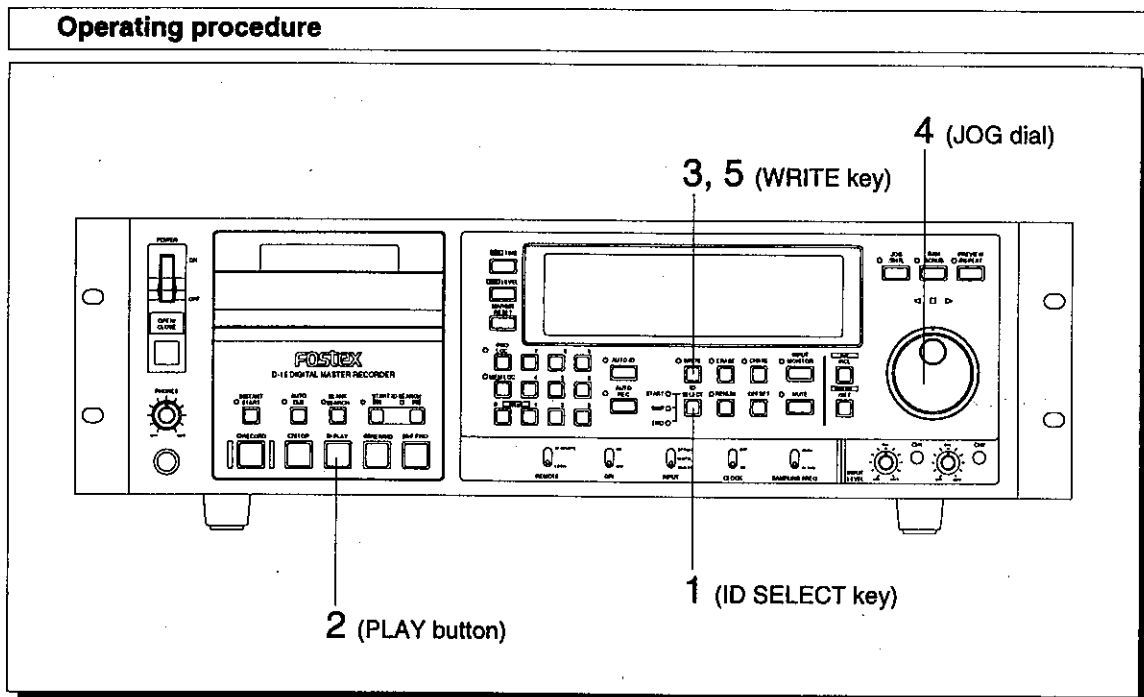

1. Prior to playback, press the [ID SELECT] key to light the START LED.
2. Start playback by pressing the [PLAY] button.

3. Press the **[WRITE]** key once upon reaching the point where an S-ID/P-NO is to be recorded.

Simultaneous with pressing this key, it will enter the INSTANT START mode, and simultaneous with blinking of the WRITE key LED, RAM REPEAT playback (rehearsal) will be repeated for about one second from the instant this key was pressed (The time at which this key was pressed will be displayed).

* During this condition, if the **[WRITE]** key is successively pressed, an S-ID can be recorded without rehearsal. At this point, if rehearsal is to be interrupted, press the STOP button.

4. Change to the address for recording by manipulating the **[JOG]** dial.
The address can be changed in frame units.
 5. After completing rehearsal, an S-ID can be recorded if the **[WRITE]** key is pressed again.
During recording of S-ID, WRITE LED will change from blinking to lighting and [S-ID] is shown in the display.
Simultaneous with finish of recording, START-ID LED of the [ID SELECT] key and the WRITE LED will be extinguished and D-15 will PAUSE.
- * To do this at another point, repeat steps 1~5.

* If a program number is already shown in the [PGM] display section at the start of the recording, program number's automatically counted up from this will be recorded. If a new number is specified from the numerical keypad in the [NEXT] display section, this number will be recorded as the program number.

* P-NO "001" will be recorded if [---] is shown in the [PGM] display.

5-1-4. Automatic Recording of S-ID/P NO During the Manual or Automatic Recording Operation

In this case, when recording is started manually, or if entered in automatic recording by the AUTO REC mode, D-15 will enter the recording mode and, at the same time, record S-ID/P NO.

ON/OFF of this function can be set by the D-15 SETUP mode "106 -***."
Initial setting at leaving the plant is [Function "ON"].

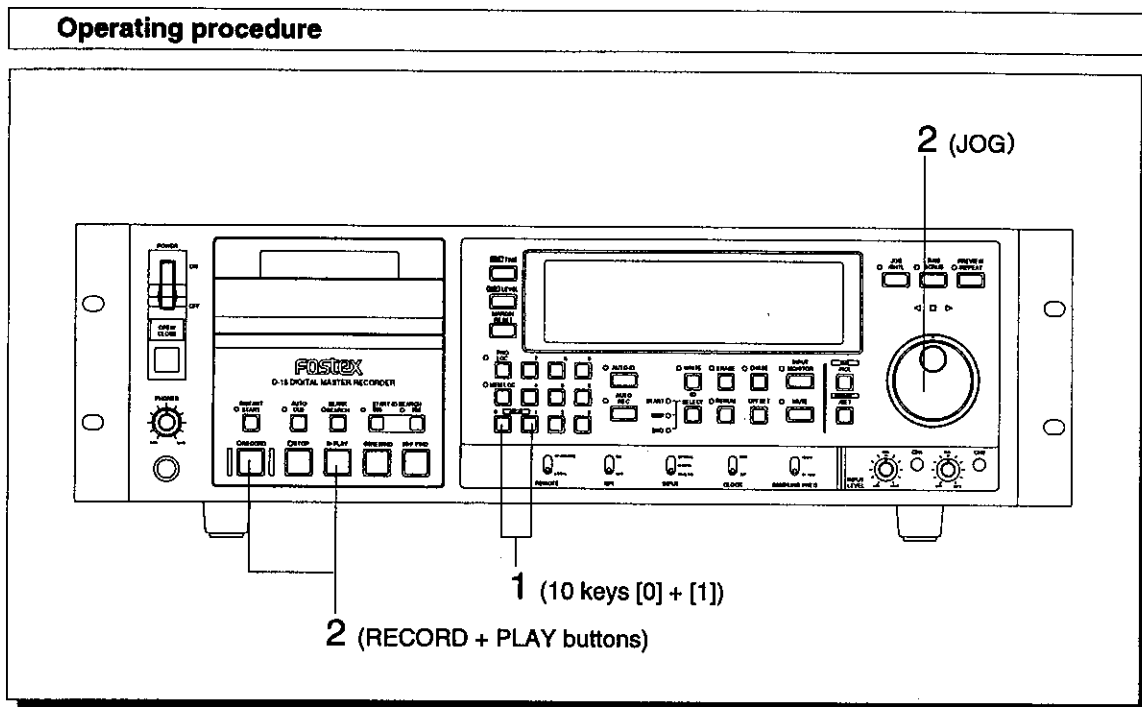

1. Enter the SETUP mode by pressing the numerical keypad [0] and [1] at the same time.
2. Select the SETUP menu of "106 -***" with the [JOG] dial to check that it is setup to function "ON (001)."
If it is setup to "OFF (000)," refer to page [103] and set it to "ON (001)."
3. Start recording by pressing the [PLAY] button while pressing the [RECORD] button.
Simultaneous with entering the recording mode, S-ID/P NO will also be recorded.
In the AUTO REC mode, not only will the recording mode be entered at the memory [00] point but S-ID/P NO will also be recorded at that point.

* If a program number is already shown in the [PGM] display section at the start of the recording, program number's automatically counted up from this will be recorded.
If a new number is specified from the numerical keypad in the [NEXT] display section, this number will be recorded as the program number.

* P-NO "001" will be recorded if [---] is shown in the [PGM] display.

<NOTE 1>

If S-ID/P NO need not be recorded from the point where recording is started, change the SETUP mode "106 -***" to "OFF."

<NOTE 2>

S-ID/P NO will not be recorded automatically even though recording operation is carried out at head of tape (BOT section).

5-1-5. Re-recording a Continuous P NO (renumbering function) from the Head of the Tape

If the continuity of P NO has been disturbed by editing, etc. or an S-ID only is recorded and a P NO not recorded, a continuous P NO can be re-recorded (renumbered) from head of tape.

This process can be executed at any position of the tape.

< NOTE 1 >

This process cannot be executed if no A-TIME is recorded on the tape.

< NOTE 2 >

When renumbering S-ID in the vicinity of 0 ~ 10 seconds of A-TIME, its position could drift away when renumbered and the A-TIME continuity could be lost. Therefore, it is recommended that S-ID be recorded 10 seconds after the first program or, in considering the reliability of the tape, after elapse of one minute.

< NOTE 3 >

This will not operate in the INSTANT START mode.

< NOTE 4 >

Renumbering is not possible if the cassette tape erase prevention hole is open.

< NOTE 5 >

If an END-ID is recorded midway of the tape, it cannot be renumbered beyond it.

Operating procedure

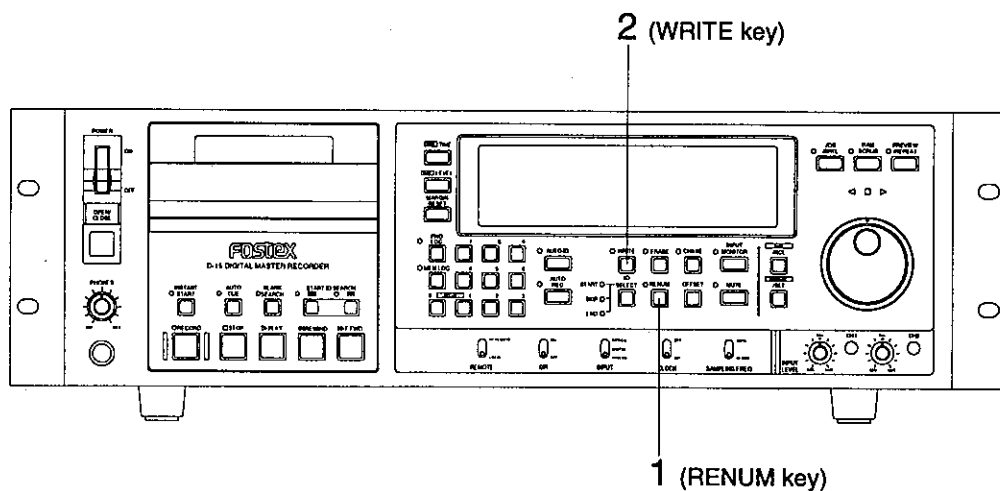

D-15 Owner's Manual (Chapter 5 Record/Erase of Sub-ID)

1. Press the [RENUM] key while the transport is stopped or in pause.
The [RENUM] LED is lit and will standby for renumbering.
2. Then, press the [WRITE] key.
If tape is located at the BOT position, renumbering will start automatically from head of the S-ID.
If tape is at tape end or midway, it will start rewinding to the BOT position simultaneous with pressing the [WRITE] key, then automatically execute renumbering from head of S-ID after completing the rewind.

During the S-ID renumbering function, the following operation is repeated.

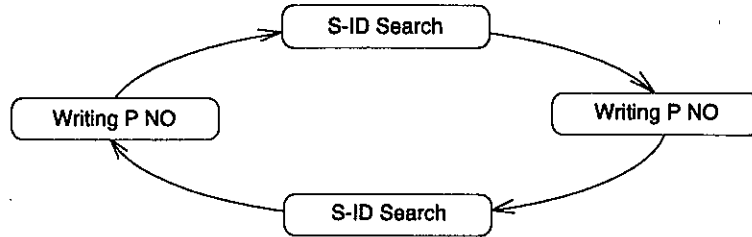

Upon completion of renumbering, tape is automatically rewound and PAUSED at the BOT position.

5-1-6. Erasing the S-ID/P-NO

Unnecessary S-ID/P-NO can be erased.
This process is executed with the transport in the STOP or PAUSE mode.

< NOTE 1 >
This will not operate in the INSTANT START mode.

< NOTE 2 >
ERASE cannot be executed with the cassette tape erase prevention hole open.

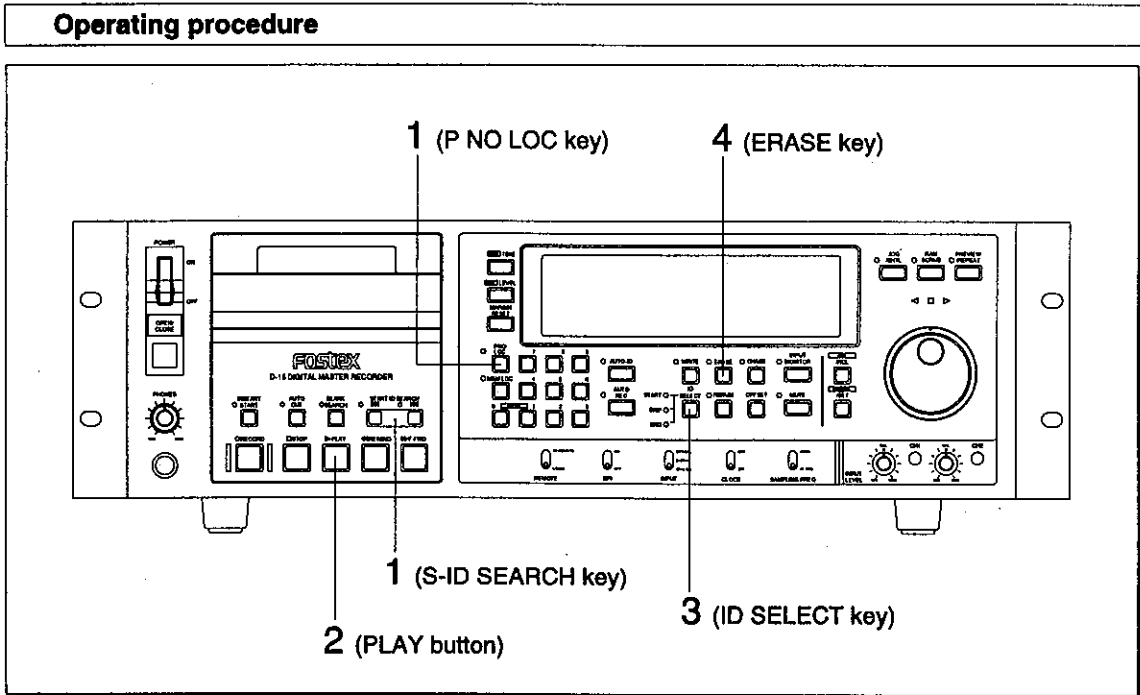

D-15 Owner's Manual (Chapter 5 Record/Erase of Sub-ID)

1. Find the S-ID to be erased.

Use either one of the following methods to find the unnecessary S-ID.

* Press the [ID SEARCH <<>>] key to find the desired S-ID.

* Use the [P NO LOC] key to find the desired S-ID.

2. After finishing search or locate, press the [PLAY] button and stop it at the position where [S-ID] is lit in the display.

3. Press the [ID SELECT] key and select "START" ([START] LED will be lit).

4. Press the [ERASE] key after confirming that [S-ID] is displayed.

When the key is pressed, S-ID/P NO at the point where the transport is stopped will be searched and erased.

The ERASE LED will be lit during execution of erase and be extinguished upon completion.

- * When an unwanted S-ID/P NO is erased, it is recommended to straighten out the P NO by using the renumbering function.

5-2. Record/Erase of SKIP-ID

Record/erase of SKIP-ID is explained here.

There are the following two methods in recording of SKIP-ID by D-15.

- 1. Record a SKIP-ID in any position during the recording process.
- 2. During playback of a prerecorded tape, conduct a rehearsal (RAM REPEAT playback) to minutely adjust the record point, then record the SKIP-ID.

5-2-1. Recording of SKIP-ID at Any Point During a Recording

In this chapter, SKIP-ID is manually recorded at any position during recording of AUDIO DATA.

< NOTE >

Recording is not possible if the cassette tape erase prevention hole is open.

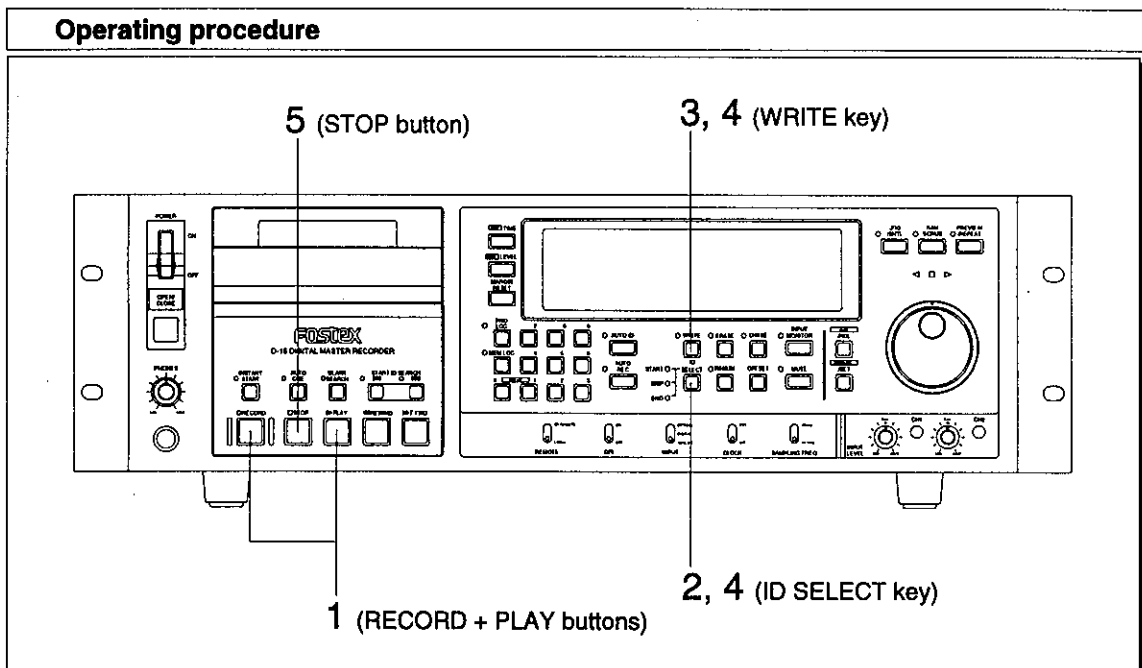

1. Prior to starting to record, press the [ID SELECT] key and select "SKIP" (SKIP LED is lit).

<NOTE>

Should recording be carried out with the SETUP mode "106 - **** rECid remaining switched "ON," S-ID will be recorded at the point where automatic recording was executed. If S-ID is not to be recorded at this point, the SETUP mode "106 - ****" setting must be switched "OFF" before starting to record.

2. While pressing the [RECORD] button, press the [PLAY] button to start recording.
3. Press the [WRITE] key upon arriving at the point where Skip-ID is to be recorded.

Skip-ID is recorded at the point where the [WRITE] key is pressed.

[SKIP-ID] will be shown in the display during recording of the SKIP-ID and be extinguished at finish of recording.

Also, SKIP LED of the [ID SELECT] key will be extinguished at the same time.

4. Successively, to record SKIP-ID at a different position, select SKIP by the [ID SELECT] key, then press the [WRITE] key.
5. Press the [STOP] button at finish of recording to stop D-15.

5-2-2. After Rehearsal, Record SKIP-ID During Playback of a Prerecorded Tape

SKIP-ID is recorded at any position during playback of a prerecorded tape. In this operation, the position where SKIP-ID is to be recorded is minutely adjusted by rehearsal of RAM REPEAT for recording in an accurate position.

< NOTE 1 >

This process cannot be executed if no A-TIME is recorded on the tape.

< NOTE 2 >

If SKIP-ID already exists in the vicinity where recording is to be made, erase this SKIP-ID prior to operation.

< NOTE 3 >

It will not operate if the cassette tape erase prevention hole is open.

< NOTE 4 >

It will not operate if tape is played back in the INSTANT START mode.

Operating procedure

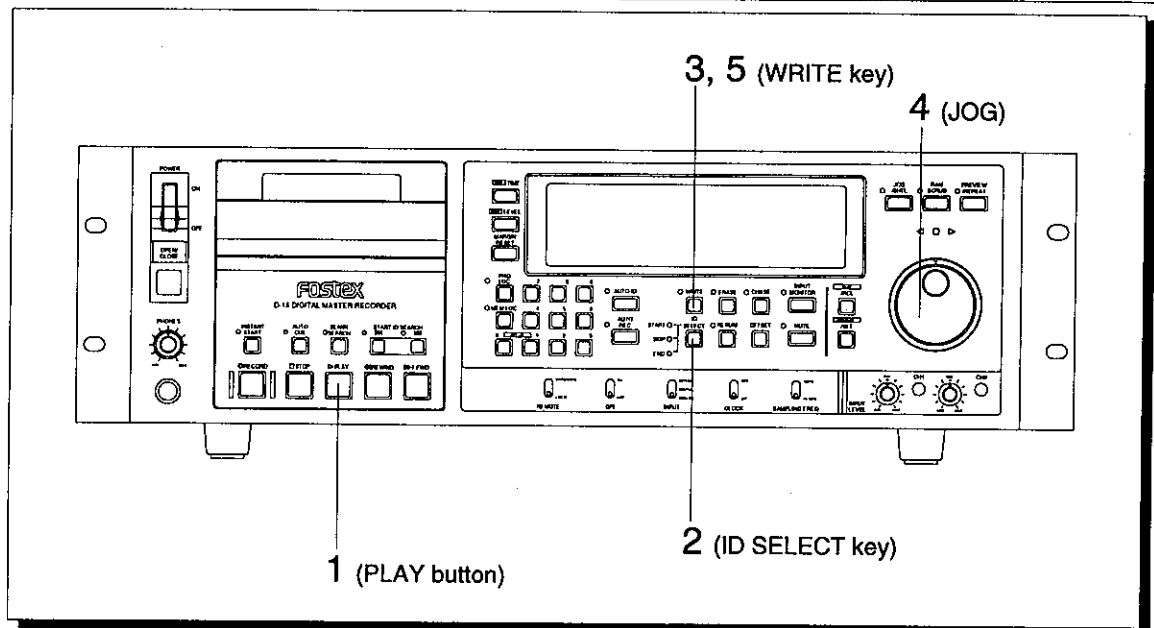

1. Prior to playback, press the [ID SELECT] key and select "SKIP" (SKIP LED will be lit).
2. Start playback by pressing the [PLAY] button.
3. Press the [WRITE] key once when the tape arrives at the position where the SKIP-ID is to be recorded.
It will enter the INSTANT START mode at the instant this key is pressed and simultaneous with blinking of the [WRITE] key LED, RAM REPEAT playback (rehearsal)

D-15 Owner's Manual (Chapter 5 Record/Erase of Sub-ID)

- will be repeated for about one second from the time when the key was pressed (The display, at this moment, will show the time at which the key was pressed).
 - * If the [WRITE] key is subsequently pressed, SKIP-ID will be recorded without rehearsal. Also, if rehearsal is to be interrupted at this point, press the [STOP] button.
4. Change to the address to be recorded with the [JOG] dial.
 5. After completing rehearsal, a SKIP-ID can be recorded if the [WRITE] key is pressed again.
*During recording of SKIP-ID, the WRITE LED will change from blinking to constant lighting and [SKIP-ID] will be shown in the display.
Simultaneously with finish of the recording, the SKIP LED of the [ID SELECT] key and the WRITE LED will be extinguished and D-15 will PAUSE.*
- * If recording is to be carried out again at a different point, repeat steps 1~5.

5-2-3. Erasing the SKIP-ID

Unnecessary SKIP-ID's can be erased.

< NOTE 1 >

This will not operate in the INSTANT START mode.

< NOTE 2 >

This will not operate if the cassette tape erase prevention hole is open.

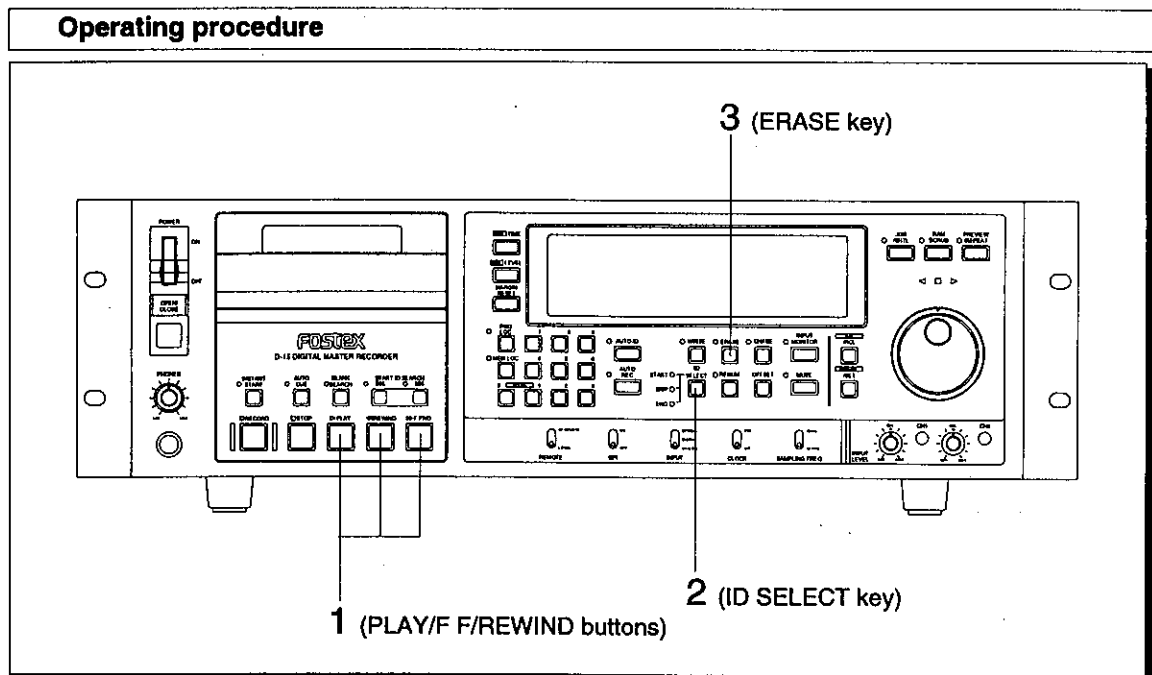

1. Find the SKIP-ID to be erased by playback, fast forward or rewind modes and show it in the [SKIP-ID] display.
2. Press the [ID SELECT] key and select SKIP (SKIP LED will be lit).

3. Confirm that [SKIP-ID] is shown in the display and press the [ERASE] key. When the key is pressed, the transport will search for the SKIP-ID located within 9 seconds (300 frames) from the stopped position and erase it.

5-3. Record/Erase of END-ID

Record/Erase of the END-ID is explained here.

Same as for SKIP-ID, recording of the END-ID by D-15 is possible in the following two methods:

1. Record END-ID at any position during recording.
2. During playback of a prerecorded tape, make minute adjustments in the rehearsal (RAM REPEAT playback) mode and then, record the END-ID.

5-3-1. Record the END-ID at any position during a recording

In this chapter, END-ID is recorded manually at any point during recording of AUDIO DATA.

< NOTE >

Recording is not possible if the cassette tape erase prevention hole is open.

Operating procedure

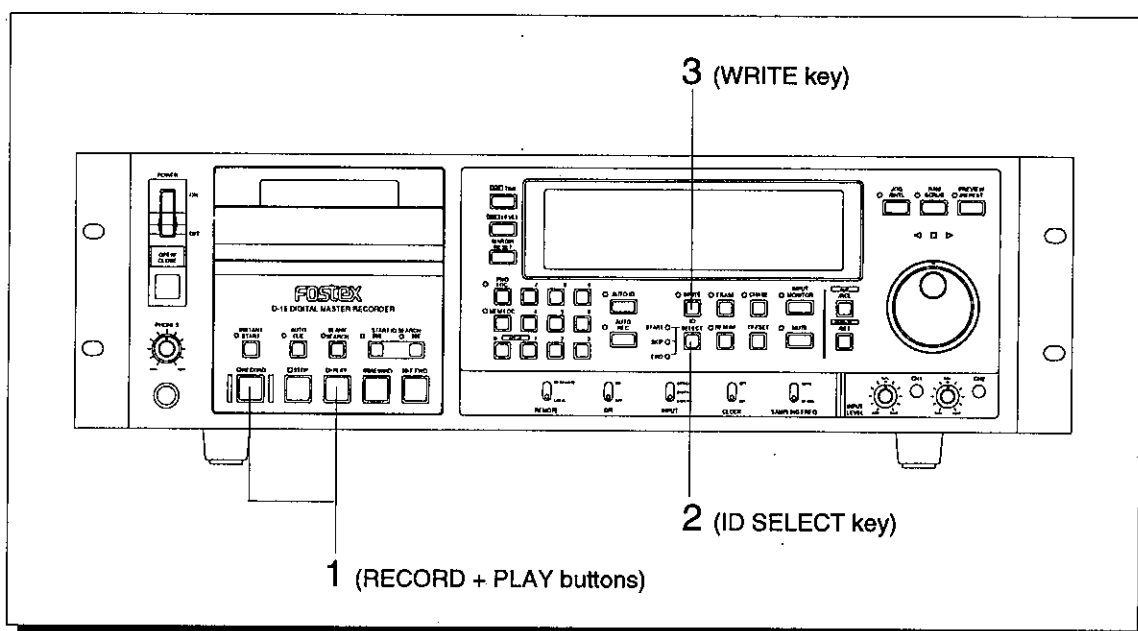

1. While pressing the [RECORD] button, press the [PLAY] button to start recording.

<NOTE>

Should recording be carried out with the SETUP mode "106 - **** rECId remaining switched "ON," S-ID will be recorded at the point where automatic recording was executed. If S-ID is not to be recorded at this point, the SETUP mode "106 - ****" setting must be switched "OFF" before starting to record.

2. Press the [ID SELECT] key and select "END" (END LED is lit) prior to starting the recording.
 3. Press the [WRITE] key when tape arrives at the position where END-ID is to be recorded.
*[END-ID] will be shown in the display during recording of END-ID and be extinguished at finish of recording.
 Also, END LED of the [ID SELECT] key will be extinguished at the same time.*
- * At finish of recording the END-ID, it automatically REWINDS and PAUSE at two seconds before the END-ID.

5-3-2. Do Rehearsal, Then Record END-ID During Playback of a Prerecorded Tape

Here, END-ID is recorded at any position during playback of a prerecorded tape. In this operation, the position where END-ID is to be recorded is minutely adjusted by rehearsal of RAM REPEAT for recording in an accurate position.

< NOTE 1 >
 This process cannot be executed if no A-TIME is recorded on the tape.

< NOTE 2 >
 If END-ID already exists in the vicinity where recording is to be made, erase this END-ID prior to operation.

< NOTE 3 >
 It will not operate if the cassette tape erase prevention hole is open.

< NOTE 4 >
 It will not operate if tape is played back in the INSTANT START mode.

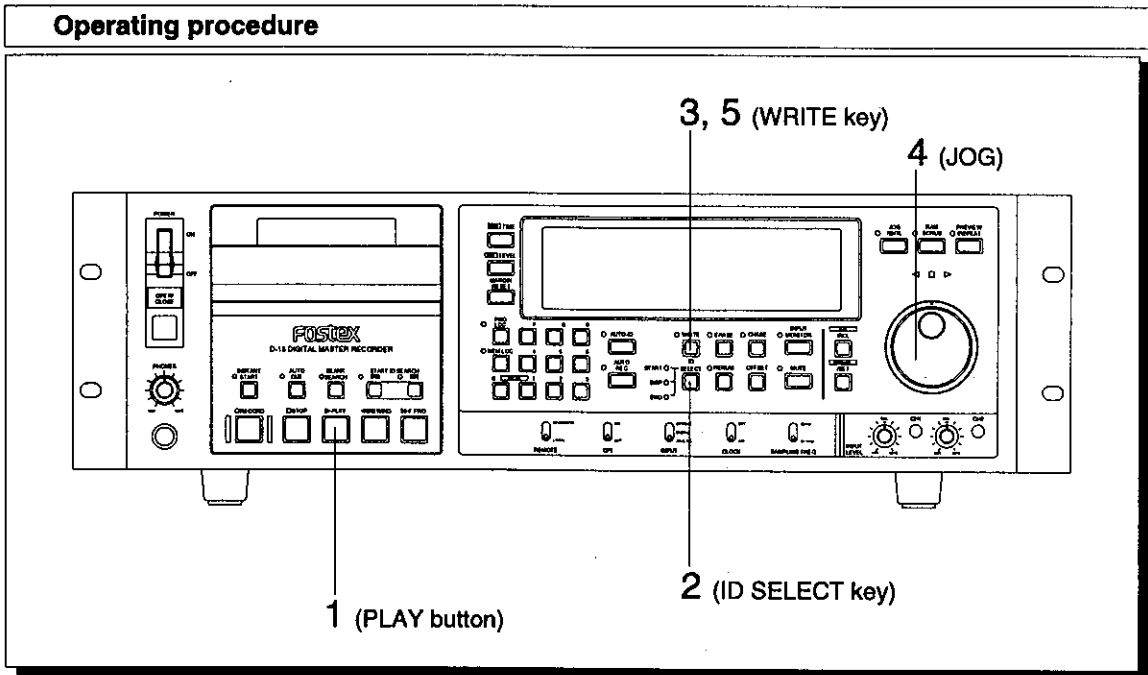

D-15 Owner's Manual (Chapter 5 Record/Erase of Sub-ID)

1. Start playback by pressing the [PLAY] button.
2. Prior to playback, press the [ID SELECT] key and select "END" (END LED will be lit).
3. Press the [WRITE] key once upon arriving at the point where END-ID is to be recorded.
It will enter the INSTANT START mode at the instant this key is pressed and simultaneous with blinking of the [WRITE] key LED, RAM REPEAT playback (rehearsal) will be repeated for about one second from the time when the key was pressed (The display, at this moment, will show the time at which the key was pressed).

* At this point, if the [WRITE] key is pressed twice in succession, END-ID can be recorded without conducting a rehearsal. Also, at this point, if rehearsal is to be interrupted, press the [STOP] button.
4. Change to the address for recording by manipulating the [JOG] dial.
5. After completing rehearsal, an END-ID can be recorded if the [WRITE] key is pressed again.
During recording of the END-ID, WRITE LED will change from blinking to lighting and [END-ID] will be shown in the display.

* At finish of recording the END-ID, it automatically REWINDS and PAUSE at two seconds before the END-ID.

5-3-3. Erasing the END-ID

Unnecessary END-ID's can be erased.

< NOTE 1 >
This will not operate in the INSTANT START mode.

< NOTE 2 >
This will not operate if the cassette tape erase prevention hole is open.

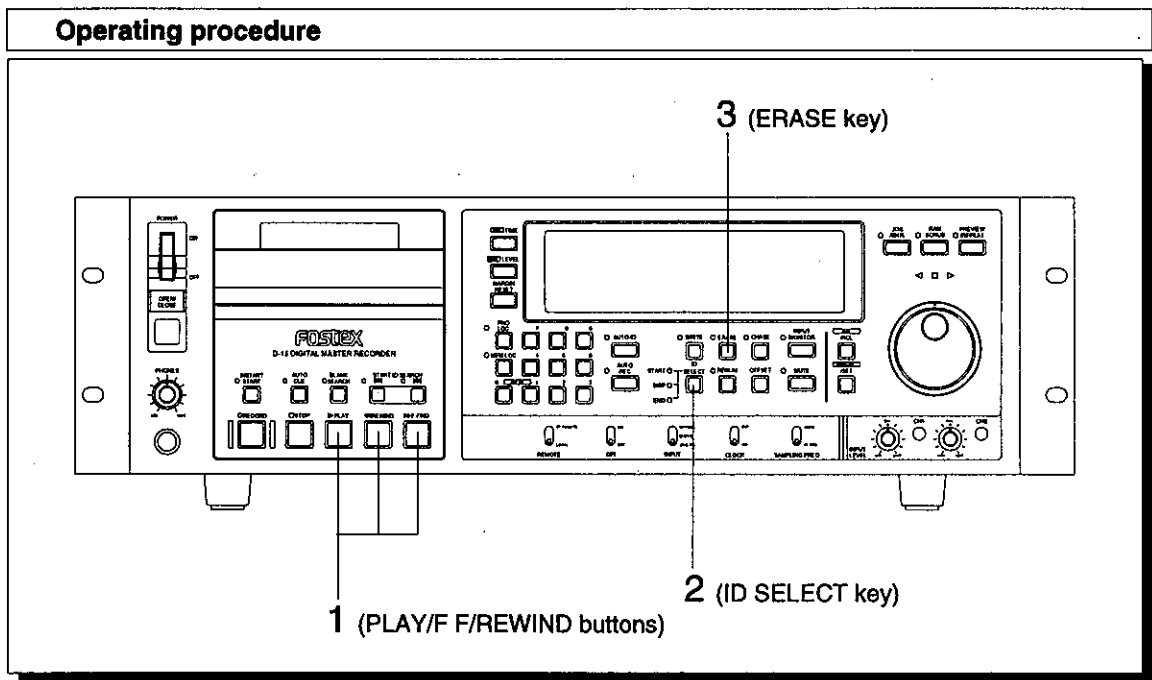

1. Find the END-ID to be erased by playback, fast forward, rewind modes or after BLANK SEARCH, PLAY it to find it and show it in the [END-ID] display.
2. Press the [ID SELECT] key and select "END" (END LED will be lit).
3. Check that [END-ID] is displayed and press the [ERASE] key.
When this key is pressed, the END-ID at present position where the transport is stopped will be searched and erased.
During execution of erase, the ERASE LED is lit but extinguished at finish of erase.

Chapter 6. Memory Edit Mode

The method to edit the memory number and memory information are explained here.

Chapter 6. Table of Contents

6-1. Store/Recall/Editing of Memory Data.....	90
6-1-1. Store in Real Time the Present Time.....	90
6-1-2. Checking (recall) Time Information of the Specified Memory Number.....	91
6-1-3. Editing the Memory Number/Time Data.....	93

6-1. Store / Recall / Editing of Memory Data

When time information of A-TIME is on the display, a random memory number can be specified by the displayed time information and stored in that memory number. 100 memory numbers from [00] to [99] can be setup. The stored memory data can be recalled, then the recalled memory data can be edited and stored again.

* If the optional Model 8335 (TC/SYNC card) is installed, it will be possible to edit TC time in addition to A-TIME and furthermore, the OFFSET time. For details on these, refer to the Model 8335 Owner's Manual.

6-1-1. Store in Real Time the Present Time

The desired time can be stored in real time at a random memory number while the transport is in STOP/PAUSE or running (PLAY/REC-PLAY) modes. For an example here, the method of storing in memory number "07" will be explained.

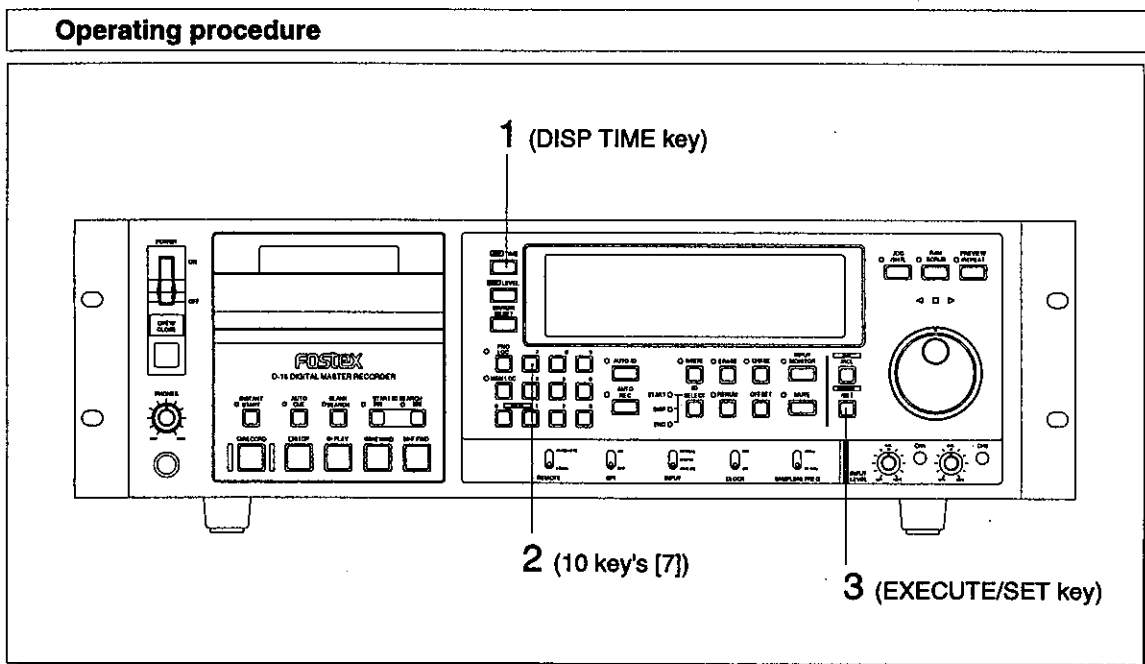

1. Change to A-TIME display by pressing the [DISP TIME] key.
2. Press [7] of the [numerical keypad].
[NEXT] will appear in the display and [007] will be shown below the [NEXT] display.

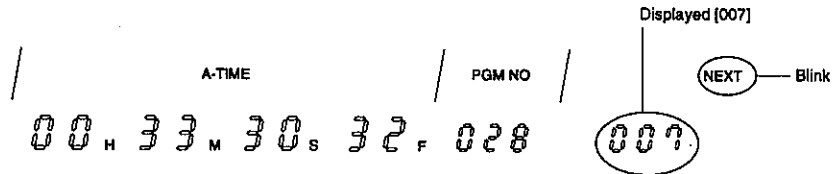

<NOTE>
 Although 3 digits can be input in the [NEXT] display, when storing by pressing the [EXECUTE/SET] key, the upper one digit will be ignored.
 For example, if the numerical keypad is pressed in order of [2], [3] and [4], it will be displayed as [234] in the [NEXT] section but when storing is executed, the memory number will be [34].

3. Next, press the [EXECUTE/SET] key.

Time data at the instant the key was pressed will be stored in memory number [07]. When tape is running, even though [NEXT] is on the display in step 2, time indication will be advancing and therefore, if the [EXECUTE/SET] key is pressed upon reaching the desired time, the time when the key was pressed will be stored in real time.

In this way, the desired time is stored in memory number "07" and the display will return to what it was before the appearance of [NEXT] in the display.

* If storing is to be interrupted prior to pressing the [EXECUTE/SET] key, press the [DISP LEVEL] key. When this key is pressed, the [NEXT] display will change to [MARGIN] on the normal display.

< NOTE >

If the [EXECUTE/SET] key is pressed without any input from the numerical keypad, it will be automatically stored in memory number "00."

6-1-2. Checking (recall) Time Information of the Specified Memory Number

Time information stored in the memory number can be reconfirmed. For example, the previously stored memory number "07" will be recalled.

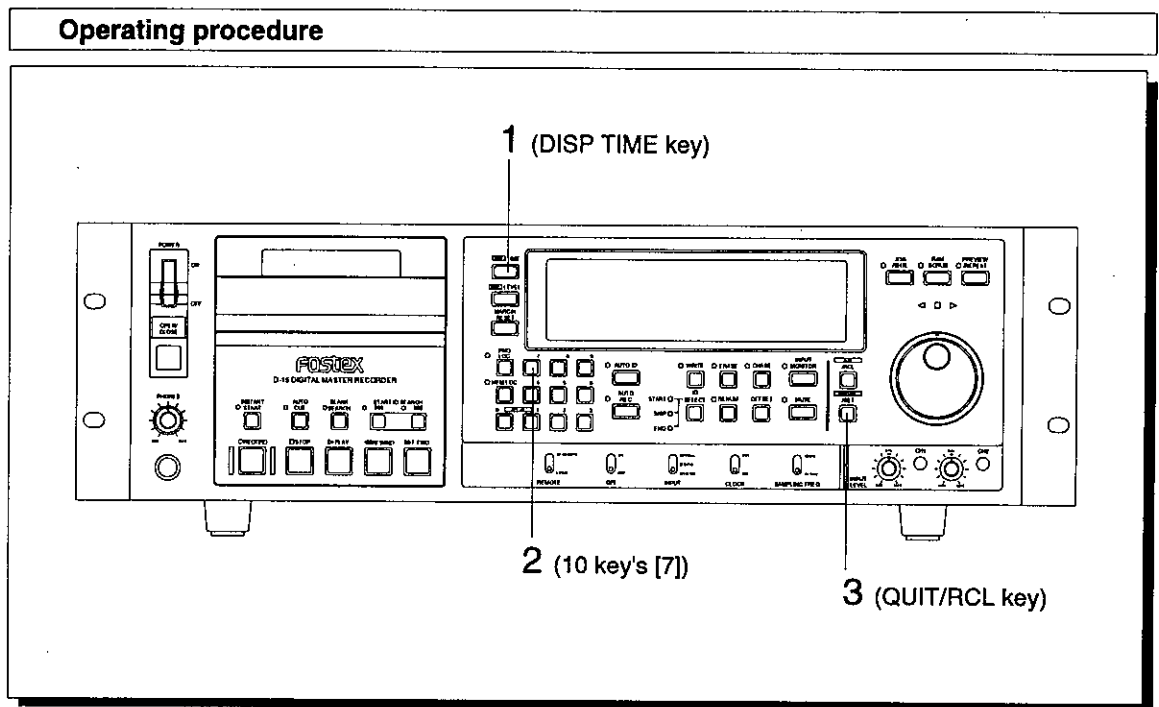

1. Change to A-TIME display by pressing the [DISP TIME] key.

2. Press [7] of the [numerical keypad].

[NEXT] will be displayed when these numbers are input and [007] will be shown below the [NEXT] display.

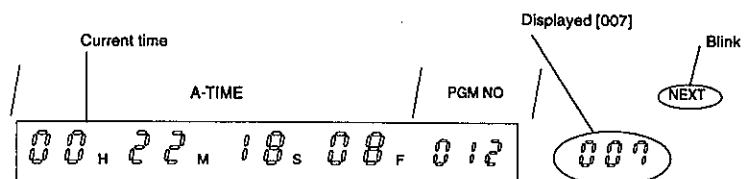

<NOTE>
Although 3 digits can be input in the [NEXT] display, when storing by pressing the [EXECUTE/SET] key, the upper one digit will be ignored.
For example, if the numerical keypad is pressed in order of [2], [3] and [4], it will be displayed as [234] in the [NEXT] section but when storing is executed, the memory number will be [34].

3. Next, press the [QUIT/RCL] key.
When the key is pressed, simultaneous with display of the time information stored in memory number [07], it will change to the memory edit mode display and the memory number [07] time information can be confirmed.

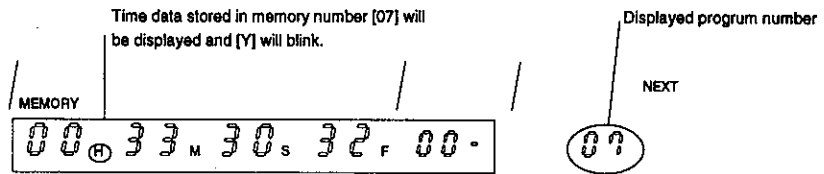

- * If the [QUIT/RCL] key is pressed without input of a number by the numerical keypad, time data of memory number [00] will be recalled.
 - * In order to edit time data already stored, process it in the recalled state. For details on this, refer to the next [6-1-3. Time Data Editing].
4. After recalling, press the [DISP TIME] key to return to the original display.

6-1-3. Editing the Memory Number / Time Data

The previously set memory number or time data can be edited and stored again. As an example here again, time data in memory number [07] will be edited. If another memory number data is to be edited, carry out the following operation.

< NOTE >

When the memory number only is changed, memory number and data stored before this change will remain unchanged and not be renewed.
Also, data originally in this newly stored memory number will be rewritten.

Operating procedure

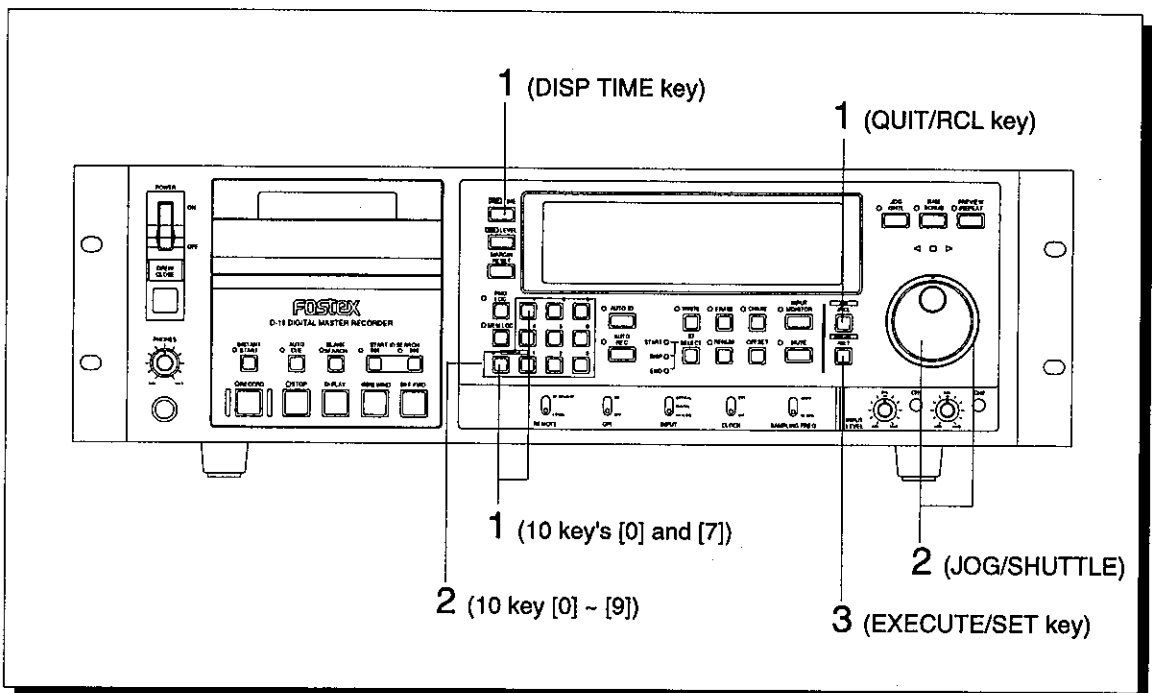

1. Specify the memory number (Example: [07]) to be changed by the same procedures as 1. and 2. in previous 6-1-2 operating procedure and recall the number.

The display will change to the memory edit mode and [H] will blink (this blinking indicates the point whose number can be changed).

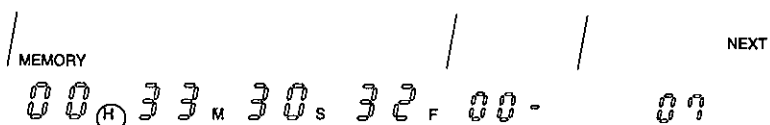

[H] will blink (this blinking indicates the point whose number can be changed).

2. The [SHUTTLE] dial is used to move the digit to be changed and the [JOG] dial or numerical keypad to input numbers.

The digit to be edited will shift in order of [H] -> [M] -> [S] -> [F] -> [NEXT] -> [H] when the [SHUTTLE] dial is rotated clockwise and the order is reversed when rotated counter clockwise.

Numbers can be input as follows by the numerical keypad and the [JOG] dial.

Numerical keypad	After input of two digits, the blinking digit will automatically shift to the right.
JOG dial	The number will increase in clockwise rotation and decrease in counter clockwise rotation. When input in only the [M], [S], [F] digits, the upper digit number will be advanced or retarded (Example: Numbers which can be input in [S] are 00 ~ 59 and when rotated clockwise from 59 and it reaches 00, the number in [M] will be advanced but will be retarded if operated in reverse).

3. After entering the new number, press the [EXECUTE/SET] key to store it.

<NOTE>

When changing the time figure of the digit which can be edited by the numerical keypad, (input and storing of) if a number (*) not effective for the time figure is input and stored, an error message shown below will blink for about one second and return to the memory edit display shown prior to storing. In such a case, input the correct number again and store it.



(*) Numbers effective for the time figure

Numbers effective for time setting are, Hours = 00 ~ 23, Minutes/ Seconds = 00 ~ 59 and Frames = 00 ~ 33. Although numbers other than these can be input for hours, minutes, seconds and frames by the numerical keypad, if storing is attempted the above errors will be shown and it will not be stored.

Chapter 7. The SETUP Mode

The D-15 SETUP mode is explained here.

In the SETUP mode, various settings necessary in using the D-15 can be setup. Although there are some menus which can be displayed by installing the optional Model 8335 (TC/SYNC card) or the Model 8336 (RS-422 interface card: (to be marketed soon) but these menus cannot be displayed unless these optional cards are installed.

Chapter 7. Table of Contents

7-1. The SETUP mode items.....	96
7-2. Procedure for Entering the SETUP mode.....	96
7-3. Executing the SETUP menu.....	99
7-3-1. Confirming the ROM version	99
7-3-2. Setting the reference level.....	100
7-3-3. Setting the SKIP-PLAY mode.....	101
7-3-4. Setting the PAUSE OFF time.....	102
7-3-5. Setting the mode for recording S-ID/P NO into the record starting point.....	103
7-3-6. Setting the panel lock ON/OFF.....	104
7-3-7. Setting the peak hold time.....	105
7-3-8. Setting the cue level for execution of AUTO CUE/AUTO-ID.....	106
7-3-9. Setting the cue time at execution of AUTO CUE/AUTO-ID.....	107
7-3-10. Setting the format of the playback time code.....	108
7-3-11. Setup of the playback time code frame rate.....	108
7-3-12. Setup of TC output ON/OFF in the PAUSE mode.....	108
7-3-13. Setting the TC output type in the fast winding mode.....	108
7-3-14. Setting the event start mode by REF TC.....	108
7-3-15. Setting the time code to be recorded.....	109
7-3-16. Setting the CHASE operating mode.....	109
7-3-17. Setting the lock window.....	109
7-3-18. Setting the external clock.....	109
7-3-19. All reset of the user memory.....	110
7-3-20. Service menu.....	110

7-1. The SETUP Mode Items

Various setup items are provided in the SETUP mode as listed below and D-15 can be used under the best environment by using these setup items as required.

1. Confirmation of the software version.
2. Selection of the reference level.
3. Setup of the skip play mode.
4. Setup of the pause off time.
5. Setup of ON/OFF for recording S-ID during a recording.
6. Setup ON/OFF of panel lock at remote controlling (Functions only when the optional Model 8336 is installed).
7. Setup of peak hold time for the level meter.
8. Setup of the AUTO CUE/AUTO ID cue level.
9. Setup of the AUTO CUE/AUTO ID cue time.
10. Selecting the playback time code (Functions only when the optional Model 8335 is installed).
11. Setup of the time code playback frame rate (Functions only when the optional Model 8335 is installed).
12. Setup of the time code output at pause (Functions only when the optional Model 8335 is installed).
13. Selecting the time code format during fast winding (Functions only when the optional Model 8335 is installed).
14. Selecting event start by the reference time code (Functions only when the optional Model 8335 is installed).
15. Selecting the time code to be recorded (Functions only when the optional Model 8335 is installed).
16. Selecting the chase operating mode (Functions only when the optional Model 8335 is installed).
17. Selecting the lock window (Functions only when the optional Model 8335 is installed).
18. Selecting the external clock (Functions only when the optional Model 8335 is installed).
19. All reset of the user memory.
20. Service menu (Display only and nothing functions).

7-2. Procedure for Entering the Setup Mode

[0] and [1] of the [numerical keypad] are simultaneously pressed to enter from the normal mode to the setup mode. The display will then change to the setup mode and initial display (schematic below) for version checking of the above SETUP menu will be shown.

The displays are the seven segment type numbers and alphabets and the display area consists of the following three blocks:

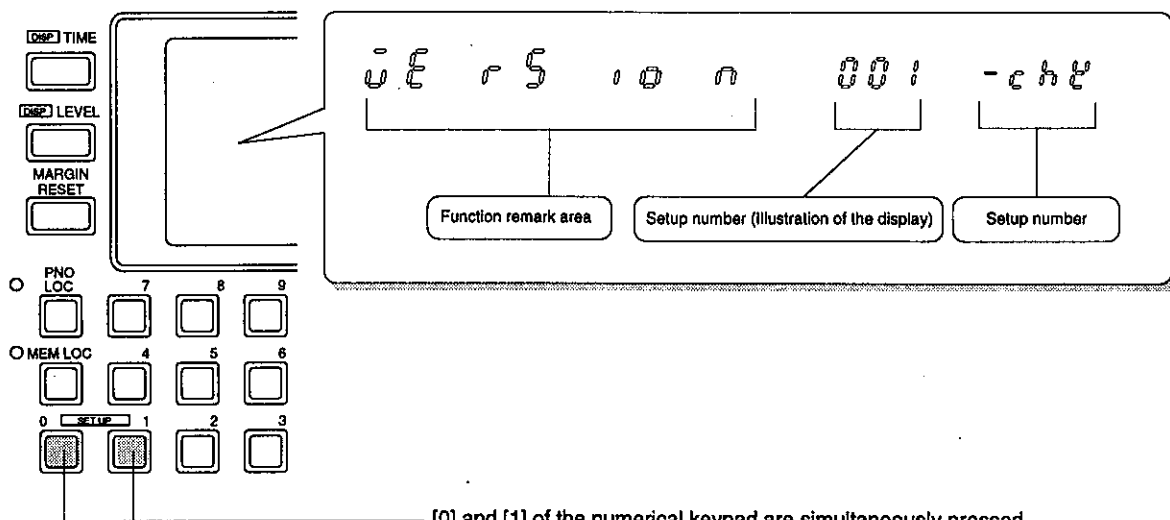

Initial Display of Each SETUP Menu

Initial display of each SETUP menu are as shown below. The [JOG] dial is rotated clockwise or counter clockwise to select the desired SETUP menu. After selecting the initial display, press the [EXECUTE/SET] key to execute the setting.

1. Confirmation of the software version

ŪĒ r S 10 n 001 -c hē

2. Selection of the reference level

rĒ F L ŪL 102 -000

3. Setup of the skip play mode

SĒ ,P ñ o d 103 000

4. Setup of the pause off time

PA US t ñ 104 -000

5. Setup of ON/OFF for recording S-ID during a recording

rĒ Ē , d 106 -000

6. Setup ON/OFF of panel lock at remote controlling

PA nL Lo cē 109 -001

7. Setup of peak hold time for the level meter

PE AY ñ o d 112 -003

8. Setup of the AUTO CUE/AUTO ID cue level

ĒŪ Ē L ŪL 201 -000

9. Setup of the AUTO CUE/AUTO ID cue time

C U E t . n E 202 -000

10. Selecting the playback time code (Display only and nothing functions)

r E P r o t c 401 -002

11. Setup of the time code playback frame rate (Display only and nothing functions)

F r A n E 402 -001

12. Setup of the time code output at pause (Display only and nothing functions)

P A U S t c 403 -000

13. Selecting the time code format at fast winding (Display only and nothing functions)

B . n d t c 404 -000

14. Selecting event start by the reference time code (Display only and nothing functions)

r E F P L Y 405 -000

15. Selecting the time code to be recorded (Display only and nothing functions)

r E C F r A n 411 -000

16. Selecting the chase operating mode (Display only and nothing functions)

C A S E n o d 501 -000

17. Selecting the lock window (Display only and nothing functions)

L o c k B . n d 502 -010

18. Selecting the external clock (Display only and nothing functions)

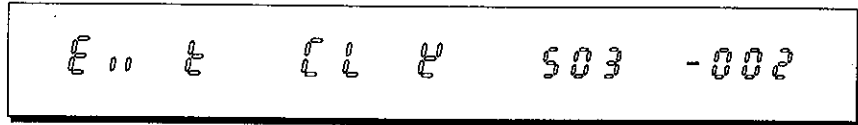

19. All reset of the user memory

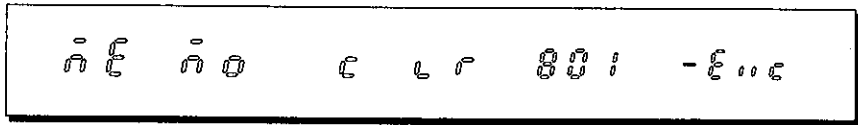

20. Service menu (Display only and nothing functions)



7-3. Executing the SETUP menu

7-3-1. Confirming the ROM version [VE rS ion *** -chk]

ROM version of D-15 can be confirmed here.

The ROM version and date only can be confirmed by this SETUP menu and cannot do any setup.

* If the optional Model 8335 (TC/SYNC card) is installed, not only the D-15 version but the Model 8335 version and date can be confirmed. For details, please refer to the Owners Manual of Model 8335.

Operating procedure

1. After entering the SETUP mode by simultaneously pressing the numerical keypad [0] and [1], manipulate the [JOG] dial to select the initial display of "VE rS ion *** -chk."
2. Next, if the [EXECUTE/SET] key is pressed, the ROM version content is shown in the display as follows for confirmation.

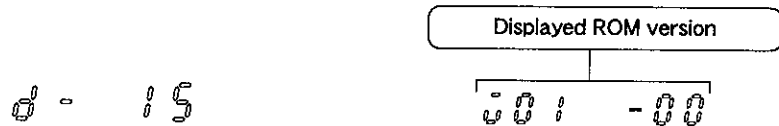

3. Then, date of the ROM is displayed by rotating the [JOG] dial. The version and date on display is alternately shown by rotating the [JOG] dial.

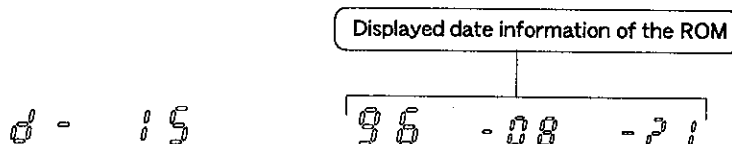

* Press once the [QUIT/RCL] key or the [DISP TIME] key to return to the initial display. Also, to retreat from the SETUP mode, press the [QUIT/RCL] or DISP TIME keys twice in succession.

7-3-2. Setting the reference level [rEF L VL 102 -*]**

In the following, the reference level of the D-15 can be selected.
 The reference level can be selected from three levels of -12dB/-18dB/-20dB.
 This setting will be held although power is switched OFF.

Operating procedure

1. After entering the SETUP mode by simultaneously pressing the numerical keypad [0] and [1], manipulate the [JOG] dial to select the initial display of "rEF L VL 102 -***."
2. Next, if the [EXECUTE/SET] key is pressed, the presently set reference level is shown in the display and, at the same time, the setup number will blink.

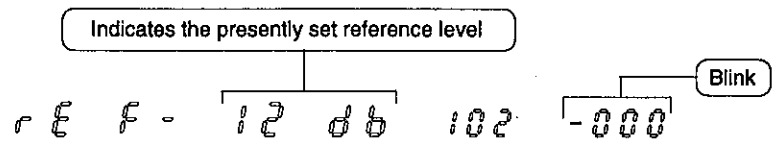

3. Then, as the blinking setup number will alternately change if the [JOG] dial is rotated, let the desired setup number to be shown in the display. Each setup number respectively represents the following reference levels. (*) is initial setting.

** Press once the [QUIT/RCL] key or the [DISP TIME] key to return to the initial display. Also, to retreat from the SETUP mode, press the [QUIT/RCL] or [DISP TIME] keys twice in succession.*

Setup number	Content
"000" (*)	Reference level -12dB (initial setup figure)
"001"	Reference level -18dB
"002"	Reference level -20dB

4. After selecting, press the [EXECUTE/SET] key.
 Setup of the selected reference level will end and the initial display will be shown.

** In order to retreat from the SETUP mode, press the [QUIT/RCL] key or [DISP TIME] key.*

** If the reference level setting is changed, the reference display ([REF **]) in the front panel display section will change to this level setting.*

7-3-3. Setting the skip play mode [SK IP M od 103 -***]

In the following, when the D-15 detects a SKIP-ID recorded on the tape, in what way D-15 will behave in the skip play operation will be setup. This setting will be held although power is switched off. Skip play operation can be selected from among the following three.

Skip off	SKIP-ID will be ignored.
Skip pause	When SKIP-ID is detected during playback, it skips to the next S-ID and PAUSE at that point.
Skip play	When SKIP-ID is detected during playback, it skips to the next S-ID and plays back from that point.

Operating procedure

1. After entering the SETUP mode by simultaneously pressing the numerical keypad [0] and [1], manipulate the JOG dial to select the initial display of "SK IP M od 103 -***."
2. Next, if the [EXECUTE/SET] key is pressed, simultaneous with displaying the presently set skip play mode, the set number will blink.

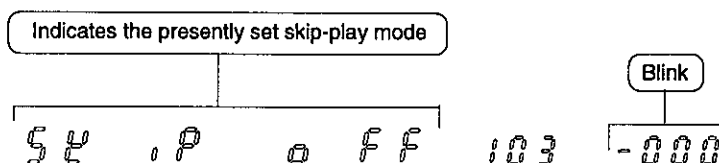

3. Then, as the blinking setup number will change alternately when the [JOG] dial is rotated, let the desired setup number to be displayed. Each setup number respectively represents the following skip play mode. (*) is initial setting.

Setup number	Content
"000" (*)	Skip oFF (SKIP-ID is ignored and not function)
"001"	Skip stP (SKIP -> PAUSE is executed)
"002"	Skip PL y(SKIP -> PLAY is executed)

4. After selecting, press the [EXECUTE/SET] key. Setup of the selected skip play mode will end and the initial display is shown.

* Press the [QUIT/RCL] key or the [DISP TIME] key to retreat from the SETUP mode.

7-3-4. Setting the pause off time [PA US tM 104 -***]

Setup of the pause off time, to automatically release the PAUSE mode and STOP the transport when D-15 is in PAUSE, will be explained here.

This setting will be held even though the power is switched OFF.

Pause off time can be selected and set from six different times of 30 seconds/ 1 minute/2 minutes/3 minutes/4 minutes/5 minutes.

Operating procedure

1. After entering the SETUP mode by simultaneously pressing the numerical keypad [0] and [1], manipulate the [JOG] dial to select the initial display of "PA US tM 104 -***."
2. Next, if the [EXECUTE/SET] key is pressed, simultaneous with displaying the presently set pause off time, the set number will blink.

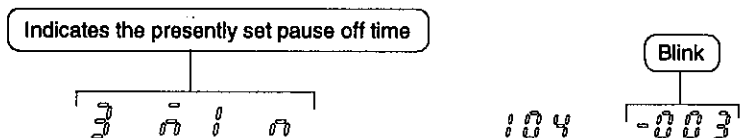

3. Then, as the blinking setup number will change alternately when the [JOG] dial is rotated, let the desired setup number to be displayed.
*Each setup number respectively represents the following pause off time.
 (*) is initial setting.*

Setup number	Content
"000"	Pause off time 30 seconds
"001"	Pause off time 1 minute
"002"	Pause off time 2 minutes
"003" (*)	Pause off time 3 minutes
"004"	Pause off time 4 minutes
"005"	Pause off time 5 minutes

4. After selecting, press the [EXECUTE/SET] key.
Setup of the selected pause off time will be completed and the initial display is shown.

** Press the [QUIT/RCL] key or the [DISP TIME] key to retreat from the SETUP mode.*

7-3-5. Setting the mode for recording S-ID/P NO into the record starting point
[rE C id 106 -*]**

Here, whether S-ID/P NO should be automatically recorded or not only at the point where recording is started (pressing the [PLAY] button while pressing the [RECORD] button or, when recording is entered in the AUTO REC mode at the memory [00] point), is setup.

The S-ID/P NO recording mode at entering the recording mode, can either be switched "ON" or "OFF." This setting will be held even if power is switched OFF.

<NOTE>

Not the sound rise up point but the point where D-15 entered the recording mode is where S-ID/P NO is automatically recorded with this mode switched "ON." However, when recording is started with the AUTO-ID mode switched "ON," it must be noted that S-ID/P NO will not be recorded by the AUTO-ID function even if the sound rise up point arrives within 9 seconds of the S-ID recorded at the record starting point.

Operating procedure

1. After entering the SETUP mode by simultaneously pressing the numerical keypad [0] and [1], manipulate the [JOG] dial to select the initial display of "rE C id 106 -***."
2. Next, if the [EXECUTE/SET] key is pressed, simultaneous with displaying the presently set ON/OFF of the record mode, the set number will blink.

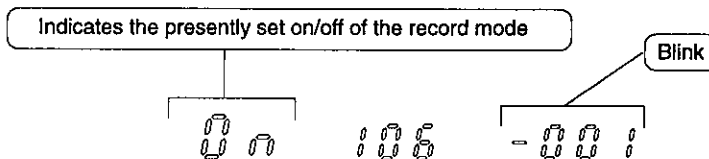

3. Then, as the blinking setup number will change alternately when the [JOG] dial is rotated, let the desired setup number to be displayed.
Each setup number respectively represents the following modes. () is initial setting.*

Setup number	Content
"000"	Record mode off (OFF) S-ID/P NO is not recorded at the record starting point.
"001" (*)	Record mode on (ON) S-ID/P NO is recorded at the record starting point.

4. After selecting, press the [EXECUTE/SET] key.
Setup of the record mode will be completed and the initial display is shown.

* Press the [QUIT/RCL] key or the [DISP TIME] key to retreat from the SETUP mode.

7-3-6. Setup of panel lock ON/OFF [PA nL Lo cK 109 -*]**

ON/OFF of the D-15 panel lock is setup by this menu.

This function is used mainly for ON/OFF of panel locking by installing Model 8336 (RS-422 interface card: to be sold soon) in D-15 and using it in the 9P-REMOTE mode. In other words, when D-15 is to be controlled by external equipment through the SONY 9 pin PROTOCOL, whether D-15 is to be controlled only from external equipment, or in addition to control by external equipment, to allow controlling also from the D-15 front panel, can be setup. For actual method is using this, refer to the Model 8336 Owner's Manual.

This function is also effective when the optional Model 8336 is not installed. In other words, when this mode is switched "ON," it will lock the panel when the D-15 front panel [REMOTE] selector is switched from [LOCAL] to [9P REMOTE] and keys other than [DISP TIME]/[DISP LEVEL]/[MARGIN RESET] will be inactive.

Operating procedure

1. After entering the SETUP mode by simultaneously pressing the numerical keypad [0] and [1], manipulate the [JOG] dial to select the initial display of "PA nL Lo cK 109 -***".
2. Next, if the [EXECUTE/SET] key is pressed, simultaneous with displaying the presently set ON/OFF of the panel lock mode, the set number will blink.

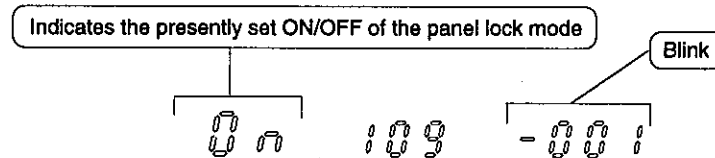

3. Then, as the blinking setup number will change alternately when the [JOG] dial is rotated, let the desired setup number to be displayed. Each setup number respectively represents the following modes. (*) is initial setting.

Setup number	Content
"000"	Panel lock OFF In addition to control from external equipments, control is also possible from the front panel.
"001" (*)	Panel lock ON (Initial setting) Can be controlled only from external equipments. However, the [OPEN/CLOSE] button, [DISPTIME] / [DISP LEVEL] and [MARGIN RESET] keys only is functional from the front panel.

4. After selecting, press the [EXECUTE/SET] key. Setup of the panel lock mode will be completed and the initial display is shown.

* Press the [QUIT/RCL] key or the [DISP TIME] key to retreat from the SETUP mode.

7-3-7. Setting the peak hold time [PE AK H od 112-***]

Peak hold time of the D-15 level meter function is setup.

Hold time can be set over 0 ~ 5 seconds in one second increments and also in permanent peak hold.

This setting will be held even though power is switched off.

Operating procedure

1. After entering the SETUP mode by simultaneously pressing the numerical keypad [0] and [1], manipulate the [JOG] dial to select the initial display of "PE AK H od 112-***."
2. Next, if the [EXECUTE/SET] key is pressed, simultaneous with displaying the presently set peak hold time, the set number will blink.

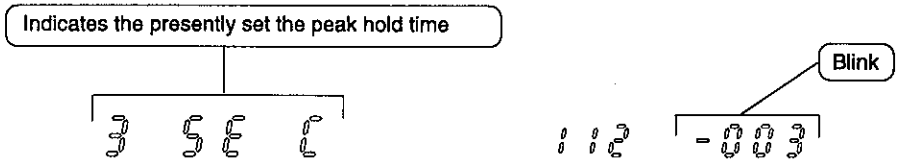

3. Then, as the blinking setup number will change alternately when the [JOG] dial is rotated, let the desired setup number to be displayed.
Each setup number respectively represents the following peak hold time.
(* is initial setting.)

Setup number	Content
"000"	Peak hold time 0 second
"001"	Pause off time 1 second
"002"	Pause off time 2 seconds
"003" (*)	Pause off time 3 seconds
"004"	Pause off time 4 seconds
"005"	Pause off time 5 seconds
"006"	Permanent peak hold (Can be reset by the [MARGIN RESET] key)

4. After selecting, press the [EXECUTE/SET] key.
Setup of the selected peak hold time will be completed and the initial display is shown.

* Press the [QUIT/RCL] key or the [DISP TIME] key to retreat from the SETUP mode.

7-3-8. Setting the cue level for execution of AUTO CUE/AUTO-ID [CU EL VL 201 -*]**

Here, cue level to determine the sound rise up point necessary when D-15 executes the AUTO CUE mode and records the S-ID/P NO in the AUTO-ID mode will be setup. Cue level can be set from four types (-55dB, -40dB, -30dB, -20dB). This level will be held even though the power is switched OFF.

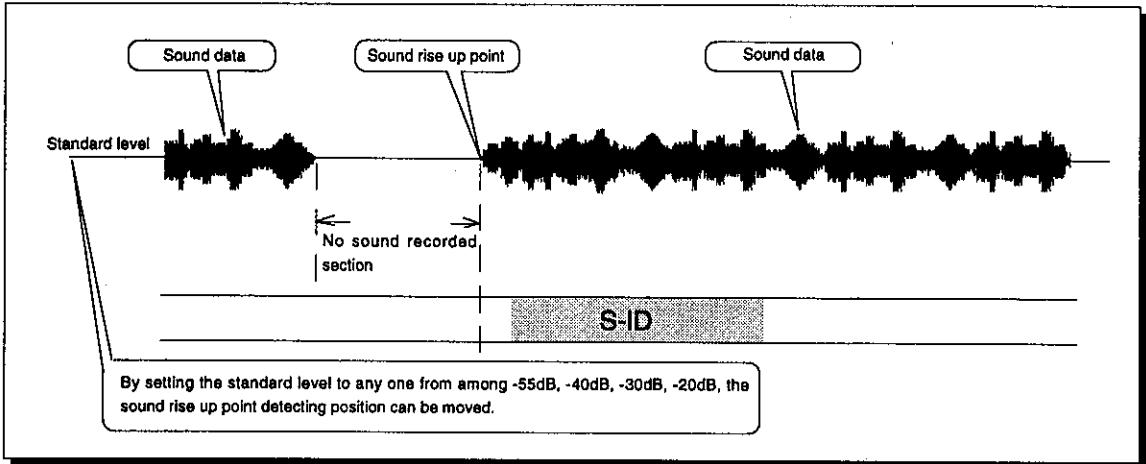

Operating procedure

1. After entering the SETUP mode by simultaneously pressing the numerical keypad [0] and [1], manipulate the [JOG] dial to select the initial display of "CU EL VL 201 -***."
2. Next, if the [EXECUTE/SET] key is pressed, simultaneous with displaying the presently set AUTO CUE/AUTO ID cue level, the set number will blink.

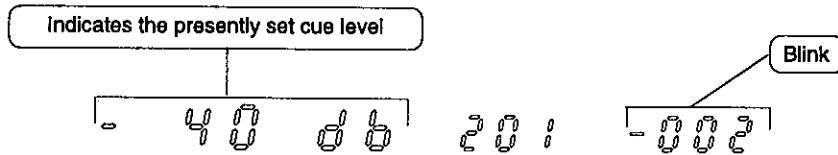

3. Then, as the blinking setup number changes alternately when the [JOG] dial is rotated, select the desired setup number to be displayed. Each setup number respectively represents the following cue level. (*) is initial setting.

Setup number	Content
"000"	Cue level -20dB
"001"	Cue level -30dB
"002" (*)	Cue level -40dB
"003"	Cue level -55dB

4. After selecting, press the [EXECUTE/SET] key. Setup of the selected cue level will be completed and the initial display is shown.

* Press the [QUIT/RCL] key or the [DISP TIME] key to retreat from the SETUP mode.

7-3-9. Setting the cue time at execution of AUTO CUE/AUTO-ID [CU E ti ME 202 -***]

Here, cue level to determine the sound rise up point necessary when D-15 executes the AUTO CUE mode and records the S-ID/P NO in the AUTO-ID mode will be setup. Cue time figures can be selected from five types (300msec/600msec/900msec/1.2sec/1.5sec).

This setting will be held even though the power is switched OFF.

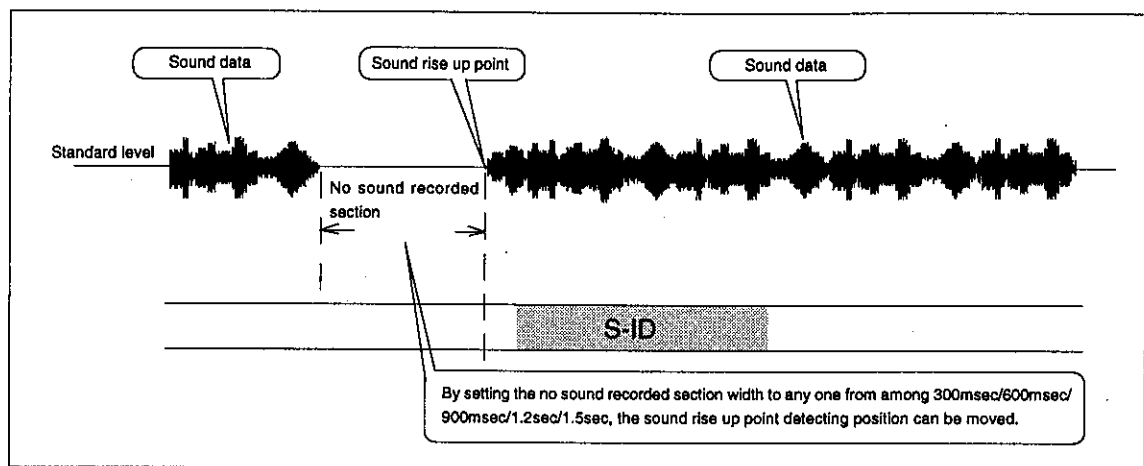

Operating procedure

1. After entering the SETUP mode by simultaneously pressing the numerical keypad [0] and [1], manipulate the [JOG] dial to select the initial display of "CU E ti ME 202 -***."
2. Next, if the [EXECUTE/SET] key is pressed, simultaneous with displaying the presently set AUTO CUE/AUTO ID cue time, the set number will blink.

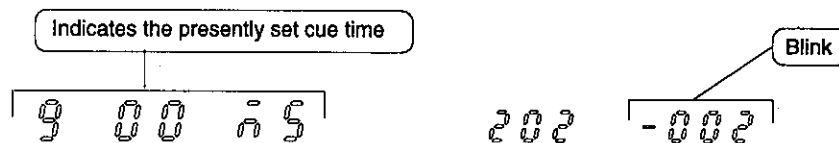

3. Then, as the blinking setup number will change alternately when the [JOG] dial is rotated, let the desired setup number to be displayed.
Each setup number respectively represents the following cue time. (*) is initial setting.

Setup number	Content
"000"	Cue time 300msec.
"001"	Cue time 600msec.
"002" (*)	Cue time 900msec.
"003"	Cue time 1.2msec.
"004"	Cue time 1.5msec.

4. After selecting, press the [EXECUTE/SET] key.
Setup of the selected cue level will be completed and the initial display is shown.

* Press the [QUIT/RCL] key or the [DISP TIME] key to retreat from the SETUP mode.

7-3-10. Setting the format of the playback time code [rE Pr o tc 401 -*]**

The format for playback of the time code is set by this menu and will function when the optional Model 8335 (TC/SYNC card) is installed in D-15.

If Model 8335 is not installed, changing the menu setting will have no affect in operation of D-15.

** Read the Model 8335 Owners Manual for actual method in operating it.*

7-3-11. Setup of the playback time code frame rate [Fr AM E 402 -*]**

The frame rate for playback of the time code is set by this menu and will function when the optional Model 8335 (TC/SYNC card) is installed in D-15.

If Model 8335 is not installed, changing the menu setting will have no affect in operation of D-15.

** Read the Model 8335 Owners Manual for actual method in operating it.*

7-3-12. Setup of TC output ON/OFF in the PAUSE mode [PA US tc 403 -*]**

Whether time code should be output or not in the PAUSE mode is set by this menu and functions when the optional Model 8335 (TC/SYNC card) is installed in D-15.

If Model 8335 is not installed, changing the menu setting will have no affect in operation of D-15.

** Read the Model 8335 Owners Manual for actual method in operating it.*

7-3-13. Setting the TC output type in the fast winding mode [Wi nd tc 404 -*]**

The time code output type in the FAST FORWARD or REWIND mode is set by this menu and will function when the optional Model 8335 (TC/SYNC card) is installed in D-15.

If Model 8335 is not installed, changing the menu setting will have no affect in operation of D-15.

** Read the Model 8335 Owners Manual for actual method in operating it.*

7-3-14. Setting the event start mode by REF TC [rE F PL Y 405 -*]**

Event start operating mode by the reference time code is setup by this menu and functions when the optional Model 8335 (TC/SYNC card) is installed in D-15.

If Model 8335 is not installed, changing the menu setting will have no affect in operation of D-15.

** Read the Model 8335 Owners Manual for actual method in operating it.*

7-3-15. Setting the time code to be recorded [rE C Fr AM 411 -*]**

The frame rate (29.97 fps or 30 fps only) when recording external time code is set by this menu and will function when the optional Model 8335 (TC/SYNC card) is installed in D-15.

If Model 8335 is not installed, changing the menu setting will have no affect in operation of D-15.

** Read the Model 8335 Owners Manual for actual method in operating it.*

7-3-16. Setting the CHASE operating mode [CH SE M od 501 -*]**

The operating mode of time code chase against the external time code is setup by this menu and will function when the optional Model 8335 (TC/SYNC card) is installed in D-15.

If Model 8335 is not installed, changing the menu setting will have no affect in operation of D-15.

** Read the Model 8335 Owners Manual for actual method in operating it.*

7-3-17. Setting the lock window [Lo ck Wi nd 502 -*]**

The frame width for determining the unlock state after CHASE lock in the CHASE operation with external equipments is setup by this menu and functions when the optional Model 8335 (TC/SYNC card) is installed in D-15.

If Model 8335 is not installed, changing the menu setting will have no affect in operation of D-15.

** Read the Model 8335 Owners Manual for actual method in operating it.*

7-3-18. Setting the external clock [Ex t CL K 503 -*]**

The D-15 external sync signal type is setup by this menu and functions when the optional Model 8335 (TC/SYNC card) is installed in D-15.

If Model 8335 is not installed, changing the menu setting will have no affect in operation of D-15.

** Read the Model 8335 Owners Manual for actual method in operating it.*

7-3-19. All reset of the user memory [ME Mo c Lr 801 -Exc]

Data in the TIME and SETUP memories can all be reset.

Operating procedure

1. After entering the SETUP mode by simultaneously pressing the numerical keypad [0] and [1], manipulate the [JOG] dial to select the initial display of "ME Mo c Lr 801 -Exc."
2. Next, if the [EXECUTE/SET] key is pressed, the display setup number section [Exc] will blink.

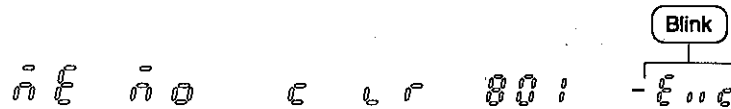

3. Then, while in the blinking state, press the [EXECUTE/SET] key again.
This resets all data in the user memory, blinking will cease and the initial display will be shown.

** Press the [QUIT/RCL] key or the [DISP TIME] key to retreat from the SETUP mode.*

7-3-20. Service menu [SE rV ic E 900 -***]

This menu is for service checking and although this can be displayed, it will not function even if the EXECUTE/SET key is pressed.

Chapter 8. Various Applications

Various D-15 application method are explained based on actual interconnecting schematics.

Chapter 8. Table of Contents

8-1. Simple Editing by Connecting Two D-15s.....	112
8-2. External Sync Driving Using Digital In.....	114
8-3. Digital Copy Using Optical Digital In.....	115
8-4. Connection of Event Outputs (GPI) from an Editor.....	116

8-1. Simple Editing by Connecting Two D-15s

Simultaneously with the start of recording from the memory [00] point of the recorder in the auto record mode, EVENT 0 (GPI) is output and the player will instant start.

Editing of sound in DAT frame units is thus possible. Also, editing of sound with higher accuracy is possible if the start of a tune is located accurately beforehand such as with the RAM scrub function.

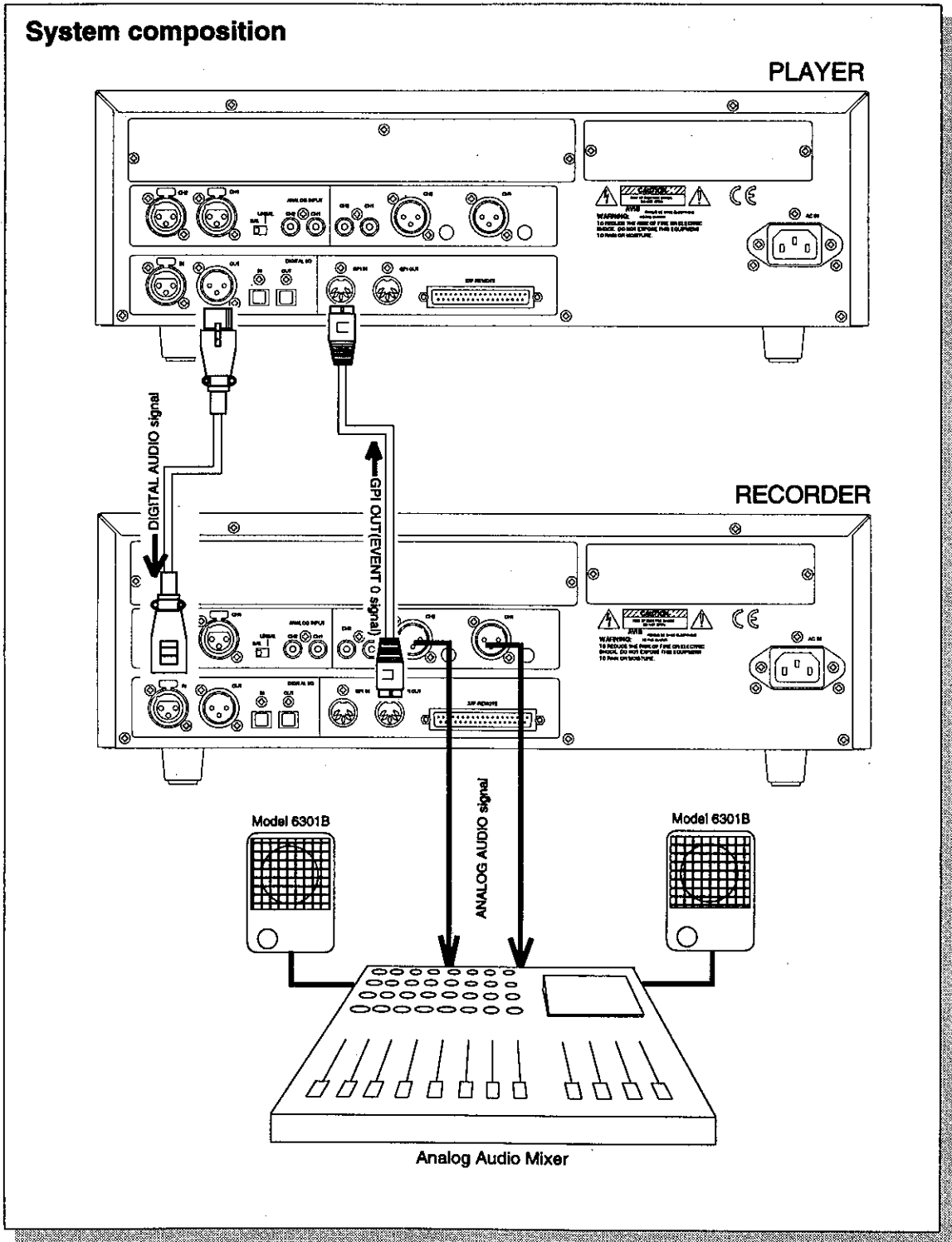

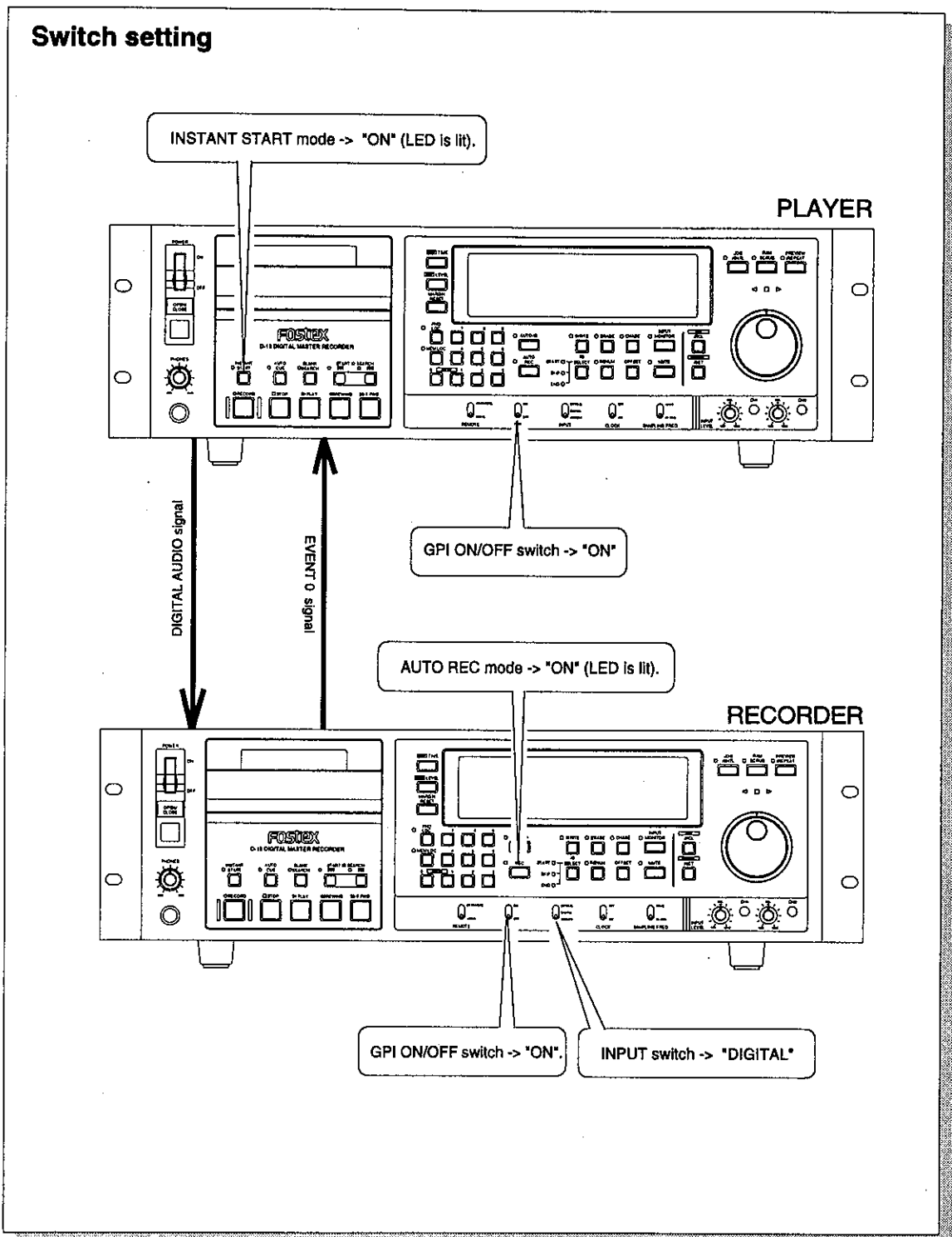

8-2. External Sync Driving Using Digital In

By input of digital out from other digital equipment to the D-15, it can be driven by an external sync signal (example: External sync driving is possible even at 44.056kHz).

<NOTE>

For reproduction of 44.056kHz, the 44.1kHz channel status must be set on the tape.

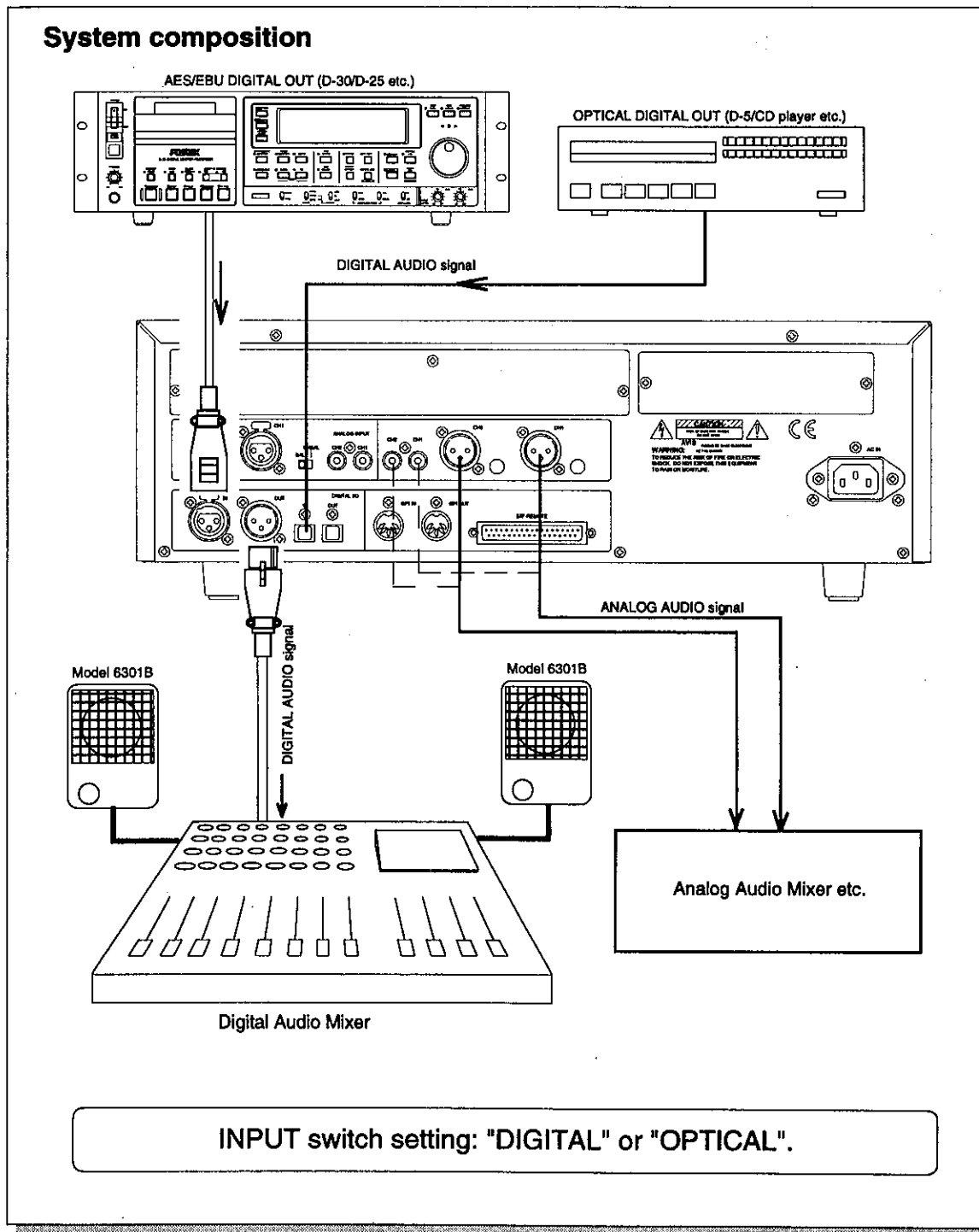

8-3. Digital Copy Using Optical Digital In

When optical digital input is used, digital copy including the S-ID between DATs can be done.

<NOTE>

FS and emphasis will be automatically set by the digital signal information.

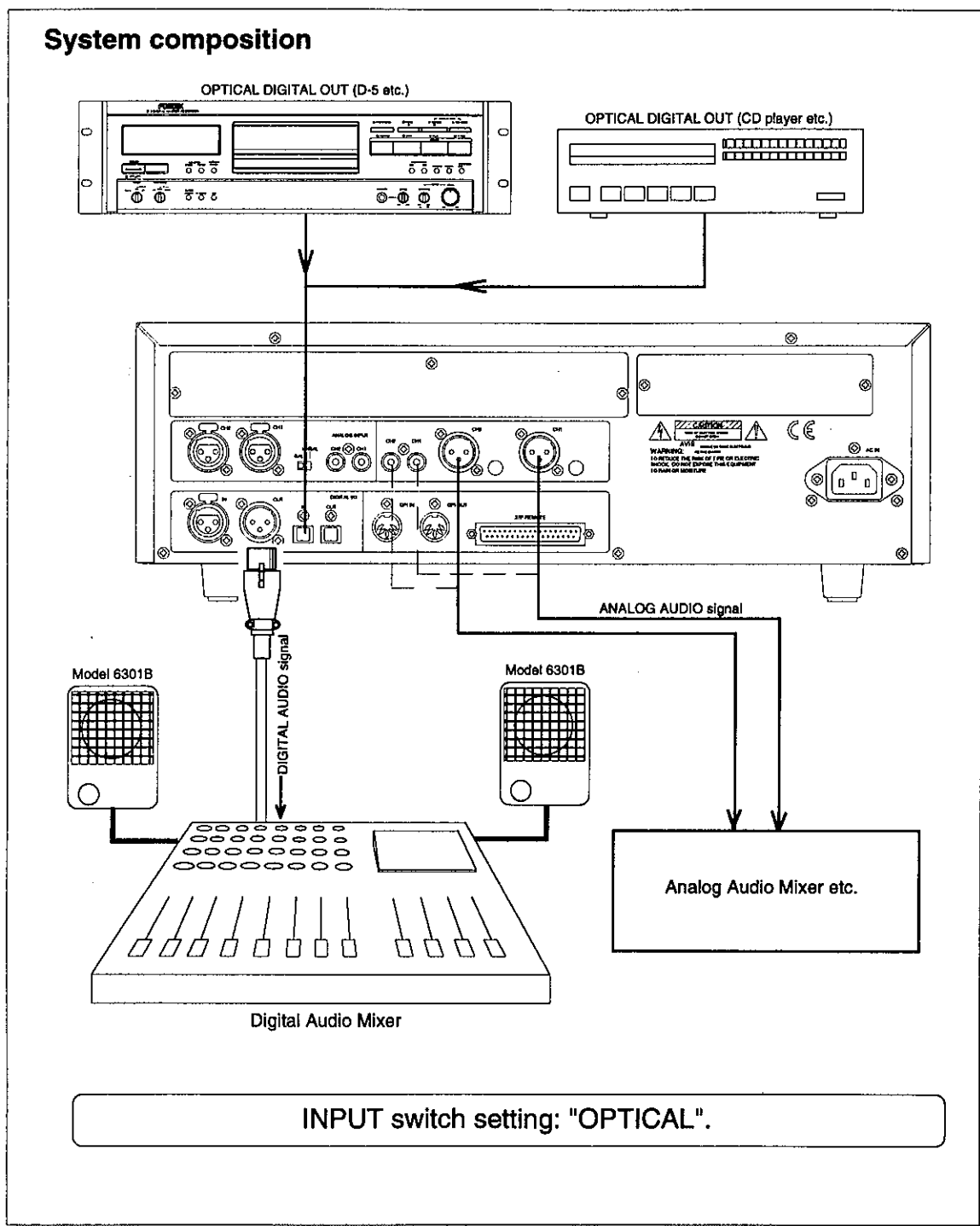

8-4. Connection of Event Outputs (GPI) from an Editor

In the following, sound editing into a VTR by editor control using the event outputs from an editor will be explained.

- * More efficient editing can be done by utilizing functions such as Instant Start and Auto Cue.
- * This GPI connector can also be used for fader starting.

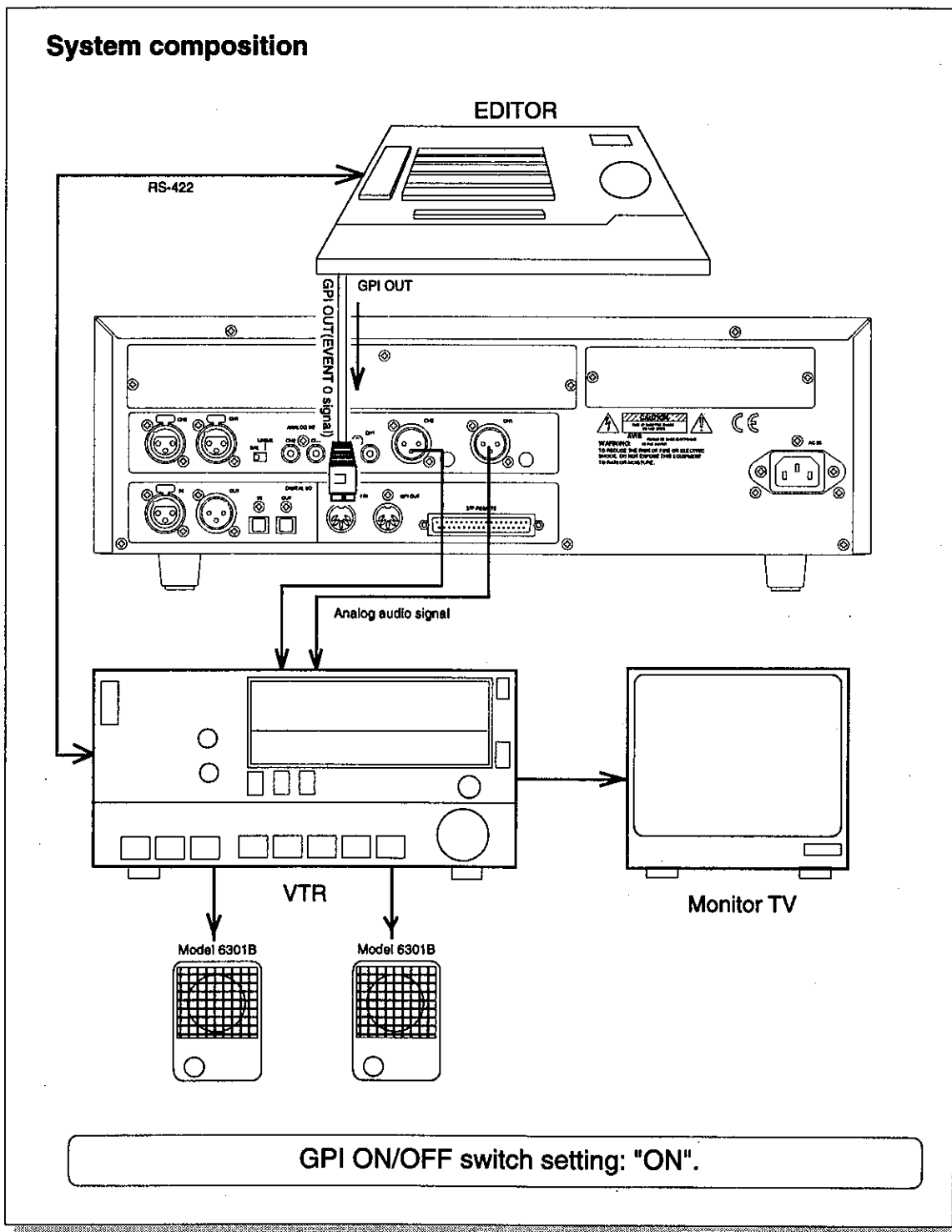

Chapter 9 Specifications

Input/Output Connectors (Pin 2=HOT, analog in/out standard level : 0dBu = 0.775Vrms, 0dBV = 1Vrms)

Analog Audio Inputs

<XLR type>

Connector : XLR-3-31 type (× 2)
 Reference Input Level : +4dBu
 Input Impedance : 20k Ω or more

<RCA pin>

Connector : RCA pin jack (× 2)
 Reference Input Level : -10dBV
 Input Impedance : 10k Ω or more

Analog Audio Outputs

<XLR type>

Connector : XLR-3-32 type (× 2)
 Reference Output Level : +4dBu
 Output Load Impedance : 600 Ω or more

<RCA pin>

Connector : RCA pin jack (× 2)
 Reference Output Level : -10dBV
 Output Load Impedance : 10k Ω or more

Digital Audio Inputs

<AES/EBU>

Connector : XLR-3-31 type (× 1)
 Format : IEC958 part 3 (AES/EBU)

<S/P DIF>

Connector : Optical (× 1)
 Format : IEC958 part 2 (S/P DIF)

Digital Audio Outputs

<AES/EBU>

Connector : XLR-3-32 type (× 1)
 Format : IEC958 part 3 (AES/EBU)

<S/P DIF>

Connector : Optical (× 1)
 Format : IEC958 part 2 (S/P DIF) : Cannot output at RAM playback.

Headphone Output

Connector : ϕ 6mm stereo phone jack (× 1)
 Output Load Impedance : 8 Ω or more
 Max. Output Level : 100mW (at 32 Ω)

GPI Input

Connector : DIN 5 pin (× 1)
 PNP transistor input, Low active (4.7k Ω /+5V, Pull up)

D-15 Owner's Manual (Chapter 9 Specifications)

GPI Output

Connector : DIN 5 pin (× 1)
Open collector, VCEO : 25V, I_{cmax} : 25mA

37 pin Remote

Connector : D-SUB 37 pin (× 1)
Input Command : Parallel Input
PNP transistor input, Low active (4.7k Ω /+5V, pull up)
Output Status : Parallel Output
Open collector (4.7k Ω /+5V, pull up)

General

Recording Format : IEC DAT standard, Part 1
: IEC DAT standard, Part 5 (installed Model 8335)
Recording Tape : Digital Audio Tape
Number of Channel : Audio × 2
Recording Time : 120 minutes (T-120 tape)
Error Correction : Double Reed Solomon Code
Sampling Frequency : 48kHz, 44.1kHz
Quantization : 16 bit linear
A/D : 18bit 64 times, Over sampling, Delta-Sigma modulation
D/A : 20bit 128 times, Over sampling, Delta-Sigma modulation
Di-emphasis : 50 μ sec/15 μ sec, Playback only (automatic)
Copy Guard : Not provided
Head Composition : Rotating 2 head
Sylinder size : φ 30mm
Motor Construction : 4 motors (DD × 2)
Loading System : Tray type
Fast Wind Time : Approx. 60 seconds (T-120 tape)
Fast Wind Speed : Max. 180 times
Search Speed : 1/2, 1, 2, 3, 5, 9, 16 times
RAM : 8M bit, Max. 5 sec. (at 48kHz)
RAM search Speed : 0 ~ 1 times
R/P Frequency Response : 20Hz ~ 20kHz
S/N Ratio : 92dB
Dynamic Range : 92dB
Total Harmonic Distortion : 0.05% (1kHz, +4dBu)
Channel Separation : 80dB (1kHz)
Wow and Flutter : Lower than measurable limit
Standard Recording Level : -20dB/-18dB/-12dB (Change of SETUP mode, Default
Setting : -12dB) (0dB = 16 bit full scale level)
Power Supply : 120VAC 60Hz (AC inlet type)
: 230V ~ 50/60Hz (AC inlet type)
: 230V ~ 50Hz (AC inlet type)
Power Consumption : 39W
Physical dimentions : 482 (W) × 150 (H) × 371 (D) mm
Weight : Approx. 9.0kg

* Specifications and physical appearance of this equipment is subject to change or improvement without advance notice.

Declaration of EC Directive

This equipment is compatible with the EMC Directive (89/336/EEC) - Directive on approximation of member nation's ordinance concerning the electromagnetic compatibility and with the Low Voltage Directive (73/23/EEC) - Directive on approximation of member nation's ordinance concerning electric equipment designed to be used within the specified voltage range.

The Affect of Immunity on This Equipment

The affect of the European specification EN50082-1 (coexistence of electromagnetic waves - common immunity specification) on this equipment are as shown below.

** In the electrical fast transient/burst requirements, radiated electromagnetic field requirements and static electricity discharging environment, this could be affected by generation of noise and deterioration of error rate in some vases. The display content could also differ from actual figures.*

Please comply to the precautions below to make this equipment compatible with European Specification EN50082-1 (coexistence of electro - magnetic waves - common immunity specification).

<NOTE>

Caps are fitted on the rear panel GPI (IN/OUT), ANALOG (IN/OUT) and 37P-REMOTE connectors, the ANALOG OUT level trimmer holes and the front panel INPUT level trimmer holes. These caps are fitted to prevent affect of static electricity on this equipment. Do not remove these caps other than when making access to these connectors and trimmers.

FOSTEX DISTRIBUTORS LIST IN EUROPE

* Including non-EU countries.

* underlined: contracted distributors (as of November, 1997)

<AUSTRIA>

NAME: ATEC Audio-u. Videogeraete VertriebsgesmbH.
ADD: Im Winkel 5, A-2325 Veim, Austria
TEL: (+43) 2234-74004, FAX: (+43) 2234-74074

<BELGIUM>

NAME: EML N. V.
ADD: Bijvennestraat 1A, B3500 Hasselt, Belgium
TEL: (+32) 11-232355, FAX: (+32) 11-232172

<DENMARK>

NAME: SC Sound ApS
ADD: Malervej 2, DK-2630 Taastrup, Denmark
TEL: (+45) 4399-8877, FAX: (+45) 4399-8077

<FINLAND>

NAME: Noretron Audio
ADD: Tonttumuorinkuja 4, FIN-02200 Espoo, Finland
TEL: (+358) 0-5259330, FAX: (+358) 0-52593352

<FRANCE>

NAME: Musikengro
ADD: ZAC de Follieuses, B. P. 609, 01706 Les Echets,
France
TEL: (+33) 72 26 27 00, FAX: (+33) 72 26 27 01

<GERMANY>

NAME: Studiosound & Music GmbH
ADD: Scheppe Gewissegasse 8, D-35039 Marburg,
Germany
TEL: (+49) 6421-12071, FAX: (+49) 6421-15522

<GREECE>

NAME: Bon Studio S. A.
ADD: 6 Zaimi Street, Exarchia, 106.83 Athens, Greece
TEL: (+30) 1-3809605-8, 3302059
FAX: (+30) 1-3845755

<ICELAND>

NAME: I. D. eirf. electronic Ltd.
ADD: Armula 38 108 Reykjavik, Iceland
TEL: (+354) 588 5010, FAX: (+354) 588 5011

<ITALY>

NAME: Recoton Italia Srl.
ADD: V. 1 Maggio, N 18, 40050 Quarto Inferiore, (BO)
Italy
TEL: (+39) 51-768576, FAX: (+39) 51-768336

<THE NETHERLANDS>

NAME: IEMKE ROOS AUDIO B. V.
ADD: Kuiperweg 20, 1101 AG Amsterdam, The
Netherlands
TEL: (+31) 20-697-2121, FAX: (+31) 20-697-4201

<NORWAY>

NAME: Siv. Ing. Benum A/S
ADD: P. O. Box 145 Vinderen, 0319 Oslo 3, Norway
TEL: (+47) 22-139900, FAX: (+47) 22-148259

<PORTUGAL>

NAME: Caius - Tecnologias Audio e Musica. Lda.
ADD: Rua de Santa Catarina, 131 4000 Porto, Portugal
TEL: (+351) 2-2084456/325400
FAX: (+351) 2-314760

<SPAIN>

NAME: Multitracker. S. A.
ADD: C/Garcilaso No.9, Madrid 28010, Spain
TEL: (+34) 1-4470700, 1-4470898
FAX: (+34) 1-5930716

<SWEDEN>

NAME: TTS Tal & Ton Studioteknik AB
ADD: Gelbgjutarevagen 4, S-171 48 Solna, Sweden
TEL: (+46) 8-7340750, FAX: (+46) 8-824476

<SWITZERLAND>

NAME: Audio Bauer Pro AG
ADD: Bernerstrasse-Nord 182, CH-8064 Zurich,
Switzerland
TEL: (+41) 1-4323230, FAX: (+41) 1-4326558

<UK>

NAME: SCV London
ADD: 3A 6-24 Southgate Road, London N1 3JJ,
England, UK
TEL: (+44) 171-923-1892, FAX: (+44) 171-241-3644

MEMO

A series of horizontal dashed lines for writing a memo.

FOStex

FOSTEX CORPORATION

3-2-35 Musashino, Akishima-shi, Tokyo 196, Japan

FOSTEX CORPORATION OF AMERICA

15431, Blackburn Ave., Norwalk, CA 90650, U. S. A.