

Owner's Manual

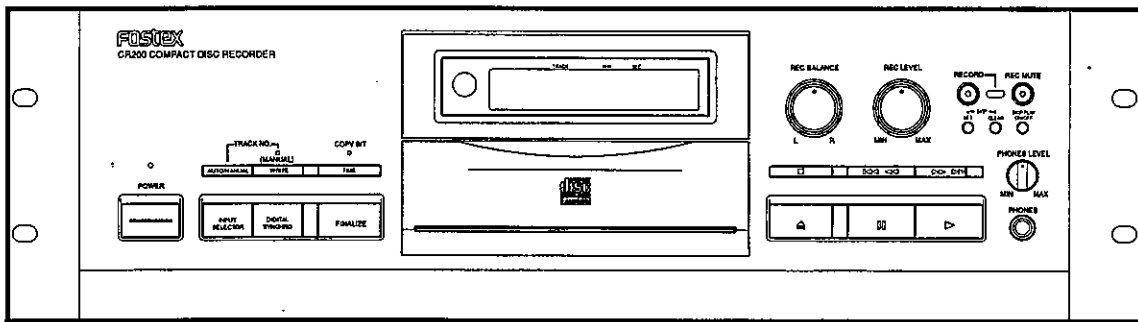

Model CR200

COMPACT DISC RECORDER

COMPACT
disc
DIGITAL AUDIO
Recordable



Fostex

	CAUTION RISK OF ELECTRIC SHOCK DO NOT OPEN	
<p>CAUTION: TO REDUCE THE RISK OF ELECTRIC SHOCK, DO NOT REMOVE COVER (OR BACK). NO USER-SERVICEABLE PARTS INSIDE. REFER SERVICING TO QUALIFIED SERVICE PERSONNEL.</p>		



The lightning flash with arrowhead symbol, within an equilateral triangle, is intended to alert the user to the presence of uninsulated "dangerous voltage" within the product's enclosure that may be of sufficient magnitude to constitute a risk of electric shock to persons.



The exclamation point within an equilateral triangle is intended to alert the user to the presence of important operating and maintenance (servicing) instructions in the literature accompanying the appliance.

"WARNING"

"TO REDUCE THE RISK OF FIRE OR ELECTRIC SHOCK, DO NOT EXPOSE THIS APPLIANCE TO RAIN OR MOISTURE."

SAFETY INSTRUCTIONS

1. Read Instructions - All the safety and operating instructions should be read before the appliance is operated.
2. Retain Instructions - The safety and operating instructions should be retained for future reference.
3. Heed Warnings - All warnings on the appliance and in the operating instructions should be adhered to.
4. Follow Instructions - All operating and use instructions should be followed.
5. Water and Moisture - The appliance should not be used near water - for example, near a bathtub, washbowl, kitchen sink, laundry tub, in a wet basement, or near a swimming pool, and the like.
6. Carts and Stands - The appliance should be used only with a cart or stand that is recommended by the manufacturer.



An appliance and cart combination should be moved with care. Quick stops, excessive force, and uneven surfaces may cause the appliance and cart combination to overturn.

7. Wall or Ceiling Mounting - The appliance should be mounted to a wall or ceiling only as recommended by the manufacturer.
8. Ventilation - The appliance should be situated so that its location or position does not interfere with its proper ventilation. For example, the appliance should not be situated on a bed, sofa, rug, or similar surface that may block the ventilation openings; or, placed in a built-in installation, such as a bookcase or cabinet that may impede the flow of air through the ventilation openings.

9. Heat - The appliance should be situated away from heat sources such as radiators, heat registers, stoves, or other appliances (including amplifiers) that produce heat.
10. Power Sources - The appliance should be connected to a power supply only of the type described in the operating instructions or as marked on the appliance.
11. Grounding or Polarization - The precautions that should be taken so that the grounding or polarization means of an appliance is not defeated.
Alternate Warnings - This product is equipped with a three-wire grounding-type plug, a plug having a third (grounding) pin. This plug will only fit into a grounding-type power outlet. This is safety feature. Do not defeat the safety purpose of the grounding-type plug.
12. Power Cord Protection - Power supply cords should be routed so that they are not likely to be walked on or pinched by items placed upon or against them, paying particular attention to cords at plugs, convenience receptacles, and the point where they exit from the appliance.
13. Cleaning - The appliance should be cleaned only as recommended by the manufacturer.
14. Nonuse Periods - The power cord of the appliance should be unplugged from the outlet when left unused for a long period of time.
15. Object and Liquid Entry - Care should be taken so that objects do not fall and liquids are not spilled into the enclosure through openings.
16. Damage Requiring Service - The appliance should be serviced by qualified service personnel when:
 - A. The power supply cord or the plug has been damaged; or
 - B. Objects have fallen, or liquid has been spilled into the appliance; or
 - C. The appliance has been exposed to rain; or
 - D. The appliance does not appear to operate normally or exhibits a marked change in performance; or
 - E. The appliance has been dropped, or the enclosure damaged.
17. Servicing - The user should not attempt to service the appliance beyond that described in the operating instructions. All other servicing should be referred to qualified service personnel.

CONTENTS

CAUTIONS REGARDING HANDLING.....	5
FEATURES.....	6
CHECKING ACCESSORIES.....	7
DISCS.....	8
CONNECTION WITH PROFESSIONAL EQUIPMENT.....	10
CONNECTION WITH OTHER EQUIPMENT	
(1) DIGITAL CONNECTION.....	11
(2) ANALOG CONNECTION.....	12
NAMES AND FUNCTIONS (FRONT PANEL).....	13
NAMES AND FUNCTIONS (REMOTE CONTROL UNIT).....	14
DISPLAY PANEL.....	15
DISC LOADING/UNLOADING.....	16
<hr/>	
MODES OF RECORDING.....	17
RECORDING (1)	
Automatic digital-source synchro recording	
(1-track recording).....	18
Automatic digital-source synchro recording	
(all-track recording).....	19
Automatic digital-source synchro recording	
(recording of the track number in accordance to the DAT	
start ID).....	20
RECORDING (2)	
Analog-source recording.....	21
Recording level adjustment.....	22
RECORDING (3)	
Manual digital-source recording.....	23
MAKING A RECORDED DISC PLAYABLE ON A CD	
PLAYER (FINALIZATION).....	24
What is finalization?.....	24
Finalization procedure.....	24
<hr/>	
PLAYBACK.....	25
Starting playback.....	25
Playing from the desired track (Direct track selection).....	25
Searching an adjacent track (Track search).....	26
Searching the desired point (Manual search).....	26
<hr/>	
CONVENIENT FUNCTIONS FOR RECORDING (1)	
Recording from the middle of a disc.....	27
Checking the remaining recording time.....	27
Checking the recording condition and recording end point	
before recording from the middle of a disc.....	27
CONVENIENT FUNCTIONS FOR RECORDING (2)	
Creating a non-recorded blank.....	28
Starting recording with fade-in.....	28
Ending recording with fade-out.....	28
Ending disc recording with fade-out.....	28
CONVENIENT FUNCTIONS FOR RECORDING (3)	
Manual writing of track number.....	29
Automatic writing of track number.....	29
<hr/>	
SKIPPING UNDESIRE TRACKS	
Recording of skip ID setting data.....	30
Recording of skip ID clear data.....	31
PLAYBACK	
Playing tracks repeatedly (Repeat playback).....	32
Checking the playing time of each track	
(1-track time display).....	32
Fade-in/fade-out during playback.....	32
SKIPPING UNDESIRE TRACKS (SKIP PLAYBACK)	
Skip playback procedure.....	33
PLAYING TRACKS IN THE DESIRED ORDER	
(PROGRAMMED PLAYBACK)	
Programming tracks.....	34
Program reservation.....	34
Clearing the entire program.....	35
Clearing a track from the program.....	35
Checking the programmed tracks.....	35
Replacing a track in the program.....	35
<hr/>	
CHARACTER MESSAGE LIST.....	36
INDEX.....	37
TROUBLESHOOTING.....	38
SPECIFICATIONS.....	39

INTRODUCTION

Thank you for buying the Fostex CR200. Please read the operating instructions so you will know how to operate your new CR200 properly. After reading, please keep them in a safe place for future reference.

In some countries or regions, the shape of the power plug and power outlet may differ from that shown in the drawings. However, the method of connecting and operating the CR200 is the same.

WARNING: TO PREVENT FIRE OR SHOCK HAZARD, DO NOT EXPOSE THIS APPLIANCE TO RAIN OR MOISTURE.

IMPORTANT NOTICE

The serial number for this equipment is located on the rear panel. Please write this serial number on your enclosed warranty card and keep it in a secure area in case of an accident or theft.

This equipment has been tested and found to comply with the limits for a Class B digital device, pursuant to Part 15 of the FCC Rules. These limits are designed to provide reasonable protection against harmful interference in a residential installation. This equipment generates, uses, and can radiate radio frequency energy and, if not installed and used in accordance with the instructions, may cause harmful interference to radio communications. However, there is no guarantee that interference will not occur in a particular installation. If this equipment does cause harmful interference to radio or television reception, which can be determined by turning the equipment off and on, the user is encouraged to try to correct the interference by one or more of the following measures:

- Reorient or relocate the receiving antenna.
- Increase the separation between the equipment and receiver.
- Connect the equipment into an outlet on a circuit different from that to which the receiver is connected.
- Consult the dealer or an experienced radio/TV technician for help.

Information to User

Alteration or modifications carried out without appropriate authorization may invalidate the user's right to operate the equipment.

CAUTION

- * Use of controls or adjustments or performance of procedures other than those specified herein may result in hazardous radiation exposure.
- * The use of optical instruments with this product will increase eye hazard.

CAUTION:

This product satisfies FCC regulations when shielded cables and connectors are used to connect the unit to other equipment. To prevent electromagnetic interference with electric appliances such as radios and televisions, use shielded cables and connectors for connections.

[For Canadian model]

This Class B digital apparatus meets all requirements of the Canadian Interference-Causing Equipment Regulations.

[Pour le modèle Canadien]

Cet appareil numérique de la Classe B respecte toutes les exigences du Règlement sur le matériel brouilleur du Canada.



Dear Customer:

Selecting fine audio equipment such as the unit you've just purchased is only the start of your musical enjoyment. Now it's time to consider how you can maximize the fun and excitement your equipment offers. This manufacturer and the Electronic Industries Association's Consumer Electronics Group want you to get the most out of your equipment by playing it at a safe level. One that lets the sound come through loud and clear without annoying blaring or distortion-and, most importantly, without affecting your sensitive hearing.

Sound can be deceiving. Over time your hearing "comfort level" adapts to higher volumes of sound. So what sounds "normal" can actually be loud and harmful to your hearing. Guard against this by setting your equipment at a safe level BEFORE your hearing adapts.

To establish a safe level:

- * Start your volume control at a low setting.
- * Slowly increase the sound until you can hear it comfortably and clearly, and without distortion.

Once you have established a comfortable sound level:

- * Set the dial and leave it there.

Taking a minute to do this now will help to prevent hearing damage or loss in the future. After all, we want you listening for a lifetime.

POWER-CORD CAUTION

Handle the power cord by the plug. Do not pull out the plug by tugging the cord and never touch the power cord when your hands are wet as this could cause a short circuit or electric shock. Do not place the unit, a piece of furniture, etc., on the power cord, or pinch the cord. Never make a knot in the cord or tie it with other cords. The power cords should be routed such a way that they are not likely to be stepped on. A damaged power cord can cause a fire or give you an electrical shock. Check the power cord regularly. When you find it damaged, ask your nearest FOSTEX authorized service station or your dealer for a replacement.

We Want You Listening For A Lifetime

Used wisely, your new sound equipment will provide a lifetime of fun and enjoyment. Since hearing damage from loud noise is often undetectable until it is too late, this manufacturer and the Electronic Industries Association's Consumer Electronics Group recommend you avoid prolonged exposure to excessive noise. This list of sound levels is included for your protection.

Decibel Level Example

30	Quiet library, soft whispers
40	Living room, refrigerator, bedroom away from traffic
50	Light traffic, normal conversation, quiet office
60	Air conditioner at 20 feet, sewing machine
70	Vacuum cleaner, hair dryer, noisy restaurant
80	Average city traffic, garbage disposals, alarm clock at two feet.

THE FOLLOWING NOISES CAN BE DANGEROUS UNDER CONSTANT EXPOSURE

90	Subway, motorcycle, truck traffic, lawn mower
100	Garbage truck, chain saw, pneumatic drill
120	Rock band concert in front of speakers, thunderclap
140	Gunshot blast, jet plane
180	Rocket launching pad

Information courtesy of the Deafness Research Foundation.



CAUTIONS REGARDING HANDLING

Location

Install the compact disc recorder in a well ventilated location where it will not be exposed to high temperatures or humidity. Do not install it in any location that is exposed to direct rays of the sun, or near stoves or radiators. Excessive heat can adversely affect the cabinet and internal components. Installation of the player in a damp or dusty environment may also result in a malfunction or accident. (Avoid installation near cooking stoves etc., where the player may be exposed to oily smoke, steam or heat.)

Do not install the compact disc recorder on an unstable or inclined surface.



Precautions regarding installation

- * Placing and using the CR200 for long periods on heat generating sources such as amplifiers will affect performance. Avoid placing the compact disc recorder on heat generating sources.
- * Install the CR200 as far as possible from tuners and TV sets. A compact disc recorder installed in close proximity to such equipment could cause noise or degradation of the video signal.
- * This may be particularly noticeable when an indoor antenna is used.
- * Please place the CR200 on a level surface.

Cleaning the CR200

To clean the compact disc recorder, wipe with a soft, dry cloth. For stubborn dirt, wet a soft cloth with a mild detergent solution made by diluting one part detergent to 5 or 6 parts water, wring well, then wipe off the case. Then, use a dry cloth to wipe the surface dry. Do not use volatile liquids such as benzene or thinner which are harmful to the CR200's case.

Storing discs

- * Discs are made of the same kinds of plastic used for conventional analog audio records. Be careful not to allow discs to warp; always store discs in their cases vertically, avoiding locations with high heat or humidity, or extremely low temperatures. Avoid leaving discs in cars, since the seat of a car in direct sunlight can become very hot.
- * Always read and abide by the precautionary notes listed on disc labels.

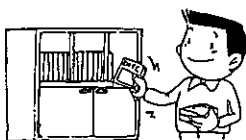

Never move the CR200 during recording/playback

The disc rotates at a high speed during recording and playback. Do not lift or move the CR200 during these operations, otherwise the disc may be damaged or recording will be interrupted.

CD lens cleaner

The compact disc recorder's pickup lens should not become dirty in normal use, but if for some reason it should malfunction due to soiling, consult your nearest FOSTEX authorized service station. Lens cleaners for compact disc recorders are commercially available, but special care should be exercised in their use since some may cause damage to the lens.

Condensation

When the CR200 is brought into a warm room from previously cold surroundings or when the room temperature rises sharply, condensation may form inside, and the CR200 may not be able to attain its full performance. If this occurs, allow the CR200 to stand for about an hour or raise the room temperature gradually.

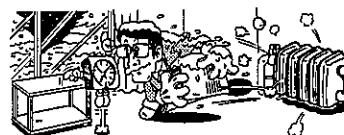

Cleaning and handling compact discs

- * Wet discs cannot store recorded information. The presence of fingerprints or smudges on the surface of the disc will not directly affect the recorded signals, but depending on the degree of contamination, the brightness of the light reflected from the signal surfaces may be reduced, causing degradation of sound quality. Always keep your discs clean by wiping them gently with a soft cloth from the inner edge toward the outer periphery.



- * If a disc becomes very dirty, dip a soft cloth in water, and after wringing it out well, wipe the dirt away gently, and then remove any water drops with another soft, dry cloth.
- * Do not use record cleaning sprays or anti-static agents on discs. Also, never clean discs with benzene, thinner, or other volatile solvents, since damage to the disc surface may result.



FEATURES

CD-R

The CR200 can be used to record signals on a CD-R (CD-Recordable) disc.

Once recorded, the signals on the CD-R disc cannot be erased.

The CD-R disc provides high sound quality and excellent durability similar to an ordinary CD (Compact Disc).

CD-R and CD compatibility

Playback of CD-R and CD discs

The CR200 can be used to play a CD-R disc which has been recorded on till the middle, CD-R discs which has been finalized, and ordinary prerecorded CD discs.

Creation of CD-compatible discs

A CD-R disc can be played on any CD player just like ordinary prerecorded CD discs, provided that it has been finalized (by recording TOC) after recording.

Sampling frequency converter

When recording a digital source that uses a 32 kHz or 48 kHz sampling frequency such as satellite broadcasting, DAT and DCC, the CR200 automatically converts the sampling frequency to 44.1 kHz, which is the sampling frequency used for the CD.

However, the digital monitoring signal which is output during recording by the CR200 is based on the same sampling frequency as the recorded source.

1-bit A/D converter

The A/D converter (analog-to-digital converter) of the CR200 uses the latest 1-bit conversion system, which provides the following advantages compared to previous systems.

- Zero-cross distortion from the principle.
- Non-linear distortion throughout the frequency band.
- High accuracy is possible without adjustment.

These features preserve the original quality of the music including low level signals.

Newly-developed three beam differential push pull pickup

The new three beam pickup with a differential push pull system stabilizes operations and reproduces rich low and medium frequencies.

Direct construction with short signal paths and separated digital and audio

Direct construction reduces cross interference between signals. It reproduces musical signals purely by eliminating distortion, separating channels, and level linearity values. These improvements cover not just one point, but a wide frequency range.

Digital source synchro recording modes

When recording digital signals from a CD, DAT, MD or DCC, recording on the CR200 can be started and stopped in synchronism with the starting and stopping of the playback of the source component.

A mode for synchro recording of a single track from the above mentioned sources is available for easy edited recording.

Stable platter mechanism ensure stable playback

The platter supports the whole disc surface to reduce resonance or sagging of the disc. This allows stable performance with resistance to load variations.

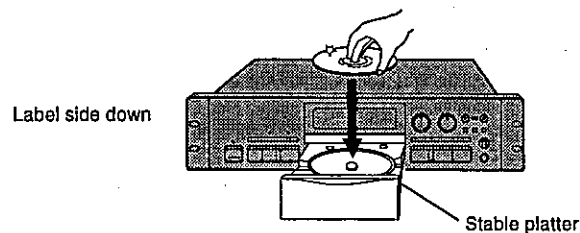

Features Copy Bit

CD-R discs can be made by selecting one of the following three modes:

- Disc without copy prohibition (Copy Bit = 1)
- One-time-copy disc (Copy Bit = 0)
- Copy prohibited disc (Copy Bit = 1/0)

Complies to standard EIA rack

The mounting holes on both left and right ends of the front panel comply to 19 inch EIA standard racks. Use standard 3/16" diameter, 3/8" long screws sold in hardware stores for installation.

CHECKING ACCESSORIES

Audio cables ... x 2
(analog recording input, analog playback output)

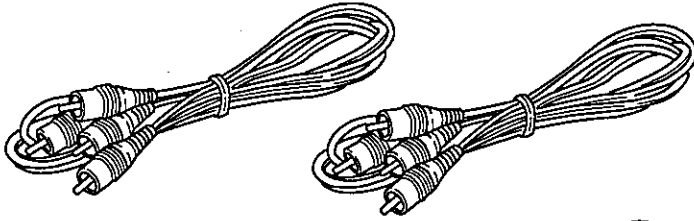

Power cable ... x 1

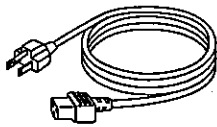

Remote control unit (Model 8317)

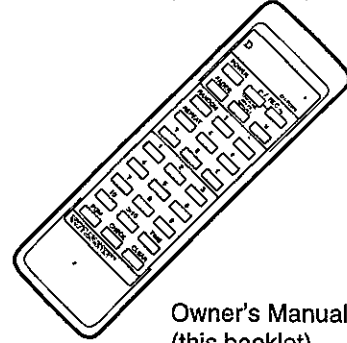

Owner's Manual
(this booklet)

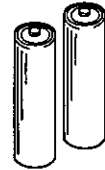

AAA/R03 dry cell batteries ... x 2

Loading batteries in the remote control unit Model 8317

Battery loading method

- * Remove the battery cover on the rear, insert 2 batteries matching the polarities (+, -) to the indications in the compartment and replace the cover.

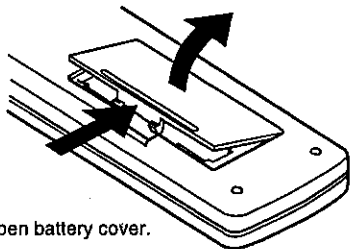

Open battery cover.

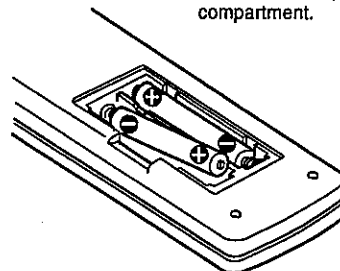

Insert batteries according to the indications (+, -) in the compartment.

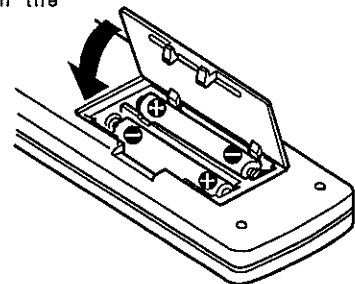

<Caution on batteries>

- * Load batteries with correct + and - orientations as indicated inside the battery compartment.
- * Do not mix new and used batteries.
- * Even when two batteries have the same shape, their rated output voltages may sometimes differ. Therefore, do not mix different brands of batteries.

2 batteries (AAA/R03 dry cell batteries)

- * Some batteries are rechargeable while some are not. Read the instructions indicated on the batteries carefully before use.
- * Battery life is about six months under normal use. Remove the batteries when the remote control unit is not to be used for a long period (more than 1 month).
- * If the batteries leak, wipe the inside of the battery compartment well, and then load new batteries.

DISCS

Discs usable with the CR200

* CD-R disc

■ When recording signals on a CD-R disc with the CR200, be sure to use the disc carrying the following mark and indication.



■ Although recording characteristics for CD-R's are specified in the industry specification, recording quality might differ between CD-R disc manufacturers.

If a CD-R disc (CD-ROM) recorded with computer data is played back in the CR200, no signal will be output. These discs will be identified by alternate display of "time" and "ROM."

* CD disc

■ The CD disc used with the CR200 should be a disc carrying the following mark (Compact Disc - digital audio with optical recording).



Notes on the copyright

- * Broadcast programs, records, other recording media (music tapes, cassettes, CD discs, etc.) and musical performance are protected by copyright law the same as the lyrics and melodies of songs.
- * Therefore, copyright laws dictate that permission must be obtained from the copyright owner if you sell, transfer, distribute or lease a disc recorded from the above mentioned sources or if you use it in business (including background music in your store).

In order to play a recorded CD-R disc on an ordinary CD player, the disc must be subjected to a process called finalization.

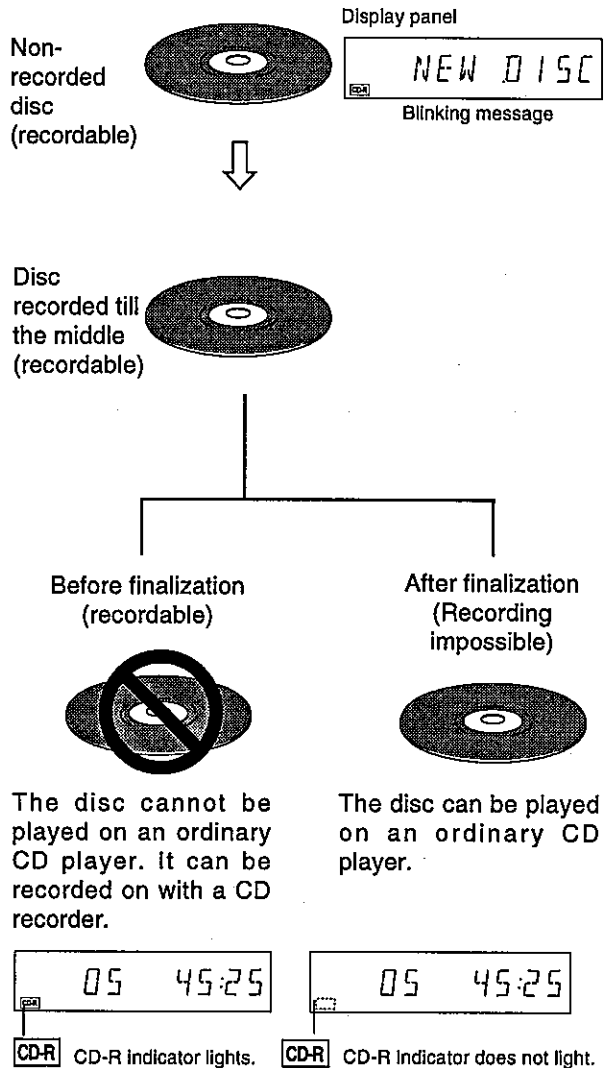

CAUTION

After finalization;

- * additional recording is not possible.
- * setting or clearing of skip IDs is not possible. (Refer to p. 30 of the Operating Instructions.)

DISCS

Handling of a disc

- When holding a CD-R or CD disc, be careful not to leave a fingerprints, dirt or scratches on the signal recording side. Hold the disc by placing your fingers on the edge or across the center hole and edge. A disc with fingerprints, dirt or scratches can become unusable for recording or playback.

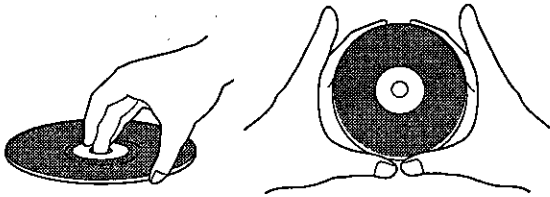

- Be careful not to scratch the label side. A scratched disc can be unusable for recording or playback.
- * Do not stick paper or seals on the label surface. Make sure the label surface is not scratched or damaged. Scratched or damaged surfaces can result in playback or recording failure. Use only a felt pen sold on the market or similar pen to write on the label. Never use a writing instrument with a hard point (ballpoint pen, pencil, etc.), as this will damage the disc.

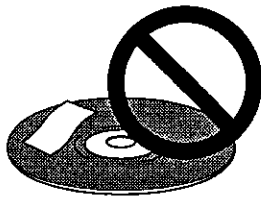

- The disc rotates at a high speed inside the player. Do not attempt to use a damaged disc (cracked disc, extremely warped disc, etc.).

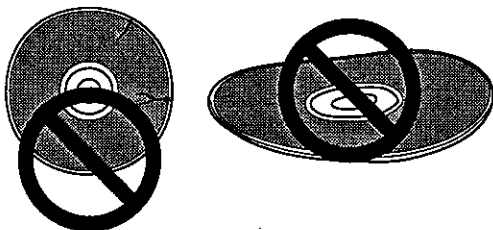

Disc maintenance

- * When a disc is smudged with fingerprints or dust, the signal recorded on the disc itself is not affected but this could degrade the sound quality by reducing the brightness of the light reflected from the signal recording side. Therefore, always try to keep the disc surface clean. For cleaning, use a soft cloth that is either dry or soaked in alcohol and wipe with a light force in straight directions from the center toward the edge.



Do not wipe in a circular direction.

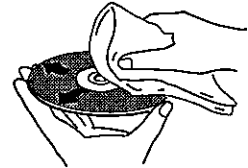

Wipe lightly from the center toward the edge.

- * For disc cleaning, we recommended you use a disc cleaning kit sold on the market.
- * Do not use record spray or anti-static agent. Also take care that volatile chemicals such as benzine and thinner do not spill on the disc, for these substances may corrode the surface.

Disc storage

- * The CD-R and CD discs are made of plastic just like analog record. When storing a disc, take care that it does not warp. Always put it in its case and stand the case upright and avoid places subject to direct sunlight, high temperatures, high humidity and extremely low temperatures. Don't leave the case on a car seat because a seat in direct sunlight can become very hot.
- * Be sure to read the instructions provided with the disc.

CONNECTION WITH PROFESSIONAL EQUIPMENT

Before connecting the CR200 with other equipment, unplug the power cord from the wall outlet.

Balanced connection

These are connected with equipment having balanced input/output connectors. Balanced output connections are employed in studios and broadcasting stations because they are least affected by external induction noise. We recommend Canon connectors (XLR-3-12C or equivalent) commonly sold in electronic stores.

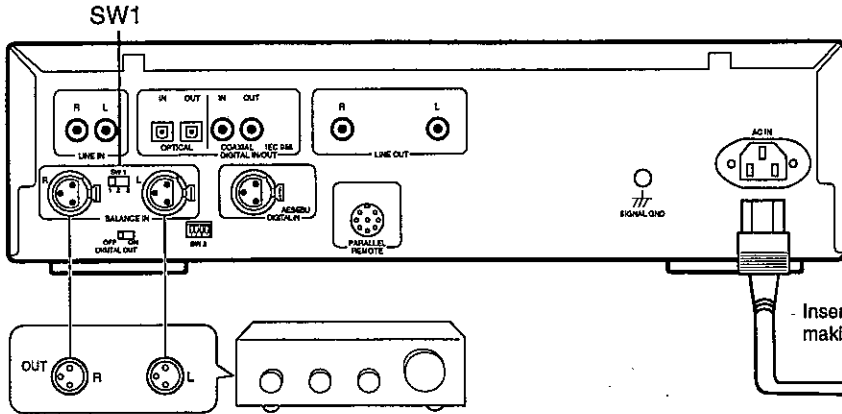

NOTE:
Series connection of a number of CR200s is not recommended.

Insert the power cable into the wall outlet only after making all interconnections between equipment.

Slide switch (SW 1)

	Side 1: Set to this position when using the LINE Input.
	Side 2: The standard input level is +4dBu. This position is selected when using inputs from professional equipment.
	Side 3: The standard input level here is -10dBV (-8dBu).

AES/EBU digital signal connection

This connection method complies with the digital signal AES/EBU specification employed in professional studios and broadcasting stations. We recommend Canon connectors (XLR-3-12C or equivalent).

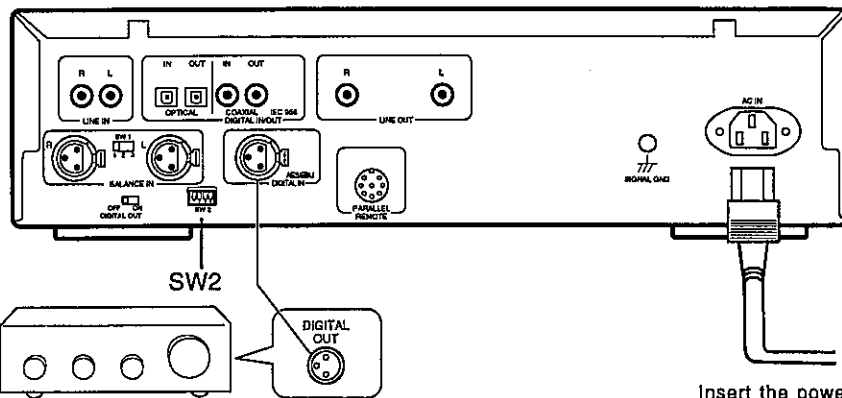

NOTE:
Series connection of a number of CR200s is not recommended.

XLR connecting cable

Purchase a balanced line 3 pin XLR connecting cable. The CR200 employs the European type pin assignment (Pin 2 hot, Pin 3 cold). If any equipment to be connected employ the American type pin assignment, change the cable pin connections accordingly (If connections are incorrect, either the phase will be reversed or no sound will be heard).

Insert the power cable into the wall outlet only after making all interconnections between equipment.

European type

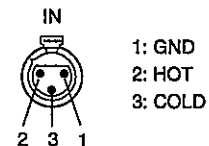

How to set digital copy permission/prohibition when making a disc.

This is set by SW2 of the DIP switches. Three settings can be obtained by different combinations of SW3 and SW4 as listed below.

3	4	Copy bit indicator	Copy content
ON	OFF	Light	Hereafter, unlimited digital copy is possible (1).
ON or OFF	ON	Off	Hereafter, digital copy is possible for one time (0).
OFF	OFF	Blink	Hereafter, digital copy is prohibited (1/0).

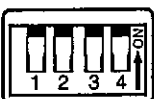

The COPY BIT indicator during recording

The COPY BIT indicator will show the copy content only when the CR200 is in the record pause mode. The indicator is automatically extinguished when recording is started. (Refer to pages 18-23.)

Canon connector insertion method

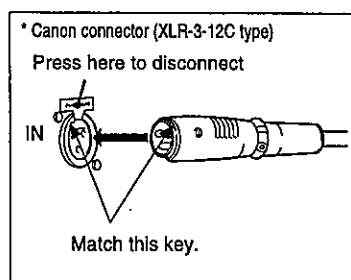

CONNECTION WITH OTHER EQUIPMENT (1) DIGITAL CONNECTION

Digital signal connection

(Before connecting the CR200 to other equipment, unplug the power cord from the wall outlet.)

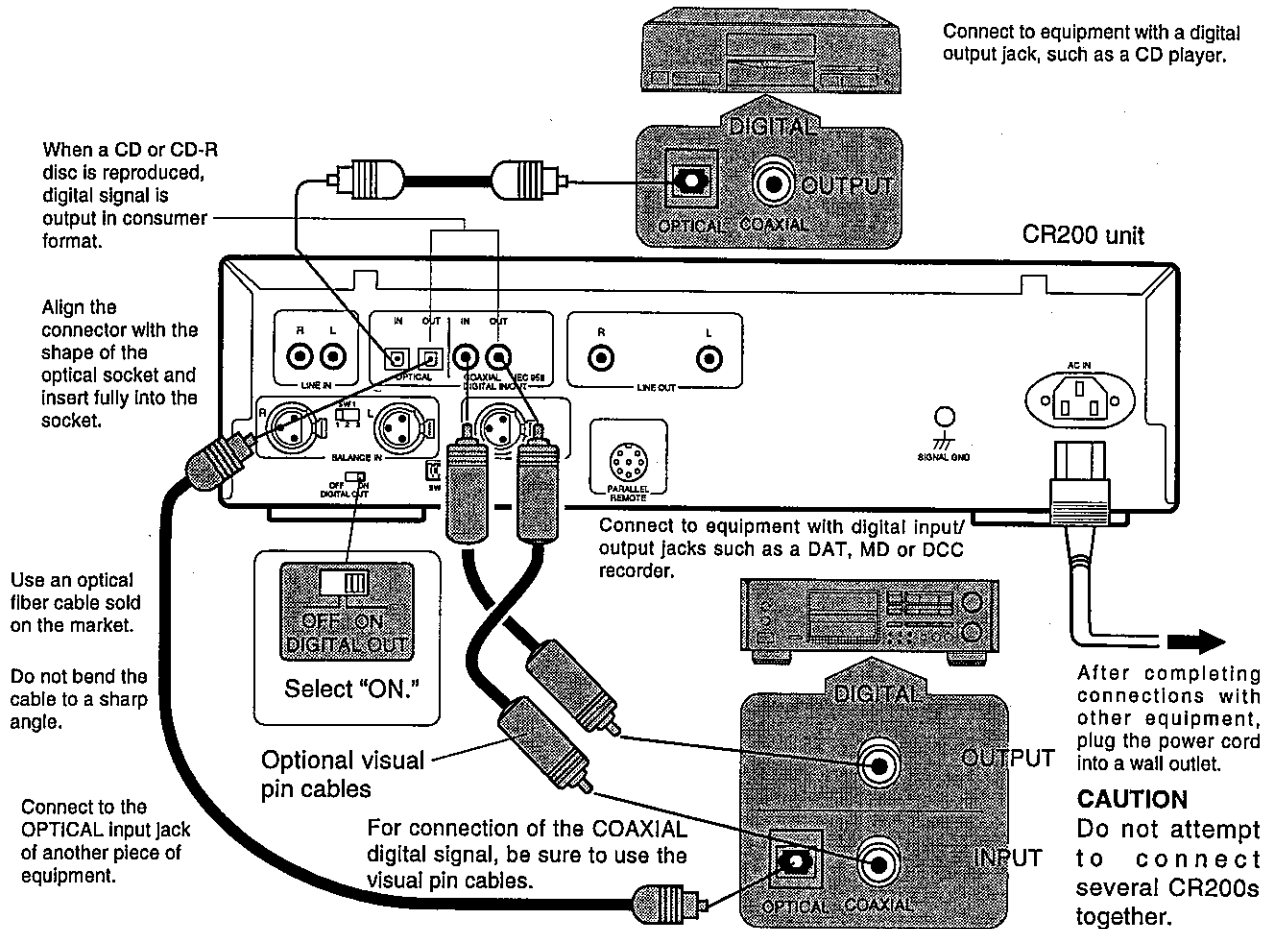

Caution in use of optical fiber cables

- * Do not bend an optical fiber cable to a sharp angle, as this could damage the cable. Be especially careful when mounting the CR200 in a rack, etc. When an optical cable is stored in the form of a loop, the loop should have a diameter larger than 15 cm (6 in.).
- * An optical cable should be inserted deep into the socket. Avoid incomplete connection.
- * Use optical cables with a length of no more than three meters (10 feet).
- * Be careful not to leave dust on or scratch the optical fiber cable plugs. If the plug is dusty, wipe with a soft cloth before connecting.
- * When optical fiber cables are not connected, protect the OPTICAL sockets on the rear of the CR200 against dust by inserting dust protective caps.

Digital input/output (coaxial) terminal cap

- * Remove the black cap before using the digital input/output terminal.
- * Be sure to replace the black cap when not using the terminal.

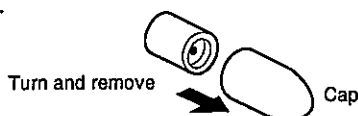

Optical sockets are delicate!!

- * When the OPTICAL sockets are used, pull out the dust protective caps from them. Be sure to insert them again when the OPTICAL sockets are not to be used.

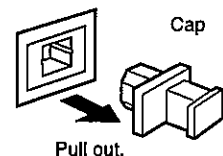

- * Don't lose the dust protective caps.

How to connect the AC power cable

Plug the AC power cord into the CR200 and plug the other end into the wall outlet. If the wall outlet is a 3 prong type (provided with grounding terminal), the power cable can be plugged directly. In the case of a two prong type, use a conversion adaptor before plugging in. Electric shock can be prevented and the equipment safer if the grounding lead wire is connected to a grounding terminal.

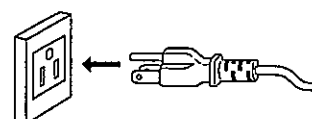

Hum and other noise could occur when the CD-R is grounded at the same place as the amplifier. In such a case, disconnect the ground wire from either piece of equipment.

CONNECTION WITH OTHER EQUIPMENT (2) ANALOG CONNECTION

Analog signal connection

(Before connecting the CR200 with other equipment, unplug the power cord from the wall outlet.)

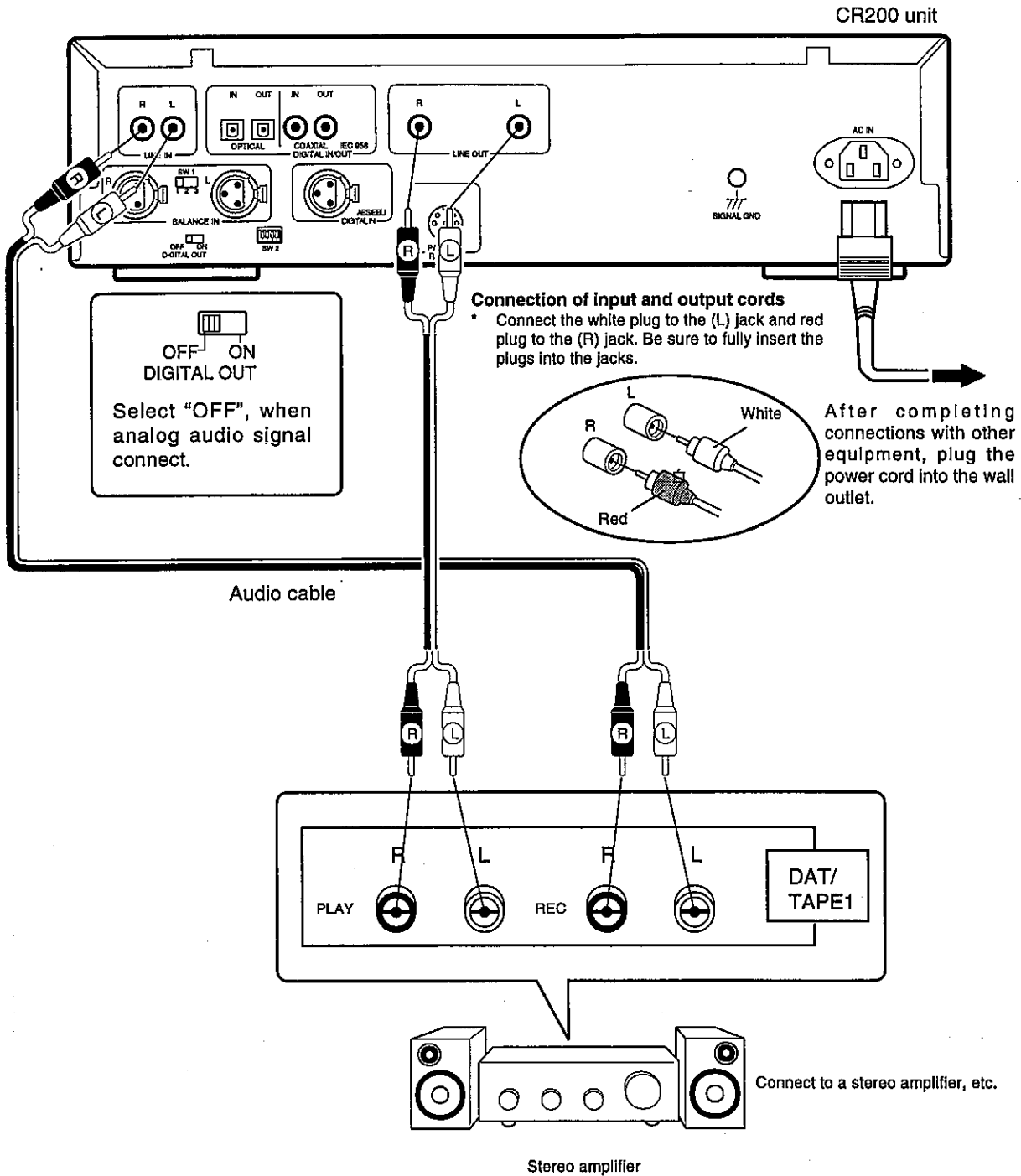

NAMES AND FUNCTIONS (FRONT PANEL)

Operations using buttons marked ★ are also available with the same names or inscriptions on the remote control unit. (See p. 14)

TRACK SKIP button (SKIP SET, CLEAR)
(See page 30 to 31.)

SKIP PLAY ON/OFF button
(See page 33.)

★Record muting button
(REC MUTE)

★Record button (REC)
★Record indicator

REC LEVEL control
(See page 22.)

REC BALANCE control
(See page 22.)

Display panel
(See page 15.)

Remote control sensor

Copy Bit indicator
(See page 10.)

★TRACK NO. write button
(AUTO/MANUAL, WRITE)
(See page 29.)

Power indicator

★Track search buttons (|<</>>|)
Manual search buttons (<</>>)

Headphone level control
(PHONES LEVEL)

Headphones jack
(PHONES)

★Play button

★Pause button

OPEN/CLOSE button

Stop button

Disc tray

★TIME button
(See page 15, 27.)

FINALIZE button
(See page 24.)

DIGITAL SYNCHRO button
(See page 18 to 20.)

INPUT SELECTOR button
(See page 17.)

Power switch
(POWER)

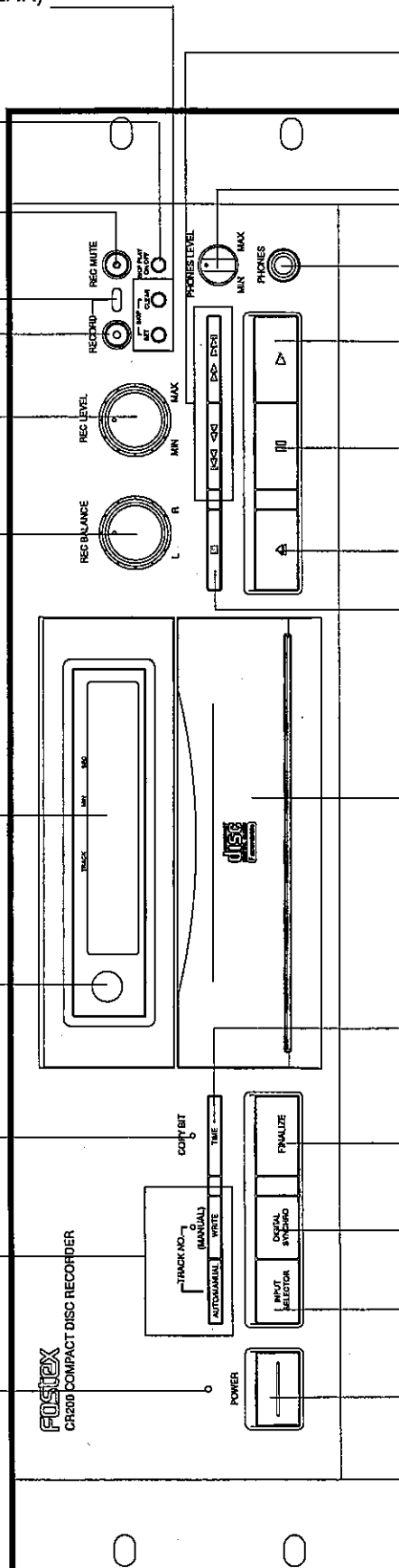

NAMES AND FUNCTIONS (REMOTE CONTROL UNIT)

Functions of the remote control unit

* Operations performed by buttons marked ★ can also be carried out by using buttons with the same name on the CR200. (See p. 13)

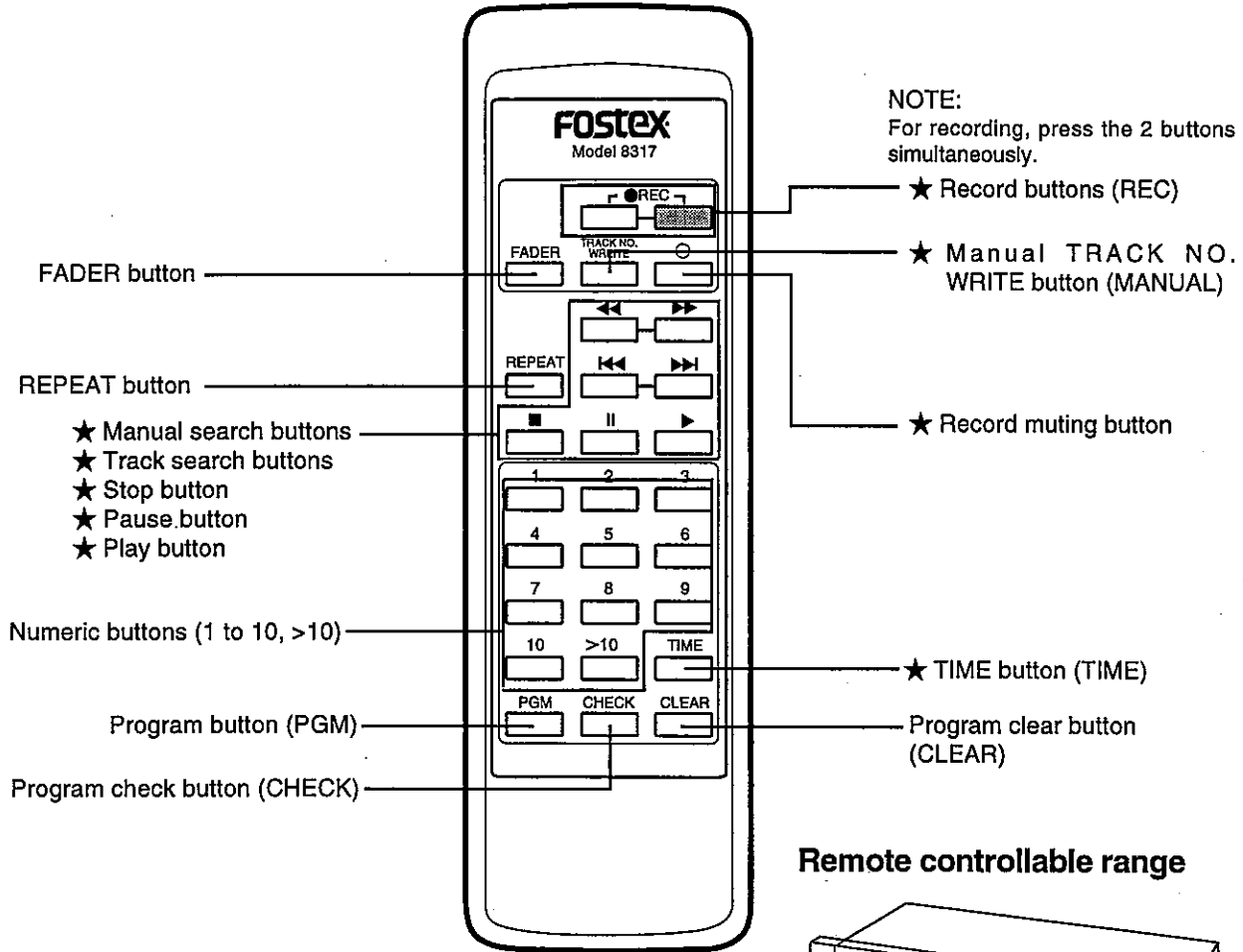

Remote controllable range

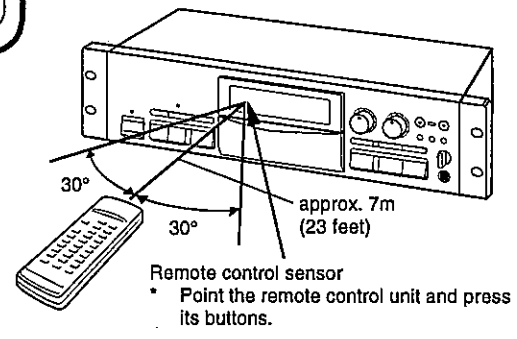

Remote control operation

The CR200 can be controlled through the rear panel eight pin parallel remote control input connector and also with the wireless remote controller included with the CR200. Acceptance of commands from the wireless remote controller by the CR200 can be set by the rear panel SW2 of DIP SW2.

2	Operation
ON	Accepted
OFF	Denied

The eight pin parallel remote controller input connector (DIN 8 pin)

The CR200 can be controlled with external switches by utilizing the circuit shown below. The parallel remote controller has priority over the wireless remote controller. Should it be simultaneously pressed together with the wireless remote controller, the parallel remote controller function will have priority.

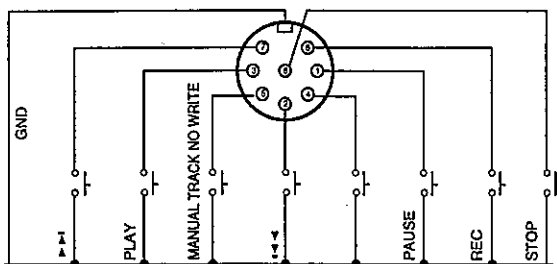

Caution on the remote control operation

- * Remote control might not work if there is an obstacle between the remote control unit and the CR200 or if the remote control unit is operated at too great of an angle from the remote control sensor.
- * Erroneous operation may occur in strong light such as direct sunlight or fluorescent lamp light shining into the remote control sensor.
- * The CR200 may operate erroneously if it is used near equipment radiating infrared rays or if the infrared remote control unit of other equipment is used near the CR200. On the contrary, if this remote control unit is operated near another piece of equipment which can be controlled with infrared rays, that equipment might not work correctly.
- * Replace batteries when the remote controllable range decreases noticeably.

DISPLAY PANEL

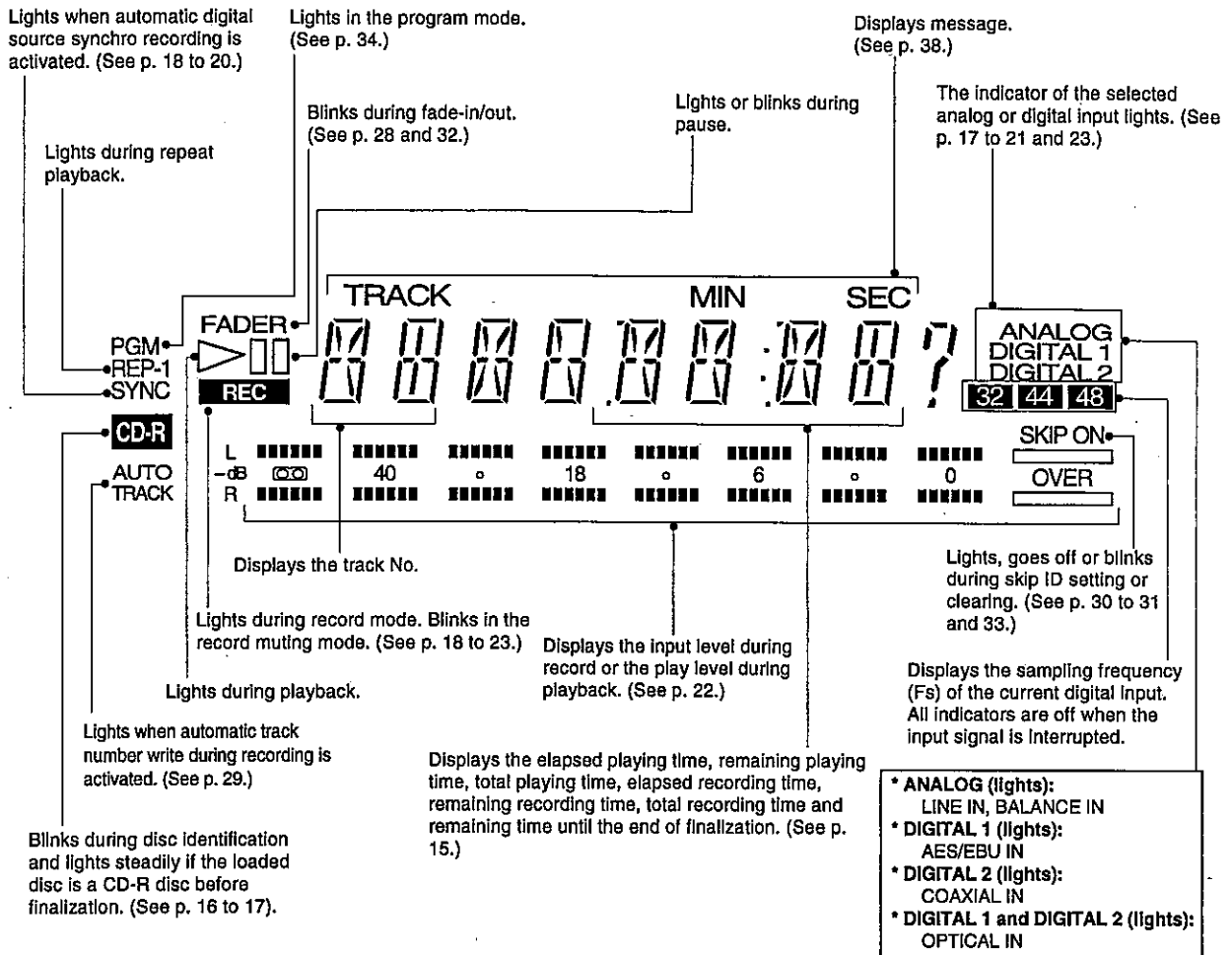

Switching the time display (Remote control unit)

The following operation allows you to check the recording time information during recording or playing time information during playback. Every time the TIME button of the remote control unit is pressed, the time information contents are switched in order of A -> B -> C -> D.

The display mode varies depending on whether the current operation is recording or playing back (in order of A -> B -> C during recording).

During recording

A : Elapsed recording time
(2 min. 16 sec. after the start of track No. 1)

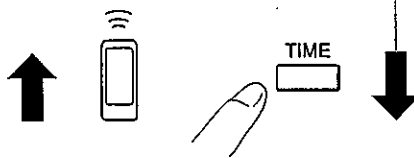
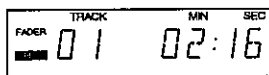

C : Total recording time
(3 min. 50 sec. of 1-track recording)

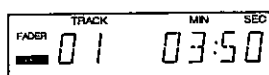

B : Remaining recording time
(59 min. 13 sec. remaining on the disc)

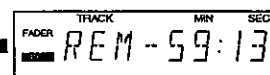

During playback

A : Elapsed playing time
(2 min. 16 sec. after the start of track No. 1)

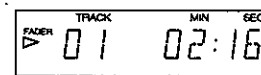

B : Remaining playing time of track being played (3 min. 20 sec. remaining for track No. 1)

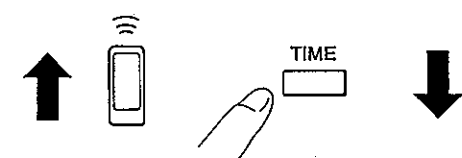
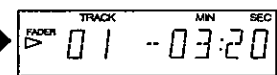

D : Total playing time
(60 min. 0 sec. for 8 tracks)

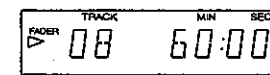

C : Remaining playing time of all tracks on disc being played (46 min. 40 sec. remaining on the disc)

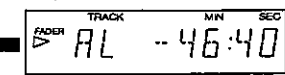

DISC LOADING/UNLOADING

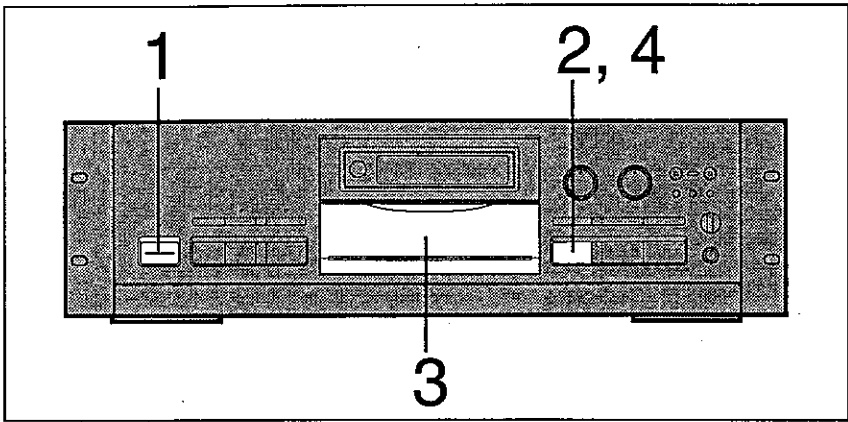

Loading/unloading a disc

1 Turn the power ON.

2 Open the disc tray.

3 Place a disc.

4 Close the disc tray.

* After recording or skip information recording, it takes a few seconds before the disc can be unloaded because the recording information is written on the disc. "OPEN" blinks in this period.

* Label side down.

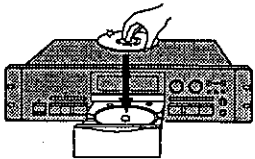

The disc tray can also be closed by:

- * pressing the play button.
- * gently pushing the disc tray.

* When a disc is loaded, the disc type is identified and the information on the disc is read out. (In this period, "CD?" and "CD-R?" are displayed alternately.)

Display for a non-recorded CD-R disc:  NEW DISC

Display for a CD-R disc till the middle:  10 43:12

The total recording time is displayed.

Display for a prerecorded CD or finalized CD-R disc:  Not displayed 11 55:37

The total playing time is displayed.

Playback attempted without loading a disc: NO DISC

MODES OF RECORDING

This section introduces a summary of the modes of recording available with the CR200.

* We recommend that you use the automatic digital source synchro recording when recording a CD, DAT, MD or DCC source. Track numbers are updated automatically by the CR200.

For details, refer to the corresponding descriptions.

There are five different methods to make a CD-R disc with the CR200. Three of these are by automatic digital recording. The mode will sequentially switch to OFF -> One track -> All tracks -> DAT exclusive -> OFF with each press of the DIGITAL SYNCHRO button. The proper mode should be selected according to the source to be recorded (The CR200 will switch to the "DAT exclusive" mode only when a DAT that can output consumer digital codes is connected, and will not switch for any other type of signals).

Automatic digital source synchro recording (1-track)

When the source equipment starts to play, only one track is recorded automatically and the recording stops automatically after that track. This mode is convenient for edited recording of a CD, DAT, MD or DCC. (Refer to page 18 for the recording setup procedure.)

Automatic digital source synchro recording (all-track)

When the source equipment starts to play, all tracks are recorded automatically and the recording stops automatically after the last track. This mode is convenient for recording an entire CD, DAT, MD or DCC. (Refer to page 19 for the recording setup procedure.)

Automatic digital source synchro recording (DAT exclusive)

When the DAT is started in playback, all tracks are recorded automatically and upon ending playback, recording is automatically stopped. Because the track number is renewed according to the DAT start ID, this is a convenient feature when whole recording of a DAT source. This feature will function only in a DAT which can output consumer digital codes (For setup method, refer to page 20.)

Manual digital source recording

This mode is mainly used for recording the output from digital sources other than those mentioned above. Recording is started or stopped manually. (Refer to page 23 for the recording setup procedure.)

Analog source recording

This mode is used for recording from the line output of the source equipment. (Refer to page 21 for the recording setup procedure.)

Recorded input can be monitored.



The ANALOG, AES/EBU, COAXIAL and OPTICAL indicator corresponding to the selected input will light.

When selection is made with the INPUT SELECTOR button, the playback unit names (only at input of digital signals) "INPUT" -> "CD" -> "OPT" -> "MONI" and the selected input (AES EBU, COAX, ANALOG) will be displayed.

* This display is available if the input source is a CD, MD, DAT or DCC.

<CAUTION>

The CR200 is a recorder for writable discs.

The **CD-R** indicator lights when a CD-R (Compact Disc - Recordable) disc is loaded. Recording on a disc which has been recorded till the middle starts from the point where the previous recording has been stopped.

The CD-R disc is recordable once and cannot be erased once it has been recorded.

In the following cases, recording is impossible even when the REC or DIGITAL SYNCHRO button is pressed.

When the CD-R indicator is not lit, input monitoring is started by pressing the button.

When there is no remaining recording time, "REC FULL" is displayed.

When 99 tracks have already been recorded, "REC FULL" is displayed. (No more recording is possible.)

When a CD-R disc is inserted, the CR200 automatically performs a series of adjustments designed to provide the best possible recording.

When the power to the CR200 is switched ON and REC button immediately pressed, in some cases "STANDBY" will be displayed and the CR200 may take some time to complete its automatic adjustments.

Please wait for the CR200 to enter the record standby mode.

Automatic digital recording will not function when a digital audio signal in the AES/EBU (professional) format is input. This automatic digital recording will function only for digital signal in the consumer format.

<Notes on automatic digital recording from a DAT tape>

When automatic digital recording from a DAT tape, switching of the track is detected from the start ID in the input source side. Therefore, to assure correct digital recording, be sure to use a source in which the start ID recorded on the DAT tape is located prior to start of the track. Should the start ID not be recorded in the correct position, correct automatic digital recording cannot be expected.

As an example, normally, in a tape made by utilizing the DAT AUTO-ID function, the start ID will be recorded slightly after the sound and therefore if such a tape is used for automatic digital recording, the following defects could occur.

At the start of recording : The head of the track will be lacking.

During recording : The track number will be renewed in the middle of the track.

At end of recording : Recording will start at the head of next track.

RECORDING (1) AUTOMATIC DIGITAL-SOURCE SYNCHRO RECORDING (1-TRACK RECORDING)

This function is convenient for track-by-track edited recording of a CD, DAT, MD and/or DCC.

The following procedure allows you to perform automatic digital source synchro recording.

* Connect the digital input/output properly as indicated (on page 11).

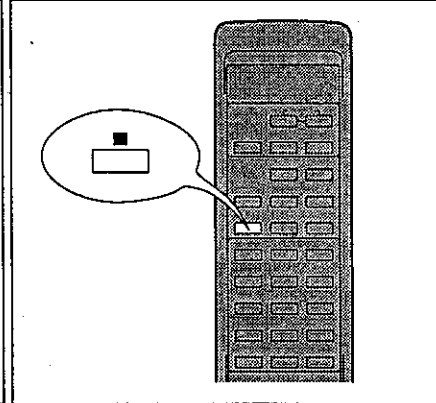
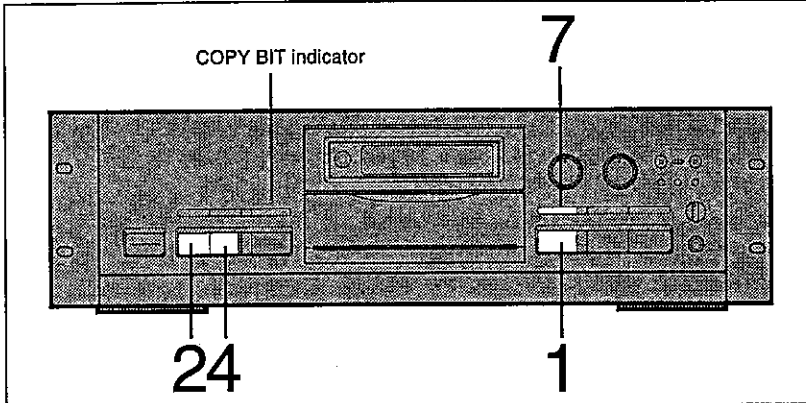

*** Before recording**

Set the digital copy permit/prohibit for the disc to be produced with the rear panel SW2 (Refer to page 10).

* Choose and set the digital copy permit/prohibit with the rear panel SW2 (Refer to page 10).

Be sure to set this before recording

(Even if SW2 is changed during recording, it will record according to the initial setting). Depending on the setup content, the COPY BIT indicator will be displayed as follows:

Lighted: Hereafter, digital recording is possible for any number of times.

Extinguished: Hereafter, digital recording is possible only once (Compliance to SCMS).

Blinking: Hereafter, digital recording is prohibited.

* After loading the disc, check that the **[CD-R]** indicator stops blinking and lights steadily. If it does not light steadily or a character display appears, refer to page 38.

* Confirm the track to be recorded before recording.

* Select **AES EBU, COAXIAL** or **OPTI**. The **ANALOG** input cannot be recorded with this function.

* After pressing the **DIGITAL SYNCHRO** button, check whether or not the input can be automatically digitally recorded, and if not, select another input. If there is no permissible input, analog input will be selected and the CR200 will stop.

* Wait until the **SYNC** indicator blinks.

* **Do not start the playback of the source player until the SYNC indicator starts to blink.**

* The CR200 will automatically enter the track number automatic renewal mode.

* The CR200 enters record-pause mode after one track recording.

* If the CR200 is switched to an unlocking source or a source not possible in automatic digital recording while SYNC is blinking or during one track synchro recording, the one track synchro mode will be canceled.

* Press the **STOP** button if you want to end recording.

* If the SYNC indicator is not lit after 1-track synchro recording, the track to be recorded next can be confirmed on the source player. (Automatic recording cannot be started while the SYNC indicator is not lit.)

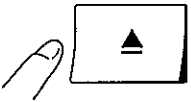
- 1 Load a CD-R disc containing a recordable space.
 

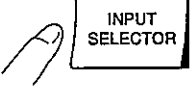
- 2 Select the input to be recorded with the **INPUT SELECTOR**. In doing so, check that "INPUT," "CD," ("MD," "DCC," "DAT") is displayed.
 

- 3 Ensure that the source player is not playing (in stop or pause mode). This function cannot be activated if the source is being played.

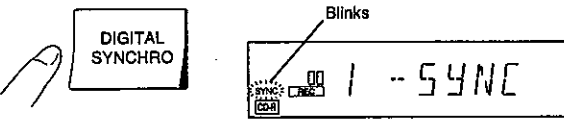
- 4 Press the **DIGITAL SYNCHRO** button.
 

- 5 Start playing the source player. The CR200 will start recording automatically.

- 6 One track recording will end, when the track changes to the next one in the case of CD/MD as the input source, or when detecting a start ID of the next track when the input source is DAT/DCC. One track recording will also end when no sound from the source continues for about 10 seconds. If the next track is to be after finishing one track recording, carry out procedures 3-5.

- 7 After recording the desired tracks, press the **stop** button to end recording.
 

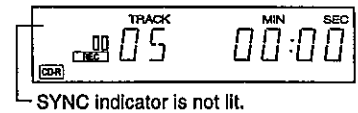

SYNC indicator is not lit.

RECORDING (1) AUTOMATIC DIGITAL-SOURCE SYNCHRO RECORDING (ALL-TRACK RECORDING)

This function is convenient for straight recording all tracks from CD, MD and DCC (DAT) players (automatic digital recording exclusively for DAT is convenient for signals from DAT that contain a start ID). Refer to page 20.

* Connect the digital input/output properly as indicated (on page 11).

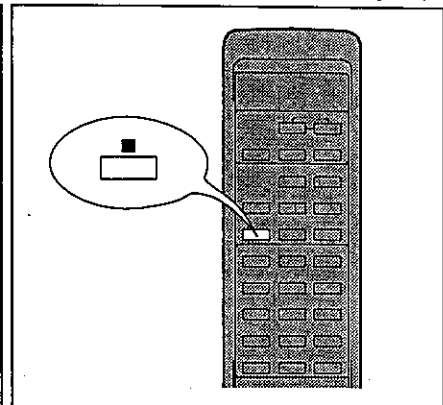
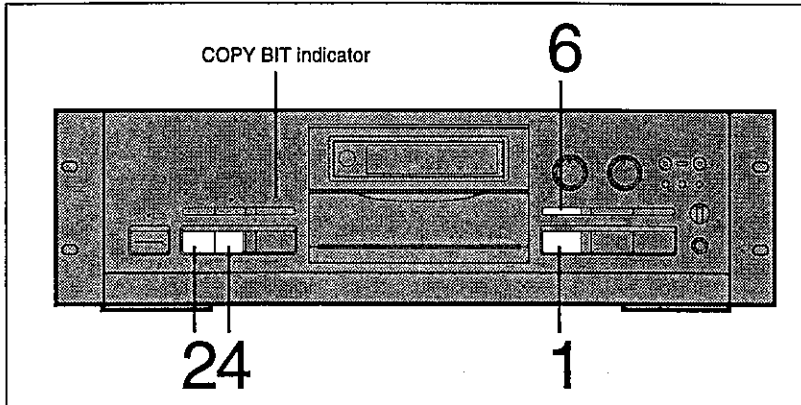

* Before recording

Set the digital copy permit/prohibit for the disc to be produced with the rear panel SW2 (Refer to page 10).

* Set the digital copy permit/prohibit for the disc to be produced with the rear panel SW2 (Refer to page 10).

Be sure to set this before recording

(Even if SW2 is changed during recording, it will record according to the initial setting). Depending on the setup content, the COPY BIT indicator will be displayed as follows:

Lighted: Digital recording is possible for any number of times.

Extinguished: Digital recording is possible only once (Compliance to SCMS).

Blinking: Digital recording is prohibited.

* After loading the disc, check that the **CD-R** indicator stops blinking and starts to light steadily. In case it does not light steadily or a character display (such as "Pro DISC") appears, refer to page 38.

* Select **AES EBU, COAX** or **OPTI**.
The **ANALOG** input cannot be recorded with this function.

* After pressing the **DIGITAL SYNCHRO** button, check to see if the input will automatically digitally record and if not, select another input. If there is no digital input, analog input will be selected and the CR200 will stop.

* Confirm the track to be recorded before recording.

* The CR200 will automatically enter the track number automatic renewal mode.

* If the CR200 is switched to an unlocking source or a source that won't record in automatic digital recording while **SYNC** is blinking, or during all track synchro recording, the all track synchro mode will cancel.

* **Do not start playback of the source player until the SYNC indicator starts to blink.**

* Every time the **DIGITAL SYNCHRO** button is pressed, the mode is changed in order of **1-SYNC -> AL-SYNC -> ID-SYNC -> Record-pause mode**. Select ***AL-SYNC*** when all-track recording is required.

* ***AL-SYNC*** is displayed again after playback. Take care not to restart playback of the source player with the CR200 in this condition, or recording will start again..

- 1** Load a CD-R disc containing a recordable space.

- 2** Select the input to be recorded with the **INPUT SELECTOR**.
In doing so, check that "INPUT," "CD," ("MD," "DCC," "DAT") is displayed.

- 3** Make sure that the source player is not playing (in stop or pause mode). This function cannot be activated if the source is being played.

- 4** Press the **DIGITAL SYNCHRO** button twice.

- 5** Start playing the source player.
The CR200 will record automatically.

- 6** After recording, press the **stop** button to end recording.

CAUTION:

- * Do not play a DAT or DCC on the source player with programmed playback, as this could cause incorrect writing of the track numbers. If programmed playback should be recorded, record each track separately using the 1-track recording procedure.
- * When synchro recording all tracks from DAT and DCC, track numbers will be renewed at the instant the first note is input succeeding detection of the start ID.
- * When synchro recording all tracks from CD or MD, track numbers are renewed when the playback side track changes if the player is in normal playback mode. The track number renews when the first tone is input after the track is changed during playback of the program.

RECORDING (1) AUTOMATIC DIGITAL SOURCE SYNCHRO RECORDING

(RECORDING OF THE TRACK NUMBER IN ACCORDANCE TO THE DAT START ID)

This function is convenient at the start of recording, and when renewing the track number in accordance to the DAT start ID (ID sync recording).

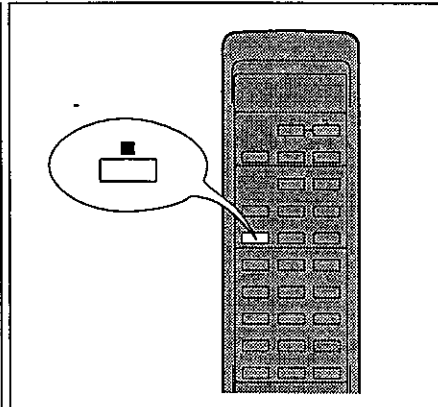
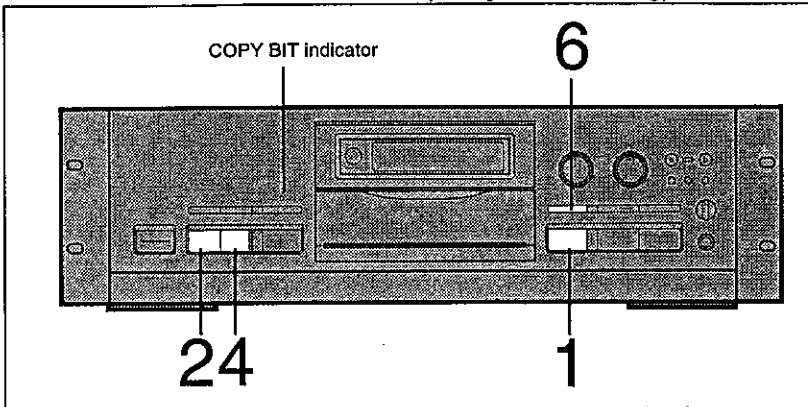

*** Please note the following items during ID sync recording**

- 1) During ID sync recording, check that the CR200 is stopped, and then set the DAT to the pause mode before the playback starting point.
- 2) Do not put the DAT in search mode when the CR200 is in ID sync recording pause mode (when the SYNC indicator in FL is blinking) or in the recording mode (*).
- 3) Do not playback the program of the playback side DAT (*).
- 4) Record a start ID before the beginning of any sound on the DAT tape.

Also, don't leave unnecessary start ID's on the tape.
 (*) In some DATs, the start ID can be output in the search mode which can cause mis-recording.

- * Connect the digital input/output properly as indicated (on page 11).
- * Set the digital copy permit/prohibit for the disc to be produced with the rear panel SW2 (Refer to page 10).

Be sure to set this before recording

(Even if SW2 is changed during recording, it will record according to the initial setting). Depending on the setup content, the COPY BIT indicator will be displayed as follows:

- Lighted:** Digital recording is possible for any number of times.
- Extinguished:** Digital recording is possible only once (Compliance to SCMS).
- Blinking:** Digital recording is prohibited.

- * After loading the disc, check that the **CD-R** indicator stops blinking and lights steadily. If it does not light steadily or a character display appears, please refer to page 38.
- * "INPUT" and "DAT" will be displayed only when a DAT which outputs consumer digital codes, is connected.
- * Select AES EBU, COAX or OPTI. ANALOG input cannot be recorded with this function.

- * After pressing the **DIGITAL SYNCHRO** button, check whether the input can be automatically digitally recorded or not, and if not, select another input. If there is no acceptable input, analog input will be selected and the CR200 will stop.

- * Confirm the track to be recorded before recording.
- * The CR200 will automatically enter the track number automatic renewal mode.
- * If the CR200 is switched to an unlocking source or a source not possible in automatic digital recording while SYNC is blinking or during ID synchro recording, the ID synchro mode will be canceled.

Do not start the playback of the source player until the SYNC indicator starts to blink.

- * Every time the **DIGITAL SYNCHRO** button is pressed, the mode is changed in order of **1-SYNC -> AL-SYNC -> ID-SYNC -> Record-pause** mode. Select "ID-SYNC" when ID synchro recording is required.

"ID-SYNC" is displayed again after playback. Be careful not to restart playback of the source player under this condition, or recording will start again.

- 1** Load a CD-R disc that contains recordable space.

- 2** Select the input to be recorded with the **INPUT SELECTOR**.

In doing so, check that "INPUT" and "DAT" are displayed.

- 3** Be sure that the DAT is not playing (in stop or pause mode). This function cannot be activated if the source is being played.

- 4** Press the **DIGITAL SYNCHRO** button three times.

- 5** Start playback of the DAT. The CR200 will start recording upon detecting a start ID. After ten seconds of no sound, the CR200 will enter the pause mode. If recording is to be continued, repeat step 5.

- 6** Press the **stop** button to end recording.

RECORDING (2) – ANALOG SOURCE RECORDING

This function is for recording the analog output such as analog records or compact cassette decks. * Connect the analog input/output properly as indicated (on pages 10 and 12).

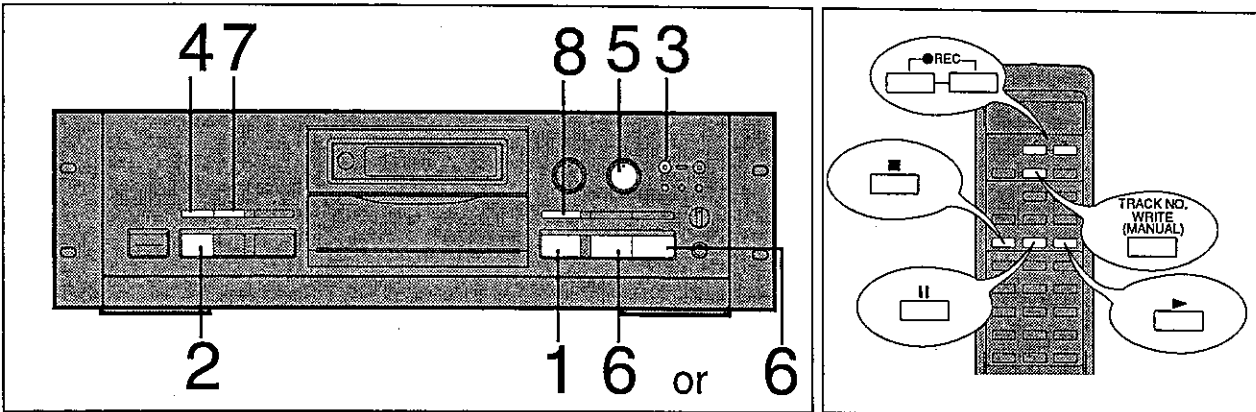

- 1** Load a CD-R disc that has recordable space.

- 2** Select the ANALOG input with the **INPUT SELECTOR**.

- 3** Press the **RECORD** button(s).

- 4** Select the track number "automatic renewal" or "manual renewal" with the **AUTO/MANUAL** button.

- 5** Adjust the recording level. (Refer to page 22 for the adjustment method.)

- 6** Press the **pause** or **play** button.

- 7** For manual renewal of the track number, press the **(MANUAL) WRITE** button (pressed when the track number is to be changed).

- 8** After recording, press the **stop** button to end recording.

- * Set the digital copy permit/prohibit for the disc to be produced with the rear panel SW2 (Refer to page 10).
- Be sure to set this before recording**
(Even if SW2 is changed during recording, the CR200 will record according to the initial setting). Depending on the setup content, the COPY BIT indicator will be displayed as follows:
Lighted: Digital recording is possible for any number of times.
Extinguished: Digital recording is possible only once (Compliance to SCMS).
Blinking: Digital recording is prohibited.
- * After loading the disc, check that the **CD-R** indicator stops blinking and lights steadily.
If it does not light steadily or a character display appears, please refer to page 38.
- * The CR200 enters record-pause mode.
- * Start playback of the source player.
- * Start playback of the source player after starting recording of the CR200.
- * Press if you want to renew the recorded track numbers during recording or between tracks. (For details, refer to page 29.)

RECORDING (2) – ANALOG SOURCE RECORDING

Recording level adjustment

* Adjustment reference

To record analog input, adjust the recording level so that the OVER-level indicator does not light even when the highest, or peak level is input. Otherwise, sound may be distort if the OVER-level indicator lights.

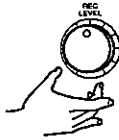

* Level meter

The level meter segments light to indicate the input level during recording or play level during playback.

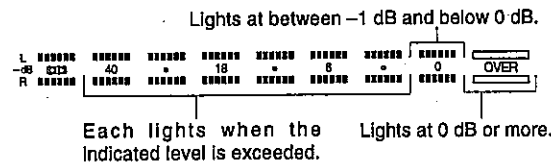

* Recording balance

The balance between the left and right volumes may be deviated depending on the recorded source or player. (The deviation can be identified if the acoustic image is not located on the center when the sound is played in monaural.) In such a case, fine adjust the recording balance toward R or L.

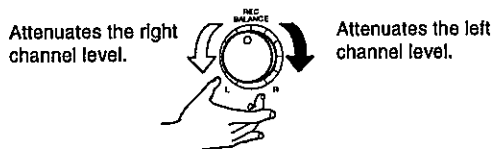

Track number write operation

Ordinary CD-digital audio contains recorded track numbers so that desired tracks can be selected and played. But, when recording with a CD-R recorder, you need to write the track numbers yourself. When recording from digital sources containing track number information (such as a CD, MD, DAT, or DCC), a new track number is recorded automatically when the CR200 detects a change track number information and sound from the digital source. When recording a source which does not contain track number information such as an analog source or satellite broadcasting (BS), you must write a new track number yourself between tracks. **(Be sure not to forget this for it is not possible to add track numbers once recording has been completed.)**

For track number write procedures, please refer to page 29.

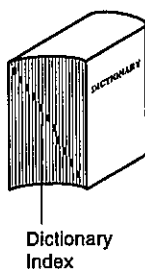

A CD contains track number information just like a dictionary contains an index.



Switching the detecting level for track number renewal by sound detection

Automatic renewal of the track number by sound detection can be accurately executed by adjusting detecting sensitivity for auto track number renewal.

1. Press the (MANUAL) WRITE button while in the stop mode. The present detecting level will be displayed (This is set to -60dB at shipping from the plant).

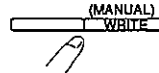

2. Select the desired level with the track search button. This can be set to six different levels: -∞dB, -80dB, -70dB, -60dB, -50dB and -40dB.



NOTE: "Rate setup -∞dB" will be written as "--dB."

3. Press the stop button.



NOTES

- The Detection level for auto track number renewal will be retained in memory after power is switched off.
- If set to -∞dB at analog input, the auto track number renewal will function at -80dB.
- Because this detecting level switching operates by sub codes in the case of equipment which are indicated as "INPUT" "--" when the INPUT SELECTOR button is pressed in the stop mode, the detecting level can be disregarded (Refer to pages 19 and 20).

The auto track number renewal detection level function can be checked when the CR200 is in the input monitor mode.

1. Press the INPUT SELECTOR button while in the stop mode. Then, check whether analog input is set or if digital input is displayed as "INPUT" "--" (category is not displayed). If automatic renewal of the track number is set for recording by this input, the track number will be renewed by sound detection.

2. After entering input monitor mode, press the TRACK NO. AUTO/MANUAL button to light up the AUTO TRACK indicator. Then, display the detecting condition of the track number renewal by referring to the MANUAL TRACK NO. indicator.

Extinguished:

A sound exceeding the sound detection level is being detected.

Lighted:

A sound below the sound detection level continues for about two seconds. This indicates standby for track number renewal.

Light -> extinguished:

This indicates that when a sound that exceeds the detection level is detected while the MANUAL TRACK NO. indicator is lit, the MANUAL TRACK NO. indicator will then be extinguished. The track number will be renewed at the time it is extinguished.

3. If the track number could not be renewed in step 2 above, switch to a different detection level for track number renewal and repeat from step 1.

NOTE

When the INPUT SELECTOR button is pressed in the stop mode and equipment (CD, CD-R, MD, DAT, DCC) indicated as "INPUT" "CD" ("MD," "DAT," "DCC) is digitally connected, automatic renewal of the track number will be done using sub codes. Therefore, the MANUAL TRACK NO. indicator will not function and will remain extinguished.

RECORDING (3) – MANUAL DIGITAL-SOURCE RECORDING

This function is for the recording of digital output of sources other than CD, DAT, MD and DCC.

(We recommended that you use automatic digital source synchro recording when recording signals from a CD, DAT, MD or DCC.)

This is also used when digital recording from digital equipment which do not output consumer digital codes.

- Connect the digital input/output properly as indicated (on page 10 and 11).

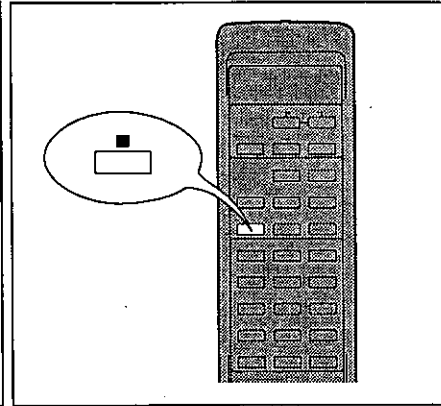
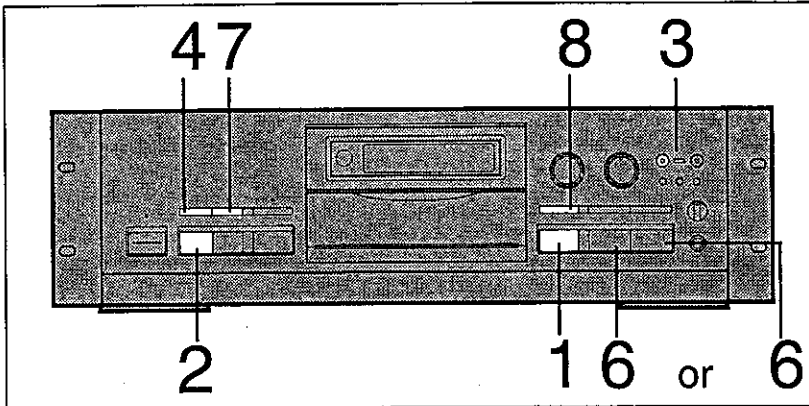

*** Before recording**

Set the digital copy permit/prohibit for the disc to be produced with the rear panel SW2 (Refer to page 10).

- Set the digital copy permit/prohibit for the disc to be produced with the rear panel SW2 (Refer to page 10).

Be sure to set this before recording

(Even if SW2 is changed during recording, it will record according to the initial setting). Depending on the setup content, the COPY BIT indicator will be displayed as follows:

Lighted: Digital recording is possible for any number of times.

Extinguished: Digital recording is possible only once (Compliance to SCMS).

Blinking: Digital recording is prohibited.

- After loading the disc, check that the **CD-R** Indicator stops blinking and lights steadily.

It does not light steadily or a character display appears, please refer to page 38.

- Select **AES EBU, COAX or OPTI**.
- The CR200 will enter the record-pause mode.
- Wait until the time information is displayed.
- Which copy bit the CR200 is in can be confirmed by the COPY BIT indicator.
- In case digital input is not input, "Un LOCK" is displayed and recording will not start. Refer to page 38.

- 1 Load a CD-R disc that contains recordable space.

- 2 Select the input to be recorded with the **INPUT SELECTOR**.

- 3 Press the **RECORD** button.

- 4 Select "Automatic track number renewal" or "manual renewal" with the **AUTO/MANUAL** button.

- 5 Start playing the source player to confirm whether recording of that source is possible.

- 6 Press the **pause** or **play** button. When recording starts, start playing the source player.

- 7 For manual renewal of the track number, press the **(MANUAL) WRITE** button (pressed when the track number is to be changed).

- 8 After recording, press the **stop** button to end recording.

MAKING A RECORDED DISC PLAYABLE ON A CD PLAYER (FINALIZATION)

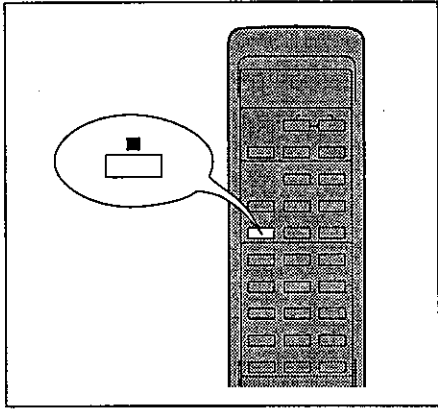
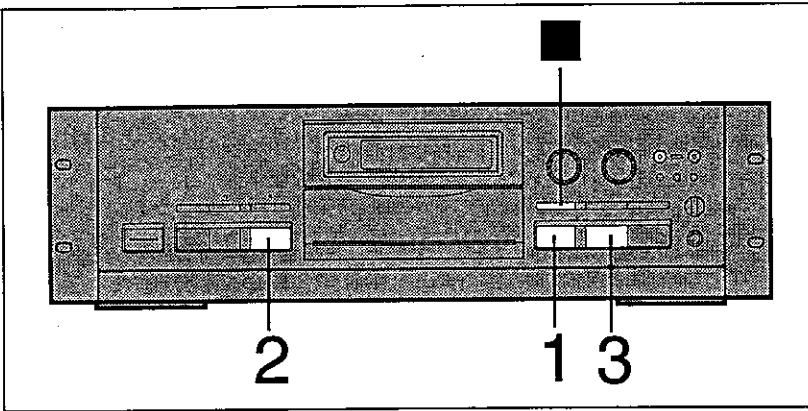

What is finalization?

- * Finalization is the final processing to make a recorded CD-R disc playable on ordinary CD players.
- * Once a disc is finalized, neither recording nor skip ID setting/clearing is possible on the disc; so be careful.
- * Never turn off the power supply during finalization, for this may lead to disc damage.

Finalization procedure

1 Load a CD-R disc which has been recorded.

2 Press the **FINALIZE** button.

Wait until the time information is displayed.

3 Press the **PAUSE** button.
Finalization starts now,

- * Ensure that there is no scratch, dust or stain on the disc.
If the disc is dusty or stained, clean it by referring to "Disc maintenance" on page 9.
- * If finalization is not required, press the **stop** button; finalization will be aborted.
- * Displayed time varies depending on discs.
- * The remaining time until the completion of finalization is displayed during finalization.
- * It usually takes about 4 minutes to complete finalization.
- * When finalization is completed, normally the CD-R indicator goes out and the CR200 enters stop mode automatically.

CAUTION:

- * Once finalization is started, no operation button is accepted until finalization is completed.
- * If a scratched, stained or dusty disc is subjected to finalization, finalization might not complete.
In case finalization does not complete in about 10 minutes from the start, the process can be aborted by pressing the **stop** button. Such a disc cannot be played on ordinary CD players.
- * Never unplug the power cord during finalization.
If the power supply is interrupted due to power failure or by mistake during finalization, the remaining finalization resumes as soon as the power supply is recovered. In this case "RESUME" is displayed until the finalization is completed.
Note that disc finalization may not resume properly in some cases.

PLAYBACK

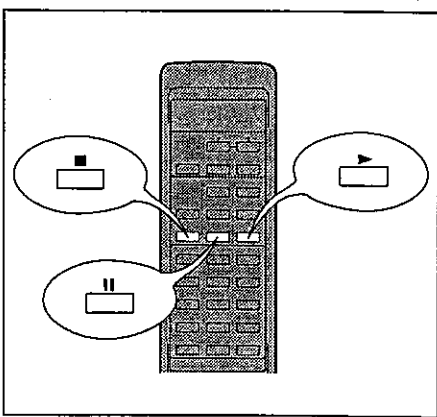
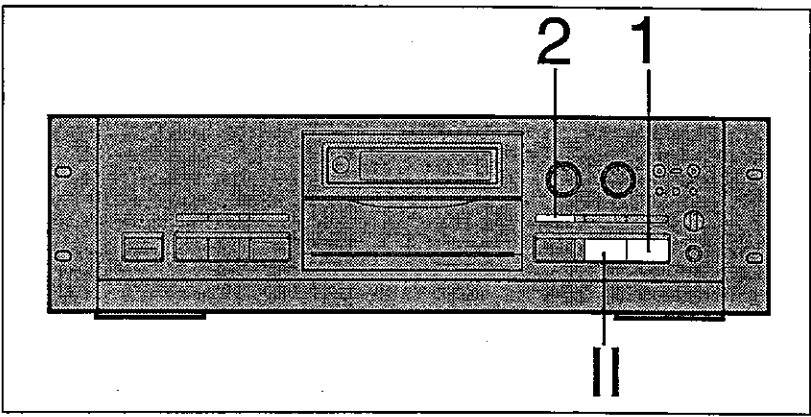

Starting playback

1 Press the **play** button.

2 To stop playback, press the **stop** button.

Place the disc on the turntable with the label side facing downward.

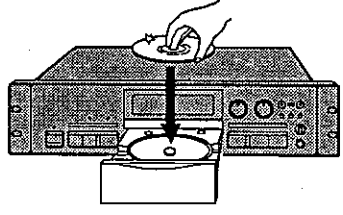

- Press the **pause** button to pause playback temporarily.
- To end pause and restart playback, press the **play** or **pause** button.
- Signals will not be output when a CD-ROM is played back in the CR200. In this case, the time display and "ROM" will be alternately displayed.

Playing from the desired track (Direct track selection)

Select the desired track using the **numeric buttons** of the remote control unit.

(Example) To select track No. 26

- Press in order of (>10), (2) and (6).

- To select track No. 1 to 10, simply press the corresponding button.
- To select track No. 11 or higher, press the >10 button first.
- A higher track No. than the total number of tracks on the disc cannot be selected.

NOTE

When selecting a track number, press the numeric buttons at intervals of less than 5 seconds.

PLAYBACK

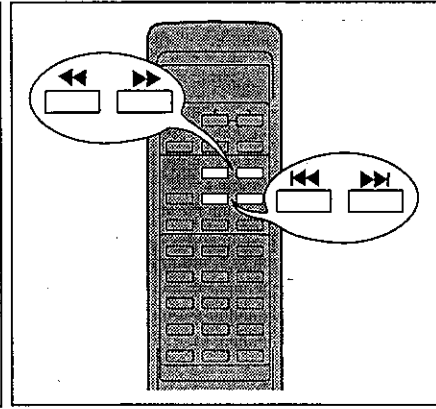
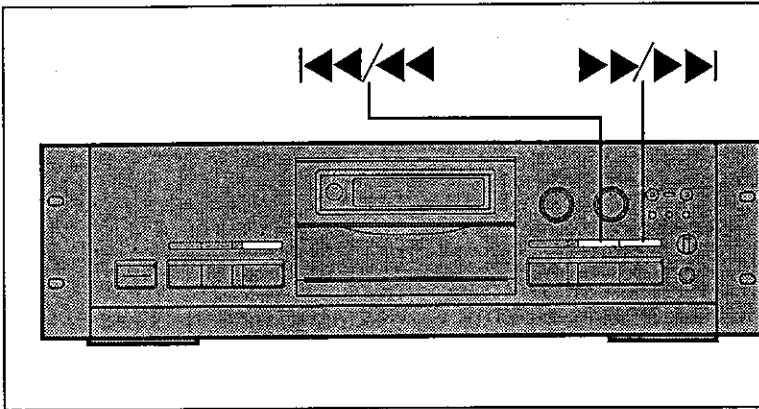

Each of the  and  buttons of the CR200 provides two functions, as a track search button or a manual search button.

Searching an adjacent track (Track search)

Press the **track search** button ().

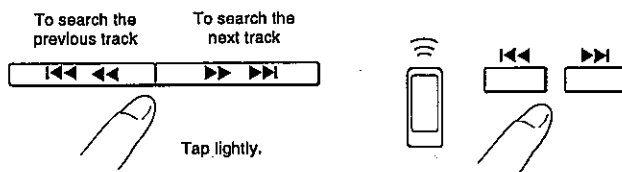

- * Pressing **>>|** during playback (including programmed playback) or when playback is paused or stopped skips the played position to the beginning of the next track. To skip to a track located after the next track, press **>>|** of the CR200 for the required number of times or press and hold **>>|** of the remote control unit. When programmed playback is activated, pressing **>>|** skips to the next track in the program.

- * Pressing **|<<** skips the played position to the beginning of the current track. To skip to a track located before the current track, press **|<<** of the CR200 for the required number of times or press and hold **|<<** of the remote control unit. When programmed playback is activated, pressing **|<<** skips to the previous track in the program.

Searching the desired point (Manual search)

Press and hold the **manual search** button ().

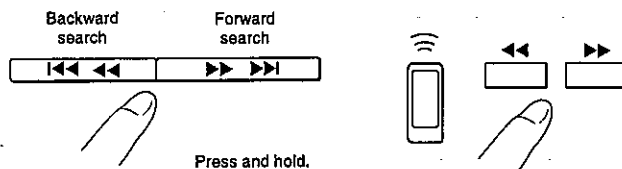

- * If the **|<<** button is pressed twice during playback of the first track or when playback is in the stop mode, the CR200 will return to the last track. However, it will not go from the last track to the first track by pressing **>>|**.

- * Pressing and holding **>>** of the CR200 during playback (including programmed playback) or when playback is paused moves the played position in the forward direction at high speed. With the remote control unit, pressing and holding **>>** during playback (programmed playback) or pause mode moves the played position in the forward direction at high speed. When a disc has been searched until the end, **"END"** is displayed and the CR200 enters the pause mode, which can be released by pressing **<<**. Pressing and holding **<<** moves the played position in the reverse direction at high speed. When a disc has been searched in the reverse direction until the beginning, the CR200 will enter play mode.

- * During programmed playback, only the current track being played can be searched in the forward or reverse direction. When the current track has been searched in the forward direction until the end, the CR200 will enter the pause mode at a position immediately before the next track; press the **play**, **pause** or **<<** button to release the pause mode. When the current track has been searched in the reverse direction until the beginning, programmed playback restarts from the position immediately before returning to the previous track.

CONVENIENT FUNCTIONS FOR RECORDING (1)

*** Recording from the middle of a disc**

If a CD-R disc before finalization has some remaining recording time left and the total number of tracks which have been recorded is below 99, recording can be restarted from a position after the last recorded track. Follow one of the recording procedures described on pages 18 to 23.

*** Checking the remaining recording time**

Press the **TIME** button in record or record-pause mode to display the remaining recording time on the disc.

*** Checking the recording condition and recording end point before recording from the middle of a disc**

1 Press the **RECORD** button to initiate the record-pause mode.

2 Press and hold the reverse manual search button. The played position is moved backward and reverse play sound is heard while the button is held depressed. When the button is released, the previous recording is played until the end point, where the CR200 enters record-pause mode again.

If you need to use automatic digital source synchro recording, press the **DIGITAL SYNCHRO** button so that the synchro recording standby display appears.

- * Holding the button depressed allows you to move the played position backward by about 2 minutes from the recording end point.
- * Pressing the **REC** button during playback puts the CR200 back to record-pause mode again.
- * Pressing the **>> >>I** button of the CR200 or **>>** button of the remote control unit allows forward track search of the recording end point or manual search.

*** Caution in case the power supply is cut off during recording**

Never turn the power supply off during recording. Be sure to always remove the disc before turning the power off.

In case the power supply is interrupted due to power failure or unplugged by mistake during recording; the rest of the recording will not be possible. In this case, "RESUME" will be displayed until recording is again possible.

*** Caution in case digital input is interrupted during recording**

In case the sampling frequency from the digital signal of DAT, DCC or satellite broadcasting is switched during recording, the digital input is interrupted but recording will continue. A non-recorded blank is recorded in this period.

In case the satellite broadcasting signal is interrupted, the digital signal line is disconnected, or the power supply of the source player is cut off, if the digital signal is recovered in less than about five seconds, recording is continued while recording a non-recorded blank in this period. If the digital signal is not recovered in five seconds or more, recording will be interrupted. "UnLOCK" will be displayed and the "II" indicator will blink; the CR200 will return to the time display and recording will restart when a digital audio signal is input after recovery of the digital signal. If the CR200 need not be restarted, press the pause button to light the "II" indicator.

*** Note on non-audio signals**

The CR200 is designed exclusively for recording audio signals. Non-audio signals such as the CD-ROM play signal cannot be recorded. Recording is possible only when the input digital signal is an audio signal. Even when a digital signal contains a graphic or character information signal, for example the CD graphics play signal is input, any graphic or character information will not be recorded.

CONVENIENT FUNCTIONS FOR RECORDING (2)

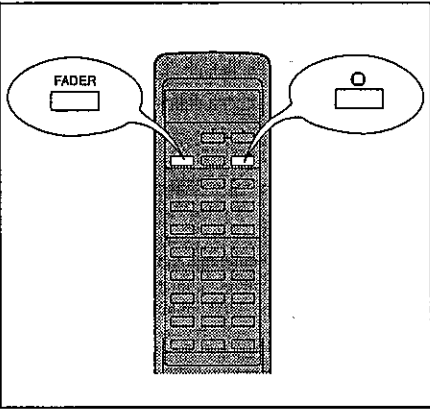
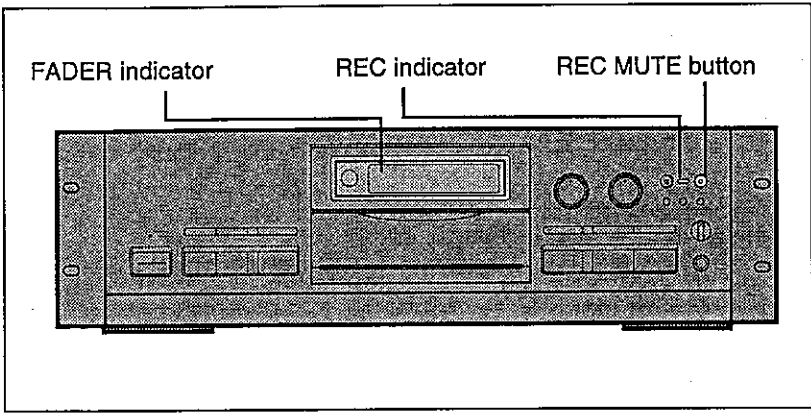

*** Creating a non-recorded blank**

*** To create a blank at the end of a recording:**
 Press the **REC MUTE** button during recording. The REC indicator blinks and a blank is recorded. The CR200 automatically enters record-pause mode in about four seconds.

*** To create an independent silent track of four seconds**
 When the **REC MUTE** button is pressed in the record-pause mode, a track composed of four seconds of silence is recorded independently then the CR200 returns to the record-pause mode. (This makes a blank four second track.)

*** Starting recording with fade-in**

Press the **FADER** button in record-pause mode.
 Recording starts by gradually increasing the recording level. The FADER indicator blinks during this time.

*** Ending recording with fade-out**

Press the **FADER** button in record mode.
 Recording ends by gradually decreasing the recording level. The FADER indicator blinks during this time. Recording ends in about five seconds from when the button is pressed.

* Fade out will become functional only after an elapse of more than four seconds from start of the recording.

*** Ending disc recording with fade-out**

When the remaining recording time falls below three seconds, fade-out starts automatically and recording is ended. This prevents a sudden interruption of sound during playback of the recorded disc.

*** Preventing recording of unnecessary blanks**

During digital source recording:
 If the digital audio signal input is interrupted for around 30 seconds during recording, recording will stop automatically and the CR200 will enter the record-pause mode. This prevents the recording of unnecessary blanks.

*** Minimum recording time per track**

As the CD specifications dictate that each CD track should be no less than four seconds, even when the pause or stop button is pressed in less than four seconds from the start of recording, recording does not pause or stop until a four second track is created by leaving a non-recorded blank. The next operation cannot be done until a four second track has been created.

CONVENIENT FUNCTIONS FOR RECORDING (3)

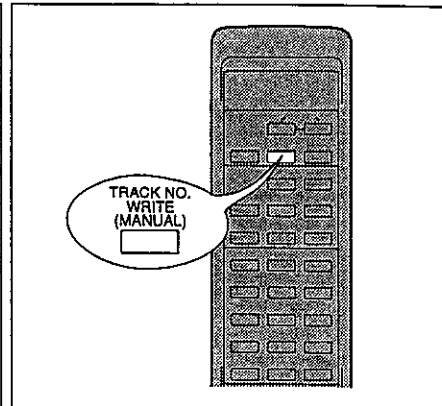
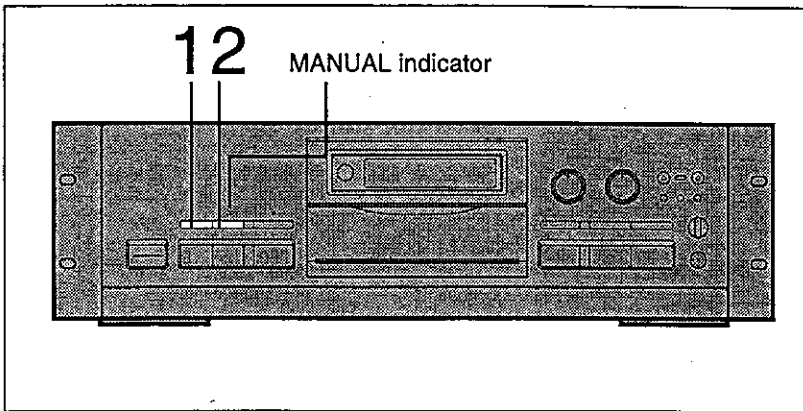

* Manual writing of track number

1 Press the **TRACK NO. AUTO/MANUAL** button so that the **(MANUAL)** indicator lights.

2 Press the **(MANUAL) WRITE** button at the position where you want to renew the track number during recording.

- The **(MANUAL) WRITE** button won't work when the **(MANUAL)** indicator is not lit.
- The track number can be renewed by pressing the **(MANUAL) WRITE** button when recording has elapsed for four seconds or more.
- Once a track number has been written, it cannot be modified or changed.
- The renewal time for the track number will be recorded by reverting approximately 300ms (0.3 seconds) from when the **(MANUAL) WRITE** button is pressed.

* Automatic writing of track number

1 Press the **TRACK NO. AUTO/MANUAL** button so that the "AUTO TRACK" indicator lights.

2 Press the **(MANUAL) WRITE** button at the position where you want to renew the track number during recording.

- At input of digital signals in the consumer format (when a source which is displayed as "INPUT," "CD," "MD," "DCC" or "DAT" when the input is monitored) the track number will be automatically renewed by detecting the space between the music signals and digital subcode signals which are input.
- If the space between tracks is extremely short, the track number may not be advanced.

CAUTION

When analog source recording, if a track contains a section where the level is too low to be sensed by the level meter, track numbers might be written incorrectly. To prevent this, we recommend using the manual writing function.

SKIPPING UNDESIRE TRACKS (RECORDING OF SKIP ID SETTING DATA)

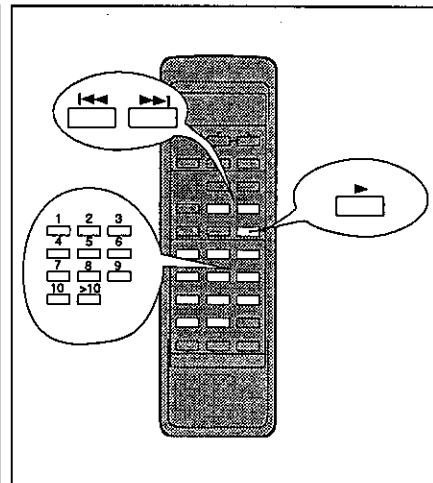
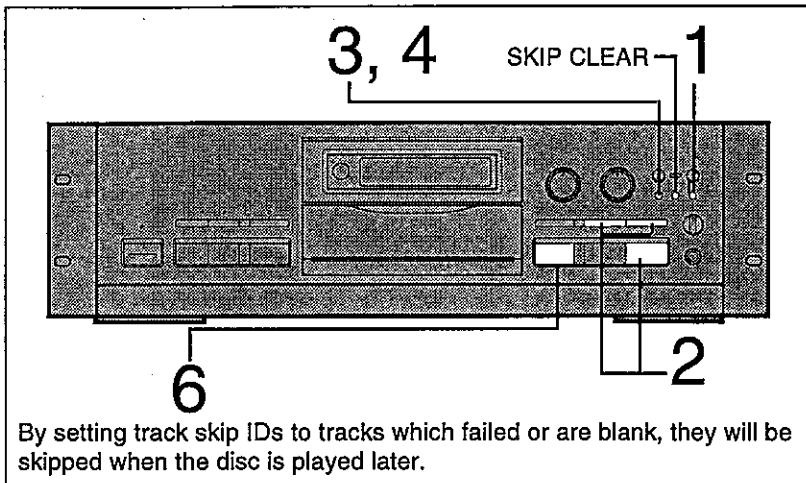

Setting skip ID to a track (Track skip)

1 Press the **SKIP PLAY ON/OFF** button to turn the SKIP ON indicator off.

2 Play the track to be skipped. Select it with the **numeric** buttons or a **track search** button (I<< or >>I) of the remote control unit, then press the play button.

3 Press the **SKIP SET** button.

"SKIP" and "SET?" are displayed alternately.

4 To set the skip ID, press the **SKIP SET** button again.

5 Skip IDs can be set to other tracks by repeating steps 2 to 4 for each of them.

6 After having set the required skip IDs, press the **OPEN/CLOSE** button.

- Skip IDs cannot be set or cleared on CD discs or finalized CD-R discs.
- With a CD-R disc which does not contain skip IDs, the SKIP ON Indicator will not light even when the SKIP PLAY ON/OFF button is pressed.
- If skip IDs have already been set, the SKIP Indicator lights on the display.
- When the track search button (I<< or >>I) is pressed while "SKIP" and "SET?" are displayed, tracks to which the skip IDs are not set will be played in order of track numbers.
- The selected tracks play back repeatedly.
- The skip ID is set by the second press.
- When the play button or SKIP CLEAR button is pressed during the setting operation, the setting mode is canceled.
- When an attempt is made to set or clear more skip IDs than possible, "FULL" is displayed and no more recording is possible.
- When the eject button is pressed to remove the disc, the skip ID setting data is recorded on the disc at this time, and blinks. "OPEN" is displayed for a few seconds, and the tray opens after the skip ID setting data has been recorded.

CAUTION:

Skip IDs can be set or cleared for up to a total of 21 tracks. If skip IDs are set or cleared repeatedly, the number of tracks to which track skip IDs will decrease. Skip IDs cannot be set or cleared with CD discs or finalized CD-R discs.

SKIPPING UNDESIRE TRACKS (RECORDING OF SKIP ID CLEAR DATA)

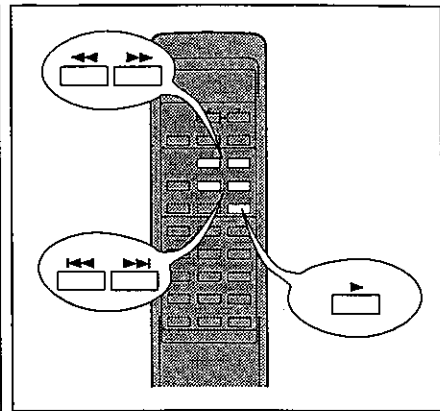
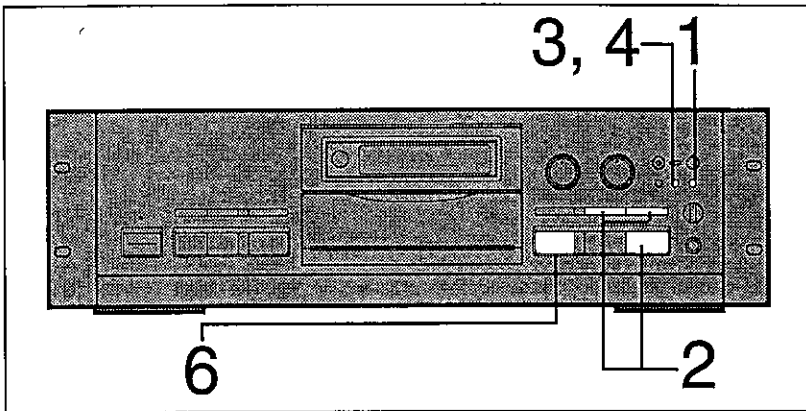

Clearing skip ID of a track

1 Press the **SKIP PLAY ON/OFF** button to turn the SKIP ON indicator off.

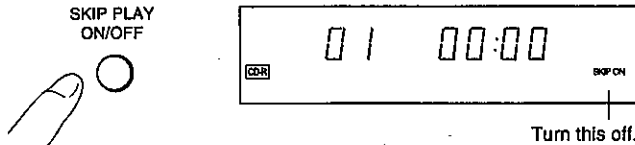

2 Play the track to be skipped. Select it with the **numeric** buttons or a **track search** button (I<< or >>I) of the remote control unit, then press the play button.

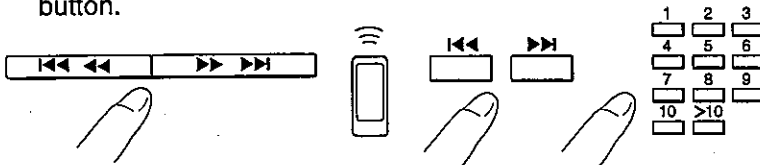

3 During playback of the track which is not to be skipped, press the **SKIP CLEAR** button.

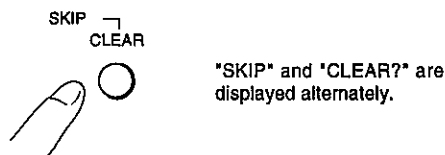

4 To clear the skip ID, press the **SKIP CLEAR** button again.

5 Skip IDs can be cleared from other tracks by repeating steps 2 to 4 for each of them.

6 After clearing the required skip IDs, press the **OPEN/CLOSE** button.

* Skip IDs cannot be set or cleared with CD discs or finalized CD-R discs.

* When the **track search** button (I<< or >>I) is pressed while "SKIP" and "CLEAR?" are displayed, tracks to which the skip IDs are set will be played in order of track numbers.
 * The selected tracks play back repeatedly.
 * If you press the **SKIP CLEAR** button during playback of a track without a skip ID, the CR200 searches for the nearest track with a skip ID and starts playback.

* The skip ID is cleared by the second press. To cancel the clearing mode, press the **play** button or **SKIP SET** button.

* If the eject button is pressed to remove the disc, the skip ID clear data is recorded on the disc at this time, and blinks. "OPEN" is displayed for a few seconds, and the tray opens after the skip ID clear data has been recorded.

PLAYBACK

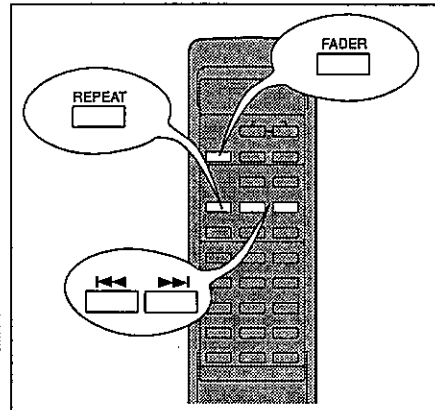
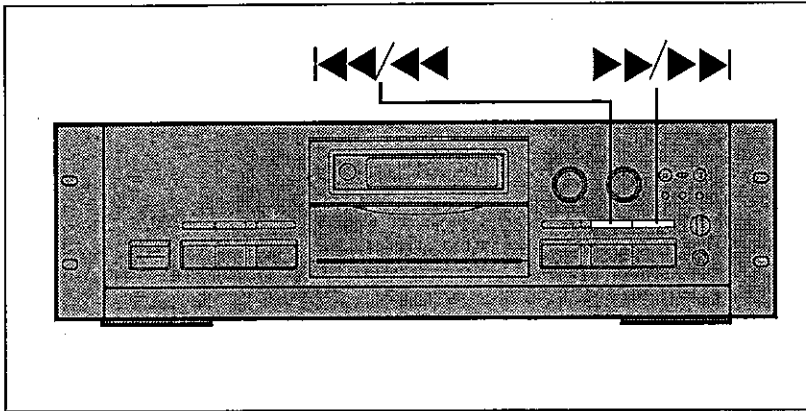

Playing tracks repeatedly (Repeat playback)

Press the **REPEAT** button of the remote control unit.

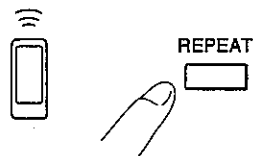

- * Pressing once initiates 1-track repeat and the REP-1 indicator lights. In this mode, the track being played is played repeatedly. This is possible in normal play, programmed play and random play modes.
- * Pressing twice initiates all-track repeat and only the REP- indicator lights. In this mode, all tracks are played repeatedly.

- * In normal play mode, all tracks on the disc are played repeatedly (all-track repeat).
- * In programmed play mode, all tracks in the program are played repeatedly in the order they are programmed.

Checking the playing time of each track (1-track time display)

If the **>>|** button is pressed in the stop mode, each press displays the playing time of each track in order of track numbers. Pressing the **|<<<** button displays the playing times in the reverse order.



- * The SKIP indicator lights for tracks to which skip IDs have been set.
- * When **|<<<** is pressed while the first track play time is on display, the last track play time will be displayed. However, pressing **>>|** will not go from the last track to the first track. Temporarily pressing the **stop** button to return the CR200 to the stop mode display, and then pressing the **>>|** button, will display the first track play time.

Fade-in/fade-out during playback

- * If the **FADER** button is pressed during pause, playback restarts with fade-in.
- * If the **FADER** button is pressed during playback, fade-out starts and playback pauses after fade-out.

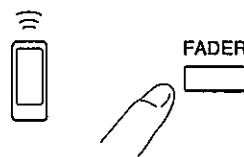

- * The fade-in and fade-out periods are both about five seconds.
- * Fade-in and fade-out are not applied to the digital outputs.

SKIPPING UNDESIRE TRACKS (SKIP PLAYBACK)

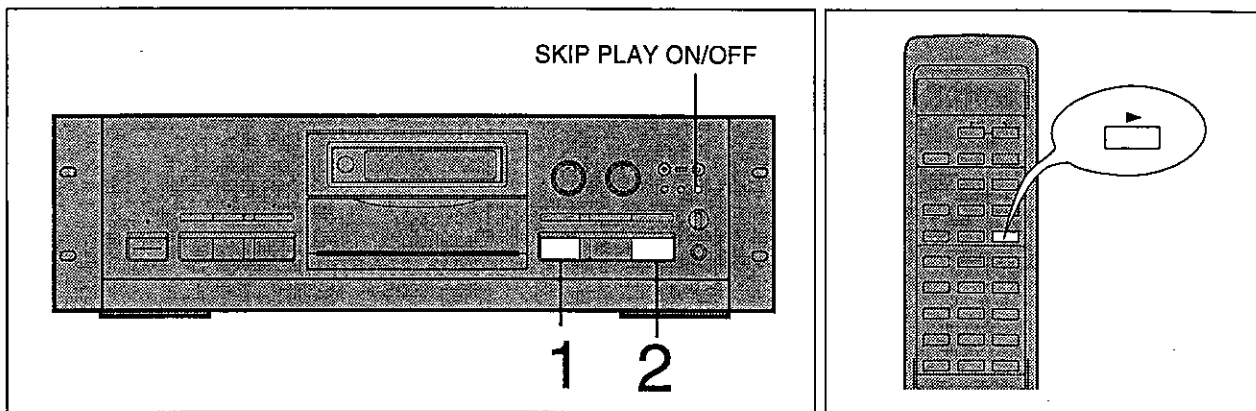

Skip playback

By setting skip IDs to the tracks which you do not want to play, these tracks can be skipped when the disc is played.

Skip playback procedure

1 Load a disc containing recording skip ID data.

2 Press the **play** button.

- * If the disc contains skip ID data, the SKIP ON Indicator will light automatically.
- * If the disc does not contain skip ID data, the SKIP ON indicator will not light.

- * The disc will play by skip tracks to which skip IDs have been set.

* In case skip playback is not required
Discs containing tracks to which track skip IDs have been set can also be played without skipping them. Just press the **SKIP PLAY ON/OFF** button to turn the SKIP ON indicator off before playing the disc.
The **SKIP PLAY ON/OFF** button is not work if the disc contains no skip ID data.

NOTE:

Skip playback is not possible with an ordinary CD player which does not have a skip function.

PLAYING TRACKS IN THE DESIRED ORDER (PROGRAMMED PLAYBACK)

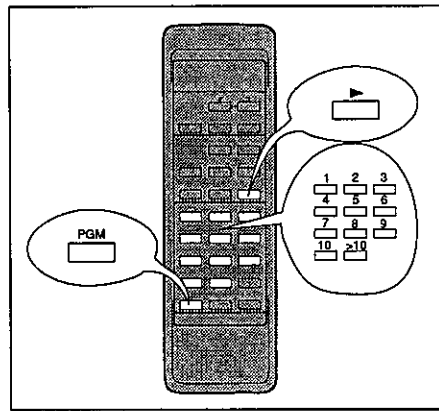
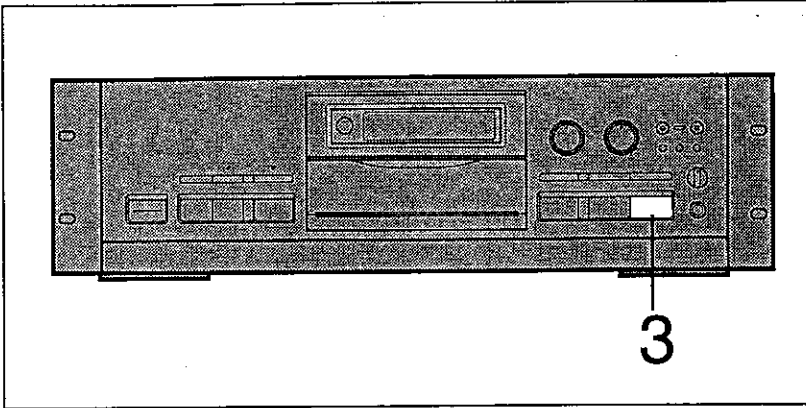

Programming tracks

1 Press the **PGM** button of the remote control unit.

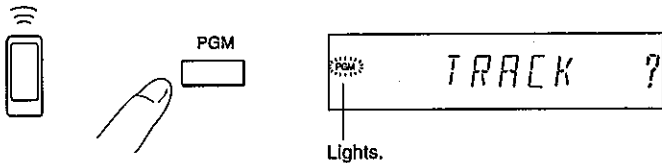

2 Use the **numeric** buttons of the remote control unit, to select the tracks in the order you wish to play them.

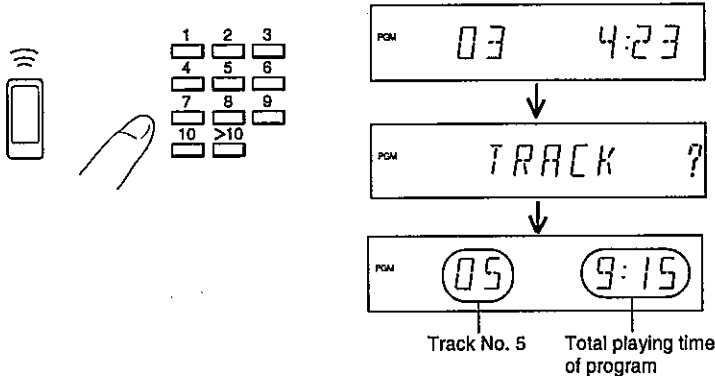

3 Press the **play** button. The tracks are played in the order they are programmed.

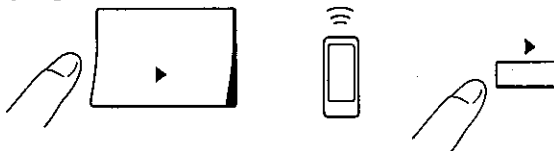

- The PGM Indicator lights.

- If stop is the current mode, each track can also be programmed by selecting its track number with the << or >> button and pressing the PGM button.
- If the **pause** button is pressed during programming in stop mode, a pause is programmed. But, a pause cannot be programmed as the first step of a program.)
- Up to 24 tracks can be programmed. A pause is also counted as one track.
- If total playing time of the programmed tracks is 100 minutes or more, the total playing time is not displayed.

- Even during programmed playback, tracks can be added to the program by selecting them with the **numeric** buttons.

Program reservation

If tracks are programmed by pressing the PGM button during normal playback, the programmed tracks will be played from the beginning automatically after the normal playback has completed. Programmed playback can also be started from the beginning by just pressing the PLAY button before the normal playback completes.

PLAYING TRACKS IN THE DESIRED ORDER (PROGRAMMED PLAYBACK)

Clearing the entire program

The program can be cleared using either A or B below.

A Press the **stop** button to stop programmed playback, then press the **stop** button again.

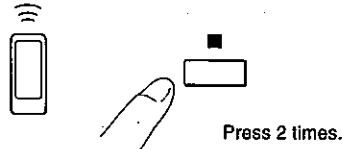

B Press the **OPEN/CLOSE** button.

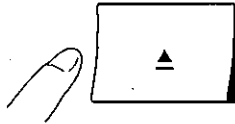

Clearing a track from the program

Press the **CLEAR** button of the remote control unit.

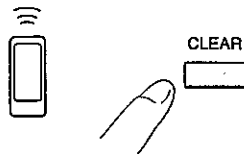

- * Each press clears the newest track in the program.
- * If the button is pressed during programmed playback, the tracks after the track being played can be cleared.

Checking the programmed tracks

Press the **CHECK** button of the remote control unit.

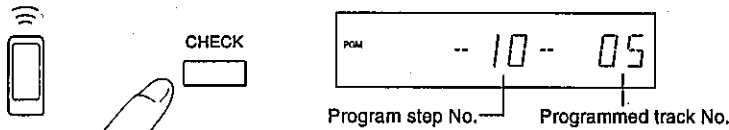

- * This operation is available in the stop mode and after tracks have been programmed. If the programmed tracks are being played, stop playback before proceeding to this operation.
- * Each press displays the track number programmed for each step of the program. When the button is pressed while the last step of the program is displayed, "00" will be displayed. Press again to display the first program step.

Replacing a track in the program

1 Press the **CHECK** button of the remote control unit the required number of times until the program step with the track number to be replaced is displayed.

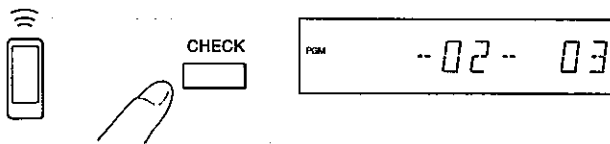

2 Select the new track number with the **numeric** buttons.

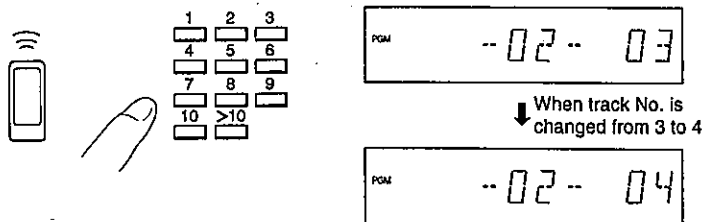

3 Other tracks can also be replaced by repeating steps 1 and 2.

- * This operation is available in stop mode and after tracks have been programmed. If the programmed tracks are being played, stop playback before proceeding to this operation.

- * Track numbers can also be selected with the **I<<** or **>>I** button.

CHARACTER MESSAGE LIST

Message	Description	Ref. Page
OPEN	The tray is being opened.	p. 16
CLOSE	The tray is being closed.	p. 16
"SET" "UP"	The CR200 is performing initial setup for recording. Please wait.	
"TOC" "READ"	The CR200 is reading the TOC of the disc. Please wait.	p. 24
1-SYNC	The CR200 is standing by for 1-track automatic digital recording. Recording will start in synchronism with the start of the player.	p. 18
AL-SYNC	The CR200 is standing by for all-track automatic digital recording. The recording will start in sync with the start of the player.	p. 19
ID-SYNC	The CR200 is standing by for all track synchro digital recording from consumer DAT. Recording will begin the start of DAT playback.	p. 20
"MONI" "AnALOG" (AES EBU, COAX, OPT)	The CR200 is monitoring input selected with the input selector.	p. 17
"INPUT" "CD" (MD, DAT, DCC)	The CR200 displays the source it is monitoring (for CD, MD, DAT, and DCC).	p. 17
"TRACK ?"	The current operation is the track programming operation. Select a track with the numeric buttons or <<, >> buttons.	p. 34
"SKIP" "SET?"	The current operation is the track skip setting operation. If you want to skip a track, select it with the SKIP ID SET button.	p. 30
"SKIP" "CLEAR?"	The current operation is the track skip clear operation. If you want to clear the skip designation of a track, select it with the SKIP ID SET button.	p. 31
ROM	When this is displayed after reading TOC, it means there is a ROM data track on the disc. If time and ROM are alternately displayed during playback, it means that the track being played back is ROM data.	p. 6, 25
STAND BY	It takes about one minute from power switch on until the CR200 is ready to record because time is required to make automatic adjustments for recording (Please wait).	p. 17

In addition to above, other character messages are also displayed as the CR200 detects troubles during use. For other character messages than above, refer to "Self-diagnostics function" on page 38.

INDEX

Term	Function	Ref. Page
CD-R disc:	Compact Disc - Recordable.	p. 8
Skip:	Refer to "Skipping undesired tracks".	p. 30, 31
Skip ON/OFF:	Switching on/off the function to skip undesired tracks to which skip IDs have been set.	p. 33
TOC:	Table Of Contents of a disc, which allows it to be played on ordinary CD players.	p. 24
Track number updating:	Function which, either automatically or manually, update the track number of the track being recorded by one digit.	p. 29
Digital synchro recording (automatic digital recording):	Function which starts/stops recording automatically by detecting the play/stop modes of a digital component.	p. 18-20
Disc identification:	Operation of check whether the loaded disc is a CD or CD-R.	p. 16
Disc damage:	Phenomenon when recording and playback of the disc become impossible due to physical shock or power failure during recording.	p. 24
Fader:	Function for recording or playing sound by smoothly varying the volume.	p. 28, 32
Finalization:	Operation for making a recorded CD-R disc playable on ordinary CD players.	p. 24
Write-once:	A CD-R disc can be recorded only once and the recording cannot be erased. Recording always starts from the end of previous recording.	p. 17
Label side:	The disc side on which letters, etc., are printed.	p. 9, 16
Remaining recording time:	The amount of time in the disc's non-recorded section where recording is possible.	p. 27
Record standby:	The REC/PAUSE mode whereby recording can be started immediately upon pressing the PLAY or PAUSE button.	p. 21, 23, 27, 28
Total recording time:	Time of the disc's recorded section.	p. 15
RESUME:	Operation initiated in case of recording failure, to recover the disc and enable the next recording.	p. 24, 27, 38
Non-recorded section:	Blank without music signal between two tracks.	p. 28

TROUBLESHOOTING

In case of trouble, please first check the following list. What seems to be a failure of the CR200 is sometimes due to imperfect maintenance, a defective disc or incorrect operation. If your problem cannot be fixed after checking the following list, please call you nearest FOSTEX service station.

Self-diagnostics

This CR200 incorporates a self-diagnostic function.

When it detects trouble during an operation, it displays one of the following messages on the display panel.

Display	Cause	Treatment	Ref. Page
Alternate display of "CHECK" and "DISC"	The disc is stopped due to dirt, stain, scratch or vibration.	Take out the disc and check for dirt, dust, scratch, etc.	page 9
	The disc might be loaded upside down.	Take out and check the disc. If the same messages are displayed again after the disc is reloaded, unplug the power cord and plug it in again. If the same messages are displayed again, try another disc. If that dosen't fix the problem, please contact a Fostex authorized service station.	page 16
Display blinks "CHECK"	A system error occurred perhaps due to noise or static electricity.	Unplug the power cord and plug it again. If the same messages are displayed again, please contact a Fostex authorized service station.	page 10-12

Information messages related to recording operation

Display	Cause	Treatment	Ref. page
"UnLOCK"	Digital input is cut. Or, a digital signal of a format which cannot be recorded has been input.	Check if the digital input is disconnected or wiring broken, or if the power to the transmitting equipment is off. Also check the digital signal output format from the transmitting equipment.	page 10, 11
Cyclic display of "CHECK", "INPUT" and "CD".	The source player was already playing when the DIGITAL SYNCHRO button was pressed.	Stop playing the source player. In a while, "1-SYNC" or "AL-SYNC" will be displayed and synchro recording will start.	page 18-20
Alternate display of "SET" and "UP".	The CR200 is making preparations for recording.	Wait until these messages disappear.	
"REPAIR"	Because the disc was left in the CR200 after recording and the power plug was unplugged later, the track number and recording time data have been cleared before being recorded on the disc.	While "REPAIR" is displayed, the track number and recording time data are repaired by tracking the recorded area. Further recording or finalization is possible when the display returns to the previous condition. Tracing of the recorded area takes about 40 minutes if the disc has been recorded fully.	
"REC FULL"	No more recording is possible because the available recording time of the disc has been used, or 99 tracks have already been recorded on the disc.	Replace the disc with a new one.	page 17
Cyclic display of "CHANGE" and "DISC".	This is a special purpose CD-R disc.	Replace with a commercial or consumer type CD-R disc. Remove the disc and check the type.	page 8

Information messages related to playback operation

Display	Cause	Treatment	Ref. page
"NEW DISC"	A blank disc has been loaded. Trying to playback a blank disc..	The loaded disc is a blank CD-R disc. Recording is possible but playback is not.	page 8, 16
"NO DISC"	Playback without loading a disc.	Open the tray and check to see if a disc is loaded.	page 16
"RESUME"	The CR200 is resuming operation. If the power supply is cut off by a power failure or by mistake during recording, the CR200 enters RESUME mode so that additional recording is possible.	Wait until the message disappears.	page 24-27

TROUBLESHOOTING

Symptom	Cause	Remedy
Power cannot be turned on.	The power cord is unplugged from the power outlet.	Plug the power cord into a power outlet.
	The power was turned off from the component (stereo amplifier, audio time, etc.) to which it is connected.	Turn on the component into which the power cord is connected.
Playback is impossible.	Signal connections are incorrect.	Make connections properly as indicated in "Connections with other equipment".
Recording is impossible.	Signal connections are incorrect.	Connect properly as indicated in "Connections with other equipment".
	The CD-R disc in use has been finalized.	Use a non-finalized disc.
	The input selection is incorrect.	Select the input connected to the desired source.
	The REC LEVEL control is set too low.	Increase the recording level to an optimum level.
Recorded sound is distorted.	Signal connections are incorrect.	Connect properly as indicated in "Connections with other equipment".
	There is interference from a TV set.	Turn the TV power off or move the CR200 away from the TV.
	The recording level is set too high.	Decrease the recording level.
	The disc is damaged or warped.	Use another disc.
Remote control operation is impossible.	The disc is extremely dirty.	Clean the disc.
	The remote control batteries are dead.	Replace both of the remote control batteries with new ones.
	There is an obstacle between the remote control unit and the CR200.	Remove the obstacle.
Certain tracks are skipped without being played.	The remote control unit is being operated outside its working range.	Operate in the remote controllable range.
	The SKIP PLAY button is set to ON.	Set the SKIP PLAY button to OFF.
Skip playback does not occur.	The SKIP PLAY button is set to OFF.	Set the SKIP PLAY button to ON.
A recorded CD-R disc cannot be played on other CD players.	<ul style="list-style-type: none"> * The disc has not been finalized after recording. * If this type of disc is loaded in the CR200, the CD-R indicator lights up. (Refer to page 8.) 	Finalize the disc. (Refer to page 24.)

SPECIFICATIONS

1. GENERAL

Model.....	Compact disc recorder
Applicable discs.....	CDs and CD-Rs
Number of channels.....	2 channels (stereo)
Power supply.....	AC 120 V, 60 Hz AC 230 ~, 50/60Hz
Power consumption.....	21 W
Weight (without package).....	6.2 kg
Max. dimensions.....	482 (W) x 294 (D) x 134 (H) mm

2. AUDIO UNIT

Frequency characteristics.....	2 Hz to 20 kHz
Playback S/N.....	110 dB (EIAJ)
Playback dynamic range.....	97 dB (EIAJ)
Playback total harmonic distortion.....	0.0027 % (EIAJ)
Playback channel separation.....	100 dB
Recording S/N.....	90 dB (analog), 105dB (digital)
Recording dynamic range.....	90 dB (analog), 95dB (digital)
Recording total harmonic distortion.....	0.005 % (analog)

Wow-flutter.....	0.003% (digital) Less than measurement limit (±0.001 % W.PEAK) (EIAJ)
------------------	---

3. INPUT/OUTPUT JACKS

Analog Input	
XLR-3-31 type (x 2)	
Standard input level.....	+4dBu/-10dBV (switchable)
Input impedance.....	10kΩ
RCA type	
Standard input level.....	-10dBV
Input impedance.....	27kΩ
Analog Output	
RCA type	
Standard output level.....	-10dBV
Load impedance.....	Higher than 10kΩ
Digital Input	
XLR-3-31 type.....	IEC958 Part 2 (AES/EBU)

RCA type.....IEC958 Part 3 (S/P DIF)
 OPTICAL type.....IEC958 Part 3 (S/P DIF)
Digital Output
 RCA type.....IEC958 Part 3 (S/P DIF)
 OPTICAL type.....IEC958 Part 3 (S/P DIF)
Parallel remote.....DIN 8pin connector

* Size AAA/R03 dry cell batteries.....2
 * Audio cable.....2
 * Power cable.....1
 * Owner's Manual.....1

NOTE:

The specifications and design of this product are subject to change without notice, due to improvements.

4. ACCESSORIES

* Remote control unit (model 8317).....1

Declaration of EC Directive

This equipment is compatible with the EMC Directive (89/336/EEC) - Directive on approximation of member nation's ordinance concerning the electromagnetic compatibility and with the Low Voltage Directive (73/23/EEC) - Directive on approximation of member nation's ordinance concerning electric equipment designed to be used within the specified voltage range.

The Affect of Immunity on This Equipment

The affect of the European Specification EN50082-1 (coexistence of electromagnetic waves - common immunity specification) on this equipment are as shown below.

** In the electrical fast transient/burst requirements, and static electricity discharging environment, this could be affected by generation of noise in some cases.*

FOSTEX DISTRIBUTORS LIST IN EUROPE

* Including non-EU countries.

* underlined>: contracted distributors (as of November, 1997)

<AUSTRIA>

NAME: ATEC Audio-u. Videogeräte VertriebsgesmbH.
 ADD: Im Winkel 5, A-2325 Velm, Austria
 TEL: (+43) 2234-74004, FAX: (+43) 2234-74074

<BELGIUM>

NAME: EML N.V.
 ADD: Bijvenestraat 1A, B3500 Hasselt, Belgium
 TEL: (+32) 11-232355, FAX: (+32) 11-232172

<DENMARK>

NAME: SC Sound ApS
 ADD: Malervej 2, DK-2630 Taastrup, Denmark
 TEL: (+45) 4399-8877, FAX: (+45) 4399-8077

<FINLAND>

NAME: Noretron Audio
 ADD: Tonttumuurinkuja 4, FIN-02200 Espoo, Finland
 TEL: (+358) 0-5259330, FAX: (+358) 0-52593352

<FRANCE>

NAME: Musikengro
 ADD: ZAC de Follouises, B. P. 609, 01706 Les Echets, France
 TEL: (+33) 72 26 27 00, FAX: (+33) 72 26 27 01

<GERMANY>

NAME: Studiosound & Music GmbH
 ADD: Scheppe Gewissegasse 8, D-35039 Marburg, Germany
 TEL: (+49) 6421-12071, FAX: (+49) 6421-15522

<GREECE>

NAME: Bon Studio S. A.
 ADD: 6 Zaimi Street, Exarchia, 106.83 Athens, Greece
 TEL: (+30) 1-3809605-8, 3302059, FAX: (+30) 1-3845755

<ICELAND>

NAME: I. D. elrf, electronic Ltd.
 ADD: ARMULA 38 108 REYKJAVIK ICELAND
 TEL: (+354) 588 5010, FAX: (+354) 588 5011

<ITALY>

NAME: Recoton Italia Srl.
 ADD: V. 1 Maggio, N 18, 40050 Quarto Inferiore, (BO) Italy
 TEL: (+39) 51-768576, FAX: (+39) 51-768336

<THE NETHERLANDS>

NAME: JEMKE ROOS AUDIO B.V.
 ADD: Kuiperbergweg 20, 1101 AG Amsterdam, The Netherlands
 TEL: (+31) 20-697-2121, FAX: (+31) 20-697-4201

<NORWAY>

NAME: Siv Ing. Benum A/S
 ADD: P. O. Box 145 Vinderen, 0319 Oslo 3, Norway
 TEL: (+47) 22-139900, FAX: (+47) 22-148259

<PORTUGAL>

NAME: Caius - Tecnologias Audio e Musica, Lda.
 ADD: Rua de Santa Catarina, 131 4000 Porto, Portugal
 TEL: (+351) 2-2084456/325400, FAX: (+351) 2-314760

<SPAIN>

NAME: Multitracker S. A.
 ADD: C/Garcilaso No.9, Madrid 28010, Spain
 TEL: (+34) 1-4470700, 1-4470898, FAX: (+34) 1-5930716

<SWEDEN>

NAME: TTS Tal & Ton Studioteknik AB
 ADD: Gelbgjutarevagen 4, S-171 48 Solna, Sweden
 TEL: (+46) 8-7340750, FAX: (+46) 8-824476

<SWITZERLAND>

NAME: Audio Bauer Pro AG
 ADD: Bernerstrasse-Nord 182, CH-8064 Zurich, Switzerland
 TEL: (+41) 1-4323230, FAX: (+41) 1-4326558

<UK>

NAME: SCV London
 ADD: 3A 6-24 Southgate Road, London N1 3JJ, England, UK
 TEL: (+44) 171-923-1892, FAX: (+44) 171-241-3644

Fostex

FOSTEX CORPORATION

3-2-35 Musashino, Akishima-shi, Tokyo 196-0021, Japan

FOSTEX CORPORATION OF AMERICA

15431, Blackburn Ave., Norwalk, CA 90650, U. S. A.